

**Optim US-L260-Omni Lithium Iron Phosphate
Battery Energy Storage System
User Manual**

Information Version: 1.0

Legal Information

Copyright©2024 Pylon Technologies Co., Ltd. All rights reserved.

Any reproduction or distribution of this manual or any part of this manual, or any uploading of this manual to a third party website, in any form by any means, without the prior written consent of Pylon Technologies Co., Ltd., is prohibited.

Disclaimer

The Manual contains instructions for the use of the product. All the pictures and charts in this manual are for description and explanation only. Pylon Technologies Co., Ltd. reserves the right to change the information in the manual which is subject to change without further notice.

Please read this manual carefully before using the product and keep this manual for further reference. Failure to use the product in accordance with the manual may result in serious injuries, property damages and may void the warranty, for which Pylon Technologies Co., Ltd. shall not be liable.

Pylon Technologies Co., Ltd. makes no representations or warranties express or implied, with respect to all the information in this manual.

In the event of any conflicts between this manual and the applicable law, the latter prevails.

The final interpretation of this manual belongs to Pylon Technologies Co., Ltd.

Contents

1	Information about this manual	1
1.1	Purpose	1
1.2	Product Name Description	1
1.3	Product Model Description	2
1.4	Explanation of Symbols	2
1.5	Abbreviations in this Manual	3
2	Safety	4
2.1	Symbols	4
2.2	Personal Requirements	5
2.3	General Requirements	6
2.4	Equipment Label Protection	7
2.5	Establishment of Safety Warning Signs	7
2.6	Precautions for Maintenance or Repairs	7
2.7	Electrostatic Protection	8
2.8	Moisture Protection	8
3	System Introduction	9
3.1	System Overview	9
3.2	System Description	10
3.3	System Specifications	11
3.4	Reference standards	13
3.4.1	System Related Standards	13
3.4.2	Battery Related Standards	13
3.5	System Components	14
3.5.1	Outdoor Cabinet	19
3.5.2	Battery String20	
3.5.3	LEMS	26
3.5.4	PCS (Metis-130-E)	30
3.5.5	Liquid Chiller (EMW50HFNC1A)	33
3.5.6	UPS (9PX1000IRT2U)	35
3.5.7	Safety Features	37
4	Mechanical Installation	39
4.1	Checking Before the Installation	39
4.2	Preparing Tools and PPE	39
4.3	Selecting the Installation Sites	40

4.3.1	Working Environment Requirements	40
4.3.2	Installation Space Requirements	40
4.3.3	Installation Foundation Requirements	42
4.4	Handling of the Cabinet	44
4.5	Mechanical Installation Steps	45
5	Electrical and Communication Wiring	46
5.1	System Electrical Diagram	47
5.2	Cable Requirements and Bolt Torque	48
5.3	Grounding	49
5.4	Battery Energy Storage System Connection	51
5.4.1	Cable List	51
5.4.2	Battery String DC Wiring	52
5.5	AC Side Cable Wiring	53
5.6	Communication Wiring Diagram	54
6	Commissioning	55
6.1	System Status	55
6.1.1	Battery String Status	55
6.2	System Turning On	56
6.3	System Debug	58
7	Maintenance	59
7.1	System Turning Off	59
7.2	Routine Maintenance	60
7.2.1	Battery Maintenance	62
7.2.2	PCS Maintenance	63
7.2.3	Liquid Chiller Maintenance	63
7.3	Trouble Shooting	64
7.3.1	Battery String Trouble Shooting	64
7.3.2	PCS Trouble Shooting	66
7.3.3	UPS Trouble Shooting	68
7.3.4	Liquid Chiller Trouble Shooting	69
7.4	Emergency Disposal (EPO)	70
8	Shipment and Storage	71
8.1	Shipment	71
8.2	Storage	71

1 Information about this manual

1.1 Purpose

This manual describes the Optim US-L260-Omni Lithium Iron Phosphate Battery Energy Storage System (hereinafter referred to as "the system" unless otherwise noted) from Pylontech in terms of its overview, installation, commissioning, maintenance, etc.

Please read this manual before installing the system and follow the instructions carefully during installation. In case of any confusion, please contact Pylontech immediately for advice and clarification (Contact information can be found on the back cover of the manual).

1.2 Product Name Description

Optim US-L260-Omni

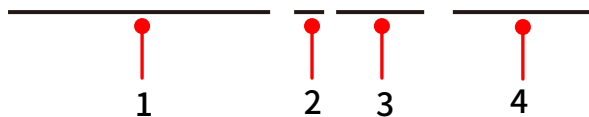

No.	Designation	Description
1	Product Series	Optim US Series
2	Cooling type of the system	Liquid Cooling
3	The rated energy (in kWh) of the system	The rated energy of this system is about 260 kWh.
4	Type of the cabinet	"Omni" represents all in one cabinet (including the PCS)."

1.3 Product Model Description

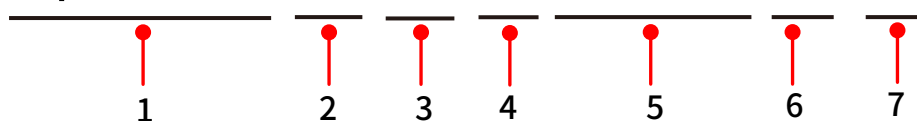

Optim US-A1-M7-A-125/261-EU-xx



No.	Designation	Description
1	Product Series	Optim US Series
2	"A" represents type of the cabinet system. "1" is the serial number.	"A" represents "all in one cabinet (including the PCS)."
3	Battery model used in the product	The product uses M7 battery.
4	Product Version	Version A
5	The rated power of the PCS (in kW) The rated energy (in kWh) of the system	The rated power of the PCS is 125 kW. The rated energy of this system is 261 kWh.
6	Sales territory	The product is intended for European market.
7	"xx" represents the fire and explosion safety configurations (Where xx=01, 02, 03, 04 or 05) *	The standard safety configuration: combustible gas detector + Explosion-proof ventilation fan

* **NOTE:** For more details of the fire and explosion safety configurations, please see *section 3.3*.

1.4 Explanation of Symbols

Symbol	Description
 DANGER	Danger: Indicates a hazard with a high level of risk which, if not avoided, will result in death or serious injury.
 WARNING	Warning: Indicates a hazard with a medium level of risk which, if not avoided, could result in death or serious injury.
 CAUTION	Caution: Indicates a hazard with a low level of risk which, if not avoided, could result in minor or moderate injury.

1.5 Abbreviations in this Manual

Abbreviation	Designation
Pylontech	Pylon Technologies Co., Ltd.
EU	European Union
AC	Alternating Current
DC	Direct Current
BMS	Battery Management System
BMU	Battery Management Unit
MSD	Manual Service Disconnect
PCS	Power Conversion System
SOC	State of Charge
SOH	Battery State of Health, in percent
UPS	Uninterruptible Power Supply
BESS	Battery Energy Storage System
EMS	Energy Management System
LEMS	Local Energy Management System
MCB	Micro Circuit Breaker
MCCB	Moulded Case Circuit Breaker
PDU	Power Distribution Unit
PMU	Power Management Unit
CMU	Control Management Unit
SPD	Surge Protecting Device
GND	Ground
DOD	Depth of Discharge
MCU	Microcontroller Unit

2 Safety

2.1 Symbols

	Read the manual before installing and operating the battery system.
	Must wear an ear protector.
	General warning label indicating potential hazards.
	Warning: electric shock.
	Warning: flammable materials.
	Do not connect the positive and negative reversely.
	Keep away from flame or ignition sources.
	Keep away from children.
	Grounding
	Recycle label.
	Label for Waste Electrical and Electronic Equipment (WEEE) Directive (2012/19/EU).
	The certificate label for CE.

2.2 Personal Requirements

This system is only operated by authorized personnel. Read all safety instructions carefully prior to any work and follow these instructions at all times when working with the system.

Incorrect operation or work may cause:

- Injury or death to the operator or a third party.
- Damage to the system hardware and other properties belonging to the operator or a third party.

Qualified personnel must have the following skills:

- Training in the installation and commissioning of the electrical system, as well as the dealing with hazards.
- Knowledge of the manual and other related documents.
- Knowledge of the local regulations and directives.

2.3 General Requirements

DANGER

Battery strings will produce high voltage DC power and can cause a lethal voltage and an electric shock. Only qualified personnel can perform the wiring of the battery strings.

DANGER

Lethal voltages are present in the battery terminals and cables. Severe injuries or death may occur if you touch the cables and terminals.

WARNING

Pulling out the connectors while the system is working could lead to battery system damage or personal injury. Do not pull out the connectors while system is in operation. De-energize all multiple power sources and verify that there is no voltage.

WARNING

Whenever operating the battery system, wear suitable personal protective equipment (PPE) such as rubber gloves, rubber boots and goggles.

WARNING

For this system, the working temperature is -25°C ~ 55°C and the optimum temperature is: 10°C ~ 40°C . Out of the working temperature range may cause the battery system over/low temperature alarm or protection which will further lead to the cycle life reduction. It will affect the warranty terms as well.

WARNING

For battery installation, the installer shall refer to IEC 60364 or similar local installation standard for operation.

CAUTION

Improper settings or maintenance can permanently damage the battery.

CAUTION

Incorrect PCS parameters will lead to the premature aging of battery or battery system failure.

There is high voltage in the system, and any accidental contact may lead to fatal electric shock. Be sure to observe the following when working with the system:

- Tag and lock the working area.
- There must be an escort to ensure personal safety.

2.4 Equipment Label Protection

- The warning labels on the outside and inside of the cabinet of this product contain important information for safe operation of this product. It is strictly prohibited to remove or damage them.
- This product is fitted with a nameplate that contains important information about the parameters related to the product. It is strictly prohibited to tear or damage it.

2.5 Establishment of Safety Warning Signs

When installing, performing routine maintenance, repairing, etc. on this product, to prevent uninvolved persons from approaching and causing accidental operations or accidents, please observe the following:

- Establish visible signs at all circuit breakers for this product to prevent accidents caused by accidental closing of the circuit breaker.
- Establish warning signage or set up safety caution tape near the operating area.
- Always remove the cabinet door key and keep it in a safe place after operations such as maintenance or overhaul.

2.6 Precautions for Maintenance or Repairs

The product can be taken out of operation smoothly by performing the shutdown operation. When performing maintenance or overhaul operations on the equipment, please observe the following:

- Ensure that this product is not accidentally repowered.
- Use a multimeter to ensure that the product is completely free of electrical charge internally.
- Ensure the proper grounding connections.
- Cover potentially energized parts of the operating section with insulation using a cloth made of insulating material.
- Ensure that escape routes are completely clear throughout maintenance and repair.

2.7 Electrostatic Protection

- Contact or improper handling of printed circuit boards or other static-sensitive components can cause damage to the device.
- Avoid unnecessary contact with the circuit board.
- Observe electrostatic protection norms, such as wearing anti-static bracelets.

2.8 Moisture Protection

- Do not open the cabinet door when the air humidity is >95%.
- Avoid installation operations in rainy or humid weather conditions.
- Intrusion of moisture will most likely damage the product.

3 System Introduction

3.1 System Overview

The Optim US-L260-Omni is a high voltage battery storage system based on lithium iron phosphate battery. This system is especially suitable for industrial and commercial application scenarios such as grid peak shaving and valley filling, power capacity increase, photovoltaic storage charging system, and backup power.

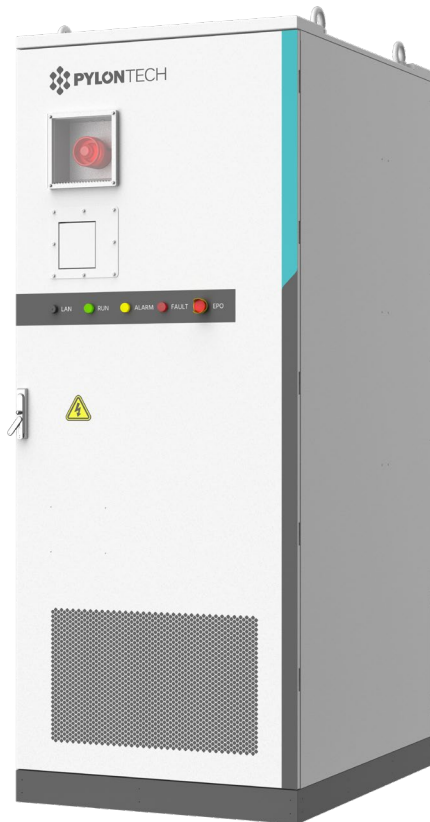

Front View

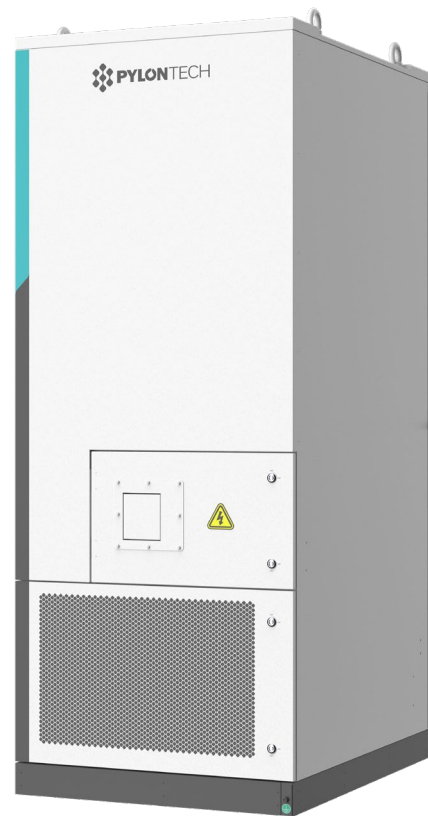

Rear View

NOTE: The above pictures are for reference only, the appearance of the product is subject to the actual delivery.

3.2 System Description

The outdoor integrated battery energy storage system connects the power grid with the storage battery through the energy storage converter PCS, and realizes the bidirectional energy transfer between the DC battery of the battery energy storage system and the AC grid by applying the principle of AC/DC conversion. It is realized through the control strategy:

- Charging and discharging management of the battery system.
- Tracking the power of the load on the grid side.
- Control of the charging and discharging power of the battery energy storage system, off-grid operation, and so on.

Main functions of the product

- Peak reduction and valley filling: it is realized by charging and discharging from the energy storage system in accordance with the requirements of the local electricity tariff with a fixed duration.
- Anti-backflow function: EMS adjusts the charging and discharging power of energy storage in real time by sampling the power of the grid to prevent backflow to the grid.
- Demand management: EMS adjusts the charging and discharging power of the energy storage system to avoid over-limit of the user's transformer.
- Local control and remote communication control.

3.3 System Specifications

Specifications	Model Name	Optim US-A1-M7-A-125/261-EU-xx (where xx=01, 02, 03, 04 or 05, represents the firefighting configuration)
Auxiliary Power Parameters	Rated Output Voltage (VAC)	220
	Max. Output Current (A)	24
	Rated Frequency (Hz)	50
AC side (On-grid)	Rated Power (kW)	125
	Rated Voltage (VAC)	400
	Rated Current (A)	181
	Max current (A)	200
	Frequency (Hz)	50
	Wiring Method	3W+N+PE
AC side (Off-grid)	Max Output Power of Load Port (kW)	125
	Wiring Method of Load Port (VAC)	380
	Max Output Current (A)	181
	Frequency (Hz)	50
	Connection Type of Load Port (Vac)	3W+N+PE
DC side Parameters	Battery String Qty. (=BMS Qty.)	1
	Battery Module Qty.	5
	Rated Capacity (Ah)	314
	Rated Energy (kWh)	261
	Rated Voltage of Battery String (V)	832
	Upper Limit Charging Voltage (V)	936
	End-of-discharge Voltage (V)	702
	Standard Charge/ Discharge Current (A)	150
	Maximum Continuous Charge/ Discharge Current (A)	196
System Parameters	External Dimensions of the outdoor cabinet (mm)	950 ± 5 (W) x 1300 ± 5 (D) x 2480 ± 5 (H)
	Weight (kg)	2900
	Handling Type	Applicable for hoist and forklift handling
	Working Temperature range (°C) *	-25~55
	Ingress Protection (IP) / Protective Class	IP55/ Class I

Specifications	Model Name	Optim US-A1-M7-A-125/261-EU-xx (where xx=01, 02, 03, 04 or 05, represents the firefighting configuration)
	Relative Humidity	0-95% RH, non-condensing
	Noise (dB)	75 @ 1 meter
	Altitude (m)	≤ 3000
	Pollution Degree	PD3 (Outside), PD2 (Inside)
	Cooling Type	Liquid Cooling
	Coolant	50% water, 50% ethylene glycol
	Nominal Operating pressure (bar)	2.0~2.2
	Maximum Operating pressure (bar)	3
	Usable Extinguishing Agent	A/B/C/F
	Fire Fighting Method	01: Explosion relief panel 02: Explosion relief panel + Sprinkler system 03: Ventilation fan 04: Ventilation fan + Sprinkler system 05: Explosion relief panel +Ventilation fan + Sprinkler system
	External Communication Protocol	Modbus-TCP、 Modbus-RTU
	Wire feeding in and out method	Bottom in and bottom out

* In high (>40°C) or low temperature (<10°C) environment, the charging and discharging power of the battery system will be limited according to BMS operation logic.

3.4 Reference standards

3.4.1 System Related Standards

No.	Description	Code
1	CE LVD Directive 2014/35/EU	EN 62477-1
2	UN38.3 Safe Transport Standard	UN38.3
3	CE EMC Standard	EN IEC 61000-6-2:2019 EN IEC 61000-6-4:2019

3.4.2 Battery Related Standards

No.	Description	Code
1	Safety Standard for Secondary Lithium Batteries	IEC62619-2022 IEC63056 IEC62477-1 IEC62040-1 ISO 13849-1
2	UN38.3 Safe Transport Standard	UN38.3
3	CE EMC Standard CE EMC Directive 2014/30/EU	EN IEC 61000-6-2:2019 EN IEC 61000-6-4:2019
4	Battery Cell Safety Standard	UL1642
5	Battery Cell Safety Standard	UL1973
6	Battery Cell Safety Standard	IEC60730-1 SIL B/II
7	Safety Standard for Electrical Devices CE LVD Directive 2014/35/EU	EN 62477-1
8	Safety Standard for Lithium Battery (Germany)	VDE2510-50

3.5 System Components

NO.	Description	Location	NO.	Description	Location
①	Cabinet Body	Figure 1	⑬	Battery Control Module	Figure 2
②	Sound-light Alarm		⑭	PCS	
③	Explosion-proof ventilation fan (air outlet)		⑮	Liquid Chiller	
④	LAN Port		⑯	UPS	
⑤	Product Nameplate		⑰	Dehumidifier	
⑥	Ventilation window (air inlet)		⑱	Smoke Detector	
⑦	Status Indicator		⑲	Combustible Gas Detector	
⑧	EPO (Emergency Power OFF Switch)	Figure 2	⑳	Temperature Sensor	Figure 3
⑨	Battery Module		㉑	Aerosol Can	
⑩	LEMS		㉒	Explosion-proof ventilation fan (air inlet)	
⑪	Black Start Button		㉓	Ventilation window (air inlet)	
⑫	Circuit Breakers		㉔	MCCB (QF2)	

NOTE:

1. The table above displays the standard firefighting configurations: combustible gas detector + Explosion-proof ventilation fan.
2. Explosion relief panel and Water fire suppression device are **OPTIONAL** firefighting configurations per your specific system.
 - Explosion relief panel is on the top of the cabinet.
 - External joint of water firefighting is on the rear door of the cabinet.

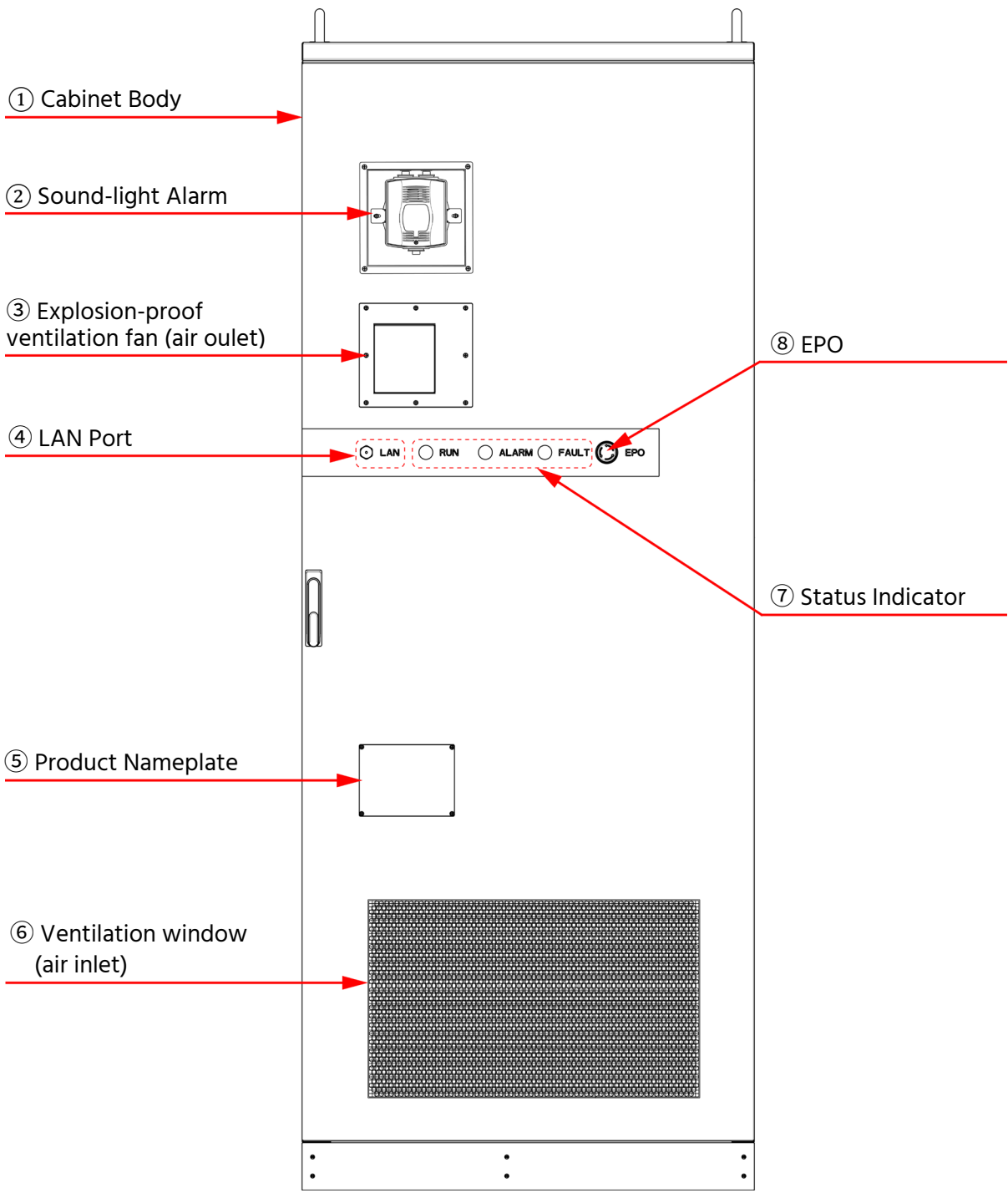

Figure 1- Front View (door closed)

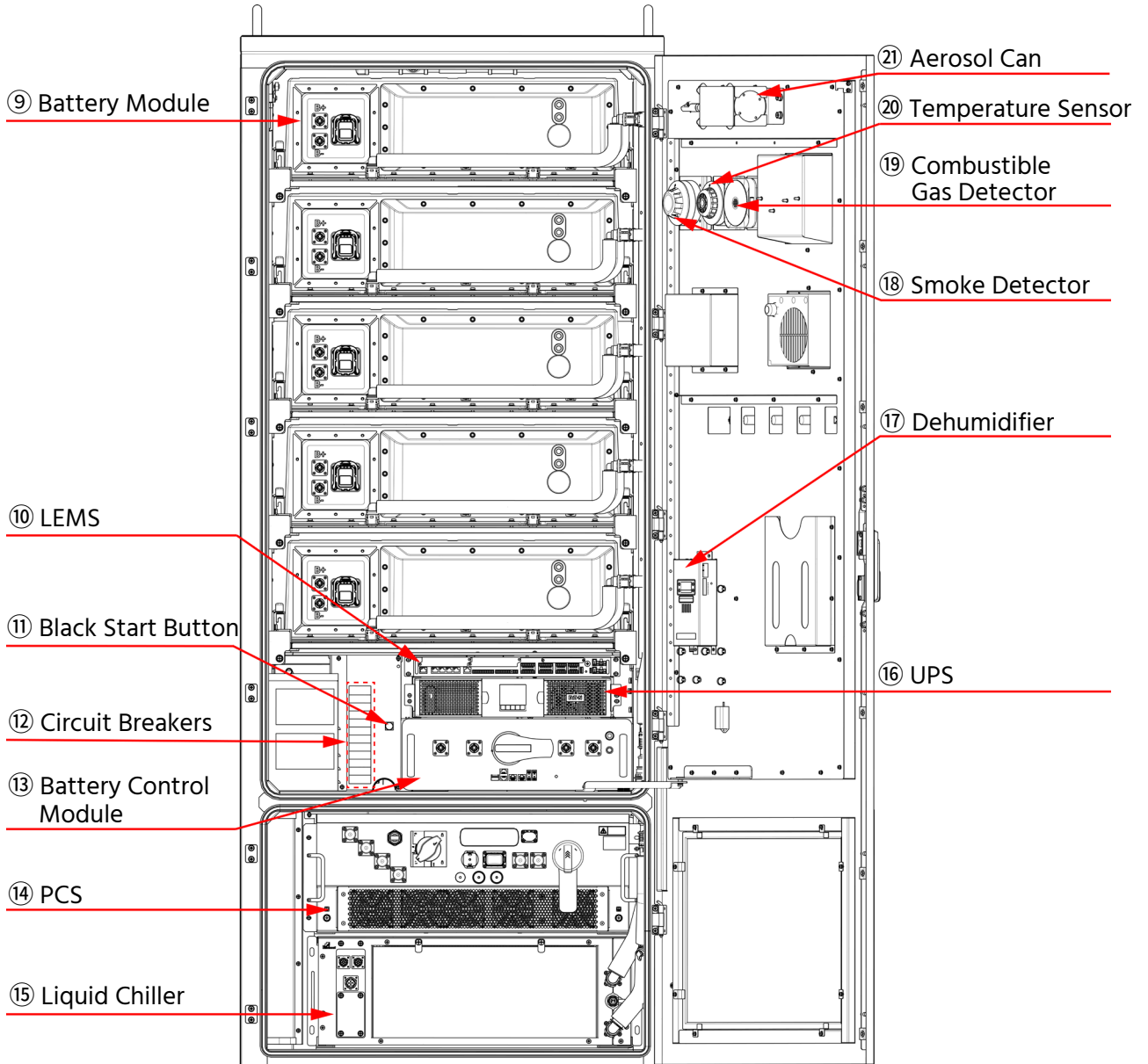

Figure 2: Front View (door open)

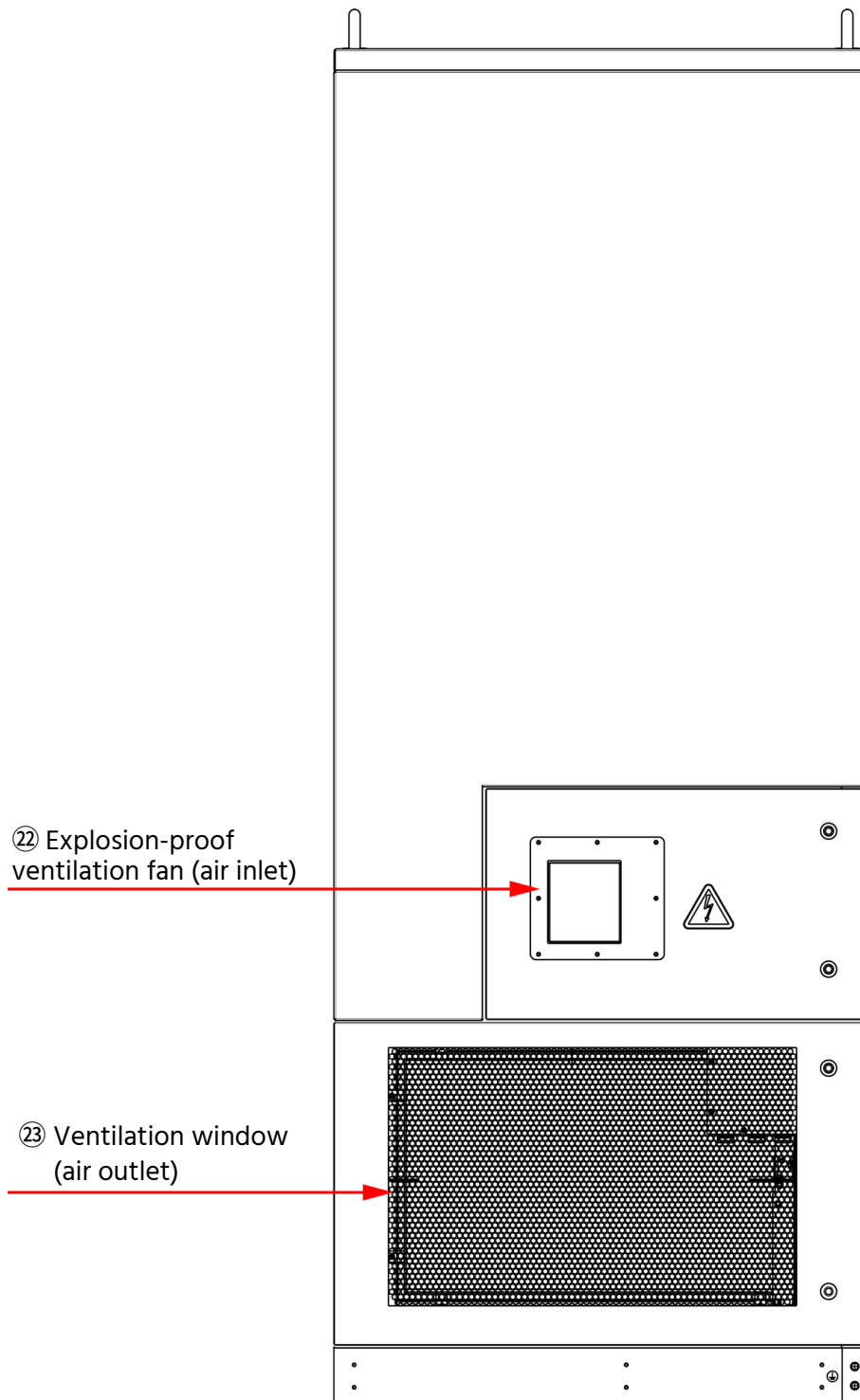

Figure 3: Rear View (door closed)

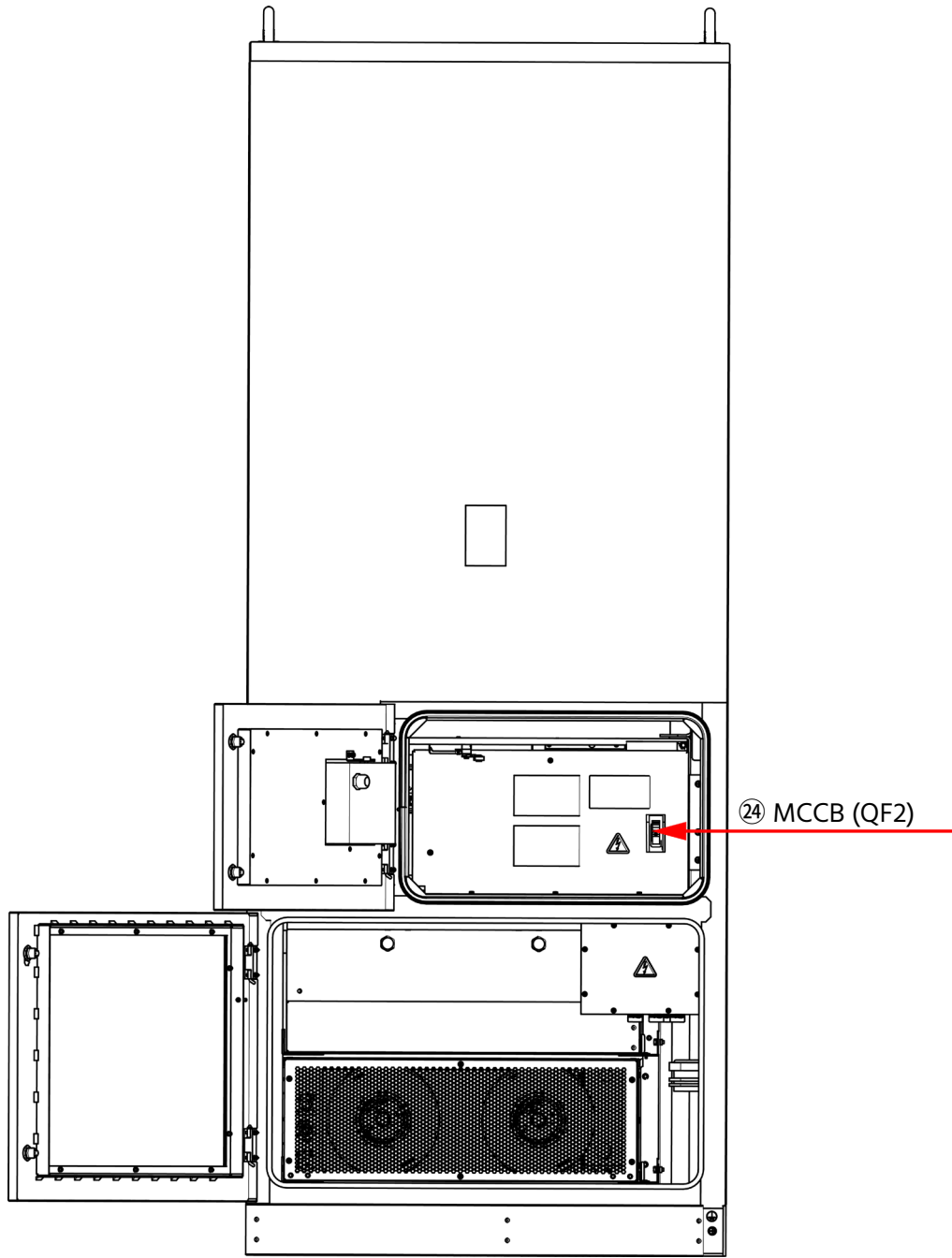

Figure 4: Rear View (door open)

3.5.1 Outdoor Cabinet

Outdoor Cabinet Parameters

Item	Parameters
Dimensions (mm)	950 ± 5 (W) x 2480 ± 5 (H) x 1300 ± 5 (D)
Color	Outdoor Orange Texture RAL9003
IP Rating	IP55
Plate Material	Cabinet body: SGCC, Bottom Base: Q235NH
Corrosion Resistance Grade	C3H
Maintenance	Front and back doors available
Safety Precautions	Outdoor lock

3.5.2 Battery String

The system has one battery string, including one control Module (BMS) and five battery modules.

3.5.2.1 Specifications of the Battery String

Battery String	PowerCube-M7A
Battery Module Model	HM7A200L
Control Module (BMS) Model	OPS10M7A200E
Humidity (%)	5 – 95 (without condensing)
Round-trip efficiency (% , @ 0.5 C)	95%
Depth of Discharge (DOD) (%)	95%
Battery Module Quantity (pcs)	5
Standard Charge/ Discharge Current (A)	150
Maximum Continuous Charge/ Discharge Current (Amps)	196
Peak Current (Amps)	250@15 seconds
Maximum Short Circuit Current (Amps)	14 kA 5 milliseconds
System Rated Capacity (Ah)	314
Total Storage Energy (kWh)	261.2
System Rated Voltage (VDC)	832
Upper limit Charge Voltage (VDC)	936
End-of-discharge Voltage (V)	702

3.5.2.2 Battery Module



Battery Module Specifications

Specifications	HM7A200L
Cell Technology	Li-ion (LFP)
Battery Module Capacity (kWh)	52.25
Battery Module Voltage (VDC)	166.4
Battery Module Capacity (AH)	314
Dimension (W*D*H, mm)	790 (W) ×1145 (D) ×245 (H)
Protection Class	IP65
Weight (kg)	336 ± 5
Charge Temperature (°C)	2~55
Discharge Temperature (°C)	-28~58
Storage Temperature(°C)	-30~60
Transportation Certificate	UN38.3

Battery Module Interface

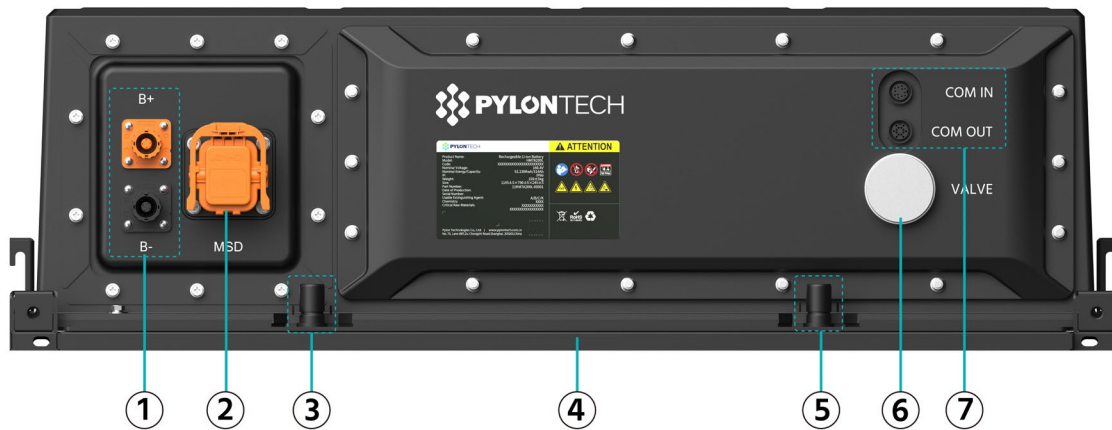

Item	Description	Item	Description
①	Power Terminal B+/B-	⑤	Liquid Outlet Port Connector
②	MSD (Manual service disconnect)	⑥	Pressure Relief Port
③	Liquid Inlet Port Connector	⑦	Communication Port (COM IN/ COM/ OUT)
④	Liquid Cooling Plate		

① Power Terminal B+/B-

Positive (B+) and negative (B-) battery DC input terminals for connecting the batteries in serial.

② MSD

Manual service disconnect for disconnecting the main circuit for maintenance.

③ Liquid Inlet Port Connector

Connects the liquid cooling pipe for coolant in.

④ Liquid Cooling Plate

Regulates battery temperatures by the coolant flowing through the internal channels to ensure optimal battery performance, longevity and safety.

⑤ Liquid Outlet Port Connector

Connects the liquid cooling pipe for coolant out.

⑥ Pressure Relief Valve

Prevents explosions caused by thermal runaway and automatically vents the internal pressure of the battery module in the event of a fire.

⑦ Communication Port (COM IN/ COM/ OUT)

Communication ports (CAN communication), between multiple serial battery modules and control module.

3.5.2.3 Control Module

The appearance and the specifications of the control module are shown as follows.



Specifications	OPS10M7A200E
AC Supply for BMS	230VAC/50Hz/1.3A
System Operation Voltage (VDC)	0~1000
Dimension (mm)	460 (W) × 758 (D) × 160 (H)
Communication	RS485\CAN\LAN
Protection Class	IP20
Weight(kg)	21.25
Operation Life (Years)	15+

Control Module Front Interface

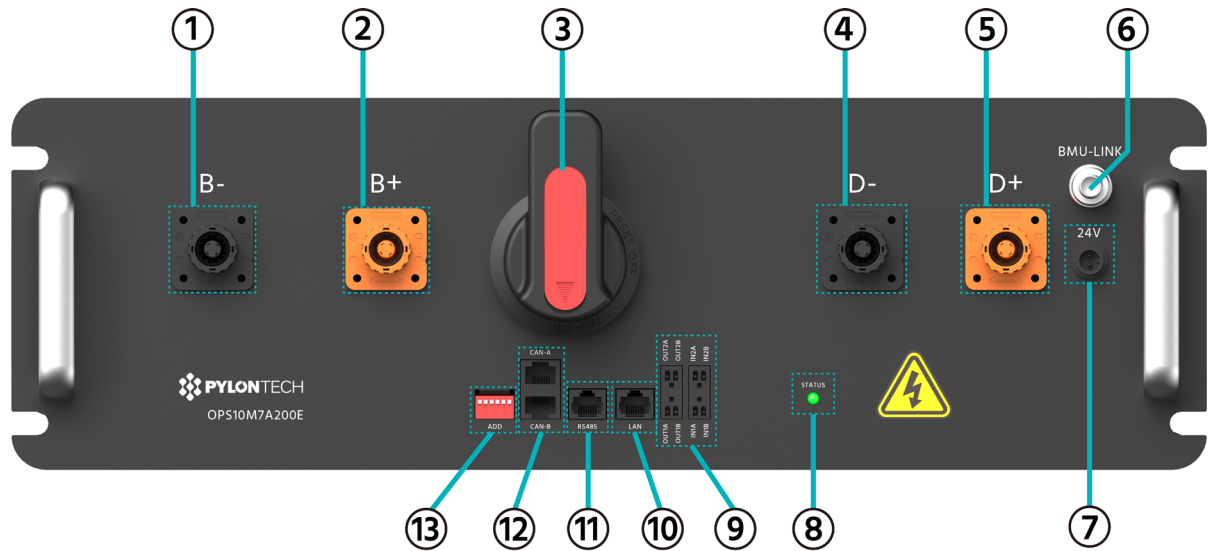

Item	Description	Item	Description
①	Power Terminal B-	⑧	Status LED
②	Power Terminal B+	⑨	Dry Contact
③	Circuit Breaker	⑩	LAN Port
④	External Power Terminal D-	⑪	RS485 Port
⑤	External Power Terminal D+	⑫	CAN-A, CAN-B Ports
⑥	BMU-LINK	⑬	ADD Switch
⑦	24VDC IN		

① Power Terminal B-

The battery 's DC connection for the negative pole.

② Power Terminal B+

The battery 's DC connection for the positive pole.

③ Circuit Breaker

On/Off switch for the control module, and carries out shunt tripping function when system is overcurrent or short circuit.

④ Power Terminal D-

DC connection for the battery string to the negative pole of PCS.

⑤ Power Terminal D+

DC connection for the battery string to the positive pole of PCS.

⑥ BMU-LINK

Communication port to connect the battery module.

⑦ 24VDC IN

Connects to 24VDC external power for supplying power to the control module.

⑧ STATUS (LED)

Indicates the status of the battery string (Normal ●, Abnormal ●).

⑨ Dry Contact

(Dry Contact Terminals): provide 2 input and 4 output dry contact signals.

Dry Contact definitions

In/Out	Function	Open and close state
In1	Reserved	Normal close.
In2	Emergency stop	Normal close, power relay open when signal received.
Out1	Stop charging	Normal close, when suggested charge current is "0", it shall open.
Out2	Stop discharging	Normal close, when suggested discharge current is "0", it shall open.
Out3	Error	Normal close, when system error activated, it shall open.
Out4	Current limit	Normal close, when current limit $\leq 5A$ activated, it shall open.

⑩ LAN Port

RJ45 port, follows Modbus protocol, used for communication between MBMS, switch or upper controller.

⑪ RS485 Port

Console Communication Terminal: (RJ45 port), for manufacturer or professional engineer to debug or service.

⑫ CAN A, CAN B Ports

CAN Communication Terminal: follows CAN protocol, for communication between the battery system and the PCS.

CAN A connects to another BMS (Battery control module).

CAN B connects to PCS.

⑬ ADD Switch

6-bit dial switches to manually distribute the communication addresses of the battery system.

Lower position is OFF, means "0". Upper position is ON, means "1". 1st bit to 5th bit are for address, and the 6th bit dial switch supports a 120Ω resistance.

3.5.3 LEMS

The outdoor cabinet adopts a local energy management system device LEMS 1000 for communication. It can communicate upwards with the devices as upper controller. It can also communicate downwards with the devices as battery control module, PCS, fire suppression control panel, power meter, UPS, thermal management device, sensors, etc.



Item	Parameter
Operating voltage range (VDC)	9~36
Communication interface	LAN/CAN/RS485/RS232/USB
System Consumption (W)	12
Dimensions (mm)	482.6(L) x 246.5 (D) x 44 (H)
Protection degree	IP20
Pollution degree	PD2
Protection degree	IP20
Weight (kg)	4.0
Working temperature (°C)	-40~85
Storage temperature (°C)	-40~85
LAN (maximum 10 Sockets)	Speed:100/1000Mbps
CAN (maximum 3 groups)	Baud rate: 500K; terminal resistance: 0/120Ω
RS485 (maximum 6 groups)	Baud rate:9600/115200
RS232(maximum 2 groups)	Baud rate:115200
DI (maximum 16 connects)	Dry Digital Input
DO (maximum 8 connects)	Passive Digital Output
USB	USB 2.0
Operation Life (year)	15



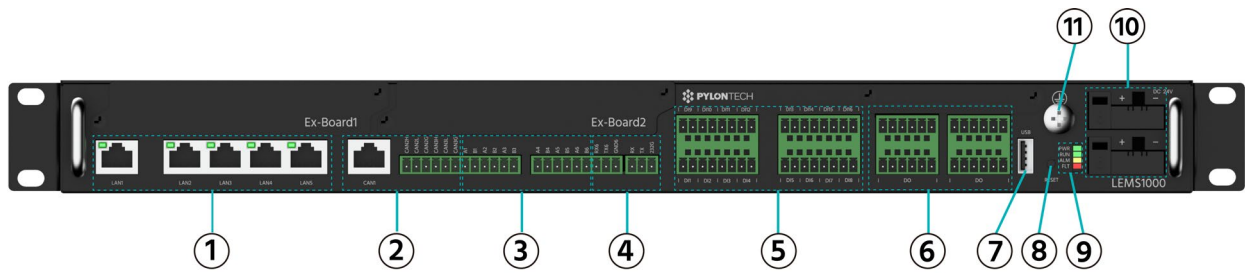

3.5.3.1 Interface Panel of the MBMS



No.	Port	Silk-screen	Description and Function	
1	LAN	LAN1	An Ethernet Port (100Mbps) with default IP:192.168.10.100	Used for SCADA, EMS, Cloud Platform and etc. They are backup for each other, and support IEC61850, IEC60870-5-104, and Modbus/TCP protocols.
		LAN2	An Ethernet Port (1Gbps) with default IP:192.168.11.100	
		LAN3	LAN3 and all batteries' main control boards (CMUs) are connected to the ethernet switch so they can communicate with each other by Pylon IBC Protocol.	LAN3/4/5 are switched from the chip's original 1Gbps LAN port with default IP:162.172.1.100, 192.168.3.100, and 192.168.0.100.
		LAN4	Used to connect to PCS through Modbus/TCP protocol, and the slave LEMS1000s.	
		LAN5	Used to connect to the touch screen or PCs with BatteryView Pro installed.	
2	CAN	CAN1	a RJ45 Port, pin2 is CAN1G, pin4 is CAN1H, pin5 is CAN1L.	All these three CAN ports can be connected through CAN ports to devices e.g. PCs.
		CAN2H/ CAN2L/ CAN2G (CAN2)	CAN Port	
		CAN3H/ CAN3L/ CAN3G (CAN3)	CAN Port	

No.	Port	Silk-screen	Description and Function
3	RS485	A1B2~A6B6	All these six RS485 ports can be connected through RS485 ports to devices, e.g. air-conditions, energy meters, humidity-temperature sensors, liquid chiller, H2/CO concentration sensors, PCSs, dehumidifiers, etc.
4	RS232	RX6/TX6/GND6 RX/TX/232G	Two debug ports.
5	DI	DI1~16	Dry Contact, 16 Digital Inputs. Passive signal or active signal not higher than 5V. They can be used to monitor the signals such as fire-alarm, door open, UPS fault, PCS fault and etc. And every signal can be configured to any DI arbitrarily from DI1 to DI16. The default state can be configured also. Use the signals according to the specific system, referring to <i>section 2.2</i> for details of the DI signals.
6	DO	DO1~8	Dry Contact, 8 Isolated passive Digital Outputs, specification is DC 30V/2A, AC 240V/0.25A. They can be used to control the signals such as main shunt trip, LEDs, load relay, on-off grid relay and etc. And every signal can be configured to any DO arbitrarily from DO1 to DO8. Each DO port has three pins for NC, COM, NO, and can be used flexibly. Use the signals according to the specific system, referring to <i>section 2.3</i> for details of the DO signals.
7	USB	USB	USB2.0 port for device upgrade or data download using a U-disk.
8	Reset Switch Button	RESET	Press this button restart the system.
9	LED Indicators	PWR/RUN/ALM /FLT	See <i>Section 2.4</i> for detailed instructions.
10	9~36VDC input	DC 24V + -	Power supply for the device, external power supply of 9~36VDC. There are two power ports for backup.
11	Grounding Bolt		Grounding Protection

3.5.3.2 LED Indicators Instructions

LED Indicator	Silk-screen	Indication	Details
	PWR	Power LED	<p>Green. LED indicator on indicates the device itself is Powered on.</p> <ul style="list-style-type: none"> ● When the device is powered on, it will flash once per two seconds (0.5Hz). ● When the device is being upgraded or data-downloading, it will flash twice per second (2Hz).
	RUN	Run LED	<p>Green. LED indicator on indicates the system is Running.</p> <ul style="list-style-type: none"> ● When the device is running normally, it will be constant on. <p>NOTE: DO NOT perform maintenance work when the system is running.</p>
	ALM	Alarm LED	<p>Yellow. LED indicator on indicates the system is in Alarm status.</p> <ul style="list-style-type: none"> ● When the LED flashes once per two seconds (0.5Hz), it indicates a minor alarm. ● When the LED is constant on, it indicates a major alarm.
	FLT	Fault LED	<p>Red. LED indicator on indicates the device is in Fault status.</p> <ul style="list-style-type: none"> ● When the system has a critical issue, it will be constant on. And most power supply will be shutdown. <p>NOTE: If this happens, the device needs check or repair prior to further work.</p>

3.5.4 PCS (Metis-130-E)

The directional PCS realizes the charge and discharge control of the energy storage battery. It is an important part of the smart grid, which can regulate power resources and ensure the normal operation of the grid. On one hand, the PCS can invert the direct current of the energy storage battery into alternating current to supply power to the load or input into the grid; on the other, the PCS can rectify the alternating current of the grid into direct current to charge the energy storage battery.



3.5.4.1 Interface Panel of the PCS

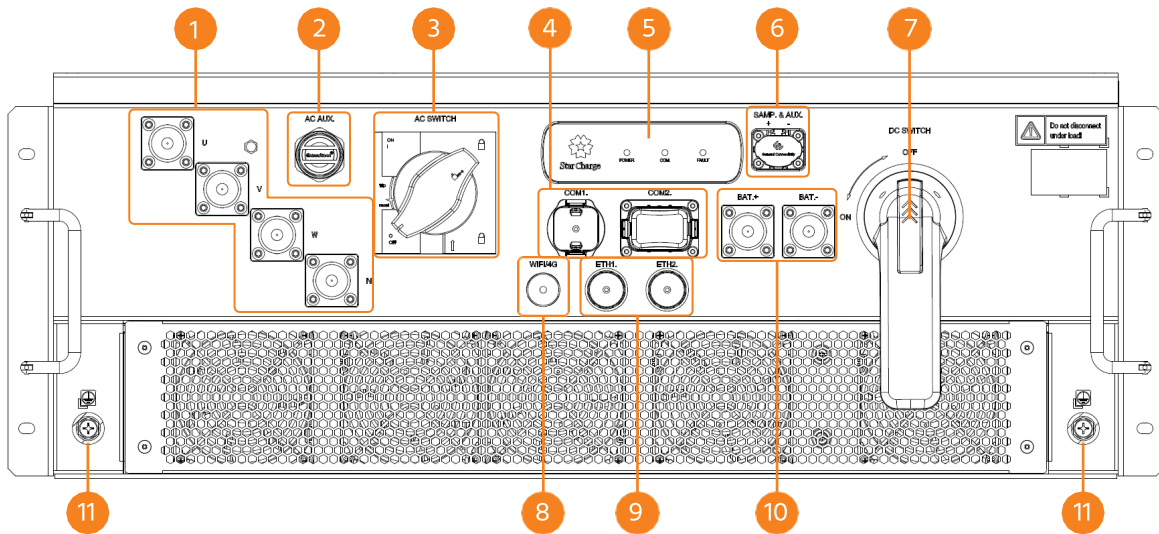

No.	Item	Description
1	Grid interface AC (U/V/W/N)	AC input connection
2	AC AUX. (AC auxiliary power supply interface)	Output interface for supplying AC power to loads within the energy storage cabinet
3	AC Switch (AC molded case circuit breaker)	Switch for connecting to the grid
4	COM1. COM2. (Communication and dry contact interface)	External communication and dry contact
5	Display Panel	Indicates the machine status
6	SAMP&AUX. (Voltage sampling and DC auxiliary power supply)	Battery voltage sampling and DC auxiliary power supply output wiring

7	DC Isolator Switch	Connection switch with battery
8	Wi-Fi/4G (interface)	Communication dongle interface
9	ETH1. ETH2. (Ethernet Interface, currently not enabled)	Ethernet communication wiring (currently not enabled)
10	BAT+. BAT-. (Battery interface)	DC input connection
11	Protective earthing point	Connection point for protective earthing

3.5.4.2 Display Panel of the PCS

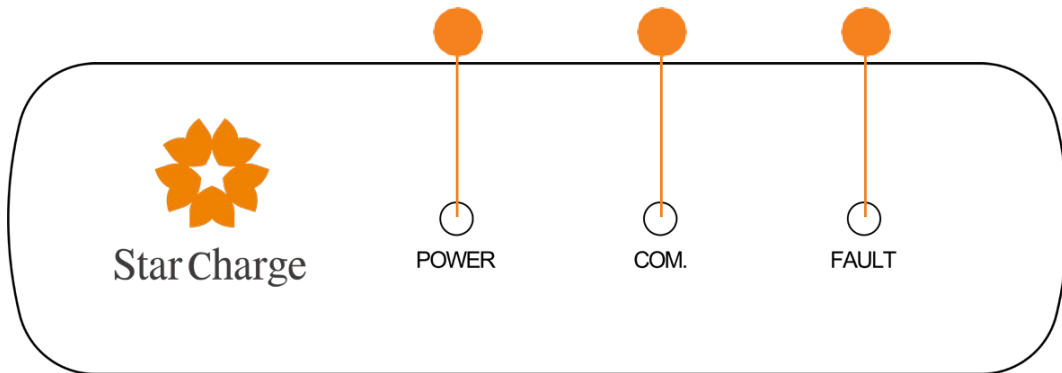

Description of LED indicators on the LED panel

No.	Silk Screen	Display Color	Description
1	POWER	Green	Running Status Indicator
2	COM.	Green	Communication Indicator
3	FAULT	Red	Fault alarm Indicator

Status description of the indicator board

LED Indicator	Color	State	Meaning	Explanation
①POWER	Green	On (Solid)	On Grid	The PCS is in on-grid operation mode.
		Blink (1s on, 1s off)	Off Grid	The PCS is in off-grid operation mode.
		Fast Blink (0.2s on, 0.2s off)	Self-check or pre-synchronization	The PCS is in self-check or grid synchronization.
		Slow Blink (1s on, 4s off)	Power supplied but not running	The PCS is not running, but auxiliary power is supplied.
		Medium Slow Blink (1s on, 2s off)	Standby	The PCS is in standby operation mode.
		Off (Solid)	No power or fault	The device has a fault or no auxiliary power is supplied.

②COM.	Green	Slow Blink (1s on, 4s off)	CAN Communication	The device receives CAN data.
		Medium Slow Blink (1s on, 2s off)	ECB Communication	The device receives ECB data.
		Blink (1s on, 1s off)	IOT Communication	The device receives IOT data.
		Fast Blink (0.2s on, 0.2s off)	Firmware Upgrade	The PCS is undergoing a firmware upgrade.
		Off (Solid)	No Data Interaction	The PCS does not receive communication data.
③FAULT	Red	Fast Blink (0.2s on, 0.2s off)	Earth fault	The PCS has earth fault.
		On (Solid)	ARC fault	The PCS has ARC fault.
		Blink (1s on, 1s off)	Significant fault	The PCS has significant fault.
		Slow Blink (1s on, 4s off)	Minor fault	The PCS has minor fault.
		Off (Solid)	No fault	The PCS has no fault.

3.5.5 Liquid Chiller (EMW50HFNC1A)

The outdoor cabinet is equipped with a 5kW liquid chiller to control the temperature and of the battery compartment.

The energy storage battery system inside the cabinet is the main heat source. And the liquid chiller's parameters are selected based on the battery system's total heat generation to meet the requirements in the target environment.

Product Specifications

Product Model	EMW50HFNC1A
Dimensions, Weight & Mounting Method	
Dimensions (mm)	700 (W) ×900 (D) × 245 (H)
Weight (kg)without coolant)	75
Installation Method	Horizontal Embedded
Inlet and Outlet Connection	DN20 Quick Connector
Environmental Protection & Performance	
Working Temperature Range (°C)	-30~+55
Storage Temperature Range (°C)	-40~+70
Working altitude (m)	≤3000m (The refrigerating capacity is derated when the altitude is above 1000m, and the refrigerating capacity will be derated by 5% for every 1000m increase.)
Noise Level (@1 meter, dB(A))	75
Corrosion-proof Grade	C3M
IP Protection Level (for outdoor side)	IPX5
Appearance	RAL7035 Outdoor Orange Stripe
Refrigerant	R134a
Coolant	50% glycol solution
Design Life (year)	10
Air Outlet Method	Rear Air Outlet
RoHS Compliant	Yes
Cooling/Heating Capacity	
Cooling Capacity @ W18/L35 (kW)	5.0
Heating Capacity @Tu=10°C (kW)	2.0
Outlet Coolant Temperature (°C)	18

Parameter Determination	
Outlet Temperature Setting Range (°C)	10~35 (Heating Point≤ Cooling Point)
Default Cooling Set Point (°C)	18
Default Heating Set Point (°C)	15
Communication Protocol	RS485/CAN
Recycled Flow	
Rated Circulating Flow (L/Min)	46.5@60kpa
Power Consumption	
Cooling Input Consumption@ W18/L35 (kW)	2.50
Heating Input Consumption@ Tu=10°C (kW)	2.35
Self-cycling Mode (Single pump operation) Consumption (kw)	0.25
Maximum Power Consumption (kW)	3.60
Power Supply	
Rated Operating Voltage (V, HZ)	220~240V 50/60Hz
Power Supply Range (V, HZ)	220±15%, 50/60±3Hz
Max. Operating Current (A)	19.2

Product Appearance

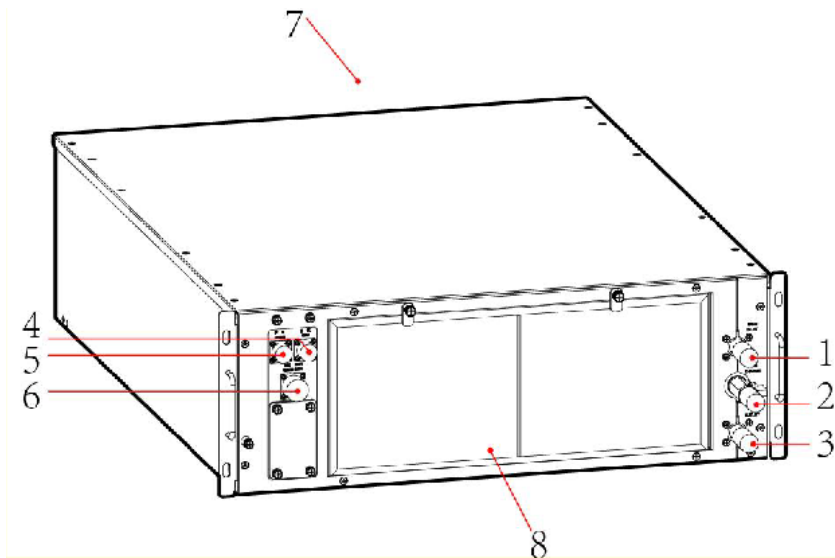
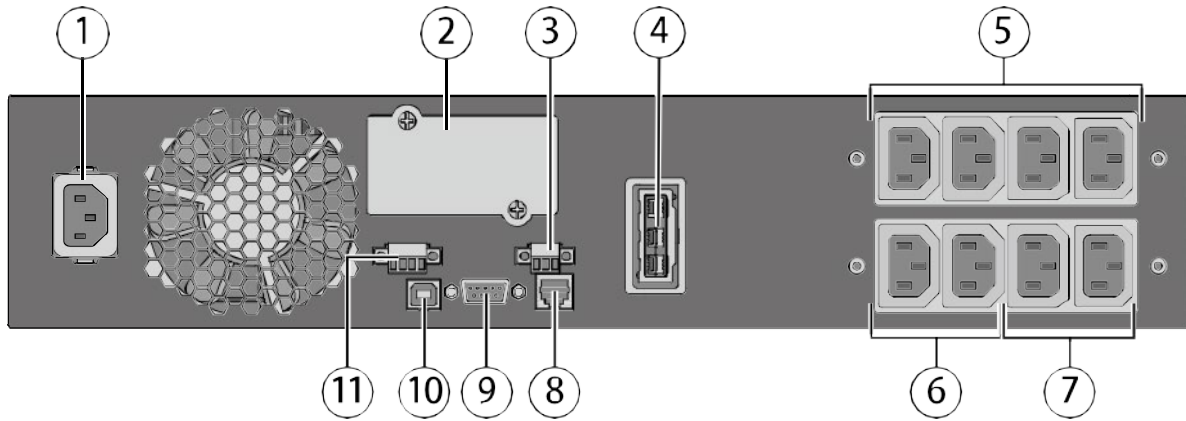

Figure	Description	Figure	Description
1	Coolant inlet	5	Debug interface
2	Coolant filling & drain port	6	Power interface
3	Coolant outlet	7	Air outlet
4	COM interface	8	Air inlet

3.5.6 UPS (9PX1000IRT2U)

The cabinet is equipped with a set of UPS (uninterruptible power supply) to provide backup power for BMS, LEMS, Gas detector, temperature sensor, smoke sensor, etc. in the integrated cabinet.

3.5.6.1 Rear Panel of the UPS



NO.	Description	NO.	Description
①	Socket for connection to AC power source	⑦	Group 1: programmable outlets for connection of equipment
②	Slot for optional communication card	⑧	Connector for automatic recognition of an additional battery module
③	Relay output contact	⑨	RS232 communication port
④	Connector for additional battery module	⑩	USB communication port
⑤	Primary group: outlets for connection of critical equipment	⑪	Connector for ROO (Remote On/Off) control and RPO (Remote Power Off)
⑥	Group 2: programmable outlets for connection of equipment		

3.5.6.2 Control Panel of the UPS

The UPS has a five-button graphical LCD. It provides useful information about the UPS itself, load status, events, measurements and settings.

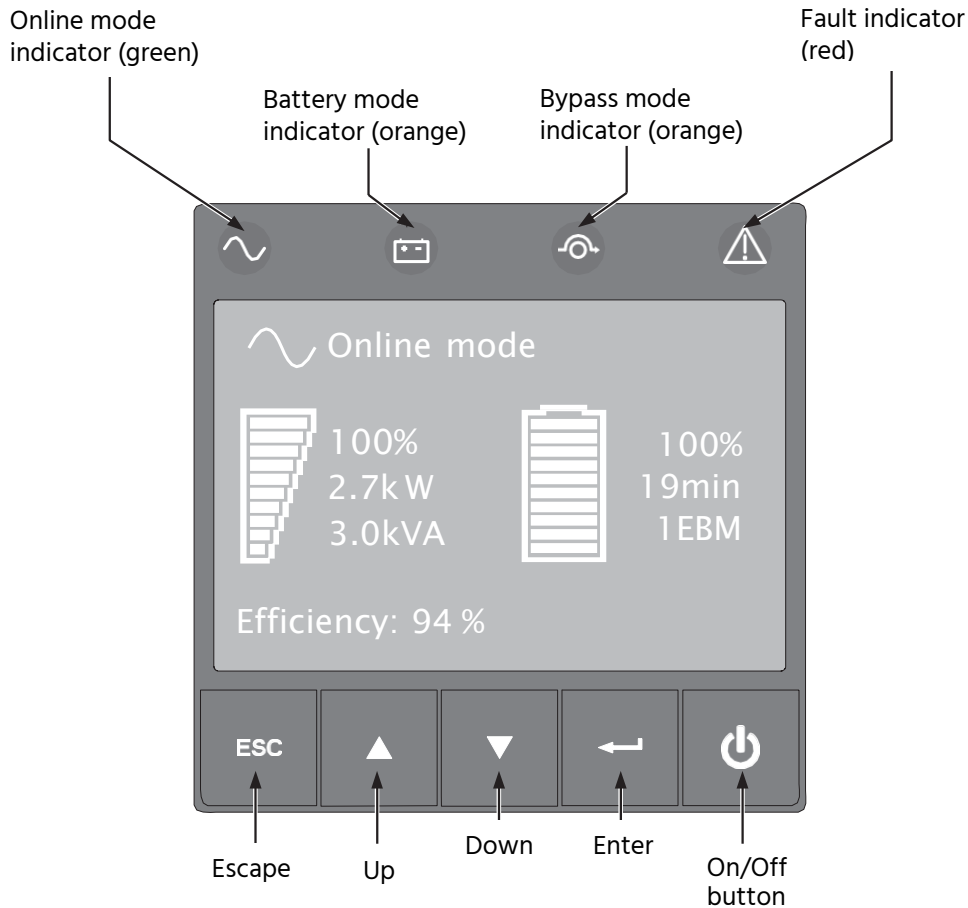

The following table shows the indicator status and description:

Indicator	Status	Description
Green	On	The UPS is operating normally on Online or on High Efficiency mode.
Orange	On	The UPS is on Battery mode.
Orange	On	The UPS is on Bypass mode.
Red	On	The UPS has an active alarm or fault. See trouble-shooting on page 35 for additional information.

NOTE:

- (1) The UPS charges the battery as soon as it is connected to the AC-power source, even if button is not pressed.
- (2) To ensure the UPS can provide adequate backup time, charge the UPS battery for eight hours before it is put into operation.

For more information about the UPS, please refer to the separate UPS manual.

3.5.7 Safety Features

This system is equipped with the safety features, e.g. fire suppression system, smoke detector, temperature sensor, gas detector, explosion-proof ventilation fan (air inlet and air outlet), battery system over temperature protection, etc. When a fire or other emergency occurs or the temperature reaches certain point, aerosols will be released from the fire extinguisher to suppress the fire. At the same time, the fire alarm will sound until the system is powered off.

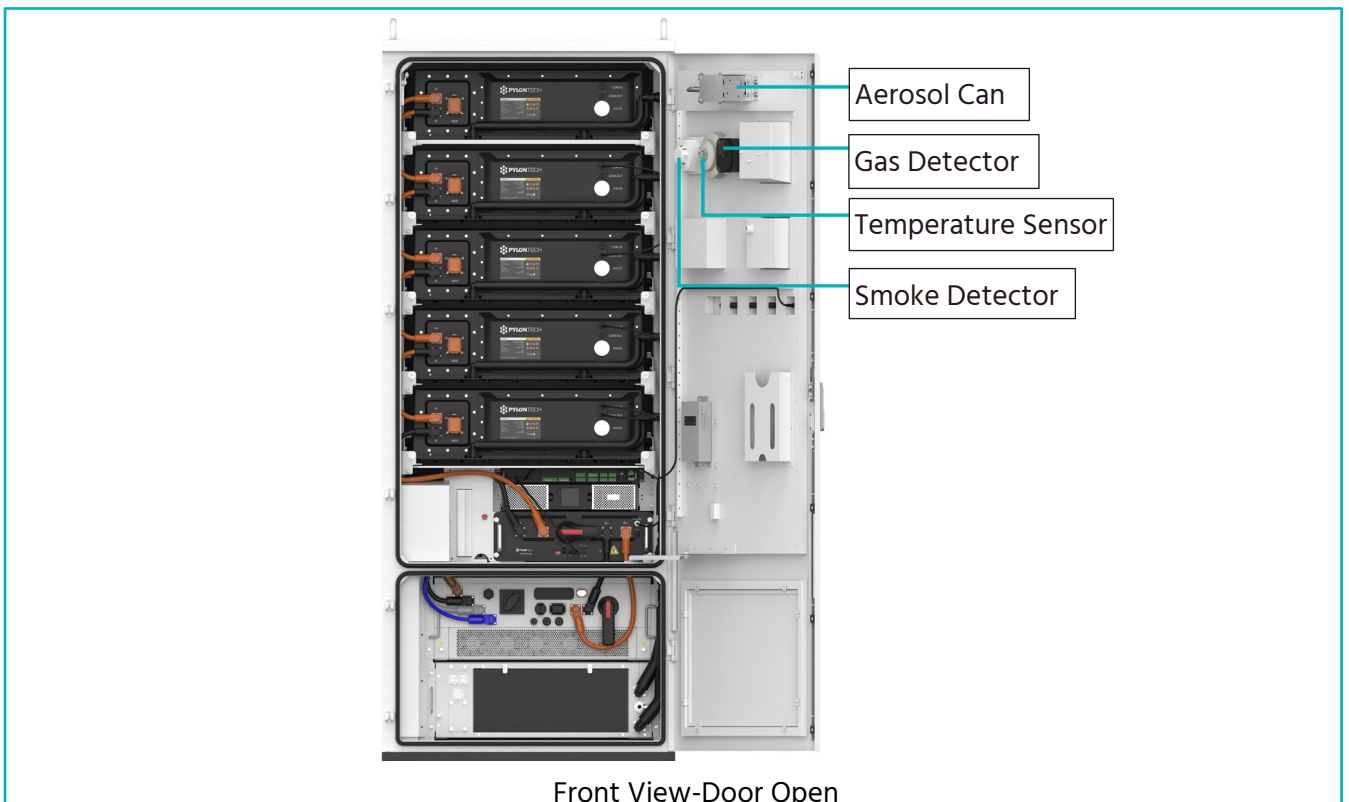
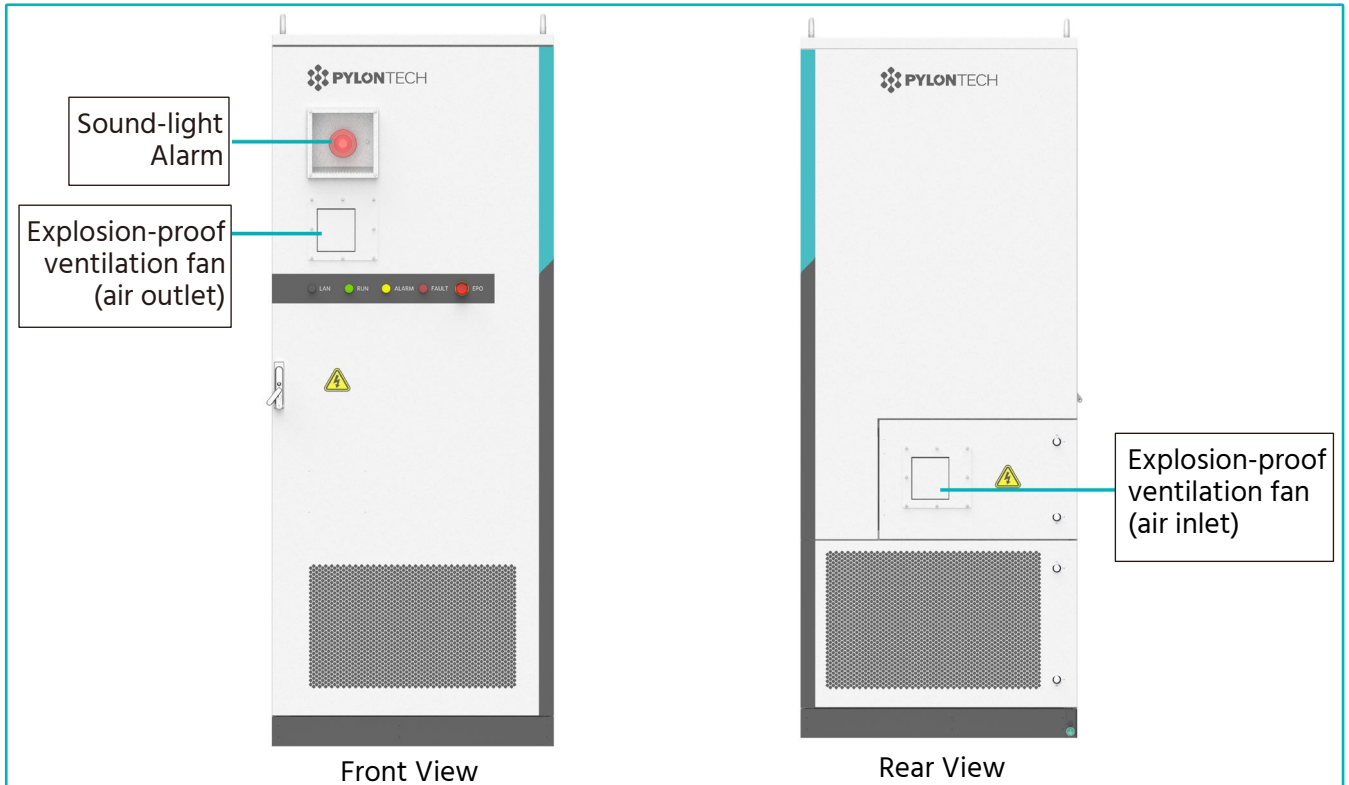

3.5.7.1 Fire Suppression System Introduction

The outdoor battery cabinet is equipped with an aerosol fire extinguishing solution. The fire extinguishing mechanism of aerosol is mainly reflected in two aspects:

- (1) The cooling effect of endothermic decomposition.
- (2) The chemical inhibition of the gas phase and the solid phase plays a synergistic role between each other.

Specifications of Aerosol Can

<p>FP-200S</p> 	Technical Information	
	Product Model	FP-200S
	Activation mechanism	Thermal activation Electrical (minimum 1.5VDC, minimum 0.8A in 3~4 seconds)
	Activator type	Heating element with 2.3 ohm resistance
	Activate line supervision current	Maximum 5 mA
	Wight gross	1840 g
	Mass of FPC Compound	200 g
	Operational discharge time	5~10 seconds
	Discharge outlet	1
	Discharge length	2 meters
	Size	185 mm x 84 mm (including connector housing)
	Self-activation temperature	300 °C
	Fire Class	A, B, C, F

4 Mechanical Installation

4.1 Checking Before the Installation











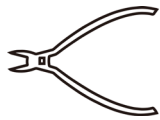
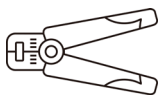

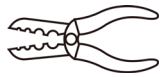

Checking the Outer Packing

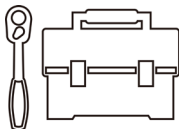
After receiving the product, check the outer packing for damage, such as holes, cracks, deformation and so on. If any damage is found, contact us as soon as possible.

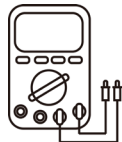
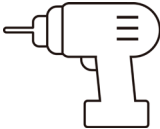
Checking Deliverables

After unpacking the product, check that the deliverables are complete. If any item is missing or damaged, contact us as soon as possible.

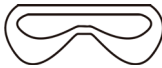
4.2 Preparing Tools and PPE

Tools					
					
Wire Cutter	Crimping Modular Plier	Adjustable Wrench	Wire Stripper	Torque Wrench	Screwdriver
					
Cable Tie	Socket Wrench set	Electric Drill	1000VDC Multimeter	Electric Screwdriver	
PPE (Personal protective equipment)					
					
Insulating Gloves	Anti-arc Flash Suit	Safety Shoes	Ear Protector	Safety Goggles	Anti-static Bracelets

NOTE:

Use properly insulated tools to prevent accidental electric shock or short circuits. If insulated tools are not available, cover the entire exposed metal surfaces with available insulated alternatives, except their tips, with electrical tape.

4.3 Selecting the Installation Sites

4.3.1 Working Environment Requirements

The following requirements must be met for installation:

- Be sure to keep the cabinet away from high salt spray, corrosive environment, away from heat source and flammable and explosive materials.
- The installation environment should be as far away from the living area as possible. If there is a large flow of people in the installation site, it is recommended to install a fence.
- The ambient temperature should be guaranteed between -25-55°C to ensure that the outdoor integrated cabinet can operate normally.

4.3.2 Installation Space Requirements

- The external dimensions of the storage system are 950 mm (W) x 1300 mm (D) x 2480 mm (H). And the installation site must have enough space to place the equipment.

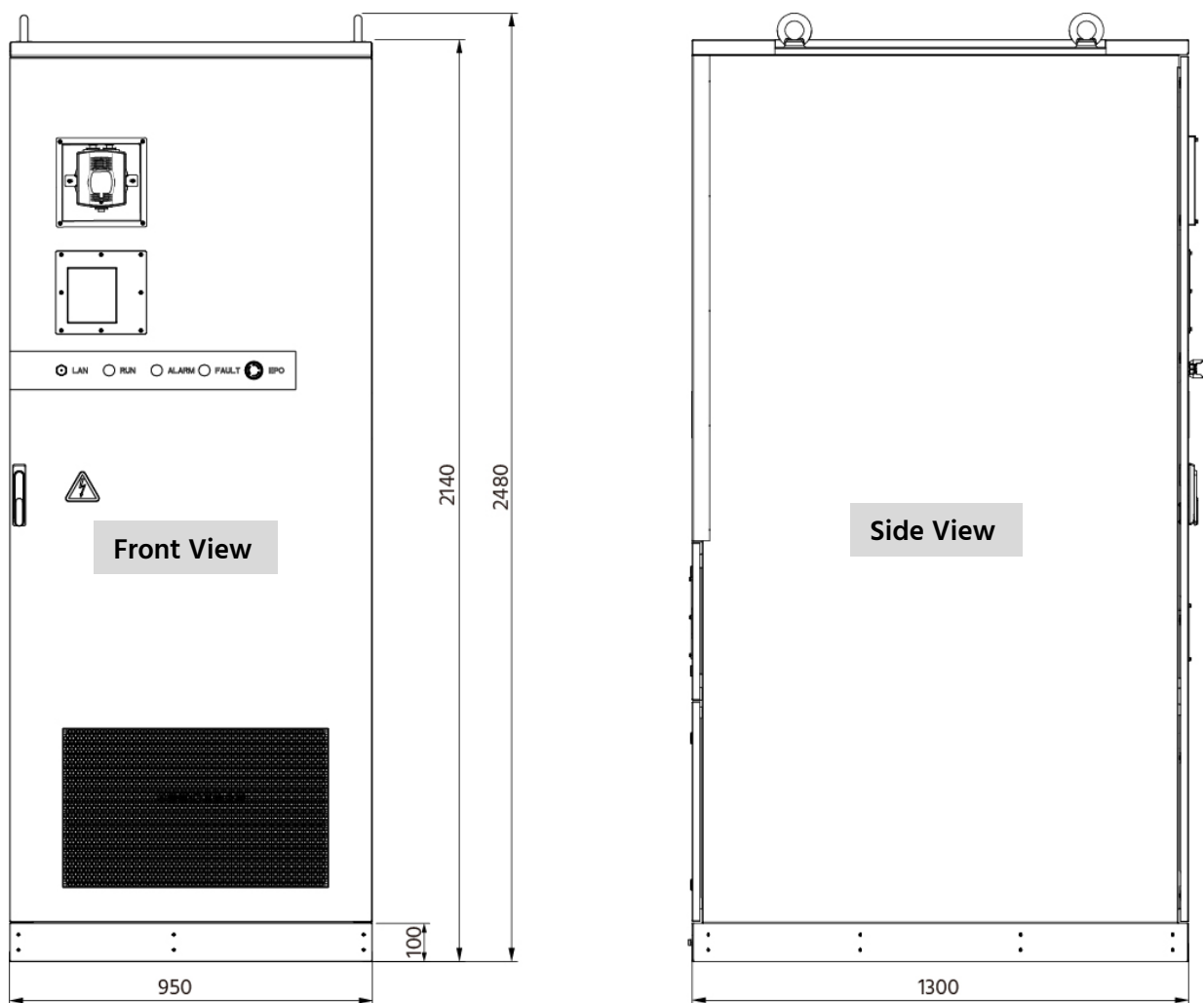

(Unit:mm)

- The installation space for a single cabinet system is shown below (recommended spacing).

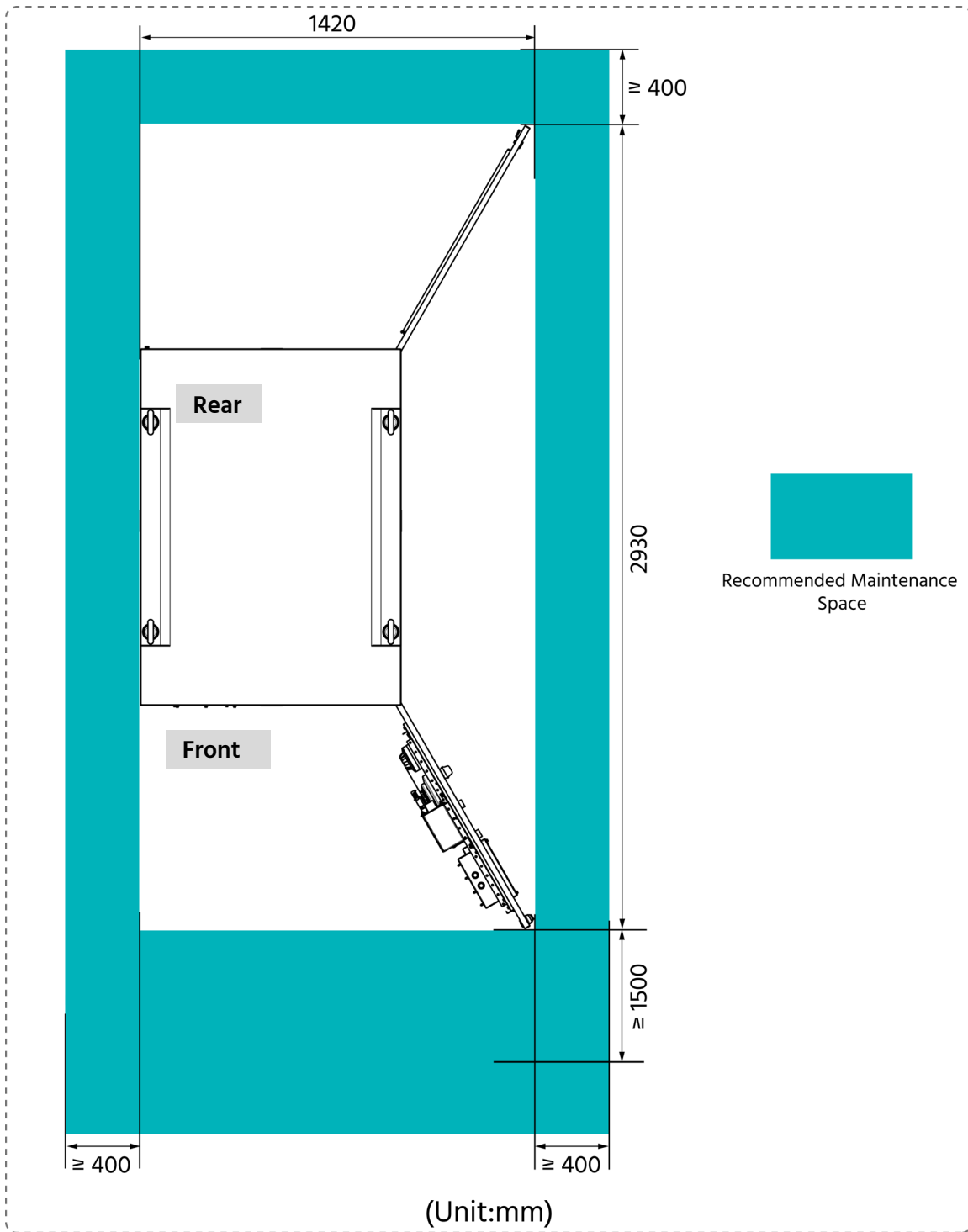

4.3.3 Installation Foundation Requirements

The installation site needs to meet the following requirements:

- The installation foundation should be able to bear the total weight of the whole outdoor cabinet system (about 2900kg).
- The installation foundation should be concrete or channel steel support structure, which should be flat, firm, safe and reliable. The installation foundation must meet the following height requirements, whichever is higher:
 - above the highest water level in the history of the area; or
 - at least 300mm above the level ground

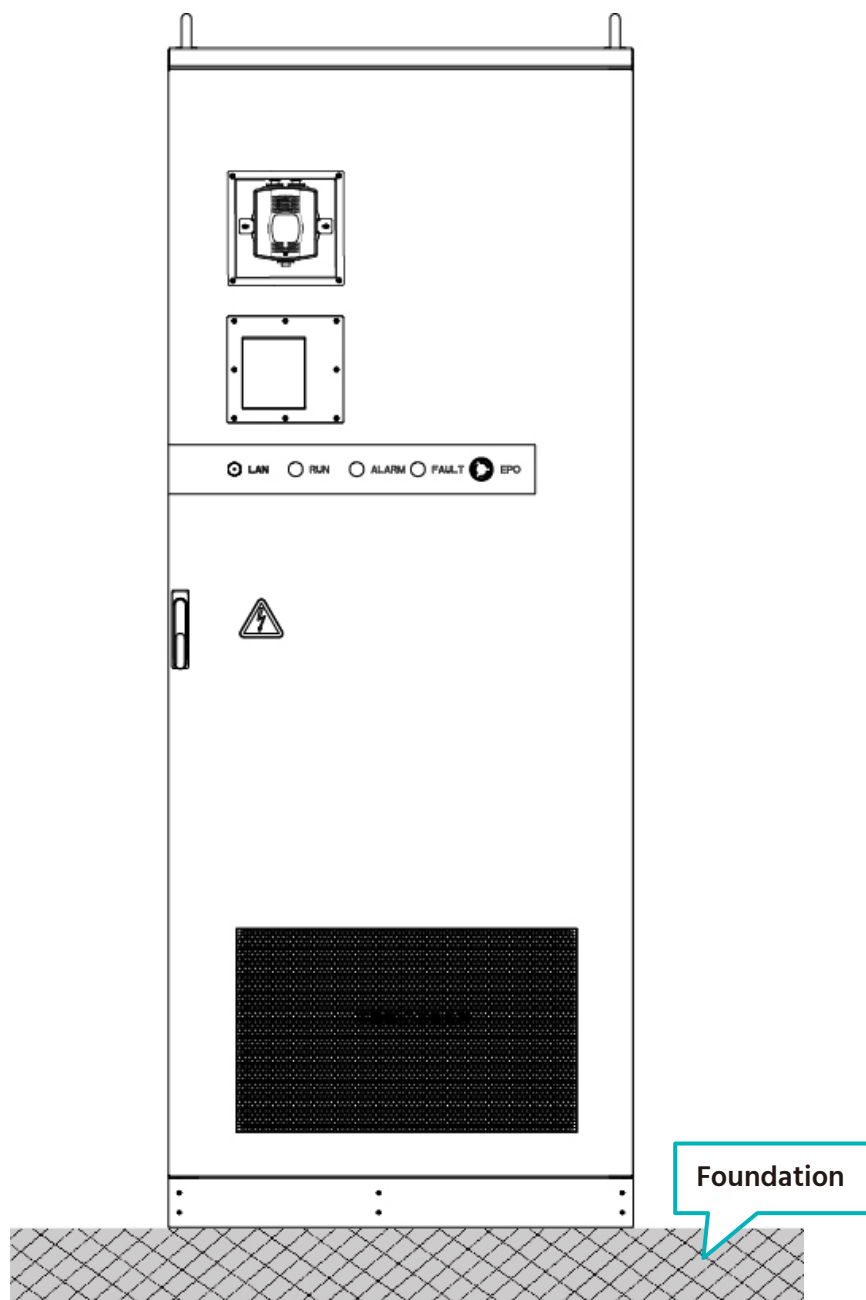

- The cabinet is fixed at the bottom, and holes should be pre-opened on the installation site in accordance with the fixed holes (marked in red) in the base of the cabinet. See the drawing below.

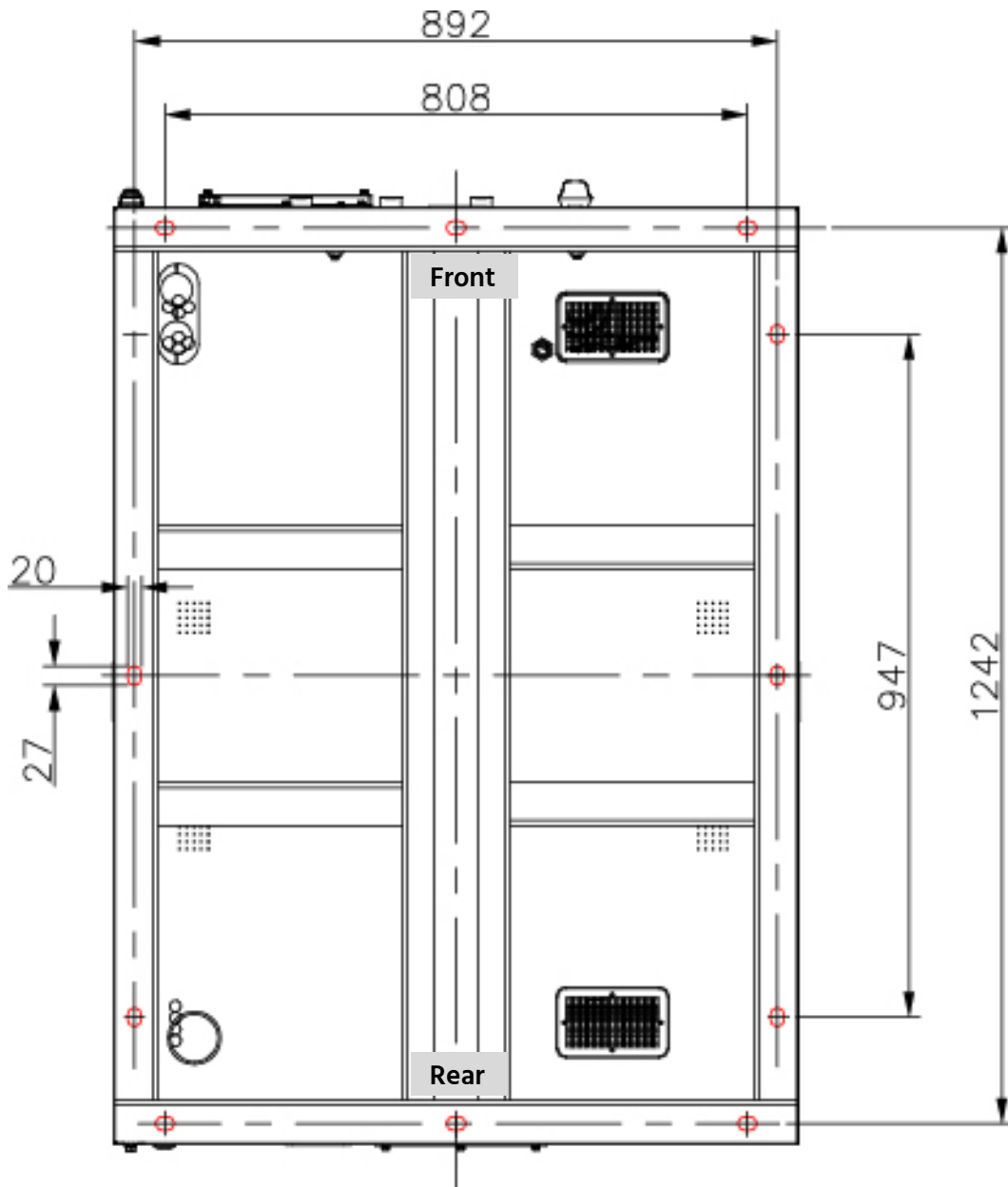

Positioning holes of the cabinet base (Unit: mm)

⚠ WARNING

The inlet and outlet holes in the lower part of the outdoor cabinet need to be sealed with fireproof mud after the cable is connected.
And the entire outdoor cabinet base needs to be sealed with fireproof mud, waterproof and insect-proof.

4.4 Handling of the Cabinet

The outdoor cabinet can be transported by crane or forklift.

DANGER

Pay attention to the falling risk which can cause severe injury or death. Do not stand under a lifted load. Make sure no unauthorized personnel are in the vicinity of a lifted load.

CAUTION

Pay attention to the center of gravity when lifting or forking the cabinet and keep the moving process slow, smooth and balanced.

During the moving process, the equipment should not be tilted at an angle of more than 5° and should not be suddenly lowered or lifted.

Positions of the lifting rings and forklift slots

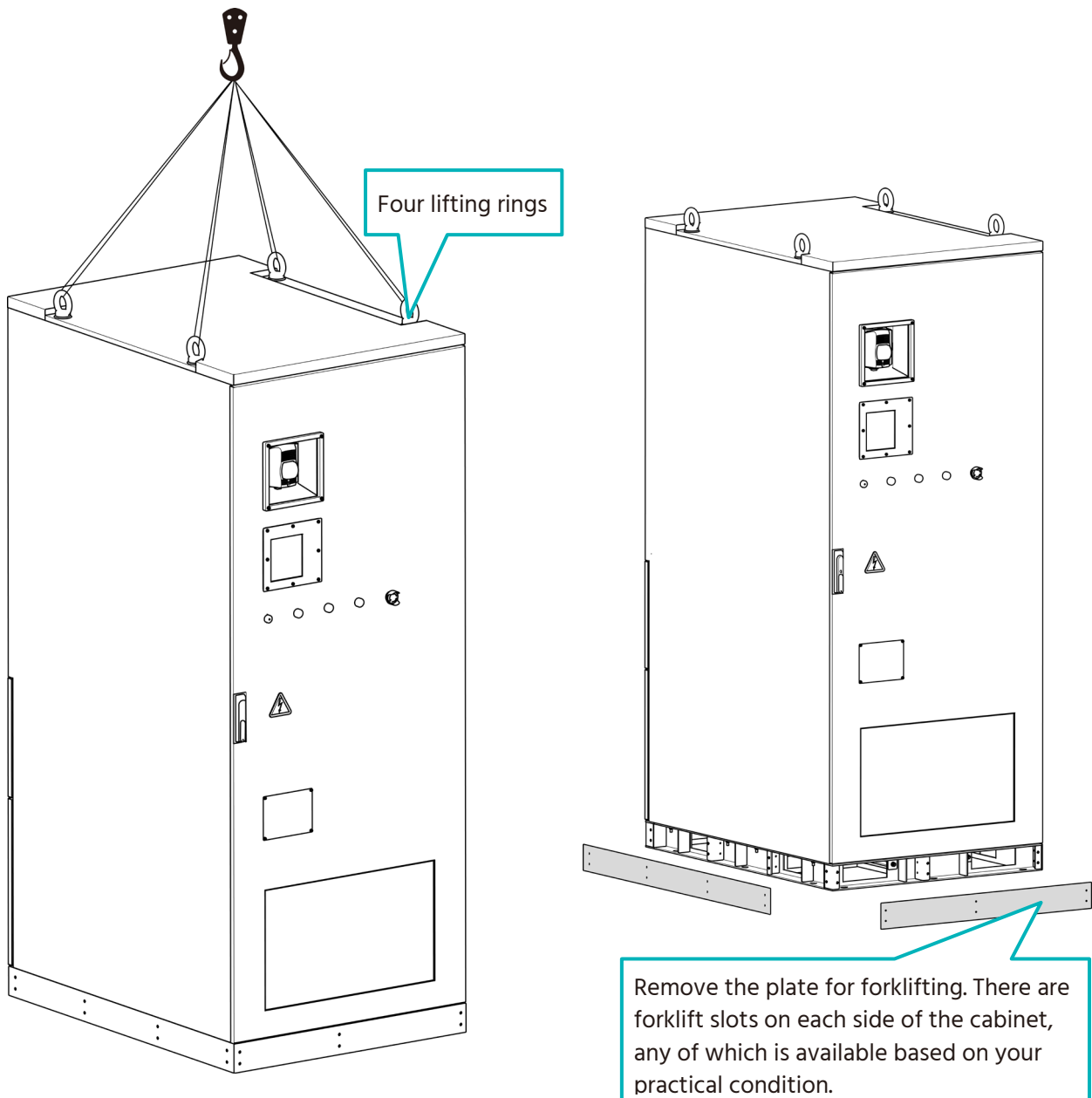

4.5 Mechanical Installation Steps

- 1. Before installation, make sure that the mounting dimensions of the foundation are consistent with the mounting holes of the cabinet bottom base, as shown in the figure below.
- 2. Use a crane or forklift to place the cabinet on the mounting foundation, aligning the 12 mounting holes (marked in red).

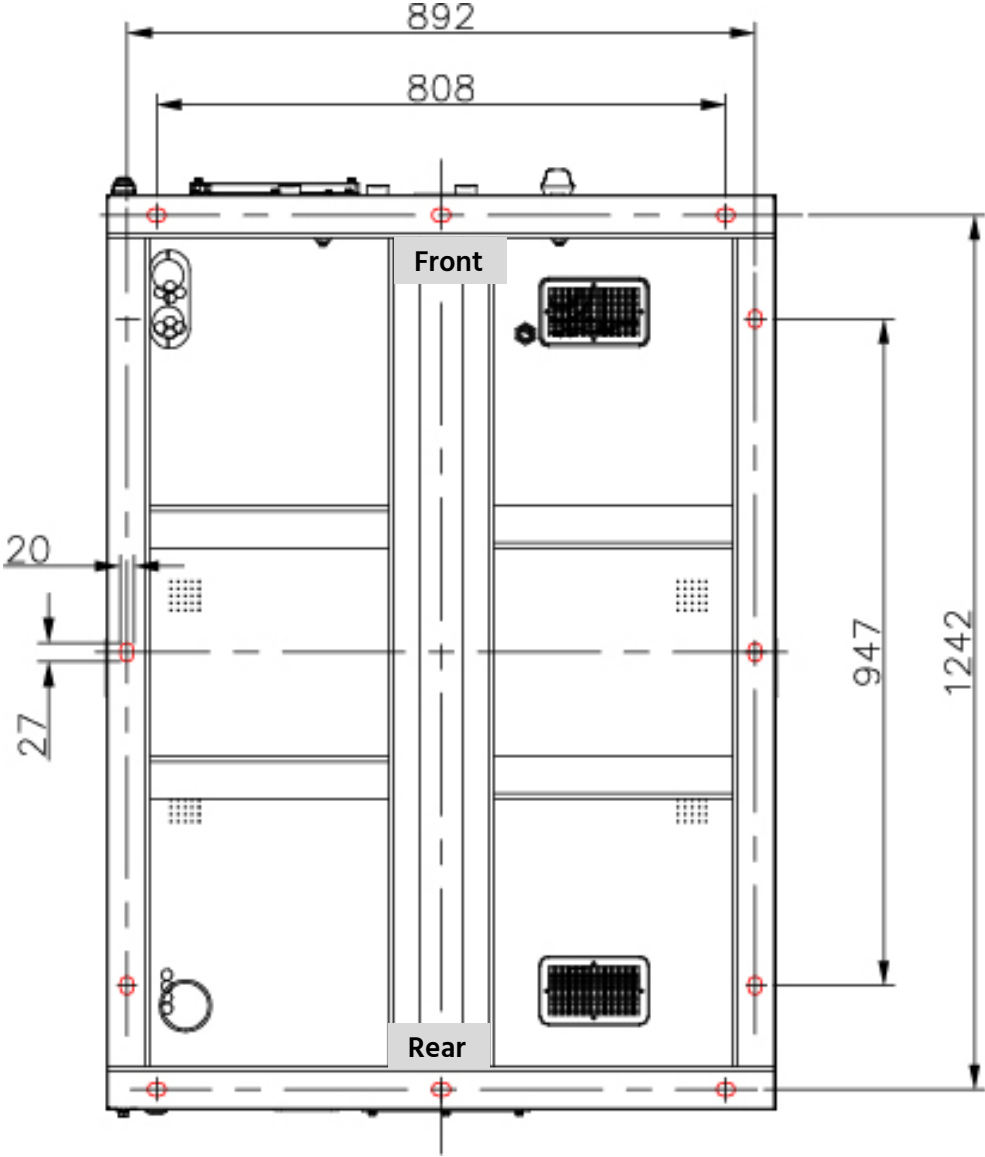

Positioning holes in the mounting foundation (Unit: mm)

- 3. Use expansion bolts to secure the cabinet to the foundation.

5 Electrical and Communication Wiring

 **DANGER**

This system is a high voltage AC system, operated by qualified and authorized person only.

 **DANGER**

When wiring the cables, ensure that the energy storage system DC side and AC side are all disconnected.

 **DANGER**

Whenever operating the system, wear suitable personal protective equipment (PPE) such as rubber gloves, rubber boots and goggles.

5.1 System Electrical Diagram

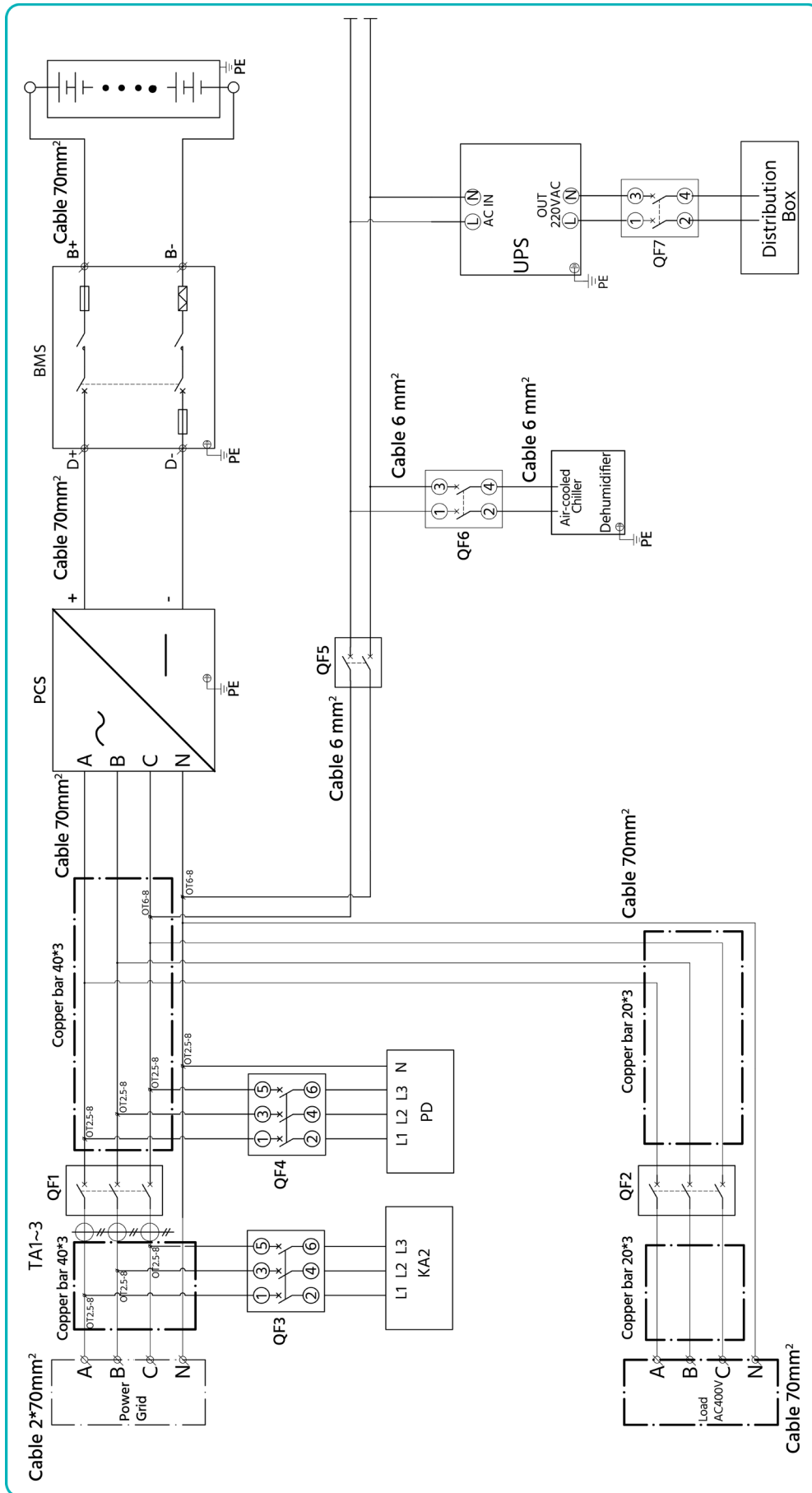

5.2 Cable Requirements and Bolt Torque

- Cable Requirements**

The wire diameter of the cables used in the outdoor cabinet must be selected in accordance with the maximum current of the AC side and DC side, and there must be a residual reservation.

Please follow the cable specifications below.

Cable	Wire Diameter Requirements	Terminal Model
AC side Phase A	70 mm ²	SC70-8
AC side Phase B	70 mm ²	SC70-8
AC side Phase C	70 mm ²	SC70-8
AC side Phase N	70 mm ²	SC70-8
Ground PE-Cable	13.3 mm ²	SC16-8
Ground PE - galvanized flat iron	3x 40 mm	/
External Ethernet communication cable	Ultra Category 6 shielded cable	RJ45
External RS485 cable	Twisted shielded cable $\geq 1,5$ mm ²	E1510

- Bolt Torque**

When fixing electrical cables, make sure that the cable terminals are completely tightened with the copper bars or terminal blocks to avoid heating or even fire of the cables caused by poor contact, and the following torque requirements should be met when the cables are connected:

Screw Size	M3	M4	M5	M6	M8	M10	M12	M16
Torque (N•m)	0.5~0.8	1.2~1.5	3~4	5~6	8.8~10.8	17.7~22.6	31.4~39.2	78.5~98.1

5.3 Grounding

⚠ DANGER

Life-threatening electric shock may occur if the grounding is insufficient or absent. Before installation, make sure that the grounding points of the battery energy storage system are stable and reliable.

- PE (to the ground): There are three grounding points for cabinet grounding on the base of the cabinet.

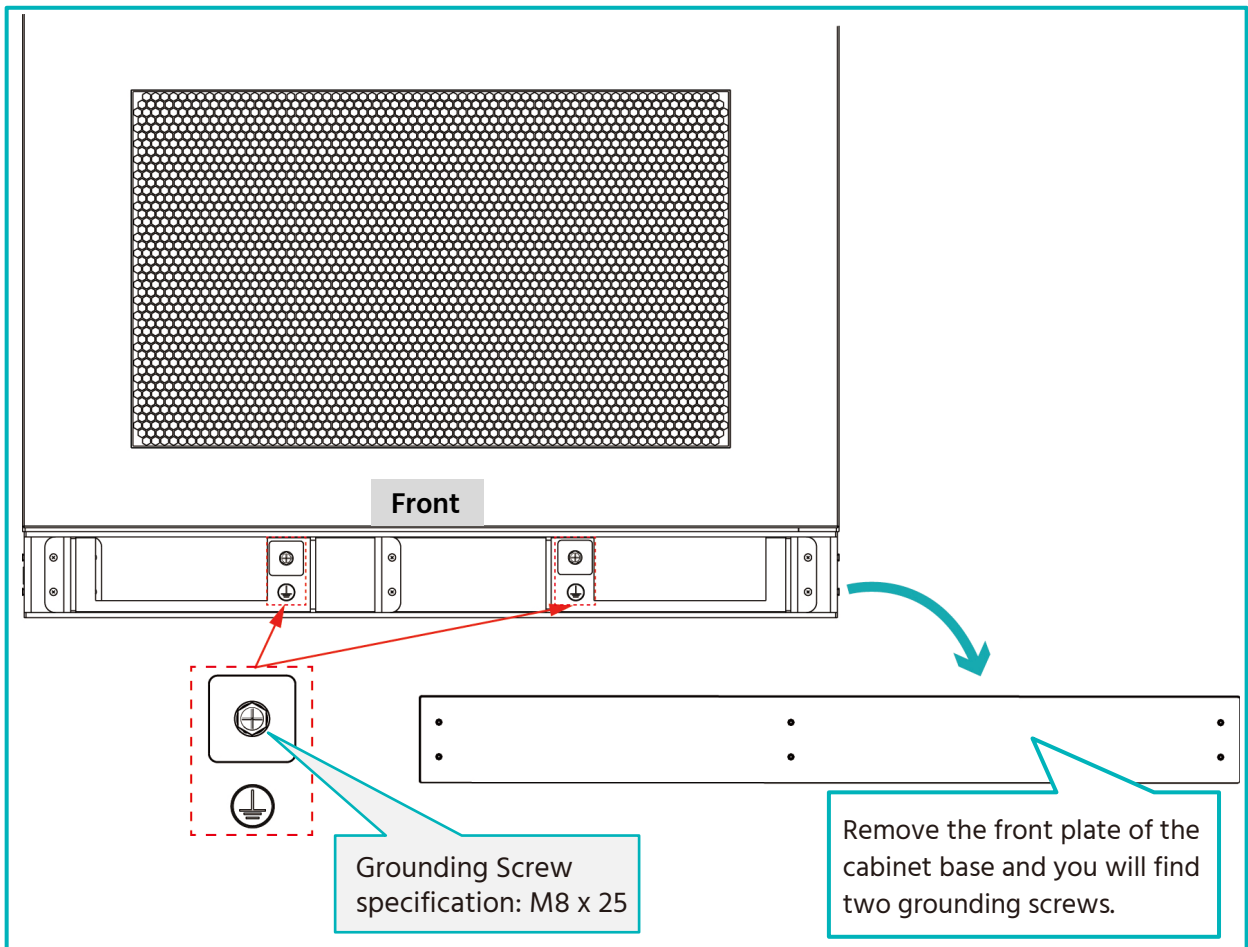

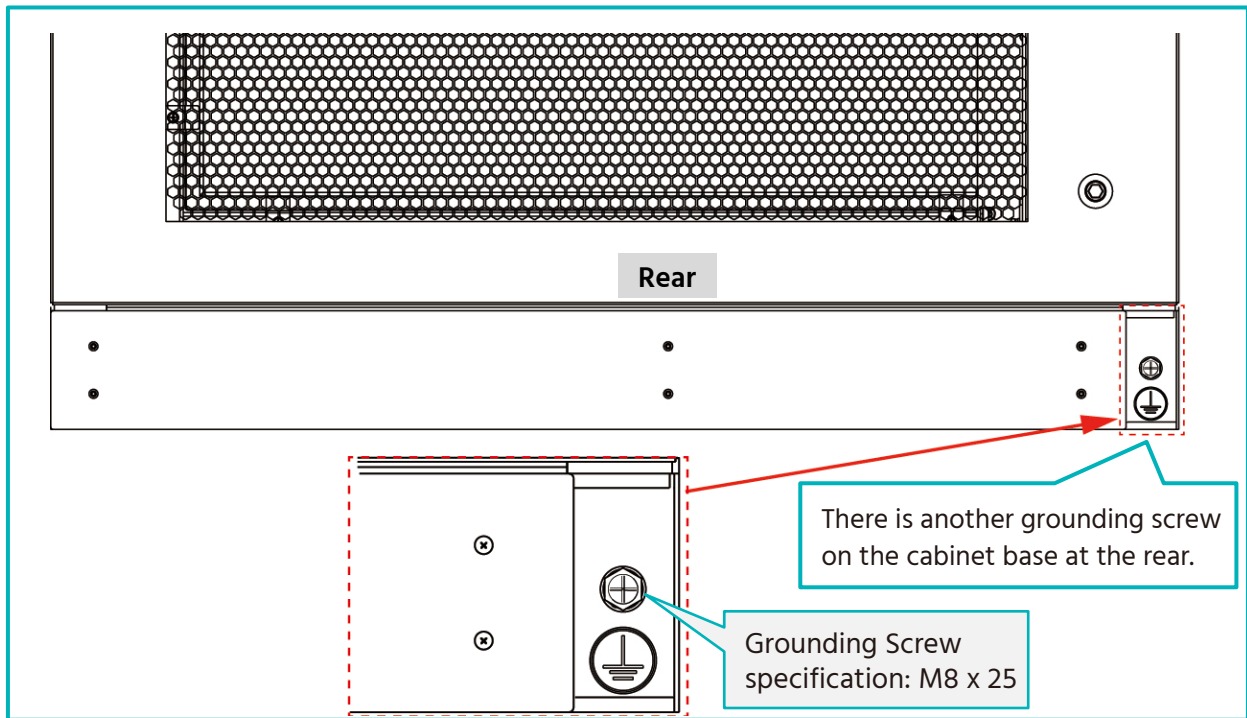

- Grounding copper bar: Grounding cable(s) connected to grounding bar inside the cabinet.

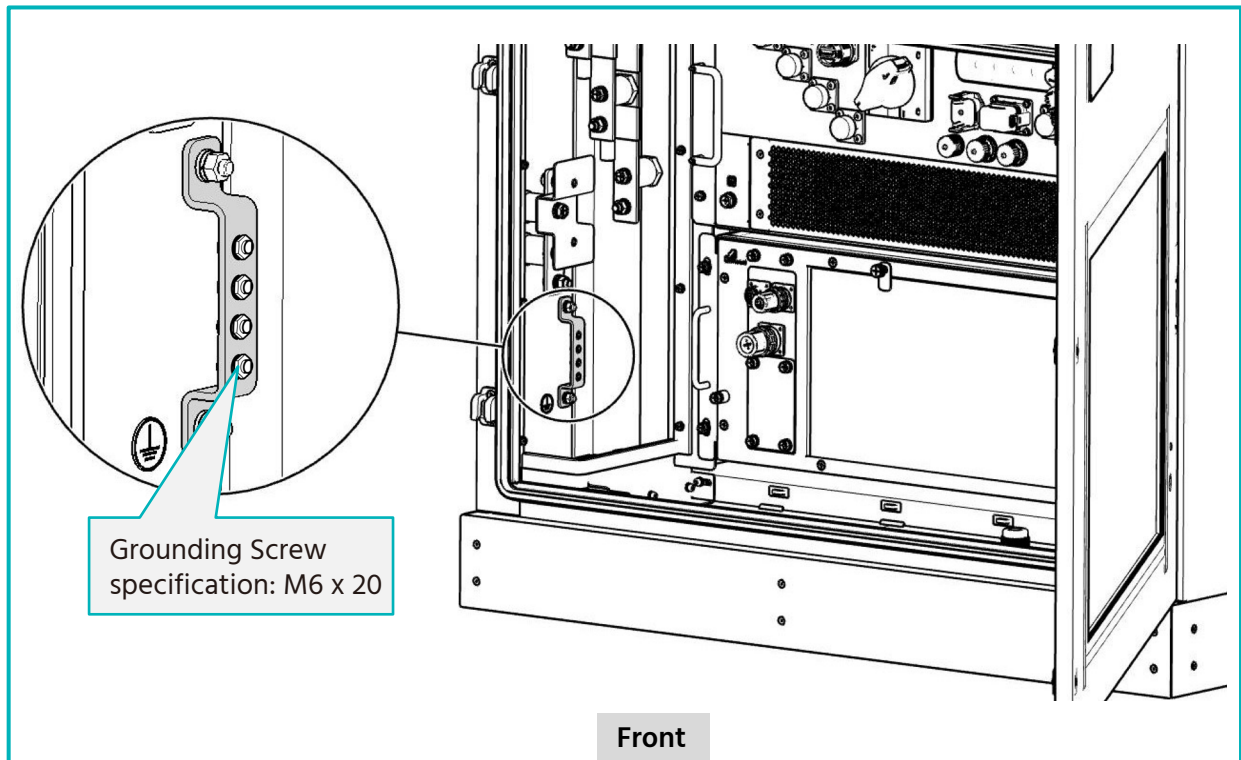





5.4 Battery Energy Storage System Connection



Do not connect the positive and negative reversely.

- (1) Connect the positive and negative electrodes of the battery modules in series.
- (2) Connect the internal and external communication cables of the battery string

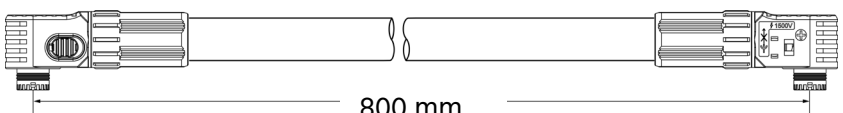
5.4.1 Cable List

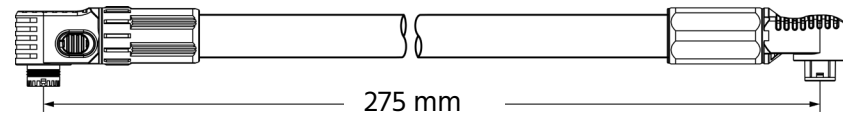
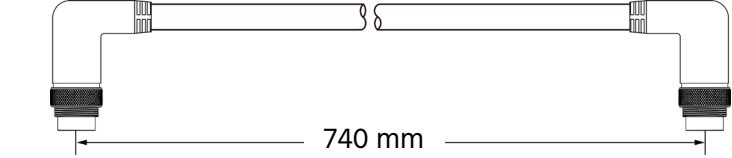
Item	Description
1	Power Cable, Orange, 2/0 AWG (BMS 'B+' to Battery Module 'B+') 
2	Power Cable, Orange, 2/0 AWG (Battery module series connection, 'B-' to 'B+') 
3	Power Cable, Black, 2/0 AWG (BMS 'B-' to Battery Module 'B-') 
4	Power Cable, Black, 2/0 AWG (BMS 'D+' to PCS 'D+') 
5	Power Cable, Orange, 2/0 AWG (BMS 'D-' to PCS 'D-') 
6	Communication Cable, Black (BMS to Battery Module/ Battery module cascade communication connection) 

5.4.2 Battery String DC Wiring

For the battery string system, the DC wiring should be done according to the drawing below. The label numbers correspond to the cable list in *section 5.4.1*.

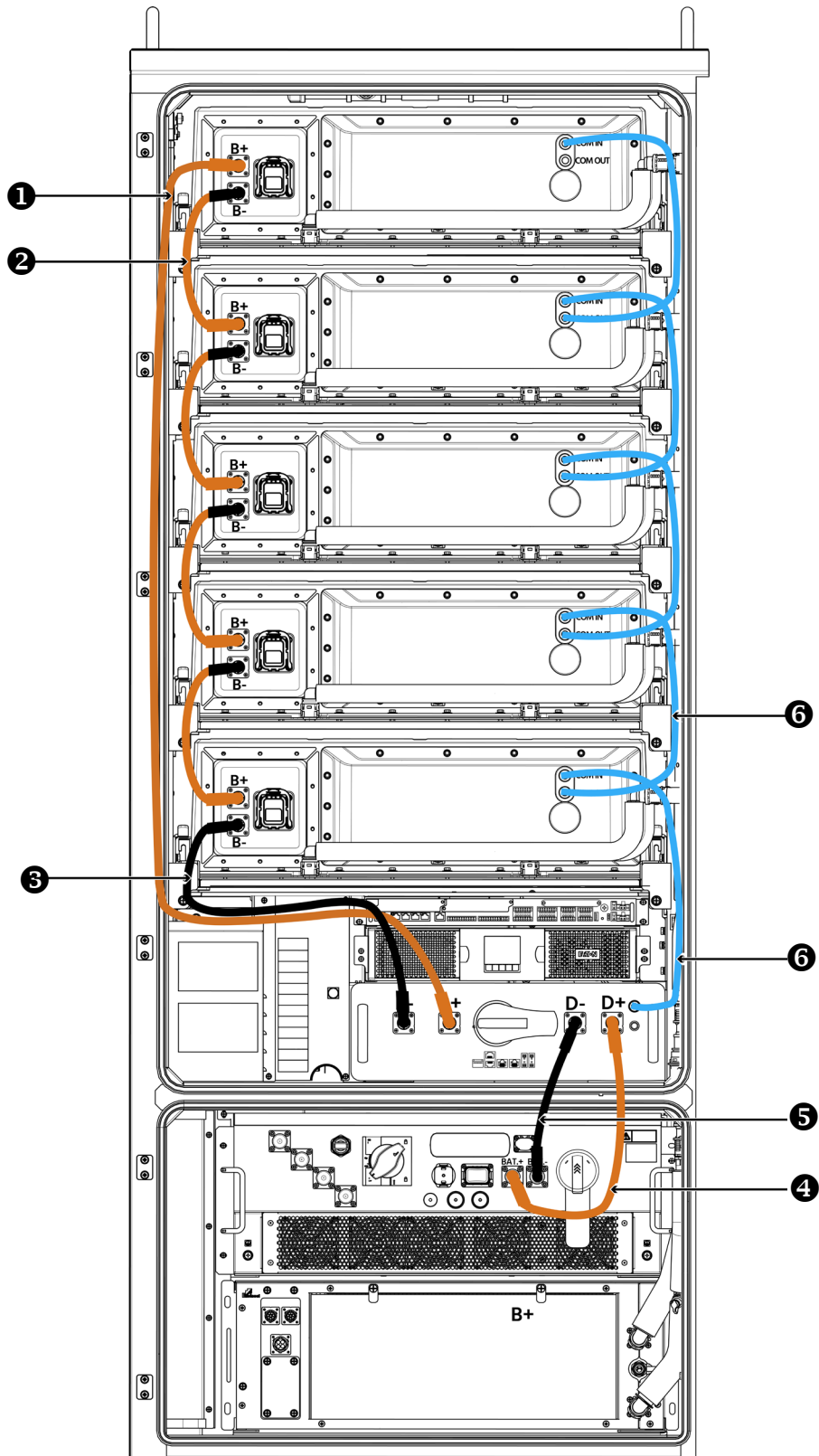

5.5 AC Side Cable Wiring

1. Connect the cables for AC load through the pre-opened hole at the bottom plate of the cabinet. Make sure to feed the cables through the gland head.

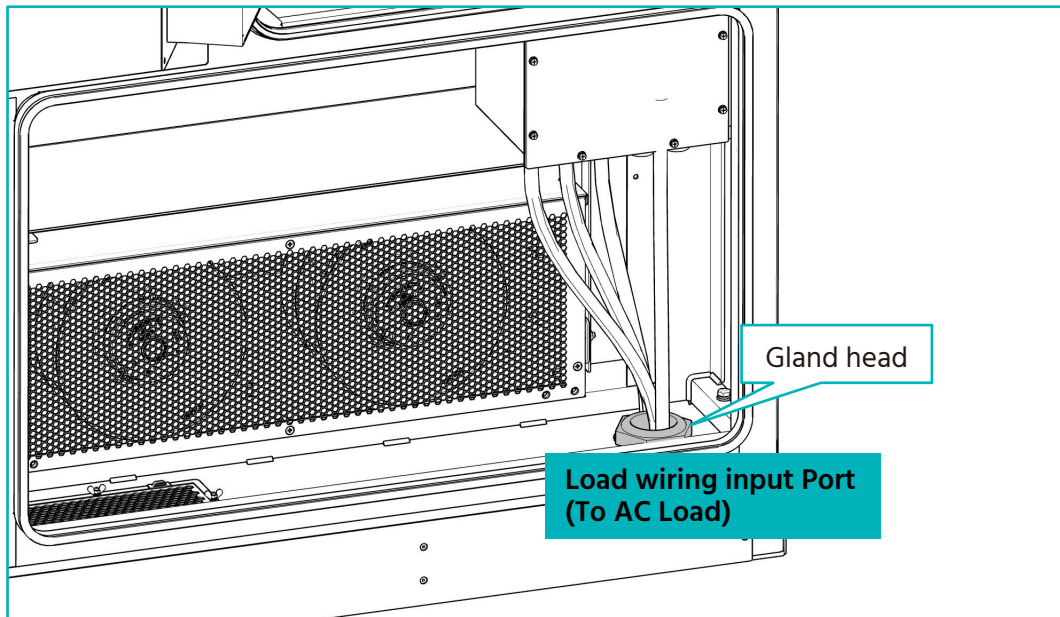

Rear of the cabinet

2. According to the labeling, connect the cables of each phase sequence in turn, three opposite sequences are not allowed.
3. Screw back the gland head in the hole.
4. Repeat the steps above to connect the cables for AC Grid. Make sure to feed the cables through rubber plugs.
5. Put back the rubber plugs in place.

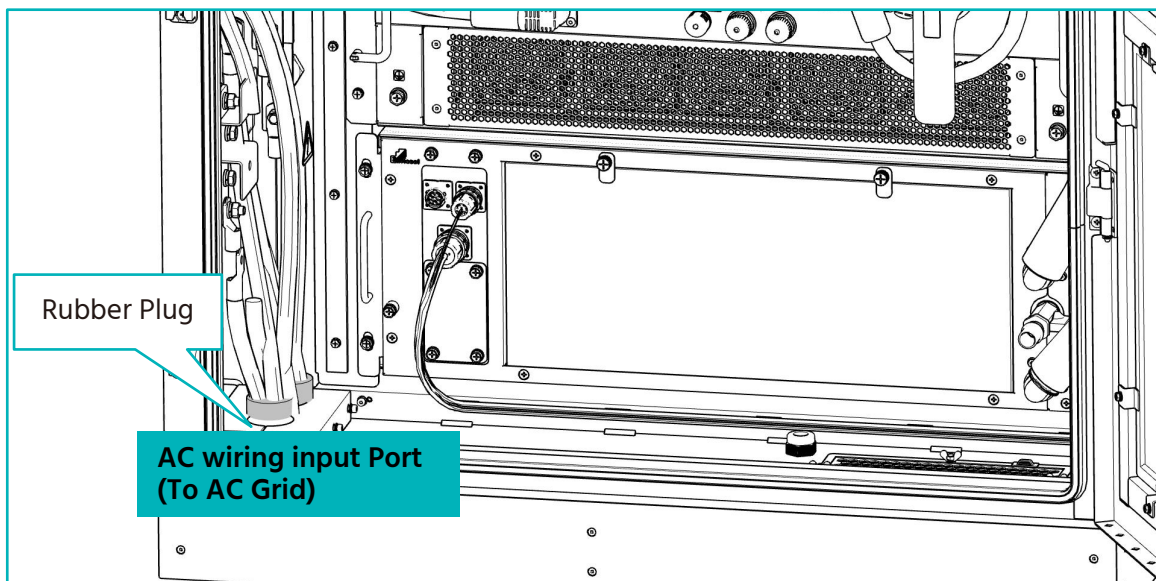

Front of the cabinet

6. Finish wiring and ensure that all connections are correct, and there is no overlap and no stress between the wires and sheet metal.

5.6 Communication Wiring Diagram

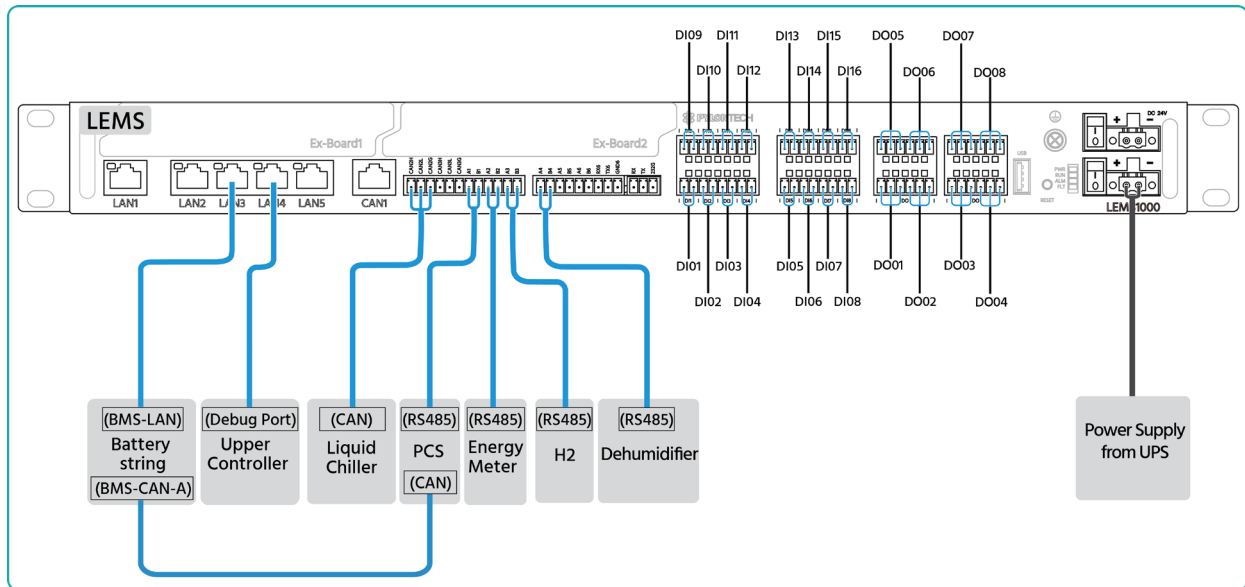

Definitions of DI & DO Ports

NO.	Item	Name	Definition
1	DI	DI01	Aerosol feedback
2		DI02	UPS failure
3		DI03	Smoke detector feedback
4		DI04	Temperature sensor feedback
5		DI05	EPO feedback
6		DI06	Standby
7		DI07	Grid Voltage Detector Relay Feedback
8		DI08	Grid Relay Feedback
9		DI09	Load Breaker Feedback
10		DI10	Black start function on/off
11		DI11	Limit switch on/off
12		DI12	Reserved
13		DI13	Reserved
14	DO	DO01	Alarm Indicator LED
15		DO02	Run Indicator LED
16		DO03	Fault Indicator LED
17		DO04	Shunt trip of Load
18		DO05	Reserved
19		DO06	Air Inlet Vent and Explosion Proof Fan
20		DO07	Grid Relay Close Control
21		DO08	Grid Relay Open Control

6 Commissioning

6.1 System Status

6.1.1 Battery String Status

The battery string status can be viewed through the “STATUS” LED on the BMS of the battery string. Following are the details:

“STATUS” LED: shows the status of battery module (Normal ●, Fault ●).

Table of LED Indicators Instructions

Battery Status	Normal/ Fault	STATUS (green)	STATUS (red)	Descriptions
		●	●	
Shut Down	/	Off	Blink 1* (slow flashing)	Indicates the battery modules in the battery system are shutdown. And the BMS is still power on.
Initialization	Normal	Blink 2* (slow flashing)	Off	Indicates the battery system is initializing.
Sleep	Normal	Blink 2* (slow flashing)	Off	Indicates Sleep Mode, to save battery power.
Idle	Normal	Light	Off	Indicates Idle Mode, to save battery power.
Standby	Normal	Light	Off	Indicates Standby Mode.
Charge	Normal	Light	Off	Indicates the battery system is charging.
Discharge	Normal	Blink 2* (slow flashing)	Off	Indicates the battery system is discharging.
Fault	Fault	Off	Blink 3* (fast flashing)	Indicates the battery system has a fault.

NOTE: The LED Blink instructions:

Blink 1 - 0.3 seconds light / 3.7 seconds off.

Blink 2 - 0.5 seconds light / 0.5 seconds off.

Blink 3- 0.1 seconds light / 0.1 seconds off.

6.2 System Turning On



WARNING

Double check all the power cables and communication cables. Ensure that the voltage of the PCS matches the voltage of the battery system. Check to make sure that all the power switches are OFF.



WARNING

The switches or breakers between PCS and battery string must be off before the battery system power on. Make sure that all micro circuit breakers in the cabinet are off.

Procedure

1. Switch on the Moulded Case Circuit Breaker QF1.
2. Switch on the Moulded Case Circuit Breaker QF2 manually (if you need to connect to the AC load).
3. Switch on the micro circuit breakers QF4 and QF5 respectively.
4. Turn on the AC Switch and DC Switch of the PCS.
5. Switch on the micro circuit breaker QF6 of the liquid chiller power supply, and the liquid chiller will start automatically.
6. Switch on the UPS following the steps below.
 - (1) Switch on the circuit breaker QF7 for the UPS input.
 - (2) After the UPS is powered on, The UPS front panel display illuminates and shows EATON logo.
 - (3) Verify that the UPS status screen shows .
 - (4) Press the  button on the UPS front panel for at least 2 seconds. The UPS front panel display changes status to "UPS starting...".
 - (5) Check the UPS front panel display for active alarms or notices. Resolve any active alarms before continuing. See *section 7.3.3*.

NOTE:

- If the  indicator is on, do not proceed until all alarms are clear. Check the UPS status from the front panel to view the active alarms. Correct the alarms and restart if necessary.
 - To ensure the UPS can provide adequate backup time, charge the UPS battery for eight hours before it is put into operation.
- (6) Verify that the  indicator illuminates solid, indicating that the UPS is operating normally and any loads are powered and protected.

- Turn on the BMS (battery control module) by switching on the circuit breaker of the control module.

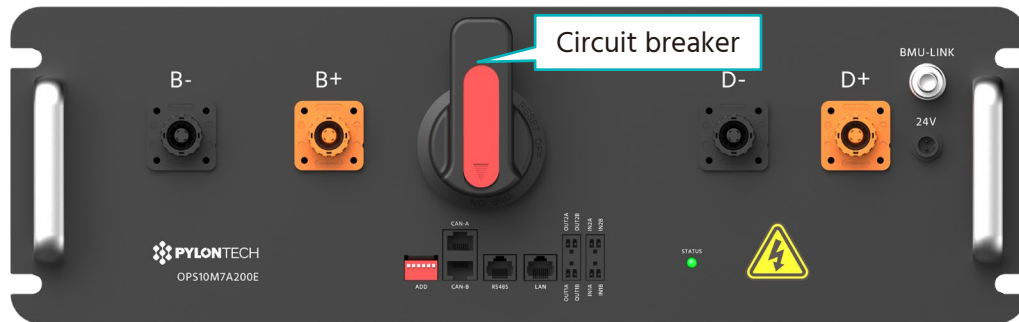

Instructions of the battery system self-check process:

The battery string's system will enter self-check mode once the system is power on.

- The status LEDs on the BMS and battery modules show green: if the BMS and all battery modules are working properly and the self-check is completed within 30 seconds, each status LED shows green, indicating that the self-check is finished.
- The status LED on the BMS turns red after 30 seconds: the BMS cannot receive signals from the upper-level device (LEMS) because of the communication outage. Then the status LED will turn red after 30 seconds. This does not mean that there is a failure, it is that the BMS is not communicating with the MBMS or PCS.
- The status LED on the BMS or battery module shows red from the beginning: if the status LED shows red from the beginning, it indicates that there is a failure of the battery. In this case, inspection of the battery module must be performed first.

WARNING

If there is any failure during the self-check, be sure to debug the failure prior to next step.

NOTE:

- When starting up for the first time, it is necessary to fully charge the battery for SOC calibration.
- After installing or restarting the system when it is not used for a long time, the entire energy storage system should be firstly fully charged.

Black Start capability:

This system has the Black-start capability that allows the system to restart the flow of electricity to the facility's auxiliary systems without the support of an external power supply in the case of an outage or blackout situation.

Press the Black Start Button (see *section 3.5, Figure 11*) to enable this function.

6.3 System Debug

Debug Step	Actions
Preparations for debug	Turn on the BESS system, referring to <i>section 5.2</i> . Remark: Besides the BESS, if other equipment has its own system starting upsteps, be sure to follow its own system operation manual.
System function test	(1) Check to make sure the power supply from the UPS is working normally. (2) Communication Test: Check that if the communication between the BESS system and communicated devices are normal.
Trial operation test.	After the system is powered on, run the system a period as a test to check it works properly.

7 Maintenance



DANGER

This system is a high voltage AC system, operated by qualified and authorized person only.

NOTE: Before maintenance or long-term storage, ensure to turn the system off.

7.1 System Turning Off

Procedure

1. Turn off the AC Switch and DC Switch of the PCS.
2. Disconnect the "QF7", "QF6", "QF5", "QF4" and "QF2" circuit breakers in the cabinet one by one.
3. To shut down the UPS, press the  button on the front panel for three seconds.
 - A confirmation message will appear.
 - When confirmed, the UPS starts to beep and shows a status of "UPS shutting OFF...". The UPS then transfers to Standby mode, and the  indicator turns off.
4. Turn off the circuit breaker of the BMS.

CAUTION

Before changing the battery module for service, be sure to charge/discharge the replaced battery at the same open circuit voltage as the other ones in the battery module system. Otherwise, the system needs long time to do balance for this new battery module.

WARNING

Do not turn off the circuit breaker during normal running status (unless emergency). Otherwise, it will cause current surge to the rest battery strings. Be sure to turn off the PCS first prior to turning off the isolating switch in normal running condition.

7.2 Routine Maintenance

Due to the influence of ambient temperature, humidity, dust, vibration, etc., the internal components of the system or equipment will be aged or worn, which will lead to the potential failure of the system or equipment. Therefore, it is necessary to carry out routine maintenance on the system to ensure its normal operation and service life.

After the system is out of operation, you must wait at least 10 minutes before carrying out maintenance or overhaul operations on the system.

After the system is shut down, pay attention to:

- Ensure that the system is not accidentally re-powered on.
- Use a multi-meter to check that the system is completely shut down.
- The possible live parts adjacent to the operating part shall be covered with insulating cloth.
- During the whole process of maintenance, it is necessary to ensure that the escape routes are completely unblocked.

Recommended Schedule of Routine Maintenance Table

Inspection Content	Inspection method	Maintenance Intervals
System operation status and environment	(1) Observe the appearance of the energy storage system for damage or deformation. (2) Check whether there is any abnormal sound in the operation of the energy storage system. (3) Check whether the parameters are correct during system operation. (4) Check whether the main devices are normal. (5) Check whether the humidity and dust in the environment around the energy storage system, and all air inlet filters are functioning properly.	Every 6 months.
System cleanliness	(1) Check the cleanliness of the components. (2) If necessary, a compressed air machine must be used to clean the system. NOTE: The system must be powered off when cleaning dust.	Every 6 months to 1 year (depending on the dust content of the environment in which it is used).
Power circuit connection check	(1) Check power cable connections for looseness and retighten to the torque specified above. (2) Check power cables and control cables for damage, especially cut marks on the skin in contact with metal surfaces.	Officially run for six months, then every six months to one year thereafter.

	(3) Check that the insulating wraps of the power cable terminals are not detached.	
Terminal and wiring connection check	<p>(1) Check whether the control terminal screws are loose and tighten them with a screwdriver.</p> <p>(2) Check whether there is any color change in the wiring copper or screws.</p> <p>(3) Visually inspect the connections such as equipment terminals and the distribution of wiring.</p> <p>(4) Check the main circuit terminals for poor contact and screw locations for signs of overheating.</p>	Officially run for six months, then every six months to one year thereafter.
Circuit breaker maintenance	<p>(1) Routine inspection of all metal components for corrosion.</p> <p>(2) Annual inspection of contactors (auxiliary switches and micro-switches) to ensure that they are in good mechanical working order.</p> <p>(3) Check the operating parameters (especially voltage and insulation).</p>	Officially run for six months, then every six months to one year thereafter.
Battery maintenance	<p>(1) Perform normal charging and discharging operations on the battery system to check whether there are any abnormalities in the operating status of the battery, and to check whether the battery system indicator status is normal.</p> <p>(2) It is recommended that the battery be fully charged and equalized on a regular basis.</p>	Every 6 months to 1 year
Aerosol fire extinguisher inspection	<p>When the fire extinguishing equipment is in normal working condition, it is necessary to check the starting device (JR10 starter box, etc.) to make sure that the line is normal.</p> <p>The fire extinguishing equipment is maintenance-free for its own validity period.</p>	Officially run for six months, then every six months to one year thereafter.
Safety Functions	<p>(1) Check the stop function of the emergency stop button.</p> <p>(2) Simulate a shutdown and check shutdown signal communication.</p> <p>(3) Check the body warning signs and other equipment markings and replace them if they are found to be blurred or damaged.</p>	Officially run for six months, then every year thereafter.

7.2.1 Battery Maintenance



The power must be turned off prior to any maintenance of the battery.

Voltage Inspection

Check the voltage of battery system through the monitor system. Check if the system is abnormal voltage. For example: Single cell's voltage is abnormally high or low.

SOC Inspection

Check the SOC of battery system through the monitor system. Check if the battery string is abnormal SOC.

Cable Inspection

Visual inspect all the cables of battery system. Check if the cables are broken, aging, or getting loose.

Balancing

The battery strings will become unbalanced if not full charged for a long time. The balancing maintenance (full charged) should be done every 3 months and is usually done automatically by communication between the system and external device.

Output Relay Inspection

Under low load condition (low current), switch the output relay to OFF and ON to hear the clicking sound, which means this relay can be turned off and on normally.

History Inspection

Analyze the history records to check if there is an accident (alarm and protection) and analyze the reasons.

Environment Inspection

Check the installation environment such as dust, water, insect etc.

7.2.2 PCS Maintenance

7.2.2.1 Electrical and fixed connection inspection

After installation and commissioning, routine inspection on follow items is recommended every three months. Record for each inspection should be made.

- Grounding connection.
- Electrical connection for DC input.
- Electrical connection for AC input.
- Connection for communication cables
- AC/DC switches and fans.

7.2.2.2 Clearing and cleaning

Before installation and commissioning, regularly clean the dust and sundries in the terminals and mesh openings of the PCS.

After installation and commissioning, regularly check ventilation and air exhaust facilities. Cleaning once every three months is recommended.

7.2.3 Liquid Chiller Maintenance

Please refer to the separate *Liquid Chiller product manual* for maintenance information.

7.3 Trouble Shooting

The common faults and solutions during the commissioning of the energy storage system are shown in the following sections. If the problems cannot be solved according to this manual, please contact us. We need the following to help you better.

- Product serial number, production date.
- Manufacturer, model, and configuration information of the equipment.
- Simple fault description.
- Failure site photos.

7.3.1 Battery String Trouble Shooting

- Section A before starting up:

Failure Mode	Possible Reason	Solution
Battery system doesn't start up after correct wiring connection and starting procedure.	Power cable issue	1. Check the wiring connection and connectivity of the power cables.
	Internal cable issue	2. Open BMS case, check the connectivity and reliability of the internal power supply cables.
	PMU issue	3. Open BMS case, use multimeter to check PMU 12VDC output and CMU LEDs. If neither is on, please swap the PMU.
	Other error	4. If problem persists, contact Pylontech service engineer.

- Section B During operation:

Error Code checked from BMS (Modbus protocol Appendix IV or CAN ID 0*4250&0*4290):

*The 'Failure Definition' and 'Failure Mode' column is reference from Pylontech Modbus protocol Appendix IV Error code 1 bit to present.

Failure Type	Failure Definition	Possible Reason	Solution
External	Input RV Err (Bit4)	D+ D- reversely connected	Check the external power cables of the polarity and connection.
External	DCOV Err input over voltage error (Bit3)	D+ D- voltage extremely higher than battery system voltage.	Check that if the PCS's voltage matches the battery system.

External	Emergency stop (Bit13)	Command by external device via dry contactor.	Command by external device, not an erroractively reported by battery system.
Current Leakage	Current Leakage Error (Bit21)	Current Leakage >25mA	With insulation gloves, disconnect the battery system and contact Pylontech service engineer.
Self-test	Self-test module Initial Error (Bit16)	Self-test failed.	1. Restart the battery system. 2. If the problem persists, contact Pylontech service engineer.
Self-test	Self-test module coulomb error (Bit15)	Self-test failed.	Contact Pylontech service engineer.
Self-test	Self-test module detecting amount error (Bit14)	Self-test failed.	Contact Pylontech service engineer.
Self-test	Safety check failure (Bit11)	Chip self-test failed.	1. Restart the battery system. 2. If the problem persists, contact Pylontech service engineer.
Self-test	Self-test volt error (Bit10)	Battery cell voltage measurement mismatch with DCBUS voltage measurement.	Restart the battery system. Check the connectivity and reliability of the power and communication cables. Swap the current measurement board or BMS. If the problem persists, contact Pylontech service engineer.
Battery cell	Battery damage error (Bit6)	Battery cell voltage measured at <2.0V.	Restart the battery system. Swap out the RED LED battery module. Use multimeter to measure the battery module power terminal voltage, if is the same as the BMS reading value, then it`s a true cell damage. Otherwise please swapthe BMU of the module.

7.3.2 PCS Trouble Shooting

Fault Information	Solution
Auxiliary power supply fault	Disconnect the AC molded case circuit breaker and the DC isolation switch. After the indicator lights are off, close the AC molded case circuit breaker, close the DC isolation switch, and check again.
Bus bar voltage fault	Disconnect the AC molded case circuit breaker and the DC isolating switch. After the indicator lights are off, close the AC molded case circuit breaker, close the DC isolation switch, and check again.
Excessive DC component	Wait for one minute after the PCS is reconnected. Shutdown, disconnect the AC molded case circuit breaker and disconnect the DC isolation switch. After the indicator lights are off, close the AC molded case circuit breaker, close the DC isolation switch, and check again.
Insulation resistance detection fault	Disconnect the AC molded case circuit breaker and disconnect the DC isolation switch. After the indicator lights are off, close the AC molded case circuit breaker, close the DC isolation switch, and check again.
Grid voltage fault	Wait for the grid to return to normal, and the system will reconnect. Check if the grid voltage and frequency meet the standard.
Grid frequency fault	Wait for the grid to return to normal, and the system will reconnect. Check if the grid voltage and frequency meet the standard.
Grid reconnection fault	Wait for the grid to return to normal, and the system will reconnect. Check if the grid voltage and frequency meet the standard.
Internal communication fault	Disconnect the AC molded case circuit breaker and disconnect the DC isolation switch. After the indicator lights are off, close the AC molded case circuit breaker, close the DC isolation switch, and check again.
Pre-synchronous fault	Disconnect the AC molded case circuit breaker and disconnect the DC isolation switch. After the indicator lights are off, close the AC molded case circuit breaker, close the DC isolation switch, and check again.
Overcurrent fault	Disconnect the AC molded case circuit breaker and disconnect the DC isolation switch. After the indicator lights are off, close the AC molded case circuit breaker, close the DC isolation switch, and check again.
Phase lock fault	Shut down and power off the energy storage system, disconnect the distribution circuit breaker. Check if the grid interface wiring is normal. Check if the grid voltage and frequency meet the standard.
Battery voltage fault	Check if the battery voltage exceeds the normal range. If the battery voltage exceeds the normal range, please check the battery cluster.

Overtemperature fault	Check if the ambient temperature is within the allowable range of the PCS.
Fan Fault	Disconnect the AC molded case circuit breaker and disconnect the DC isolation switch. After the indicator lights are off, close the AC molded case circuit breaker, close the DC isolation switch, and check again.

- Please check the fault code of the PCS. If a message is displayed, please note it before proceeding further.
- Try the solutions shown in the table above.
- If the PCS indicator light does not on, please check the following to ensure that the current state of the installation allows the device to operate normally:
- Whether the PCS is located in a clean, dry and well-ventilated place. Whether the DC input switch is closed.
- Whether the cable size is appropriate.
- Whether the input and output connections and wiring are in good condition.
- Whether the indicator light and communication stick are connected correctly and not damaged.

Contact Customer Service for further assistance with system installation details and the model and serial number of the product.

7.3.3 UPS Trouble Shooting

Problem and Possible Reason		Solution
The UPS can't be started.	The battery connection is incorrect.	Check that the battery connector is properly connected.
	NOT pressing the ON/OFF button.	Press the ON/OFF button to turn on the UPS.
	The UPS is not connected to the grid.	Check that both ends of the power cable between the UPS and the grid are securely connected.
	The voltage is too low or there's no grid voltage.	Use a table lamp to check the grid power supply connected to the UPS. If the light is very dim, check the grid voltage.
The UPS can't be shut down.	NOT pressing the ON/OFF button.	Press the ON/OFF button to turn off the UPS.
	Internal fault of the UPS.	DO NOT attempt to use UPS. Unplug the UPS and send it for repair in time.
UPS cannot provide the expected backup time.	The UPS battery was weakened by a recent power outage or the battery is at the end of its working life.	Charge the battery. The battery should be recharged after a long period of power outage. Frequent use or the high temperature operation will reduce the battery's working life. If the battery is at the end of its working life, consider replacing the battery even though the indicator LED has not yet lighted up.
Bypass overload alarm, UPS makes continuous alarm sound.	Overload of the UPS.	The connected device exceeds the maximum load specified in the technical specifications. The alarm will continue until the overload is eliminated. Disconnect unnecessary devices from the UPS to resolve overload issues.
Failure LED lights up.	Internal fault of the UPS.	DO NOT attempt to use UPS. Turn off the UPS and send it for repair in time.
Battery replacement indicator LED lights up.	(A short beep sounds every two seconds.) The battery is disconnected.	Check that if the battery connector is intact.
	Too low battery power.	Charge the battery for 24 hours. Then perform a self-check. If the problem persists after recharging, replace the battery.
	(The UPS makes a short beep for one minute and the battery replacement LED lights up. UPS repeats the alarm every 5 hours.) Battery self-check fails.	Perform a self-check procedure after 24 hours of battery charging to confirm the condition of battery replacement. If the battery self-test is successful, the alarm will stop and the LED light will go off.

Despite the presence of grid power, the UPS still runs on batteries.	The grid voltage is too high, too low, or unstable. Generators powered by cheap fuel cannot provide a stable voltage.	Switch the UPS to another electrical outlet. Test the input voltage according to the grid voltage display.
On-line LED light	No LED lights up.	The UPS is running on battery or is not started.
	LED flashes.	The UPS is performing internal self-check.

7.3.4 Liquid Chiller Trouble Shooting

Please refer to the separate *Liquid Chiller product manual* for trouble shooting.

7.4 Emergency Disposal (EPO)

In case of fire or any situation beyond the control of anyone, please immediately press the emergency stop button (EPO) to stop the system. DO NOT touch the EPO during normal operation. To restore the system, firstly rotate the EPO button in the operating direction on the door to make the button pop up, and then power on the system according to the power on steps.

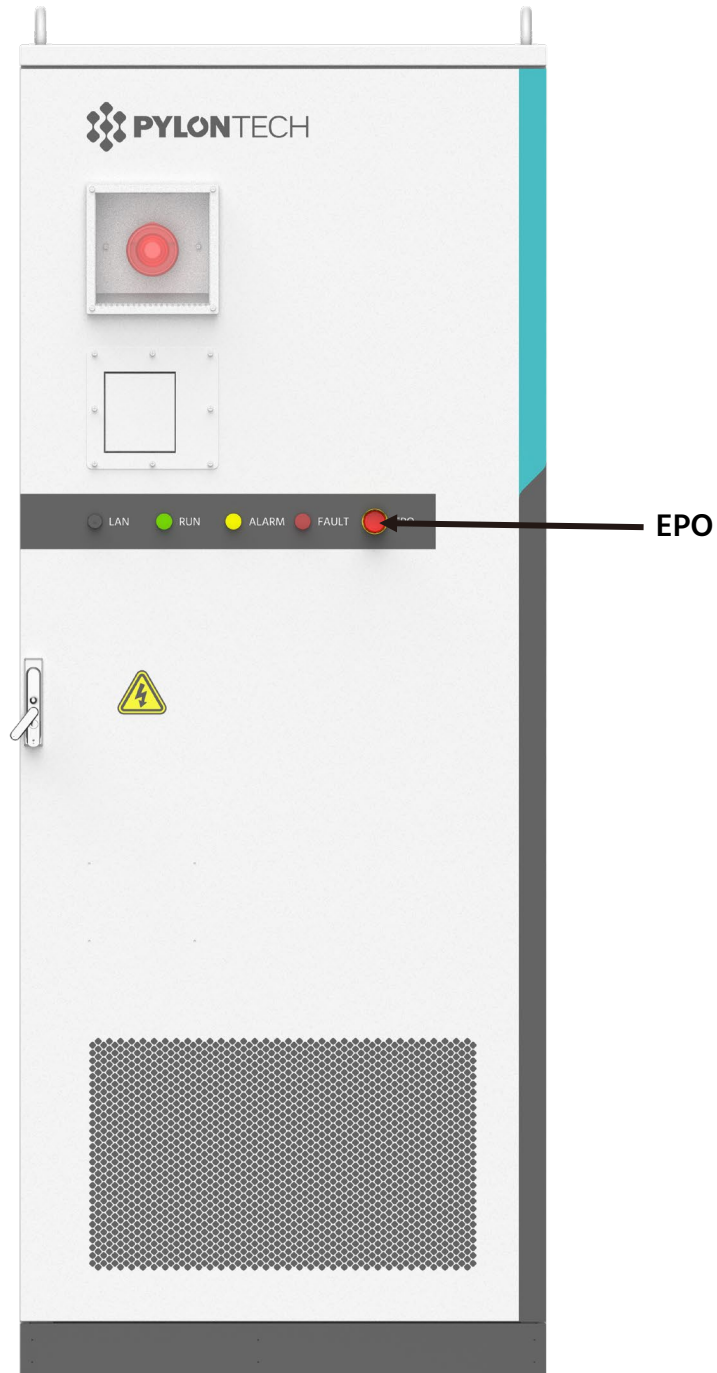

8 Shipment and Storage

8.1 Shipment

The outdoor battery cabinet is handled by forklift or hoisting.

- The indoor battery cabinet is transported with battery. Therefore, ALWAYS avoid violent impact during handling.
- It should be fixed firmly during transportation, and no displacement is allowed in the carriage.
- During transportation, it should be placed and transported in strict accordance with the vertical direction, the tilt angle $\leq 15^\circ$. DO NOT transport the cabinet horizontally or sideways to avoid device vibration.
- DO NOT transport the cabinet with flammable, explosive, and corrosive items during transportation.
- DO NOT store the cabinet in an open warehouse during transit.
- DO NOT expose the cabinet to rain, snow or liquid substances.

Single cell's SOC shall remain around 55% according to customer requirement before shipment.

The remaining capacity of battery, after shipment and before charging, is determined by the storage time and condition.

The battery modules should meet the UN38.3 certificate standard. In particular, special rules for the carriage of goods on the road and the current dangerous goods law should be observed.

8.2 Storage

Before storage the battery should be charged to 50~55% SOC.

For long-term storage, e.g. if it needs to be stored for a long time (more than 3 months), the battery should be stored in the temperature range for 5~45°C, relative humidity <65% clean, well-ventilated, and corrosive-gas-freed environment.

It is recommended to discharge and charge the battery every 3 months, and the longest discharge and charge interval shall not exceed 6 months.

CAUTION

If not following the above instructions for long term storage of the battery, the cycle life will decrease relative heavily.



Pylon Technologies Co., Ltd.

No. 300, Miaoqiao Road, Kangqiao Town

Pudong New Area, Shanghai, 201315, China

T +86-21-51317699 | **F** +86-21-51317698

E service@pylontech.com.cn

W www.pylontech.com.cn