

INTEG **M** HYBRID INVERTER

Solinteg MHT-25~50K
Hybrid Inverter









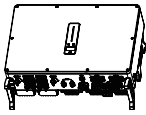
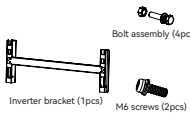
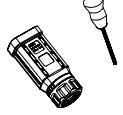

Quick Installation Guide

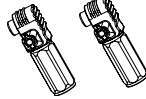
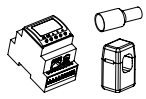
ENGLISH VERSION

1 Installation

A Check Packing List

 Inverter 1pcs	 Bolt assembly (4pcs) Inverter bracket (1pcs) M6 screws (2pcs)	 AC connector set (3 pcs)	 PV terminal MHT-25-50K 8 pairs / MHT-40-50K-P 6 pairs
 Battery terminal (1 pairs)	 Meter with 3 CTs 1pcs	 COM2 connector set (1pcs)	 COM3 connector set (1pcs)
 Monitoring device 1pcs	 10m meter communication cable 1pcs 3m battery communication cable 1pcs	 PE terminal 1pcs	 User Manual User guide

B Installation Location

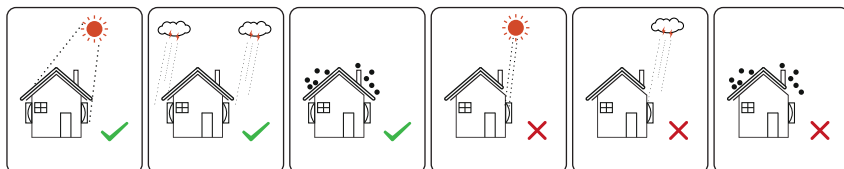

C Installation Space

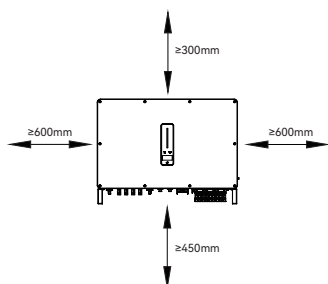

D Installation Angle

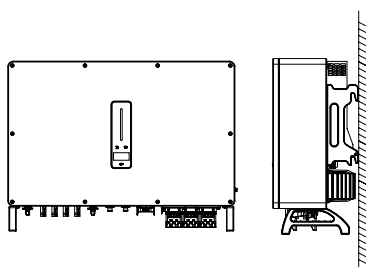

E Mark the Position and Drill Holes

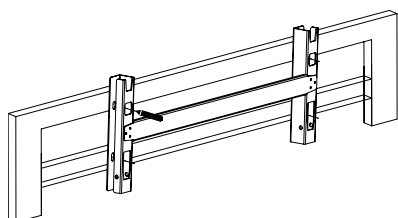

F Fix Wall Bracket

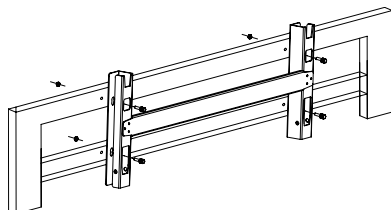

G Mounting Inverter

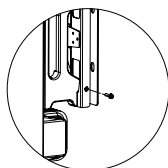
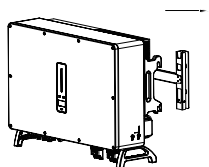

H Grounding Terminal Connection

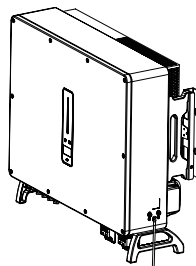

2 Electrical Connection

A Cable Requirements

Cable types	Cable requirements	
	Outside diameter	Conductor core section
AC cable	20.0-30.0 mm	10.0-25.0mm ² (Flexible cable)
		10.0-35.0mm ² (Hard cable)
PV cable	5.9-8.8 mm	4.0 mm ²
Battery power cable	9.8±0.2 mm	25.0 mm ²

Please use the cable specified in the above table. If the conductor core of the cable is too small, which may cause poor contact between the terminal and cable.

C AC Connection

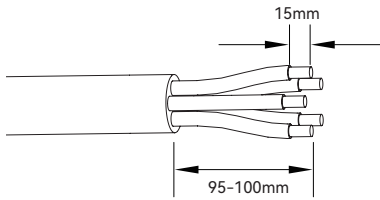

①

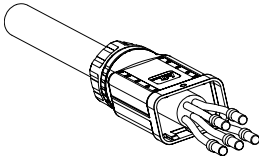

②

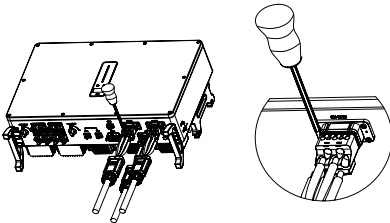

③

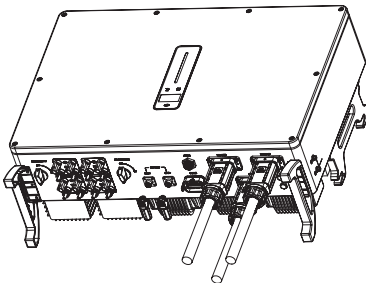

④

D Monitoring Device Installation

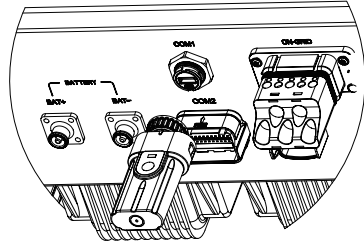

E Meter and CT Connection

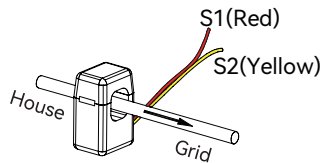
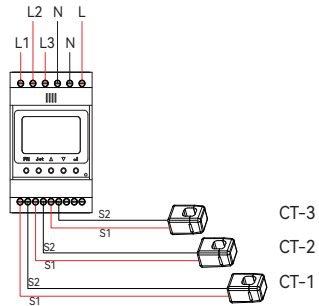
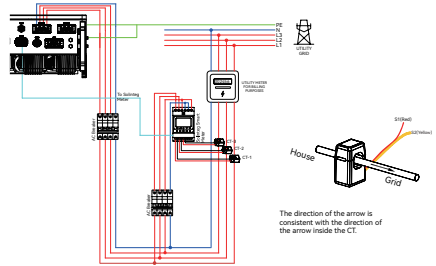

Meter Terminals Definition

No.	Definition		Function
	ACR10R	RMM	
1		L1	L1/L2/L3/N connect to grid to detect power grid voltage
2		L2	
3		L3	
4		N	
5		L1-S1	To detect the CT current and direction
6		L1-S2	
7		L2-S1	
8		L2-S2	
9		L3-S1	
10		L3-S2	
11	/	PE	Ground connection
12	L	/	Power supplied from grid
13	N	/	
RS485	/	Reserve	Communicate with hybrid inverter
	RS485	RS485-2	
ANT	/	Reserve	
LAN	/	Reserve	
Type-C	/	Type-C	Specified Debug Interface. Do not use it by non-professionals

F Communication Connection

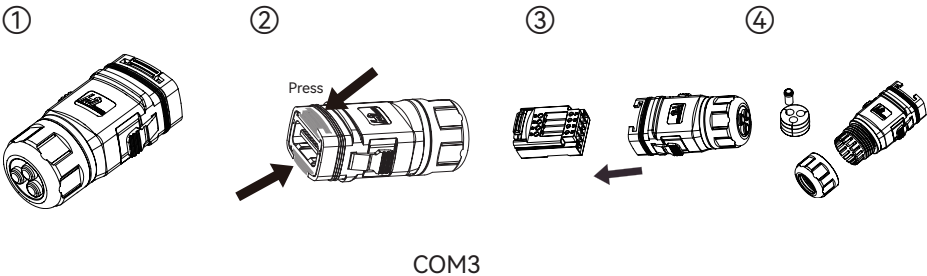
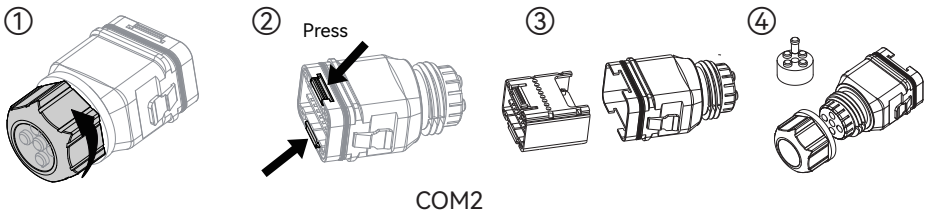

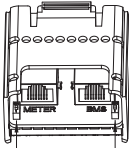

Terminating resistor for CAN(Parallel) RS485(EMG)

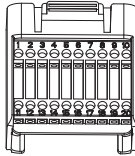

COM2

Pin	Definition	Function
METER (RJ45-1)	RS 485	Communicate with Meter
BMS (RJ45-1)	CAN	Communicate with BMS
1	COM	DO-1 (Multifunction Relay)
2	NO (Normally Open)	
3-4	/	Reserved
5	DRM4/8	DRED For Australia and New Zealand
6	DRM3/7	
7	DRM2/6	
8	DRM1/5	
15	COM D/0	Reserved
16	REF D/0	
9-10	/	Fast stop
11	Fast stop +	
12	Fast stop -	EMS
13	485 B1	
14	485 A1	
17	CANL_P	CAN for parallel connection of inverters
18	CANH_P	
19-20	/	Reserved

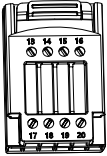
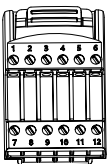

COM3

Pin	Definition	Function
1-6	/	Reserved
7	COM	DO-2 (Multifunction Relay)
8	NO	
9-10	/	Reserved
11	COM	DO-3 (Multifunction Relay)
12	NC	
13-16	/	Reserved
17	4-20mA_OUT	4-20mA analog output
18	GND	
19	GND	0-10V analog output
20	0-10V_OUT	

Connect the Meter and BMS Communication Cables

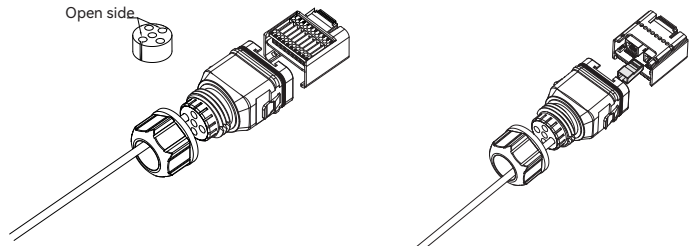

COM2

Connect Other Cables

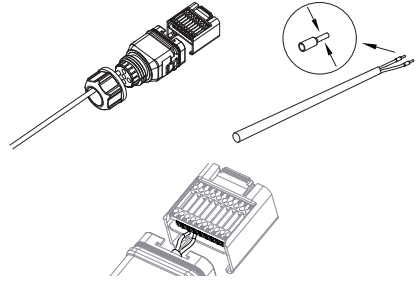
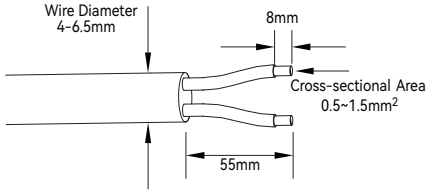

COM2

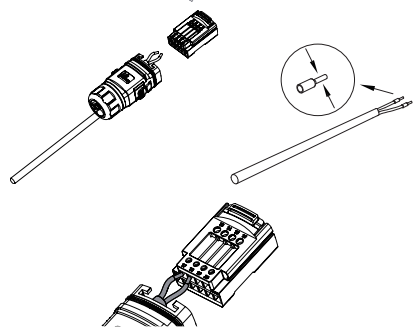
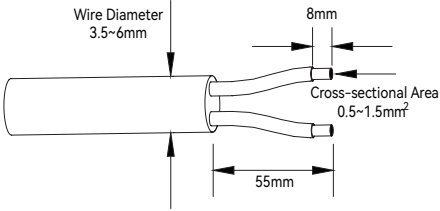

COM3

Installing the COM Connector

①

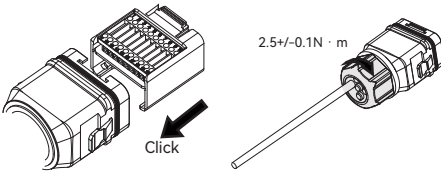

COM2

③

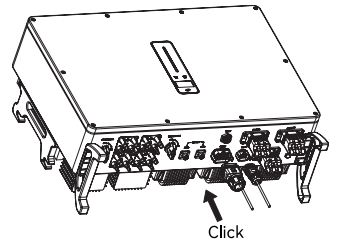

②

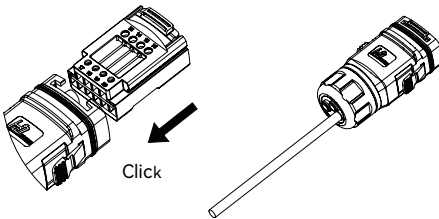

COM3

G PV String Connection

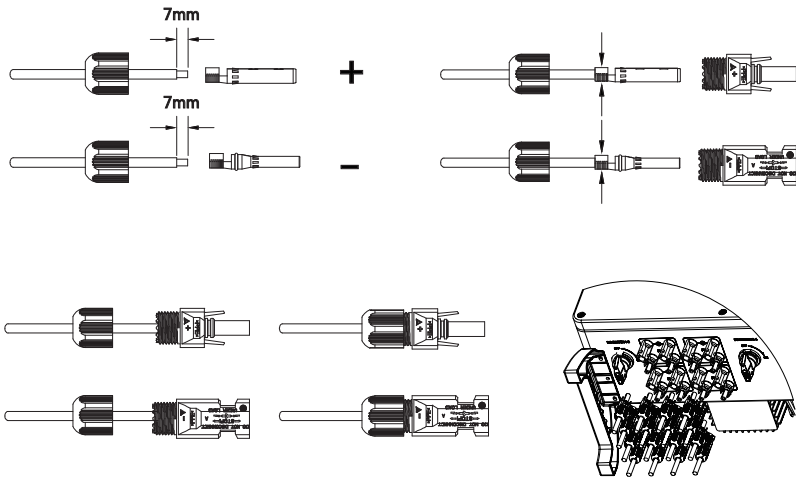

PV Max. Input voltage is 850V , otherwise inverter will be waiting.

H Power Cable of the Battery Connection

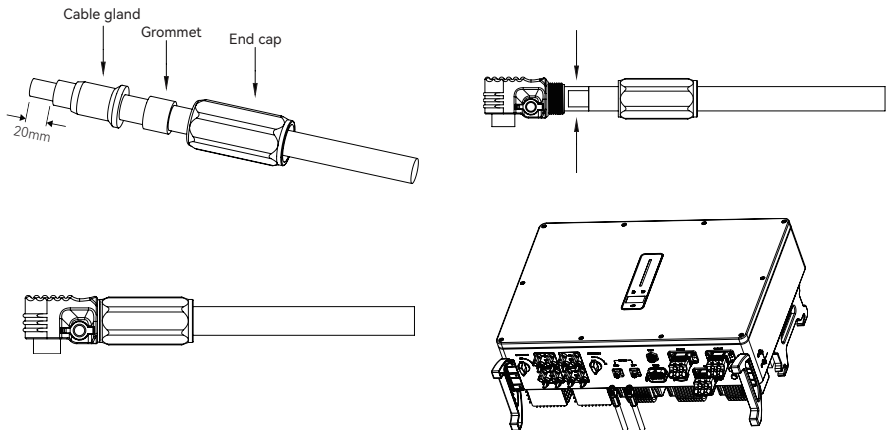

I N T E G R A T E S O L A R I N T E L L I G E N T



www.solinteg.com

M11-00012-01