

**SUN2000-(12KTL-25KTL)-M5 Series**

# **User Manual**

**Issue**                02  
**Date**                 2022-09-30



**Copyright © Huawei Digital Power Technologies Co., Ltd. 2022. All rights reserved.**

No part of this document may be reproduced or transmitted in any form or by any means without prior written consent of Huawei Digital Power Technologies Co., Ltd.

## **Trademarks and Permissions**



HUAWEI and other Huawei trademarks are the property of Huawei Technologies Co., Ltd.

All other trademarks and trade names mentioned in this document are the property of their respective holders.

## **Notice**

The purchased products, services and features are stipulated by the contract made between Huawei Digital Power Technologies Co., Ltd. and the customer. All or part of the products, services and features described in this document may not be within the purchase scope or the usage scope. Unless otherwise specified in the contract, all statements, information, and recommendations in this document are provided "AS IS" without warranties, guarantees or representations of any kind, either express or implied. The information in this document is subject to change without notice. Every effort has been made in the preparation of this document to ensure accuracy of the contents, but all statements, information, and recommendations in this document do not constitute a warranty of any kind, express or implied.

## **Huawei Digital Power Technologies Co., Ltd.**

Address: Huawei Digital Power Antuoshan Headquarters

Futian, Shenzhen 518043

People's Republic of China

Website: <https://e.huawei.com>

# About This Document

## Purpose

This document describes the SUN2000-12KTL-M5, SUN2000-15KTL-M5, SUN2000-17KTL-M5, SUN2000-20KTL-M5, SUN2000-25KTL-M5, SUN2000-15KTL-ZHM5, SUN2000-17KTL-ZHM5, SUN2000-20KTL-ZHM5, and SUN2000-25KTL-ZHM5 (also referred to as SUN2000) in terms of their installation, electrical connections, commissioning, maintenance, and troubleshooting. Before installing and operating the SUN2000, ensure that you are familiar with the safety precautions as well as features and functions of the SUN2000 provided in this document.





## Intended Audience

This document is intended for:

- Installers
- Users

## Symbol Conventions

The symbols that may be found in this document are defined as follows.

Symbol	Description
 <b>DANGER</b>	Indicates a hazard with a high level of risk which, if not avoided, will result in death or serious injury.
 <b>WARNING</b>	Indicates a hazard with a medium level of risk which, if not avoided, could result in death or serious injury.
 <b>CAUTION</b>	Indicates a hazard with a low level of risk which, if not avoided, could result in minor or moderate injury.
 <b>NOTICE</b>	Indicates a potentially hazardous situation which, if not avoided, could result in equipment damage, data loss, performance deterioration, or unanticipated results. NOTICE is used to address practices not related to personal injury.

Symbol	Description
 NOTE	Supplements the important information in the main text. NOTE is used to address information not related to personal injury, equipment damage, and environment deterioration.

## Change History

Changes between document issues are cumulative. The latest document issue contains all updates made in previous issues.

### Issue 02 (2022-09-30)

Updated [4.6 \(Optional\) Installing a Junction Box](#).

Updated [5.2 Preparing Cables](#).

Updated [5.5 Installing AC Output Power Cables and Signal Cables](#).

Updated [7.2.1.1 Grid-tied Point Control](#).

Updated [8.3 Troubleshooting](#).

Updated [10.1 SUN2000-\(15KTL-25KTL\)-ZHM5 Technical Specifications](#).

Updated [10.2 SUN2000-\(12KTL-25KTL\)-M5 Technical Specifications](#).

Updated [E Rapid Shutdown](#).

### Issue 01 (2022-06-15)

This issue is used for first office application (FOA).

---

# Contents

---

<b>About This Document.....</b>	<b>ii</b>
<b>1 Safety Information.....</b>	<b>1</b>
1.1 General Safety.....	1
1.2 Personnel Requirements.....	2
1.3 Electrical Safety.....	3
1.4 Installation Environment Requirements.....	4
1.5 Mechanical Safety.....	4
1.6 Commissioning.....	6
1.7 Maintenance and Replacement.....	6
<b>2 Overview.....</b>	<b>7</b>
2.1 Product Introduction.....	7
2.2 Appearance.....	10
2.3 Label Description.....	12
2.4 Working Principles.....	12
2.4.1 Working Modes.....	12
2.4.2 Circuit Diagram.....	13
<b>3 SUN2000 Storage.....</b>	<b>15</b>
<b>4 Installation.....</b>	<b>16</b>
4.1 Checking Before Installation.....	16
4.2 Tools.....	17
4.3 Determining the Installation Position.....	18
4.3.1 Environment Requirements.....	18
4.3.2 Space Requirements.....	19
4.4 Moving an Inverter.....	20
4.5 Installing an Inverter.....	21
4.6 (Optional) Installing a Junction Box.....	23
<b>5 Electrical Connections.....</b>	<b>25</b>
5.1 Precautions.....	25
5.2 Preparing Cables.....	26
5.3 Connecting the Ground Cable.....	28
5.4 Installing DC Input Power Cables.....	31

5.5 Installing AC Output Power Cables and Signal Cables.....	34
5.6 (Optional) Installing the Smart Dongle and Anti-theft Components.....	39
<b>6 Commissioning.....</b>	<b>40</b>
6.1 Check Before Power-On.....	40
6.2 Powering On the System.....	41
<b>7 Man-Machine Interactions.....</b>	<b>46</b>
7.1 App Commissioning.....	46
7.1.1 Downloading the FusionSolar App.....	46
7.1.2 (Optional) Registering an Installer Account.....	47
7.1.3 Creating a PV Plant and a User.....	48
7.1.4 (Optional) Setting the Physical Layout of the Smart PV Optimizers.....	48
7.1.5 Detecting Optimizer Disconnection.....	48
7.2 Parameters Settings.....	49
7.2.1 Energy Control.....	49
7.2.1.1 Grid-tied Point Control.....	49
7.2.1.2 Apparent Power Control on the Inverter Output Side.....	54
7.2.2 AFCI.....	55
<b>8 Maintenance.....</b>	<b>58</b>
8.1 Powering Off the System.....	58
8.2 Routine Maintenance.....	58
8.3 Troubleshooting.....	59
8.4 Replacing a Fan.....	70
<b>9 Handling the Inverter.....</b>	<b>71</b>
9.1 Removing the SUN2000.....	71
9.2 Packing the SUN2000.....	71
9.3 Disposing of the SUN2000.....	71
<b>10 Technical Specifications.....</b>	<b>72</b>
10.1 SUN2000-(15KTL-25KTL)-ZHM5 Technical Specifications.....	72
10.2 SUN2000-(12KTL-25KTL)-M5 Technical Specifications.....	79
<b>A Grid Codes.....</b>	<b>87</b>
<b>B Device Commissioning.....</b>	<b>89</b>
<b>C Resetting Password.....</b>	<b>91</b>
<b>D Locating Insulation Resistance Faults.....</b>	<b>92</b>
<b>E Rapid Shutdown.....</b>	<b>96</b>
<b>F NS Protection.....</b>	<b>98</b>
<b>G Preconfigured Certificate Disclaimer.....</b>	<b>99</b>
<b>H Acronym and Abbreviation.....</b>	<b>100</b>

# 1 Safety Information

---

## 1.1 General Safety

### Statement

Before installing, operating, and maintaining the equipment, read this document and observe all the safety instructions on the equipment and in this document.

The "NOTICE", "CAUTION", "WARNING", and "DANGER" statements in this document do not cover all the safety instructions. They are only supplements to the safety instructions. Huawei will not be liable for any consequence caused by the violation of general safety requirements or design, production, and usage safety standards.

Ensure that the equipment is used in environments that meet its design specifications. Otherwise, the equipment may become faulty, and the resulting equipment malfunction, component damage, personal injuries, or property damage are not covered under the warranty.

Follow local laws and regulations when installing, operating, or maintaining the equipment. The safety instructions in this document are only supplements to local laws and regulations.

Huawei will not be liable for any consequences of the following circumstances:

- Operation beyond the conditions specified in this document
- Installation or use in environments which are not specified in relevant international or national standards
- Unauthorized modifications to the product or software code or removal of the product
- Failure to follow the operation instructions and safety precautions on the product and in this document
- Equipment damage due to force majeure, such as earthquakes, fire, and storms
- Damage caused during transportation by the customer
- Storage conditions that do not meet the requirements specified in this document

## General Requirements



Do not work with power on during installation.

---

- Do not install, use, or operate outdoor equipment and cables (including but not limited to moving equipment, operating equipment and cables, inserting connectors to or removing connectors from signal ports connected to outdoor facilities, working at heights, and performing outdoor installation) in harsh weather conditions such as lightning, rain, snow, and level 6 or stronger wind.
- After installing the equipment, remove idle packing materials such as cartons, foam, plastics, and cable ties from the equipment area.
- In the case of a fire, immediately leave the building or the equipment area, and turn on the fire alarm bell or make an emergency call. Do not enter the building on fire in any case.
- Do not scrawl, damage, or block any warning label on the equipment.
- Tighten the screws to the specified torque using tools when installing the equipment.
- Understand the components and functioning of a grid-tied PV power system and relevant local standards.
- Repaint any paint scratches caused during equipment transportation or installation in a timely manner. Equipment with scratches cannot be exposed to an outdoor environment for a long period of time.
- Do not open the host panel of the equipment.
- You shall not reverse engineer, decompile, disassemble, adapt, add code to the device software or alter the device software in any other way, research the internal implementation of the device, obtain the device software source code, infringe on Huawei's intellectual property, or disclose any device software performance test results.

## Personal Safety

- If there is a probability of personal injury or equipment damage during operations on the equipment, immediately stop the operations, report the case to the supervisor, and take feasible protective measures.
- Use tools correctly to avoid hurting people or damaging the equipment.
- Do not touch the energized equipment, as the enclosure is hot.

## 1.2 Personnel Requirements

- Personnel who plan to install or maintain Huawei equipment must receive thorough training, understand all necessary safety precautions, and be able to correctly perform all operations.
- Only qualified professionals or trained personnel are allowed to install, operate, and maintain the equipment.
- Only qualified professionals are allowed to remove safety facilities and inspect the equipment.



- Personnel who will operate the equipment, including operators, trained personnel, and professionals, should possess the local national required qualifications in special operations such as high-voltage operations, working at heights, and operations of special equipment.
- Only professionals or authorized personnel are allowed to replace the equipment or components (including software).

 **NOTE**

- Professionals: personnel who are trained or experienced in equipment operations and are clear of the sources and degree of various potential hazards in equipment installation, operation, and maintenance
- Trained personnel: personnel who are technically trained, have required experience, are aware of possible hazards on themselves in certain operations, and are able to take protective measures to minimize the hazards on themselves and other people
- Operators: operation personnel who may come in contact with the equipment, except trained personnel and professionals

## 1.3 Electrical Safety

### Grounding

- For the equipment that needs to be grounded, install the ground cable first when installing the equipment and remove the ground cable last when removing the equipment.
- Do not damage the ground conductor.
- Do not operate the equipment in the absence of a properly installed ground conductor.
- Ensure that the equipment is connected permanently to the protective ground. Before operating the equipment, check its electrical connection to ensure that it is securely grounded.

### General Requirements

---

 **DANGER**

Before connecting cables, ensure that the equipment is intact. Otherwise, electric shocks or fire may occur.

---

- Ensure that all electrical connections comply with local electrical standards.
- Obtain approval from the local electric utility company before using the equipment in grid-tied mode.
- Ensure that the cables you prepared meet local regulations.
- Use dedicated insulated tools when performing high-voltage operations.

## AC and DC Power

---

 **DANGER**

Do not connect or disconnect power cables with power on. Transient contact between the core of the power cable and the conductor will generate electric arcs or sparks, which may cause fire or personal injury.

---

- Before making electrical connections, switch off the disconnecter on the upstream device to cut off the power supply if people may contact energized components.
- Before connecting a power cable, check that the label on the power cable is correct.
- If the equipment has multiple inputs, disconnect all the inputs before operating the equipment.

## Cabling

- When routing cables, ensure that a distance of at least 30 mm exists between the cables and heat-generating components or areas. This prevents damage to the insulation layer of the cables.
- Bind cables of the same type together. When routing cables of different types, ensure that they are at least 30 mm away from each other.
- Ensure that the cables used in a grid-tied PV power system are properly connected and insulated and meet specifications.

## 1.4 Installation Environment Requirements

- Ensure that the equipment is installed in a well ventilated environment.
- To prevent fire due to high temperature, ensure that the ventilation vents or heat dissipation system are not blocked when the equipment is running.
- Do not expose the equipment to flammable or explosive gas or smoke. Do not perform any operation on the equipment in such environments.

## 1.5 Mechanical Safety

### Using Ladders

- Use wooden or fiberglass ladders when you need to perform live working at heights.
- When a step ladder is used, ensure that the pull ropes are secured and the ladder is held firm.
- Before using a ladder, check that it is intact and confirm its load bearing capacity. Do not overload it.
- Ensure that the wider end of the ladder is at the bottom, or protective measures have been taken at the bottom to prevent the ladder from sliding.

- Ensure that the ladder is securely positioned. The recommended angle for a ladder against the floor is 75 degrees, as shown in the following figure. An angle rule can be used to measure the angle.

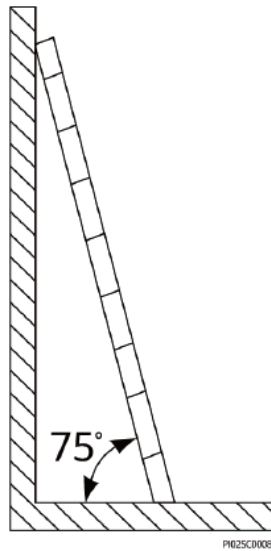

- When climbing a ladder, take the following precautions to reduce risks and ensure safety:
  - Keep your body steady.
  - Do not climb higher than the fourth rung of the ladder from the top.
  - Ensure that your body's center of gravity does not shift outside the legs of the ladder.

## Drilling Holes

When drilling holes into a wall or floor, observe the following safety precautions:

- Wear goggles and protective gloves when drilling holes.
- When drilling holes, protect the equipment from shavings. After drilling, clean up any shavings that have accumulated inside or outside the equipment.

## Moving Heavy Objects

- Be cautious to avoid injury when moving heavy objects.

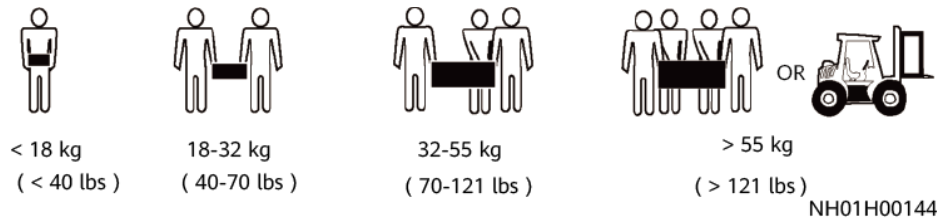

- When moving the equipment by hand, wear protective gloves to prevent injuries.

## 1.6 Commissioning

When the equipment is powered on for the first time, ensure that professional personnel set parameters correctly. Incorrect settings may result in inconsistency with local certification and affect the normal operation of the equipment.

## 1.7 Maintenance and Replacement

---

 **DANGER**

High voltage generated by the equipment during operation may cause an electric shock, which could result in death, serious injury, or serious property damage. Prior to maintenance, power off the equipment and strictly comply with the safety precautions in this document and relevant documents.

- 
- Maintain the equipment with sufficient knowledge of this document and using proper tools and testing equipment.
  - Before maintaining the equipment, power it off and follow the instructions on the delayed discharge label to ensure that the equipment is powered off.
  - Turn off the AC and DC switches of the SUN2000 when maintaining the electric equipment or power distribution equipment connected the SUN2000.
  - Place temporary warning signs or erect fences to prevent unauthorized access to the maintenance site.
  - If the equipment is faulty, contact your dealer.
  - The equipment can be powered on only after all faults are rectified. Failing to do so may escalate faults or damage the equipment.

# 2 Overview

---

## 2.1 Product Introduction

### Function

The SUN2000 is a three-phase grid-tied PV string inverter that converts the DC power generated by PV strings into AC power and feeds the power into the power grid.

### Models

This document involves the following product models:

- SUN2000-12KTL-M5
- SUN2000-15KTL-M5
- SUN2000-17KTL-M5
- SUN2000-20KTL-M5
- SUN2000-25KTL-M5
- SUN2000-15KTL-ZHM5
- SUN2000-17KTL-ZHM5
- SUN2000-20KTL-ZHM5
- SUN2000-25KTL-ZHM5

**Figure 2-1** Model description (SUN2000-15KTL-ZHM5 is used as an example)

**SUN2000-15KTL-ZHM5**

1                      2                      3                      4                      5

**Table 2-1** Model description

No.	Meaning	Value
1	Series name	SUN2000: three-phase grid-tied PV string inverter
2	Power level	<ul style="list-style-type: none"> <li>• 12K: The rated power is 12 kW.</li> <li>• 15K: The rated power is 15 kW.</li> <li>• 17K: The rated power is 17 kW.</li> <li>• 20K: The rated power is 20 kW.</li> <li>• 25K: The rated power is 25 kW.</li> </ul>
3	Topology	TL: transformerless
4	Sales region	ZH: China
5	Product code	M5: product series with an input voltage level of 1100 V DC

## Supported Power Grids

Power grid types supported by the SUN2000 include TN-S, TN-C, TN-C-S, TT, and IT.

**Figure 2-2** Supported power grids

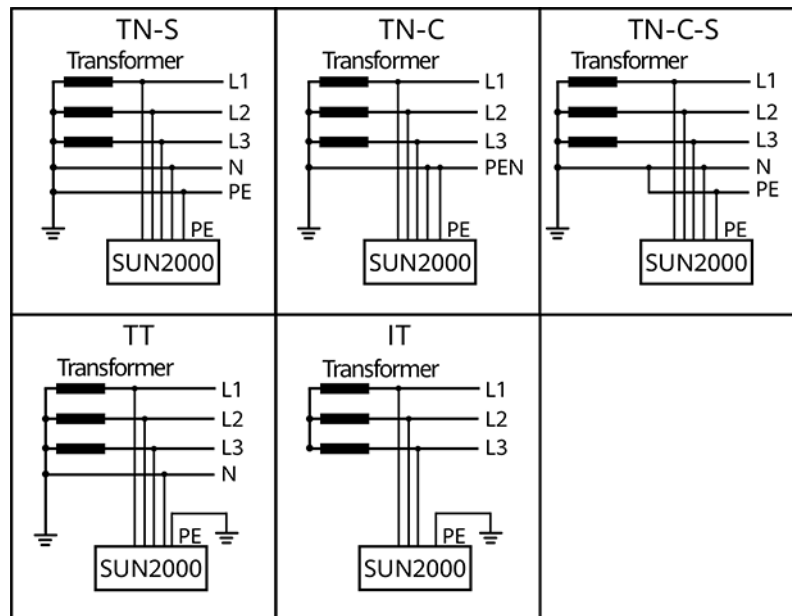

IS01S10001

 NOTE

- In a TT power grid, the N-PE voltage should be lower than 30 V.
- In an IT power grid, you need to set **isolation settings** to **input not grounded, with a transformer**.

## Networking Application

The SUN2000 applies to residential rooftop grid-tied systems and small-sized ground grid-tied PV plants. Typically, a grid-tied system consists of PV strings, grid-tied inverters, AC switches, and power distribution units.

**Figure 2-3** Networking application (single inverter)

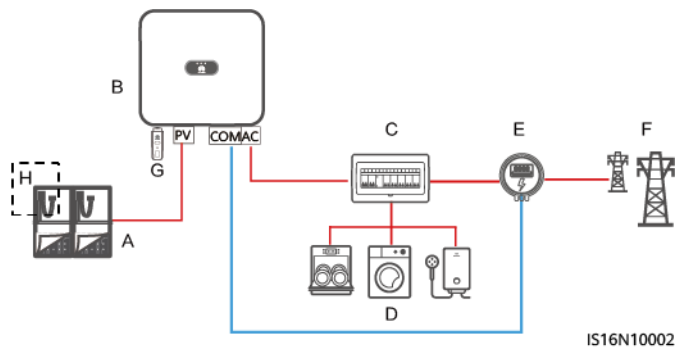

(A) PV string

(B) SUN2000

(C) AC power  
distribution unit

(D) Load

(E) Power meter

(F) Power grid

(G) Smart Dongle

(H) Optimizer

## 2.2 Appearance

Figure 2-4 Appearance

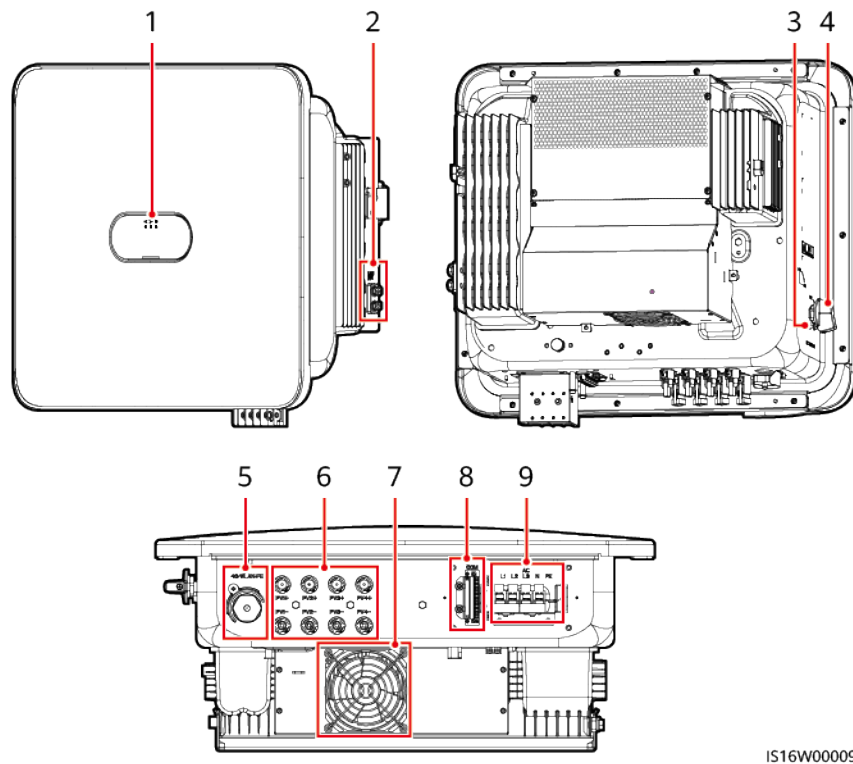

IS16W00009

- (1) LED indicators
- (2) Ground screws
- (3) DC switch locking screw hole<sup>[1]</sup>
- (4) DC switch (DC SWITCH)
- (5) Smart Dongle port (4G/WLAN-FE)
- (6) DC input terminals (PV1–PV4)
- (7) Fan
- (8) Communication port (COM)
- (9) AC output ports (AC)

Note [1]: For models used in Australia, the DC switch locking screw needs to be installed according to the local standard to secure the DC switch (DC SWITCH) and prevent incorrect startup. The DC switch locking screw is delivered with the device.



Table 2-2 LED indicator description

Category	Status		Meaning
Running indication	LED1	LED2	N/A
	Steady green	Steady green	The SUN2000 is operating in grid-tied mode.

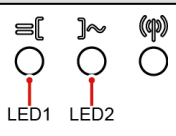
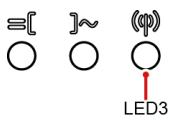

Category	Status			Meaning
 <p>LED1 LED2</p>	Blinking green at long intervals (on for 1s and then off for 1s)	Off		The DC is on and the AC is off.
	Blinking green at long intervals (on for 1s and then off for 1s)	Blinking green at long intervals (on for 1s and then off for 1s)		The DC is on, the AC is on, and the SUN2000 is not exporting power to the power grid.
	Off	Blinking green at long intervals (on for 1s and then off for 1s)		The DC is off and the AC is on.
	Off	Off		Both the DC and AC are off.
	Blinking red at short intervals (on for 0.2s and then off for 0.2s)	N/A		There is a DC environmental alarm, such as an alarm indicating that High String Input Voltage, String Reverse Connection, or Low Insulation Resistance.
	N/A	Blinking red at short intervals (on for 0.2s and then off for 0.2s)		There is an AC environmental alarm, such as an alarm indicating Grid Undervoltage, Grid Overvoltage, Grid Overfrequency, or Grid Underfrequency.
	Steady red	Steady red		Fault
Communication indication  <p>LED3</p>	<b>LED3</b>			N/A
	Blinking green at short intervals (on for 0.2s and then off for 0.2s)			Communication is in progress. (When a mobile phone is connected to the SUN2000, the indicator first indicates that the phone is connected to the SUN2000: blinks green at long intervals.)
	Blinking green at long intervals (on for 1s and then off for 1s)			The mobile phone is connected to the SUN2000.
	Off			There is no communication.
Device replacement indication	<b>LED1</b>	<b>LED2</b>	<b>LED3</b>	N/A
	Steady red	Steady red	Steady red	The SUN2000 hardware is faulty. The SUN2000 needs to be replaced.

## 2.3 Label Description

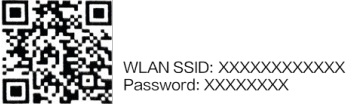
Symbol	Name	Meaning
	Grounding label	Indicates the position for connecting the protective earthing (PE) cable.
	Inverter serial number (SN) label	Indicates the product SN.
	QR code label for inverter Wi-Fi connection	Scan the QR code to connect to the SUN2000 inverter Wi-Fi.

## 2.4 Working Principles

### 2.4.1 Working Modes

The SUN2000 can work in Standby, Operating, or Shutdown mode.

Figure 2-5 Working modes

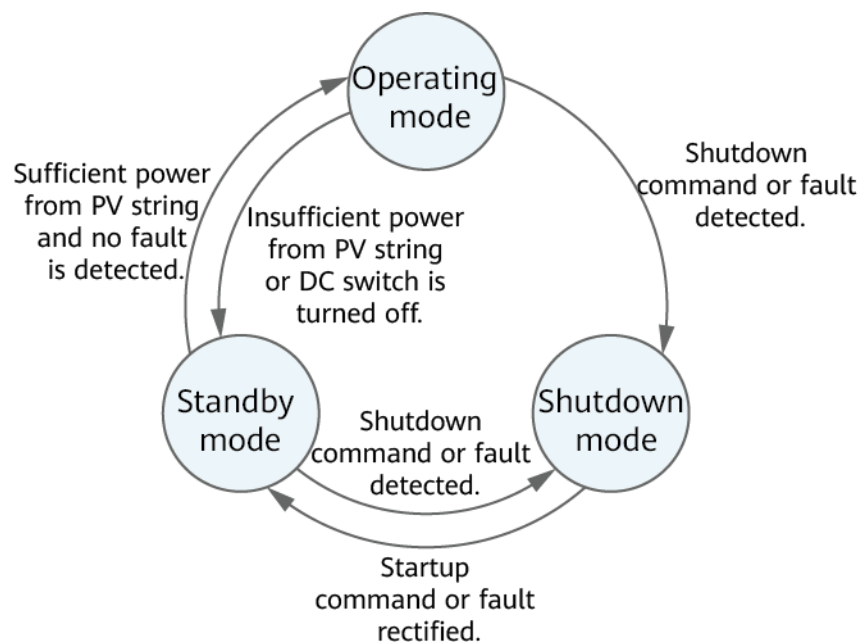

IS07500001

**Table 2-3** Working mode description

Working Mode	Description
Standby	The SUN2000 enters Standby mode when the external environment does not meet the operating requirements. In Standby mode: <ul style="list-style-type: none"> <li>• The SUN2000 continuously performs status check and enters the Operating mode once the operating requirements are met.</li> <li>• The SUN2000 enters Shutdown mode after detecting a shutdown command or a fault after startup.</li> </ul>
Operating	In Operating mode: <ul style="list-style-type: none"> <li>• The SUN2000 converts DC power from PV strings into AC power and feeds the power to the power grid.</li> <li>• The SUN2000 tracks the maximum power point to maximize the PV string output.</li> <li>• If the SUN2000 detects a fault or a shutdown command, it enters the Shutdown mode.</li> <li>• The SUN2000 enters Standby mode after detecting that the PV string output power is not suitable for connecting to the power grid for generating power.</li> </ul>
Shutdown	<ul style="list-style-type: none"> <li>• In Standby or Operating mode, the SUN2000 enters Shutdown mode after detecting a fault or shutdown command.</li> <li>• In Shutdown mode, the SUN2000 enters Standby mode after detecting a startup command or that the fault is rectified.</li> </ul>

## 2.4.2 Circuit Diagram

The inverter connects to four PV strings and tracks the maximum power point of the PV strings through two maximum power point tracking (MPPT) circuits. It also converts DC power into three-phase AC power through an inverter circuit. Surge protection is supported on both the DC and AC sides.

**Figure 2-6** Conceptual diagram

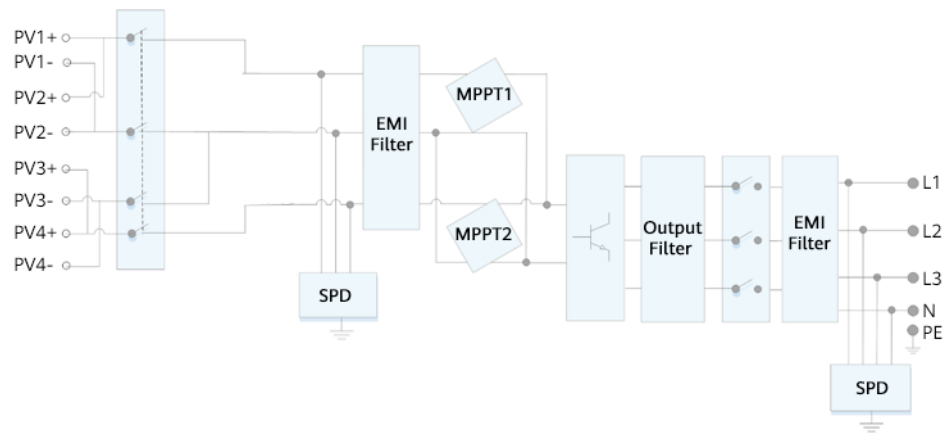

# 3 SUN2000 Storage

---

The following requirements should be met if the SUN2000 is not put into use directly:

- Do not unpack the SUN2000.
- Keep the storage temperature at  $-40^{\circ}\text{C}$  to  $+70^{\circ}\text{C}$  and the humidity at 5%–95% RH.
- Store the SUN2000 in a clean and dry place and protect it from dust and water vapor corrosion.
- A maximum of six SUN2000s can be stacked. To avoid personal injury or device damage, stack SUN2000s with caution to prevent them from falling over.
- During the storage period, check the SUN2000 periodically (recommended: every three months). If any rodent bites are found on the packing materials, replace the packing materials immediately.
- If the SUN2000 has been stored for more than two years, it must be checked and tested by professionals before being put into use.

# 4 Installation

---

## 4.1 Checking Before Installation

### Outer Packing Materials

Before unpacking the inverter, check the outer packing materials for damage, such as holes and cracks, and check the inverter model. If any damage is found or the inverter model is not what you requested, do not unpack the package and contact your supplier as soon as possible.

 **NOTE**

You are advised to remove the packing materials within 24 hours before installing the inverter.









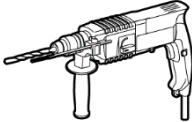
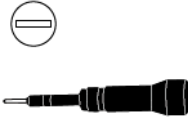

### Package Contents



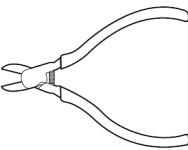
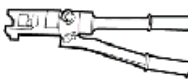
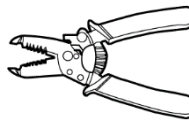
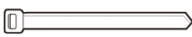

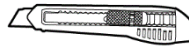

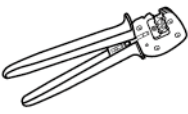

After unpacking the inverter, check that the contents are intact and complete. If any damage is found or any component is missing, contact your supplier.

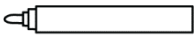
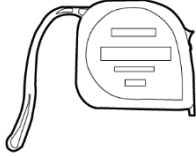
 **NOTE**

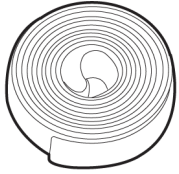
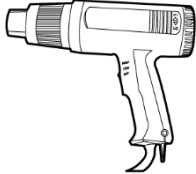
For details about the number of contents, see the *Packing List* in the packing case.

## 4.2 Tools

Type	Tool			
Installation Tools	 Hammer drill Drill bit: $\Phi 8$ mm and $\Phi 6$ mm	 Flat-head insulated torque screwdriver	 Phillips insulated torque screwdriver	 Hex insulated torque screwdriver
	 Insulated torque socket wrench	 Diagonal pliers	 Hydraulic pliers	 Wire stripper
	 Cable tie	 Removal wrench Model: PV-MS-HZ Open-end Wrench; manufacturer: Staubli	 Rubber mallet	 Utility knife
	 Cable cutter	 Crimping tool Model: PV-CZM-22100/19100; manufacturer: Staubli	 Multimeter DC voltage measurement range $\geq 1100$ V DC	 Vacuum cleaner

Type	Tool			
	 Marker	 Measuring tape	 Bubble or digital level	 Cord end terminal crimper
	 Heat shrink tubing	 Heat gun	-	-
PPE	 Insulated gloves	 Protective gloves	 Dust mask	 Safety shoes
	 Safety goggles	-	-	-

## 4.3 Determining the Installation Position

### 4.3.1 Environment Requirements

#### Basic Requirements

- The inverter is protected to IP66 and can be installed indoors or outdoors.
- Do not install the inverter in an easily accessible place because its enclosure and heat sinks generate high temperature during operation.
- Do not install the inverter in noise-sensitive areas.
- Do not install the inverter in areas with flammable or explosive materials.
- Do not install the inverter in a place within children's reach.



- Do not install the inverter outdoors in salt areas because it will be corroded there and may cause fire. A salt area refers to a region within 500 m of the coast or prone to sea breeze. Regions prone to sea breeze vary with weather conditions (such as typhoons and monsoons) or terrains (such as dams and hills).
- The inverter should be installed in a well-ventilated environment to ensure good heat dissipation.
- You are advised to install the inverter in a sheltered area, or with an awning over it.

## Mounting Structure Requirements

- The mounting structure where the inverter is installed must be fireproof.
- Do not install the inverter on flammable building materials.
- The inverter is heavy. Ensure that the installation surface is solid enough to bear the weight.
- In residential areas, do not install the inverter on drywalls or walls made of similar materials which have a weak sound insulation performance because the noise generated by the inverter is noticeable.

## 4.3.2 Space Requirements

### Installation Angle Requirements

The inverter can be wall-mounted or support-mounted. The installation angle requirements are as follows:

- Install the inverter vertically or at a maximum back tilt of 15 degrees to facilitate heat dissipation.
- Do not install the inverter at forward tilted, excessive back tilted, side tilted, horizontal, or upside down positions.

Figure 4-1 Installation angle

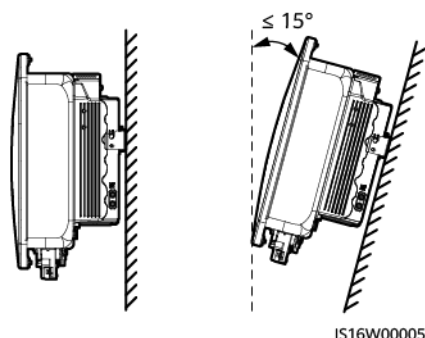

### Clearance Requirements

- Reserve enough clearance around the inverter to ensure sufficient space for installation and heat dissipation.

Figure 4-2 Clearance

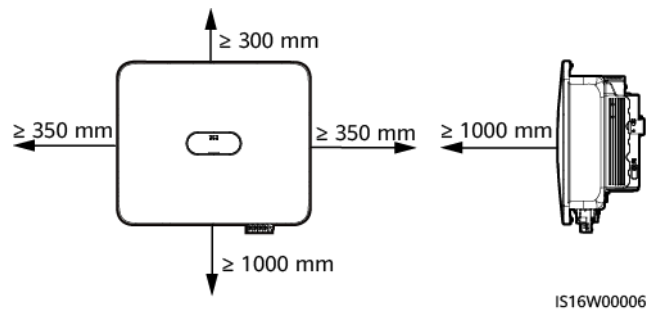

- When installing multiple inverters, install them in horizontal mode if sufficient space is available and install them in triangle mode if no sufficient space is available. Stacked installation is not recommended.

Figure 4-3 Horizontal installation (recommended)

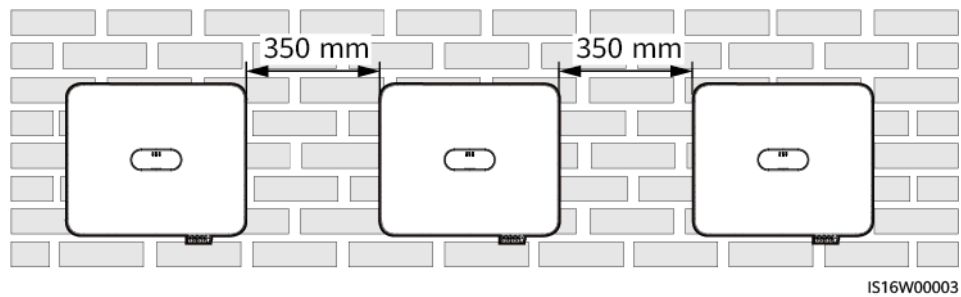
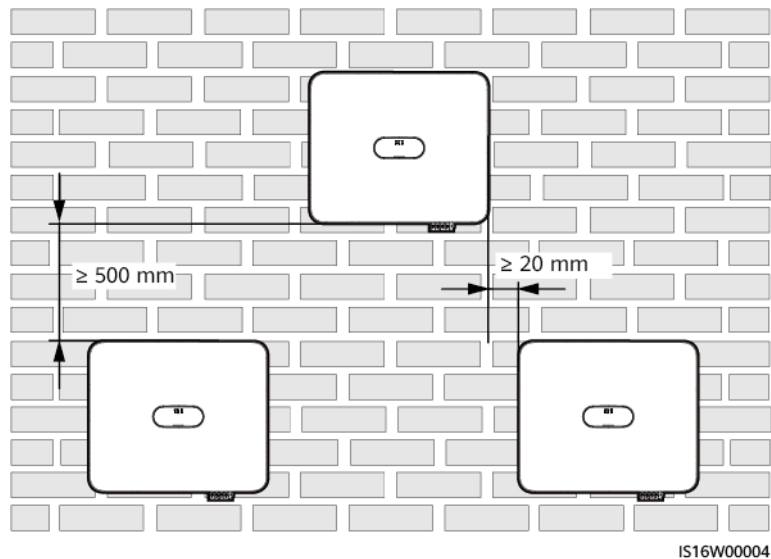

Figure 4-4 Triangle installation (recommended)



## 4.4 Moving an Inverter

### Procedure

- Step 1** Two persons are required to move the inverter with one person on both sides. Lift the inverter from the packing case and move it to the specified installation position.

---

 **CAUTION**

- Move the inverter with care to prevent device damage and personal injury.
  - Do not hold the wiring terminals and ports at the bottom. Do not place the inverter with the wiring terminals and ports touching the ground or other supporting surface.
  - When you need to temporarily place the inverter on the ground, use protection material such as foam and paper underneath to prevent damage to its enclosure.
- 

----End

## 4.5 Installing an Inverter

### Installation Precautions

---

 **DANGER**

Avoid drilling holes into the water pipes or power cables buried in the wall.

---

---

**NOTICE**

- To avoid inhaling dust and to prevent dust from falling into your eyes, ensure that safety goggles and a dust mask are worn when drilling holes.
  - Use a vacuum cleaner to clean up dust in and around the holes, and measure the spacing. If the holes are inaccurately positioned, drill the holes again.
  - Level the top of the expansion sleeve with the concrete wall after removing the bolt, spring washer, and flat washer. Otherwise, the mounting bracket will not be securely installed on the concrete wall.
  - Loosen the nuts, flat washers, and spring washers of the two expansion bolts below.
- 

 **NOTE**

- M6x60 expansion bolts are delivered with the inverter. If the length and quantity of the bolts do not meet installation requirements, prepare M6 stainless steel expansion bolts by yourself.
- The expansion bolts delivered with the inverter are mainly used for solid concrete walls. For other types of walls, prepare bolts by yourself and ensure that the wall meets the load bearing requirements of the inverter.
- For support-mounting, prepare M6 stainless bolt assemblies (including flat washers, spring washers, and M6 bolts) with appropriate lengths as well as corresponding flat washers and nuts based on the support specifications.

**Figure 4-5** Mounting bracket dimensions

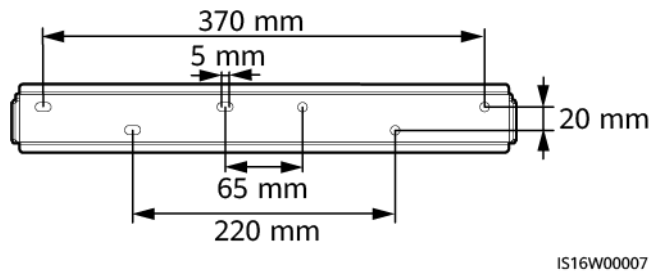

**Table 4-1** Installation modes

Installation Mode	Screw Specifications	Description
Wall-mounting	M6x60 stainless steel expansion bolt	Delivered with the product
Support-mounting	M6 bolt assembly	Prepared by the customer

**Figure 4-6** Expansion bolt composition

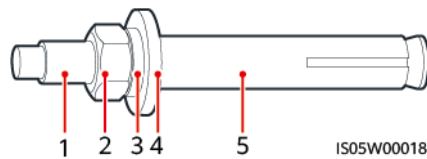

- (1) Bolt
- (2) Nut
- (3) Spring washer
- (4) Flat washer
- (5) Expansion sleeve

## Procedure

**Step 1** Install the mounting bracket.

**Step 2** Mount the inverter on the mounting bracket and install screws.

Figure 4-7 Installing an Inverter

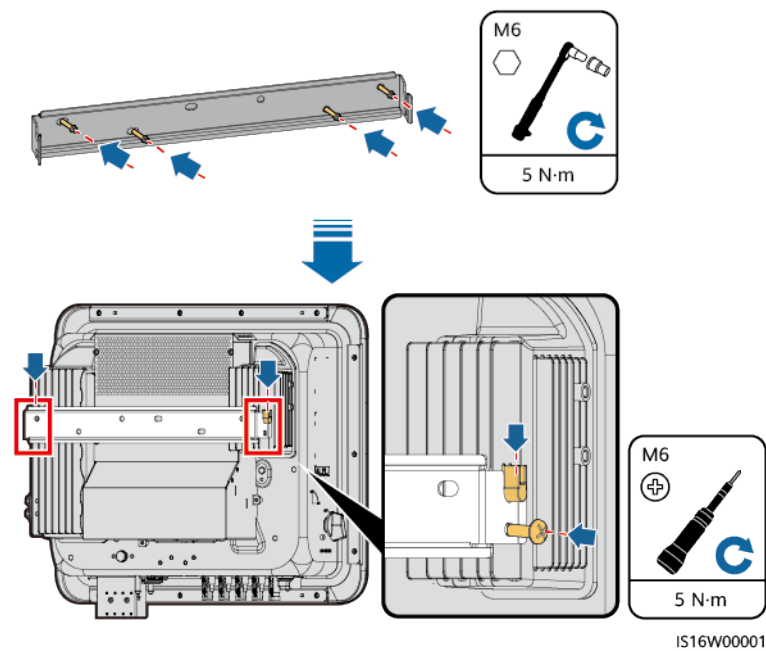

**Step 3** (Optional) Install the locking screw for the DC switch.

Figure 4-8 Installing the locking screw for the DC switch

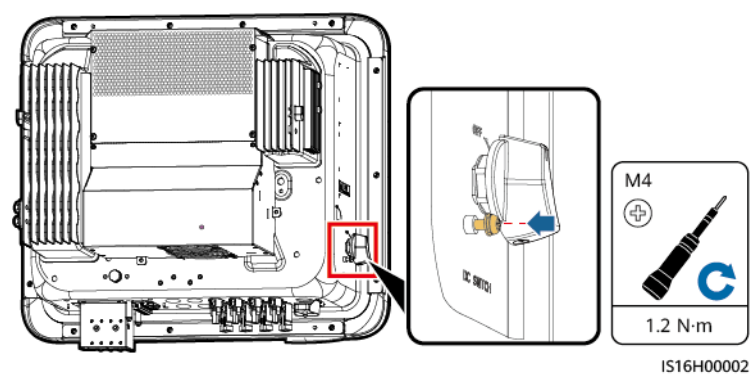

----End

## 4.6 (Optional) Installing a Junction Box

### NOTICE

If you do not connect cables immediately after securing the inverter, install a junction box. Otherwise, the protection level of the inverter will be affected.

**Step 1** Align the pin holes at both ends of the junction box with the positioning pins on the inverter enclosure to ensure that the screw holes on the junction box are aligned.

**Figure 4-9** Aligning positioning pins

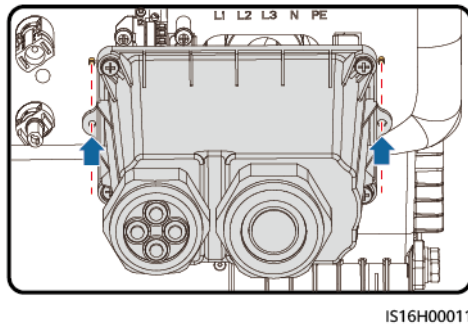

**Step 2** Install the junction box.

**Figure 4-10** Installing a junction box

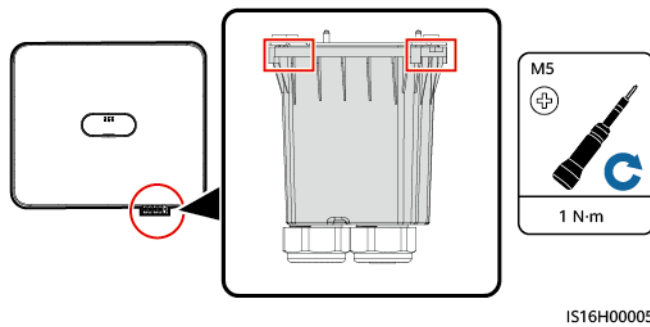

----End

# 5 Electrical Connections

---

## 5.1 Precautions

---

 **DANGER**

When exposed to sunlight, the PV arrays supply DC voltage to the SUN2000. Before connecting cables, ensure that the two DC switches on the SUN2000 are OFF. Otherwise, the high voltage of the SUN2000 may result in electric shocks.

---

---

 **WARNING**

- The equipment damage caused by incorrect cable connections is beyond the warranty scope.
  - Only certified electrician can perform electrical terminations.
  - Wear proper PPE at all time when terminating cables.
  - To prevent poor cable connection due to overstress, it is recommended that the cables be bent and reserved, and then connected to the appropriate ports.
- 

 **NOTE**

The cable colors shown in the electrical connection diagrams provided in this chapter are for reference only. Select cables in accordance with local cable specifications (green-and-yellow cables are only used for grounding).

## 5.2 Preparing Cables

**Figure 5-1** SUN2000 cable connections (Components in the dashed boxes are optional.)

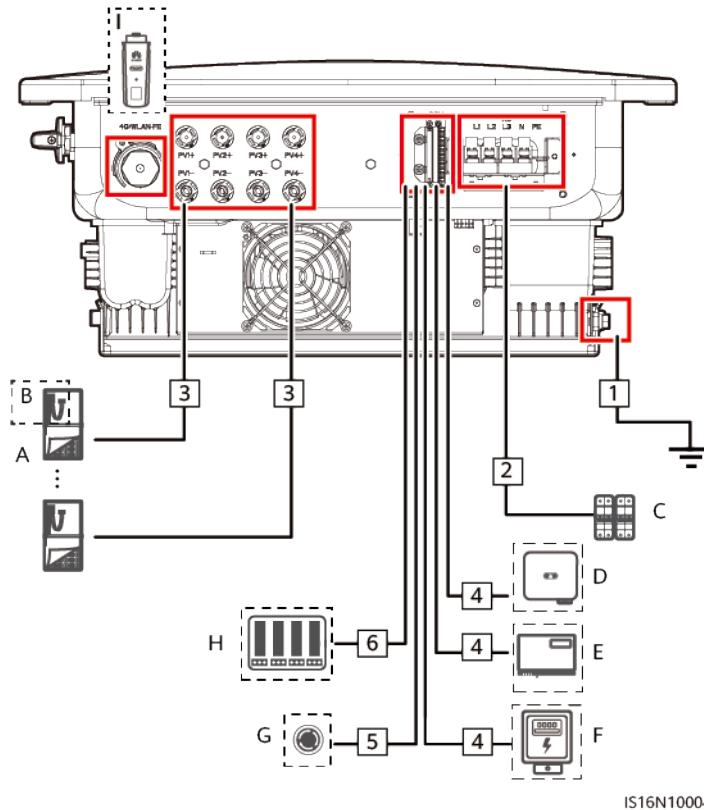

**Table 5-1** Component description

No.	Component	Description	Source
A	PV module	<ul style="list-style-type: none"> <li>A PV string consists of PV modules connected in series.</li> <li>The inverter supports the input from four PV strings.</li> </ul>	Prepared by the customer
B	Smart PV optimizer	Supported optimizer models: <ul style="list-style-type: none"> <li>SUN2000-600W-P</li> <li>SUN2000-450W-P</li> <li>SUN2000-450W-P2</li> </ul>	Purchased from the Company



No.	Component	Description	Source
C	AC switch	To ensure that the inverter can be safely disconnected from the power grid when an exception occurs, connect an AC switch to the AC side of the inverter. Select an appropriate AC switch in accordance with local industry standards and regulations. Huawei recommends the following switch specifications: Recommended: three-phase AC circuit breaker, rated voltage $\geq$ 415 V AC, rated current: <ul style="list-style-type: none"> <li>• 12KTL-20KTL: 40 A</li> <li>• 25KTL: 50 A or 63 A</li> </ul>	Prepared by the customer
D	SUN2000	Select a proper model as required.	Purchased from the Company
E	SmartLogger	Select a proper model as required.	Purchased from the Company
F	Power meter <sup>[1]</sup>	Recommended models: DTSU666-H, DTSU666-HW, and YDS60-80	Purchased from the Company
G	Rapid shutdown switch	Select a proper model as required.	Prepared by the customer
H	Power grid scheduling device	Select the devices that meet the power grid scheduling requirements.	Provided by the local power grid company
I	Smart Dongle <sup>[2]</sup>	Supported models: <ul style="list-style-type: none"> <li>• WLAN-FE Smart Dongle: SDongleA-05</li> <li>• 4G Smart Dongle: SDongleA-03, SDongleB-06</li> </ul>	Purchased from the Company
<p>Note [1]: For details about meter operations, see <i>DTSU666-HW Smart Power Sensor Quick Guide</i>, <i>DTSU666-H 100 A and 250 A Smart Power Sensor User Manual</i>, and <i>YDS60-80 Smart Power Sensor Quick Guide</i>.</p> <p>Note [2]: For details about how to use the WLAN-FE Smart Dongle SDongleA-05, see <i>SDongleA-05 Smart Dongle Quick Guide (WLAN-FE)</i>. For details about how to use the 4G Smart Dongle SDongleA-03, see <i>SDongleA-03 Quick Guide (4G)</i>. For details about how to use the Smart Dongle SDongleB-06, see <i>SDongleB-06 Smart Dongle Quick Guide (4G)</i>. You can obtain the quick guides at <a href="https://support.huawei.com/enterprise">https://support.huawei.com/enterprise</a> by searching for the Smart Dongle model.</p>			

**Table 5-2** Cable description

No.	Name	Type	Conductor Cross-Sectional Area	Outer Diameter
1	PE cable	Single-core outdoor copper cable	12KTL: $\geq 6 \text{ mm}^2$ 15KTL-25KTL: $\geq 10 \text{ mm}^2$	-
2	AC output power cable	Outdoor copper cable	12KTL: $6\text{--}16 \text{ mm}^2$ 15KTL-25KTL: $10\text{--}16 \text{ mm}^2$	11-26 mm
3	DC input power cable	Common outdoor PV cable	$4\text{--}6 \text{ mm}^2$	5.5-9 mm
4	(Optional) RS485 communications cable	Two-core outdoor shielded twisted pair cable	$0.2\text{--}1 \text{ mm}^2$ (recommended: $0.5 \text{ mm}^2$ )	4-11 mm
5	(Optional) Signal cable to the rapid shutdown switch			
6	(Optional) Grid scheduling signal cable			

 **NOTE**

- The minimum cable diameter must meet local standards.
- The factors that affect cable selection include the rated current, cable type, routing mode, ambient temperature, and maximum expected line loss.

## 5.3 Connecting the Ground Cable

### Precautions

 **DANGER**

- Ensure that the PE cable is securely connected. Otherwise, electric shocks may occur.
- Do not connect the neutral wire to the enclosure as a PE cable. Otherwise, electric shocks may occur.

 NOTE

- The PE point at the AC output port is used only as a PE equipotential point, and cannot substitute for the PE point on the enclosure.
- It is recommended that silicone grease or paint be used around the ground terminal after the PE cable is connected.

## Additional Information

The inverter provides the grounding detection function. This function is used to check whether the inverter is properly grounded before the inverter starts, or check whether the inverter ground cable is disconnected when the inverter is running. This function is used to check whether the inverter is properly grounded under limited conditions. To ensure the safe operation of the inverter, properly ground the inverter according to the connection requirements of the PE cable. For some power grid types, if the output side of the inverter is connected to an isolation transformer, ensure that the inverter is properly grounded and then disable **Grounding abnormal shutdown** so that the inverter can run properly.

- According to IEC 62109, to ensure the safe operation of the inverter in the case of PE cable damage or disconnection, properly connect the PE cable of the inverter and ensure that it meets at least one of the following requirements before the grounding detection function becomes invalid.
  - If the PE terminal of the AC connector is not connected, the PE cable on the enclosure must be a single-core outdoor copper cable with a cross-sectional area of at least 10 mm<sup>2</sup>.
  - Use cables with the same diameter as the AC output power cable and ground the PE terminal on the AC connector and the ground screws on the enclosure.
- In some countries and regions, the inverter must have additional ground cables. In this case, use cables with the same diameter as the AC output power cable and ground the PE terminal on the AC connector and the ground screws on the enclosure.

## Procedure

### Step 1 Crimp an OT terminal.

---

**NOTICE**

- Avoid scratching the core wire when stripping a cable.
  - The cavity formed after the conductor crimp strip of the OT terminal is crimped must wrap the core wires completely. The core wires must contact the OT terminal closely.
  - Wrap the wire crimping area with heat-shrink tubing or insulation tape. The heat-shrink tubing is used as an example.
  - Use a heat gun carefully to avoid heat damage to the equipment.
-

**Figure 5-2** Crimping an OT terminal

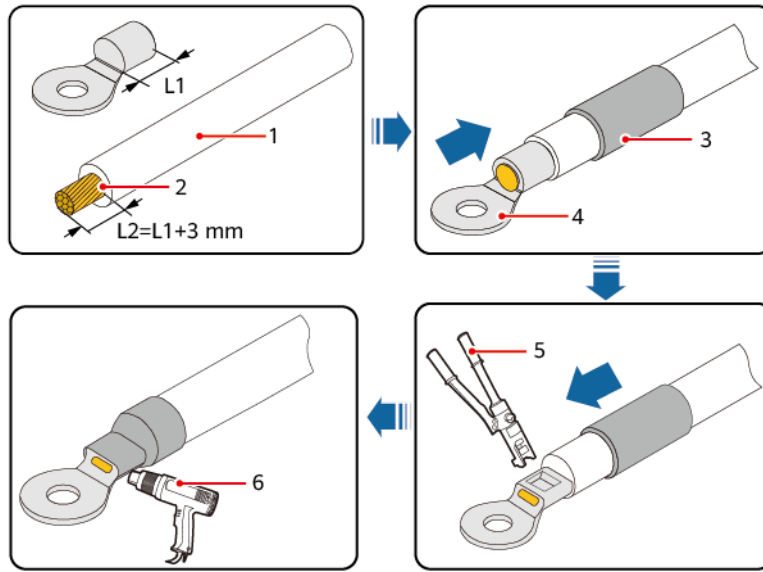

IS06200001

- |                 |                   |                        |
|-----------------|-------------------|------------------------|
| (1) Cable       | (2) Core wire     | (3) Heat-shrink tubing |
| (4) OT terminal | (5) Crimping tool | (6) Heat gun           |

**Step 2** Connect the PE cable.

**Figure 5-3** Connecting a PE cable

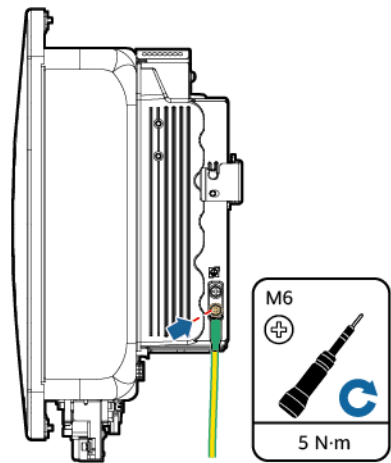

IS16150001

----End

## 5.4 Installing DC Input Power Cables

### Precautions

---

** DANGER**

- Before connecting the DC input power cable, ensure that the DC voltage is within the safe range (lower than 60 V DC) and that the inverter DC SWITCH is OFF. Failing to do so may result in electric shocks.
  - When the inverter is operating, it is not allowed to work on the DC input power cables, such as connecting or disconnecting a PV string or a PV module in a PV string. Otherwise, electric shocks may occur.
  - If no PV string connects to a DC input terminal of the inverter, do not remove the watertight cap from the DC input terminals. Otherwise, the protection level of the inverter will be affected.
- 

---

** WARNING**

Ensure that the following conditions are met. Otherwise, the inverter may be damaged, or even a fire may occur.

- PV modules connected in series in each PV string are of the same specifications.
  - The maximum open-circuit voltage of each PV string must be less than or equal to 1100 V DC.
  - The maximum short-circuit current of each PV string must be less than or equal to 20 A.
  - PV strings must be connected in the correct polarity. The positive and negative terminals of a PV string connect to the corresponding positive and negative DC input terminals of the inverter, respectively.
  - If the DC input power cables are reversely connected, do not operate DC SWITCH or the positive and negative connectors immediately. Wait until the night when solar irradiance declines and the PV string current drops to below 0.5 A. Then set DC SWITCH to OFF, remove the positive and negative connectors, and connect the DC input power cables correctly.
-

### NOTICE

- The output of the PV strings connected to the inverter cannot be grounded. Ensure that the PV output is well insulated to ground.
- PV modules and optimizers in the PV strings connecting to the same MPPT must be of the same model and quantity.
- If power cables are not properly installed or routed during the installation of PV strings and the inverter, the positive or negative terminals of PV strings may be short-circuited to ground. In this case, an AC or DC short circuit may occur and damage the inverter. The resulting device damage is not covered under any warranty.

## Terminal Description

Figure 5-4 DC input terminals

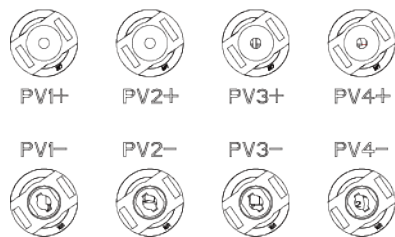

## Procedure

### WARNING

Before inserting the positive and negative connectors into the positive and negative DC input terminals of the inverter, ensure that DC SWITCH is set to OFF.

---

**NOTICE**

- Cables with high rigidity, such as armored cables, are not recommended as DC input power cables, because poor contact may be caused by the bending of the cables.
- Before assembling DC connectors, label the cable polarity correctly to ensure correct cable connections.
- After crimping the positive and negative metal terminals, pull back the DC input power cables to ensure that they are connected securely.
- Insert the crimped metal terminals of the positive and negative power cables into the appropriate positive and negative connectors. Then pull back the DC input power cables to ensure that they are connected securely.
- If a DC input power cable is reversely connected and DC SWITCH is set to ON, do not operate on DC SWITCH or the positive and negative connectors immediately. Otherwise, the device may be damaged. The resulting device damage is not covered under any warranty. Wait until the night when solar irradiance declines and the PV string current drops to below 0.5 A. Then set DC SWITCH to OFF, remove the positive and negative connectors, and connect DC input power cable correctly.

---

 **NOTE**

- The DC voltage measurement range of the multimeter must be at least 1100 V. If the voltage is a negative value, the DC input polarity is incorrect. Correct the cable connection. If the voltage is greater than 1100 V DC, too many PV modules are connected in the same string. Re-configure the PV modules.
- If PV strings are configured with optimizers, check the cable polarity by referring to the *Smart PV Optimizer Quick Guide*.

**Step 1** Install the DC input power cables.

---

 **CAUTION**

Use the Staubli MC4 positive and negative metal terminals and DC connectors delivered with the inverter. Using incompatible positive and negative metal terminals and DC connectors may result in serious consequences. The resulting device damage is not covered under any warranty.

---

**Figure 5-5** Assembling DC connectors

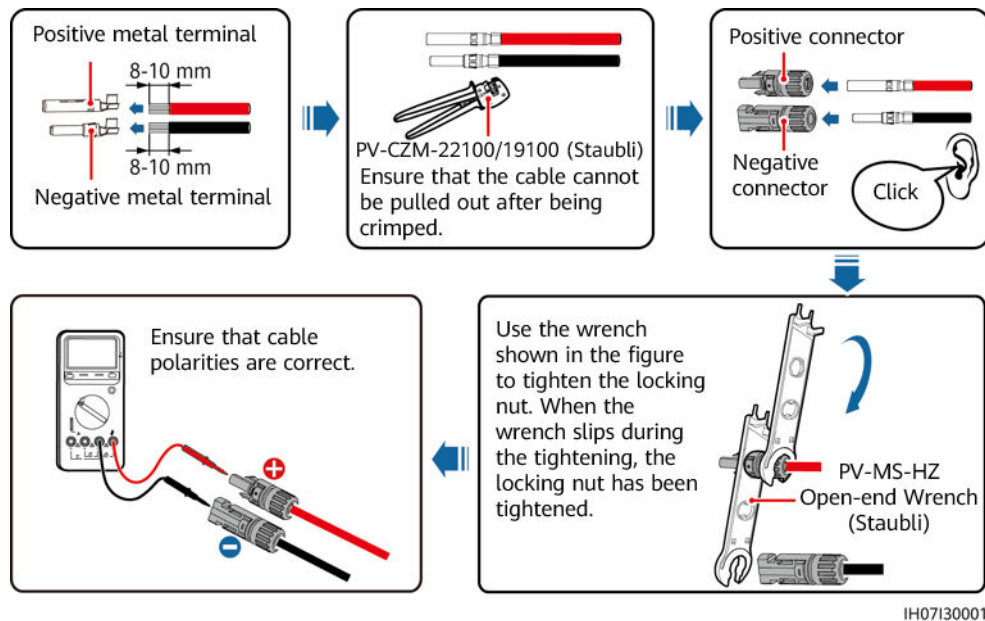

----End

## Removing DC Connectors

### WARNING

Before removing the positive and negative connectors, ensure that DC SWITCH is set to OFF and that the current is less than 0.5 A.

To remove the positive and negative connectors from the inverter, insert an open-end wrench into the bayonet and press the wrench with force. Then remove the DC connectors with caution.

**Figure 5-6** Removing a DC Connector

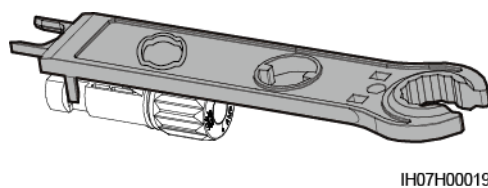

## 5.5 Installing AC Output Power Cables and Signal Cables

### Precautions

It is recommended that a three-phase AC switch be installed on the AC side of the inverter. To ensure that the inverter can safely disconnect itself from the power



grid when an exception occurs, select a proper overcurrent protection device in compliance with local power distribution regulations.

---

 **WARNING**

- Do not connect loads between the inverter and the AC switch that directly connects to the inverter. Otherwise, the switch may trip by mistake.
  - If an AC switch is used with specifications beyond local standards, regulations, or Huawei's recommendations, the switch may fail to turn off in a timely manner in case of exceptions, causing serious faults.
- 

---

 **CAUTION**

Each inverter must be equipped with an AC output switch. Multiple inverters cannot connect to the same AC output switch.

---

The inverter is installed with an integrated monitoring unit for the residual current. When the inverter detects that the residual current exceeds the permitted value, it disconnects from the power grid quickly.

---

**NOTICE**

- If the external AC switch has residual current protection, its rated leakage tripping current must be greater than or equal to 300 mA.
  - If multiple inverters are connected to the master leakage protection device through their AC switches, the rated leakage tripping current of the device must be greater than or equal to the number of inverters x 300 mA.
  - The AC switch cannot be a knife switch.
- 

## COM Port Pin Definitions

---

**NOTICE**

- When laying out signal cables, separate them from power cables and keep them away from strong interference sources to avoid strong communication interference.
  - Ensure that the protection layer of a signal cable is inside the connector, that excess core wires are cut off from the protection layer, that the exposed core wires are totally inserted into the cable hole, and that the cable is connected securely.
-

**Figure 5-7** Signal definitions

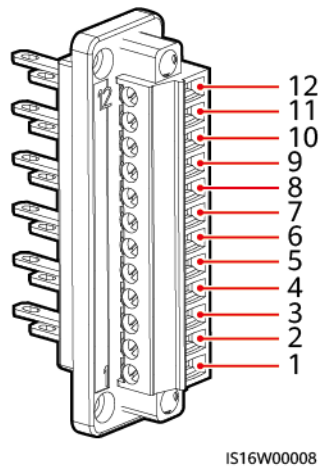

**Table 5-3** Signal definitions

Pin	Definition	Function	Description
1	GND	Ripple control	GND port for the DIN1 to DIN5 signals
2	DIN1		Dry contact for grid scheduling
3	DIN2		
4	DIN3		
5	DIN4		
6	DIN5	Rapid shutdown signal+	For the rapid shutdown DI signal or connecting to the signal cable of an NS protective device
7	GND	GND	-
8	-	-	-
9	485A1	RS485A1 differential signal+	For inverter cascading or connecting to the RS485 signal port of a SmartLogger
10	485B1	RS485B1 differential signal-	
11	485A2	RS485A2 differential signal+	Connecting to the RS485 signal port of a power meter
12	485B2	RS485B2 differential signal-	

## Procedure



**Step 1** Route the cables through the junction box and prepare cable terminals.

### NOTICE

The cable stripping length must meet the requirements. Otherwise, the airtightness and waterproof performance of the device may be affected.

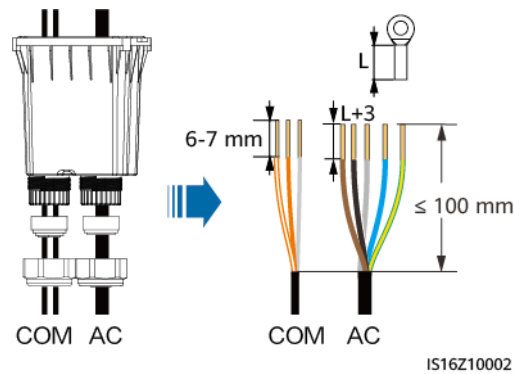
**Figure 5-8** Routing cables

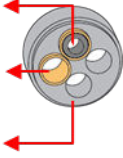

Inner Diameter	Rubber Plug
15 mm	
22 mm	
26 mm	
6 mm	
8.6 mm	
11 mm	

**Step 2** Install AC output power cables and signal cables. (The following uses the RS485 signal cables as an example. For details about other signal cables, see the signal definitions of communications ports.)

**Figure 5-9** Installing AC output power cables and signal cables

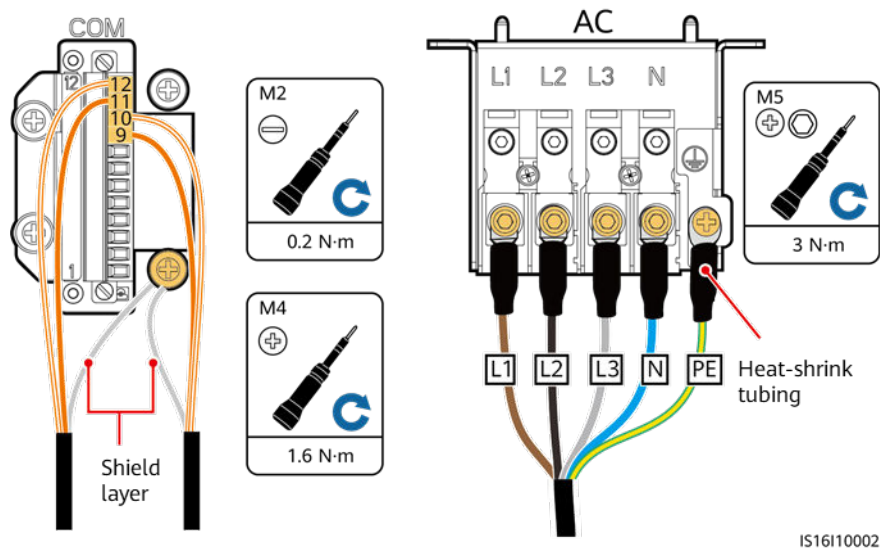

IS16110002

- Step 3** Align the pin holes at both ends of the junction box with the positioning pins on the inverter enclosure to ensure that the screw holes on the junction box are aligned.

**Figure 5-10** Aligning positioning pins

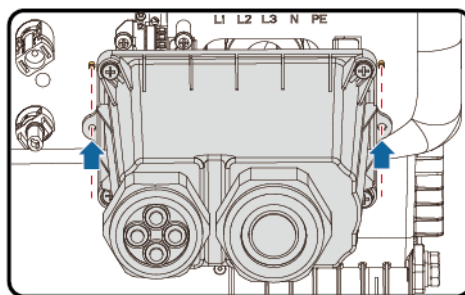

IS16H00011

- Step 4** Install the junction box, seal the unused cable holes in the rubber plugs with waterproof plugs, and tighten the locking caps.

**Figure 5-11** Installing a junction box

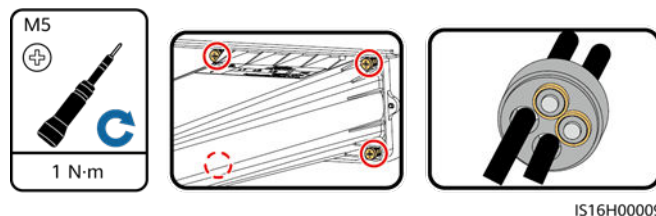

IS16H00009

----End

## 5.6 (Optional) Installing the Smart Dongle and Anti-theft Components

 NOTE

If the Smart Dongle is used, you need to install anti-theft components after installing the Smart Dongle.

**Step 1** Install the Smart Dongle. For details, see the *Smart Dongle Quick Guide*.

**Step 2** Install the anti-theft components.

**Figure 5-12** Installing the Smart Dongle anti-theft components

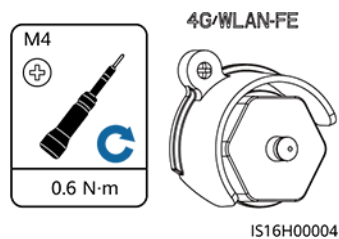

----End

# 6 Commissioning

## 6.1 Check Before Power-On

**Table 6-1** Installation checklist

No.	Check Item	Acceptance Criteria
1	SUN2000 installation	The SUN2000 is installed correctly, securely, and reliably.
2	Smart Dongle	The Smart Dongle is installed correctly and securely.
3	Cable layout	Cables are routed properly as required by the customer.
4	Cable tie	Cable ties are secured evenly and no burr exists.
5	Grounding	The ground cable is connected correctly, securely, and reliably.
6	Turn off the switches	The <b>DC SWITCH</b> and all the switches connected to the SUN2000 are set to <b>OFF</b> .
7	Cable connections	The AC output power cable, DC input power cable, and signal cable are connected correctly, securely, and reliably.
8	Unused terminals and ports	Unused terminals and ports are locked by watertight caps.
9	Installation environment	The installation space is proper, and the installation environment is clean and tidy, without foreign matter.

## 6.2 Powering On the System

### Precautions

#### NOTICE

If the DC power supply is connected but the AC power supply is disconnected, the inverter will report a **Grid Failure** alarm. The inverter can start properly only after the power grid recovers.

### Procedure

- Step 1** At the AC switch between the inverter and the power grid, use a multimeter to measure the grid voltage and ensure that the voltage is within the allowed operating voltage range of the inverter. If the voltage is not in the allowed range, check the circuits.
- Step 2** Turn on the AC switch between the inverter and the power grid.
- Step 3** Turn on the DC switch (if any) between the PV strings and the inverter.
- Step 4** (Optional) Remove the locking screw next to the DC SWITCH on the inverter.
- Step 5** Set the DC SWITCH to ON.
- Step 6** Observe the LED indicators to check the status of the inverter.

**Table 6-2** Indicator description

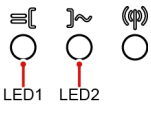
Category	Status		Description
Running indication 	<b>LED1</b>	<b>LED2</b>	-
	Steady green	Steady green	The inverter is operating in grid-tied mode.
	Blinking green slowly (on for 1s and off for 1s)	Off	The DC is on and the AC is off.
	Blinking green slowly (on for 1s and off for 1s)	Blinking green slowly (on for 1s and off for 1s)	Both the DC and AC are on, but the inverter is yet to connect to the power grid.
	Off	Blinking green slowly (on for 1s and off for 1s)	The DC is off and the AC is on.

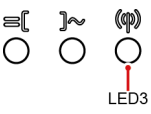
Category	Status			Description
	Off	Off		Both the DC and AC are off.
	Blinking red fast (on for 0.2s and off for 0.2s)	-		DC environment alarm For example, the input voltage of the PV string is high, the PV string is reversely connected, or the insulation resistance is low.
	-	Blinking red fast (on for 0.2s and off for 0.2s)		AC environment alarm For example, grid undervoltage/overvoltage or grid overfrequency/underfrequency occurred.
	Steady red	Steady red		Faulty
Communica tion indication 	<b>LED3</b>			-
	Blinking green fast (on for 0.2s and off for 0.2s)			Communication is in progress. (When a mobile phone is connected to the inverter, the indicator blinks green slowly, indicating that the phone is connected to the inverter.)
	Blinking green slowly (on for 1s and off for 1s)			Mobile phone access
	Off			No communication
Device replacement indicator	<b>LED1</b>	<b>LED2</b>	<b>LED3</b>	-
	Steady red	Steady red	Steady red	The inverter hardware is faulty. The inverter needs to be replaced.

**Step 7** (Optional) Observe the Smart Dongle LED indicator to check the status of the Smart Dongle.

- WLAN-FE Smart Dongle



**Figure 6-1** WLAN-FE Smart Dongle

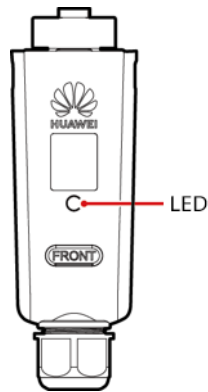

**Table 6-3** Indicator description

LED Indicator	Status	Remarks	Description
-	Off	Normal	The Smart Dongle is not secured or not powered on.
Yellow (blinking green and red simultaneously)	Steady on		The Smart Dongle is secured and powered on.
Red	Blinking fast (on for 0.2s and off for 0.2s)		The parameters for connecting to the router are to be set.
Red	Steady on	Abnormal	The Smart Dongle is faulty and needs to be replaced.
Blinking red and green alternately	Blinking slowly (on for 1s and off for 1s)	Abnormal	No communication with the inverter: <ul style="list-style-type: none"> <li>- Remove and then insert the Smart Dongle.</li> <li>- Check whether the inverter matches the Smart Dongle.</li> <li>- Connect the Smart Dongle to another inverter.</li> </ul> Check whether the Smart Dongle is faulty or the USB port of the inverter is faulty.
Green	Blinking slowly (on for 0.5s and off for 0.5s)	Normal	Connecting to the router

LED Indicator	Status	Remarks	Description
Green	Steady on		The management system is successfully connected.
Green	Blinking fast (on for 0.2s and off for 0.2s)		The inverter is communicating with the management system through the Smart Dongle.

- 4G Smart Dongle

**Table 6-4** Indicator description

LED Indicator	Status	Remarks	Description
-	Off	Normal	The Smart Dongle is not secured or not powered on.
Yellow (blinking green and red simultaneously)	Steady on	Normal	The Smart Dongle is secured and powered on.
Green	The blinking interval is 2s. The indicator is on for 0.1s and off for 1.9s.	Normal	Dialing (lasts for less than 1 minute)
		Abnormal	If the duration is longer than 1 minute, the 4G parameter settings are incorrect. Re-configure the parameters.
	Blinking slowly (on for 1s and off for 1s)	Normal	The dialup is successful (lasts for less than 30s).
		Abnormal	If the duration is longer than 30s, the management system parameters are incorrectly set. Re-configure the parameters.
	Steady on	Normal	The management system is successfully connected.
Blinking fast (on for 0.2s and off for 0.2s)	The inverter is communicating with the management system through the Smart Dongle.		
Red	Steady on	Abnormal	The Smart Dongle is faulty and needs to be replaced.

LED Indicator	Status	Remarks	Description
	Blinking fast (on for 0.2s and off for 0.2s)		The Smart Dongle has no SIM card or the SIM card is in poor contact. Check whether the SIM card has been installed or is in good contact. If not, install a SIM card or remove and re-insert the SIM card.
	Blinking slowly (on for 1s and off for 1s)		The Smart Dongle fails to be connected to a management system because the SIM card has poor or no reception, or has run out of mobile data. If the Smart Dongle is reliably connected, check the SIM card connectivity through the app. If you have poor or no reception, contact the carrier. Check whether the tariff and mobile data plan of the SIM card are adequate. If not, ensure sufficient balance in the SIM card or purchase a data package.
Blinking red and green alternately	Blinking slowly (on for 1s and off for 1s)		No communication with the inverter: <ul style="list-style-type: none"> <li>- Remove and then insert the Smart Dongle.</li> <li>- Check whether the inverter matches the Smart Dongle.</li> <li>- Connect the Smart Dongle to another inverter.</li> </ul> Check whether the Smart Dongle is faulty or the USB port of the inverter is faulty.

----End

# 7 Man-Machine Interactions

## 7.1 App Commissioning

### 7.1.1 Downloading the FusionSolar App

- Method 1: Access <https://solar.huawei.com> using the mobile phone browser and download the latest installation package.

Figure 7-1 Download Mode

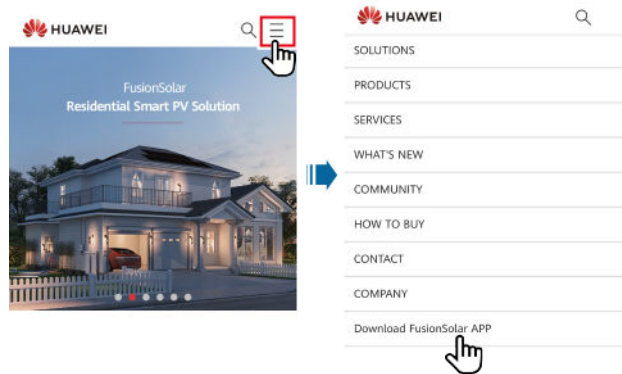

- Method 2: Search for FusionSolar on Huawei AppGallery and download the latest installation package.
- Method 3: Scan the following QR code and download the latest installation package.

Figure 7-2 QR code



## 7.1.2 (Optional) Registering an Installer Account

### NOTE

- If you have an installer account, skip this step.
- You can register an account only using a mobile phone only in China.
- The mobile number or email address used for registration is the user name for logging in to the FusionSolar App.

Create the first installer account and create a domain named after the company name.

Figure 7-3 Creating the first installer account

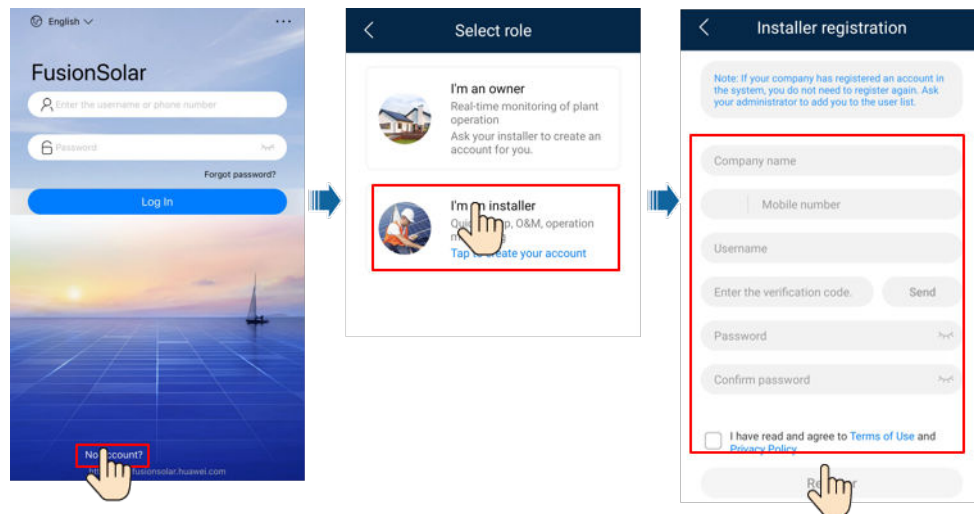

### NOTICE

To create multiple installer accounts for a company, log in to the FusionSolar App and tap **Add User** to create an installer account.

Figure 7-4 Creating multiple installer accounts for the same company

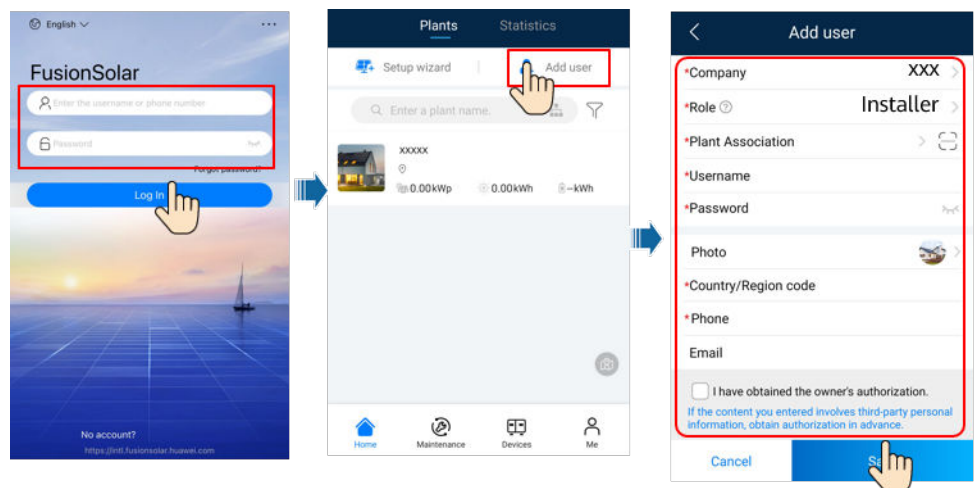

### 7.1.3 Creating a PV Plant and a User

Figure 7-5 Creating a PV plant and a user

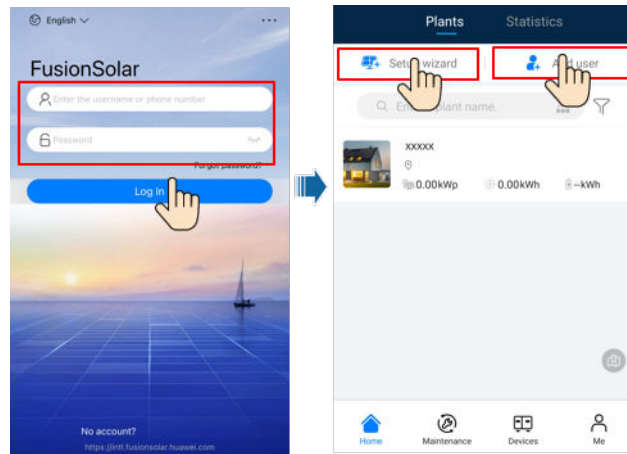

#### NOTE

- In the quick settings, the grid code is set to N/A by default (automatic startup is not supported). Set the grid code based on the area where the PV plant is located.
- For details about how to use the site deployment wizard, see [FusionSolar App Quick Guide](#). You can scan the QR code to download the quick guide.



### 7.1.4 (Optional) Setting the Physical Layout of the Smart PV Optimizers

For details about the optimizer physical layout, see [FusionSolar App Quick Guide](#) or online help of the management system.



### 7.1.5 Detecting Optimizer Disconnection

Log in to the FusionSolar app, choose **Device Commissioning > Maintenance > Optimizer disconnection detection**, tap the detection button to detect the optimizer disconnection, and rectify the fault based on the detection result.

**Figure 7-6 Detect optimizer disconnection**

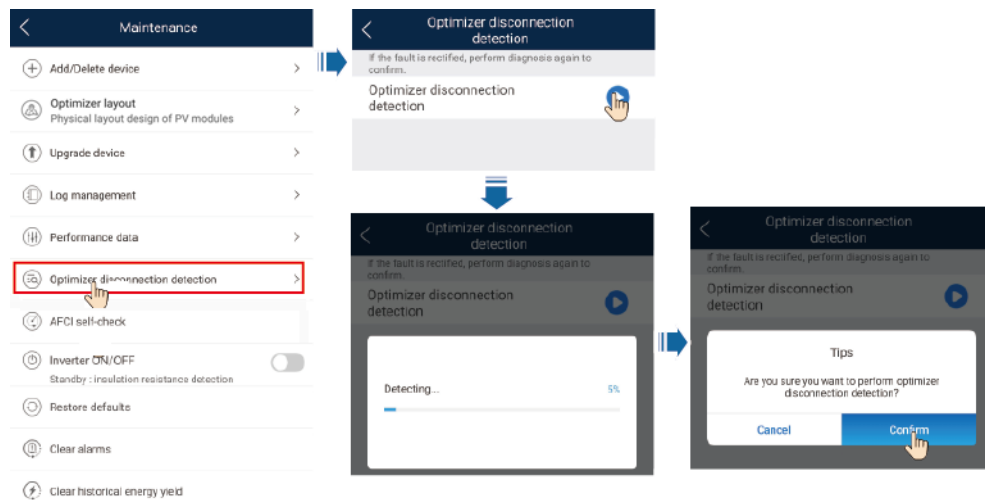

## 7.2 Parameters Settings

Go to the **Device Commissioning** screen and set SUN2000 parameters. For details about entering the **Device Commissioning** screen, see [B Device Commissioning](#).

To set more parameters, tap **Settings**. For details about the parameters, see the [FusionSolar App and SUN2000 App User Manual](#). You can also scan the QR code to obtain the document.



### 7.2.1 Energy Control

#### 7.2.1.1 Grid-tied Point Control

##### Function

Limits or reduces the output power of the PV power system to ensure that the output power is within the power deviation limit.

##### Procedure

**Step 1** On the home screen, choose **Power adjustment > Grid-tied point control**.

**Figure 7-7** Grid-tied point control

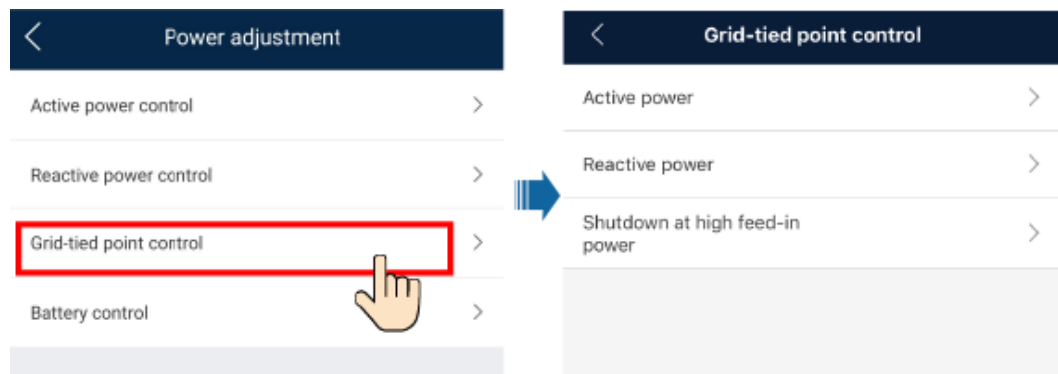

**Table 7-1** Grid-tied point control

Parameter Name			Description
Active power	Unlimited	-	If this parameter is set to <b>Unlimited</b> , the output power of the SUN2000 is not limited and the SUN2000 can connect to the power grid at the rated power.
	Grid connection with zero power	Closed-loop controller	<ul style="list-style-type: none"> <li>If multiple SUN2000s are cascaded, set this parameter to <b>SDongle/SmartLogger</b>.</li> <li>If there is only one SUN2000, set this parameter to <b>Inverter</b>.</li> </ul>
		Limitation mode	<b>Total power</b> indicates export limitation of the total power at the grid-tied point.
		Power adjustment period	Specifies the shortest interval for a single anti-backfeeding adjustment.
		Power control hysteresis	Specifies the dead zone for adjusting the SUN2000 output power. If the power fluctuation is within the power control hysteresis, the power is not adjusted.
		Active power output limit for fail-safe	Specifies the derating value of the SUN2000 active power by percentage. If the Smart Dongle does not detect any meter data or the communication between the Smart Dongle and the SUN2000 is disconnected, the Smart Dongle delivers the derating value of the SUN2000 active power by percentage.



Parameter Name		Description
	Communication disconnection fail-safe	In the SUN2000 anti-backfeeding scenario, if this parameter is set to <b>Enable</b> , the SUN2000 will derate according to the active power derating percentage when the communication between the SUN2000 and the Smart Dongle is disconnected for a period longer than <b>Communication disconnection detection time</b> .
	Communication disconnection detection time	Specifies the time for determining the communication disconnection between the SUN2000 and the Dongle.  This parameter is displayed when <b>Communication disconnection fail-safe</b> is set to <b>Enable</b> .
Grid connection with limited power (kW)	Closed-loop controller	<ul style="list-style-type: none"> <li>• If multiple SUN2000s are cascaded, set this parameter to <b>SDongle/SmartLogger</b>.</li> <li>• If there is only one SUN2000, set this parameter to <b>Inverter</b>.</li> </ul>
	Limitation mode	<b>Total power</b> indicates export limitation of the total power at the grid-tied point.
	Maximum grid feed-in power	Specifies the maximum active power transmitted from the grid-tied point to the power grid.
	Power adjustment period	Specifies the shortest interval for a single anti-backfeeding adjustment.
	Power control hysteresis	Specifies the dead zone for adjusting the SUN2000 output power. If the power fluctuation is within the power control hysteresis, the power is not adjusted.
	Active power output limit for fail-safe	Specifies the derating value of the SUN2000 active power by percentage. If the Smart Dongle does not detect any meter data or the communication between the Smart Dongle and the SUN2000 is disconnected, the Smart Dongle delivers the derating value of the SUN2000 active power by percentage.

Parameter Name		Description
	Communication disconnection fail-safe	In the SUN2000 anti-backfeeding scenario, if this parameter is set to <b>Enable</b> , the SUN2000 will derate according to the active power derating percentage when the communication between the SUN2000 and the Smart Dongle is disconnected for a period longer than <b>Communication disconnection detection time</b> .
	Communication disconnection detection time	Specifies the time for determining the communication disconnection between the SUN2000 and the Dongle. This parameter is displayed when <b>Communication disconnection fail-safe</b> is set to <b>Enable</b> .
Grid connection with limited power (%)	Closed-loop controller	<ul style="list-style-type: none"> <li>• If multiple SUN2000s are cascaded, set this parameter to <b>SDongle/SmartLogger</b>.</li> <li>• If there is only one SUN2000, set this parameter to <b>Inverter</b>.</li> </ul>
	Limitation mode	<b>Total power</b> indicates export limitation of the total power at the grid-tied point.
	PV plant capacity	Specifies the total maximum active power in the SUN2000 cascading scenario.
	Maximum grid feed-in power	Specifies the percentage of the maximum active power of the grid-tied point to the PV plant capacity.
	Power adjustment period	Specifies the shortest interval for a single anti-backfeeding adjustment.
	Power control hysteresis	Specifies the dead zone for adjusting the SUN2000 output power. If the power fluctuation is within the power control hysteresis, the power is not adjusted.

Parameter Name		Description
	Active power output limit for fail-safe	Specifies the derating value of the SUN2000 active power by percentage. If the Smart Dongle does not detect any meter data or the communication between the Smart Dongle and the SUN2000 is disconnected, the Smart Dongle delivers the derating value of the SUN2000 active power by percentage.
	Communication disconnection fail-safe	In the SUN2000 anti-backfeeding scenario, if this parameter is set to <b>Enable</b> , the SUN2000 will derate according to the active power derating percentage when the communication between the SUN2000 and the Smart Dongle is disconnected for a period longer than <b>Communication disconnection detection time</b> .
	Communication disconnection detection time	Specifies the time for determining the communication disconnection between the SUN2000 and the Dongle.  This parameter is displayed when <b>Communication disconnection fail-safe</b> is set to <b>Enable</b> .
Shutdown at high feed-in power <sup>a</sup>	Shutdown at high feed-in power	<ul style="list-style-type: none"> <li>The default value is <b>Disable</b>.</li> <li>If this parameter is set to <b>Enable</b>, the inverter shuts down for protection when the grid-connection point power exceeds the threshold and remains in this condition for the specified time threshold.</li> </ul>
	Upper feed-in power threshold for inverter shutdown (kW)	<ul style="list-style-type: none"> <li>The default value is <b>0</b>. This parameter specifies the power threshold of the grid-connection point for triggering inverter shutdown.</li> </ul>

Parameter Name		Description
	High feed-in power duration threshold for triggering inverter shutdown (s)	<p>The default value is <b>20</b>. This parameter specifies the duration threshold of high feed-in power for triggering inverter shutdown.</p> <ul style="list-style-type: none"> <li>• When <b>High feed-in power duration threshold for triggering inverter shutdown</b> is set to <b>5</b>, <b>Shutdown at high feed-in power</b> takes precedence.</li> <li>• When <b>High feed-in power duration threshold for triggering inverter shutdown</b> is set to <b>20</b>, <b>Grid connection with limited power</b> takes precedence (when <b>Active power control</b> is set to <b>Grid connection with limited power</b>).</li> </ul>
<p>Note a: This parameter is supported only for the AS4777 grid code.</p>		

 **NOTE**

- The communication disconnection fail-safe function must be used together with grid connection with zero power or grid connection with limited power. If grid connection with zero power or grid connection with limited power is not set, you are advised to disable the communication disconnection fail-safe function. Otherwise, the inverter enters unnecessary output power protection state.
- If grid connection with zero power or grid connection with limited power is disabled, the inverter automatically disables the communication disconnection fail-safe function. If grid connection with zero power or grid connection with limited power is enabled again, you need to manually enable or disable the communication disconnection fail-safe function based on networking requirements.

----End

### 7.2.1.2 Apparent Power Control on the Inverter Output Side

On the home screen, tap **Settings > Power adjustment** to set inverter parameters.

Figure 7-8 Apparent power control

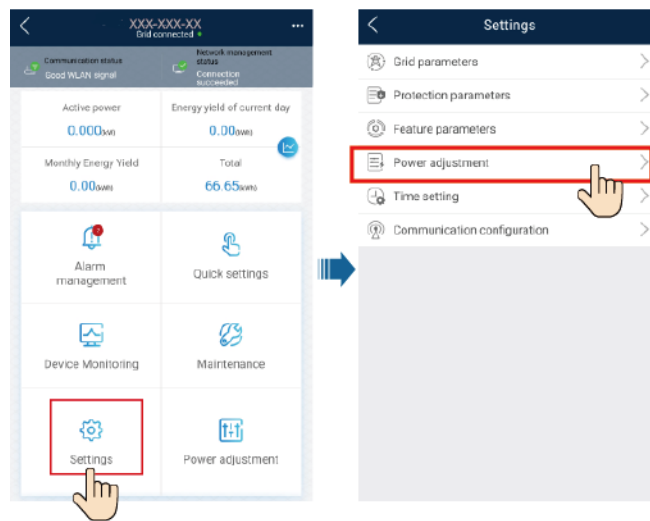

Table 7-2 Apparent power

Parameter	Description	Value Range
Maximum apparent power (kVA)	Specifies the output upper threshold for the maximum apparent power to adapt to the capacity requirements of standard and customized inverters.	[Maximum active power, $S_{max}$ ]
Maximum active power (kW)	Specifies the output upper threshold for the maximum active power to adapt to different market requirements.	[0.1, $P_{max}$ ]

**NOTE**

The lower threshold for the maximum apparent power is the maximum active power. To lower the maximum apparent power, lower the maximum active power first.

## 7.2.2 AFCI

### Function

If PV modules or cables are not properly connected or damaged, electric arcs may occur, which may cause fire. Huawei SUN2000s provide unique arc detection in compliance with UL 1699B-2018 to ensure the safety of users' lives and property.

This function is enabled by default. The SUN2000 automatically detects arc faults. To disable this function, log in to the FusionSolar App, enter the **Device Commissioning** screen, choose **Settings > Feature parameters**, and disable **AFCI**.

 **NOTE**

The AFCI function works only with Huawei optimizers or ordinary PV modules, but does not support third-party optimizers or intelligent PV modules.

## Clearing Alarms

The AFCI function involves the **DC arc fault** alarm.

The SUN2000 has the AFCI alarm automatic clearance mechanism. If an alarm is triggered for less than five times within 24 hours, the SUN2000 automatically clears the alarm. If the alarm is triggered for five times or more within 24 hours, the SUN2000 locks for protection. You need to manually clear the alarm on the SUN2000 so that it can work properly.

You can manually clear the alarm as follows:

- **Method 1:** FusionSolar App

Log in to the FusionSolar App and choose **Me > Device commissioning**. On the **Device commissioning** screen, connect and log in to the SUN2000 that generates the AFCI alarm, tap **Alarm management**, and tap **Clear** on the right of the **DC arc fault** alarm to clear the alarm.

**Figure 7-9** Alarm management

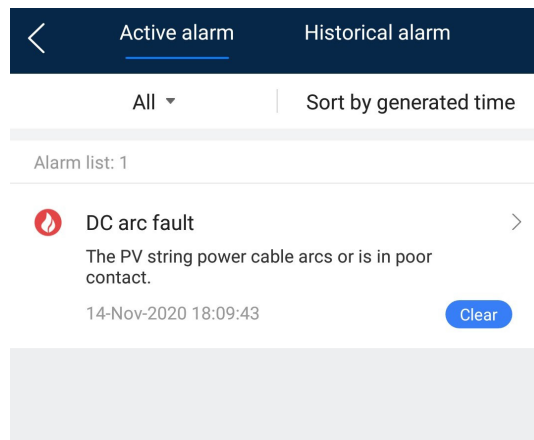

- **Method 2:** FusionSolar Smart PV Management System

Log in to the FusionSolar Smart PV Management System using a non-owner account, choose **Maintenance > Alarm Management**, select the **DC arc fault** alarm, and click **Clear** to clear the alarm.

**Figure 7-10** Clearing alarms

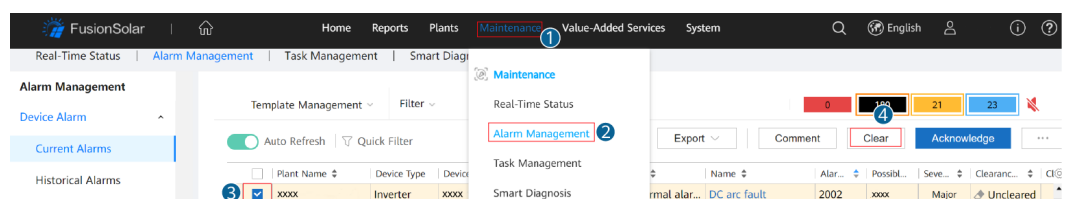

Switch to the owner account with PV plant management rights. On the home page, click the PV plant name to go to the PV plant page, and click **OK** as prompted to clear the alarm.

# 8 Maintenance

---

## 8.1 Powering Off the System

### Precautions

---

 **WARNING**

- After the system is powered off, the inverter is still energized and hot, which may cause electric shocks or burns. Therefore, wait for 5 minutes after power-off and then put on protective gloves to operate the inverter.
  - Power off the system before maintaining optimizers and PV strings. Otherwise, electric shocks may occur when the PV strings are energized.
- 

### Procedure

- Step 1** Send a shutdown command on the app.
- Step 2** Turn off the AC switch between the inverter and the power grid.
- Step 3** Set **DC SWITCH** to **OFF**.
- Step 4** (Optional) Install the locking screw next to **DC SWITCH**.
- Step 5** Turn off the DC switch between the inverter and PV strings.

----End

## 8.2 Routine Maintenance

To ensure that the SUN2000 can operate properly for a long term, you are advised to perform routine maintenance on it as described in this chapter.



 **CAUTION**

Before cleaning the system, connecting cables, and ensuring the grounding reliability, power off the system.

**Table 8-1** Maintenance checklist

Check Item	Check Method	Maintenance Interval
System cleanliness	Check periodically that the heat sinks are free from obstacles and dust.	Once every 6 to 12 months
System operating status	<ul style="list-style-type: none"> <li>• Check that the SUN2000 is not damaged or deformed.</li> <li>• Check that the SUN2000 operates with no abnormal sound.</li> <li>• Check that all SUN2000 parameters are correctly set during operation.</li> </ul>	Once every 6 months
Electrical connection	<ul style="list-style-type: none"> <li>• Check that cables are secured.</li> <li>• Check that cables are intact, and that in particular, the parts touching the metallic surface are not scratched.</li> </ul>	The first inspection is 6 months after the initial commissioning. From then on, the interval can be 6 to 12 months.
Grounding reliability	Check that ground cables are securely connected.	The first inspection is 6 months after the initial commissioning. From then on, the interval can be 6 to 12 months.
Air tightness	Check that all terminals and ports are properly sealed.	Once a year

## 8.3 Troubleshooting

 **NOTE**

Contact your dealer if all failure analysis procedures listed above are completed and the fault still exists.

Alarm severities are defined as follows:

- Major: The inverter is faulty. As a result, the output power decreases or the grid-tied power generation is stopped.
- Minor: Some components are faulty without affecting the grid-tied power generation.

- Warning: The inverter works properly. The output power decreases or some authorization functions fail due to external factors.

**Table 8-2** Common alarms and troubleshooting measures

Alarm ID	Alarm Name	Alarm Severity	Possible Causes	Troubleshooting
2001	High string input voltage	Major	<p>The PV array is not properly configured. Excessive PV modules are connected in series to the PV string, and therefore the PV string open-circuit voltage exceeds the maximum inverter operating voltage.</p> <ul style="list-style-type: none"> <li>• Cause ID 1: PV strings 1 and 2</li> <li>• Cause ID 2: PV strings 3 and 4</li> </ul>	<p>Reduce the number of PV modules connected in series to the PV string until the PV string open-circuit voltage is less than or equal to the maximum inverter operating voltage. After the PV string configuration is corrected, the alarm disappears.</p>
2003	DC arc fault	Major	<p>The PV string power cables arc or are in poor contact.</p> <p>Cause ID 1–4: PV strings 1–4</p>	<p>Check whether the PV string cables arc or are in poor contact.</p>
2011	String reverse connection	Major	<p>The PV string polarity is reversed.</p> <p>Cause ID 1–4: PV strings 1–4</p>	<p>Check whether the PV string is reversely connected to the inverter. If yes, wait until the solar irradiance declines at night and the PV string current drops to below 0.5 A. Then, turn off the DC switch and correct the PV string connection.</p>
2012	String current backfeed	Warning	<p>The number of PV modules connected in series to the PV string is insufficient. As a result, the terminal voltage is lower than that of other strings.</p> <p>Cause ID 1–4: PV strings 1–4</p>	<ol style="list-style-type: none"> <li>1. Check whether the number of PV modules connected in series to the PV string is less than that of other PV strings. If yes, wait until the PV string current drops below 0.5 A, turn off all DC switches, and adjust the number of PV modules in the PV string.</li> <li>2. Check whether the open-circuit voltage of the PV string is abnormal.</li> <li>3. Check whether the PV string is shaded.</li> </ol>

Alarm ID	Alarm Name	Alarm Severity	Possible Causes	Troubleshooting
2021	AFCI self-check failure	Major	Cause ID = 1 The AFCI self-check fails.	Turn off the AC output switch and DC input switch, and then turn them on after 5 minutes. If the alarm persists, contact Huawei technical support.
2031	Phase wire short-circuited to PE	Major	Cause ID = 1 The impedance of the output phase wire to PE is low or the output phase wire is short-circuited to PE.	Check the impedance of the output phase wire to PE, locate the position with low impedance, and rectify the fault.
2032	Grid loss	Major	Cause ID = 1 <ul style="list-style-type: none"> <li>• Power grid outage occurs.</li> <li>• The AC circuit is disconnected or the AC switch is off.</li> </ul>	<ol style="list-style-type: none"> <li>1. The alarm is cleared automatically after the power grid recovers.</li> <li>2. Check whether the AC circuit is disconnected or the AC switch is off.</li> </ol>
2033	Grid undervoltage	Major	Cause ID = 1 The power grid voltage is below the lower threshold or the low-voltage duration has lasted for more than the value specified by LVRT.	<ol style="list-style-type: none"> <li>1. If the alarm occurs occasionally, the power grid may be abnormal temporarily. The inverter automatically recovers after detecting that the power grid becomes normal.</li> <li>2. If the alarm persists, check whether the power grid voltage is within the acceptable range. If not, contact the local power operator. If yes, modify the grid undervoltage protection threshold through the app, SmartLogger, or NMS with the consent of the local power operator.</li> <li>3. If the alarm persists for a long time, check the AC circuit breaker and AC output power cable.</li> </ol>

Alarm ID	Alarm Name	Alarm Severity	Possible Causes	Troubleshooting
2034	Grid overvoltage	Major	<p>Cause ID = 1</p> <p>The power grid voltage exceeds the upper threshold or the high voltage duration has lasted for more than the value specified by HVRT.</p>	<ol style="list-style-type: none"> <li>1. If the alarm occurs occasionally, the power grid may be abnormal temporarily. The inverter automatically recovers after detecting that the power grid becomes normal.</li> <li>2. If the alarm persists, check whether the power grid frequency is within the acceptable range. If not, contact the local power operator. If yes, modify the grid overfrequency protection threshold through the app, SmartLogger, or NMS with the consent of the local power operator.</li> <li>3. Check whether the peak voltage of the power grid is too high. If the alarm persists and lasts for a long time, contact the local power operator.</li> </ol>
2035	Grid volt. Imbalance	Major	<p>Cause ID = 1</p> <p>The difference between power grid phase voltages exceeds the upper threshold.</p>	<ol style="list-style-type: none"> <li>1. If the alarm occurs occasionally, the power grid may be abnormal temporarily. The inverter automatically recovers after detecting that the power grid becomes normal.</li> <li>2. If the alarm persists, check whether the power grid voltage is within the acceptable range. If not, contact the local power operator.</li> <li>3. If the alarm lasts for a long time, check the AC output power cable connection.</li> <li>4. If the AC output power cable is correctly connected, yet the alarm persists and affects the energy yield of the PV plant, contact the local power operator.</li> </ol>

Alarm ID	Alarm Name	Alarm Severity	Possible Causes	Troubleshooting
2036	Grid overfrequency	Major	Cause ID = 1 Power grid exception: The actual power grid frequency is higher than the requirements for the local power grid code.	<ol style="list-style-type: none"> <li>1. If the alarm occurs occasionally, the power grid may be abnormal temporarily. The inverter automatically recovers after detecting that the power grid becomes normal.</li> <li>2. If the alarm persists, check whether the power grid frequency is within the acceptable range. If not, contact the local power operator. If yes, modify the grid overfrequency protection threshold through the app, SmartLogger, or NMS with the consent of the local power operator.</li> </ol>
2037	Grid underfrequency	Major	Cause ID = 1 Power grid exception: The actual power grid frequency is lower than the requirements for the local power grid code.	<ol style="list-style-type: none"> <li>1. If the alarm occurs occasionally, the power grid may be abnormal temporarily. The inverter automatically recovers after detecting that the power grid becomes normal.</li> <li>2. If the alarm persists, check whether the power grid frequency is within the acceptable range. If not, contact the local power operator. If yes, modify the grid underfrequency protection threshold through the app, SmartLogger, or NMS with the consent of the local power operator.</li> </ol>
2038	Unstable grid frequency	Major	Cause ID = 1 Power grid exception: The actual change rate of the power grid frequency does not meet the requirements for the local power grid code.	<ol style="list-style-type: none"> <li>1. If the alarm occurs occasionally, the power grid may be abnormal temporarily. The inverter automatically recovers after detecting that the power grid becomes normal.</li> <li>2. If the alarm persists, check whether the power grid frequency is within the acceptable range. If not, contact the local power operator.</li> </ol>

Alarm ID	Alarm Name	Alarm Severity	Possible Causes	Troubleshooting
2039	Output overcurrent	Major	Cause ID = 1 The power grid voltage drops dramatically or the power grid is short-circuited. As a result, the inverter transient output current exceeds the upper threshold, and protection is triggered.	<ol style="list-style-type: none"><li>1. The inverter monitors its external operating conditions in real time and automatically recovers after the fault is rectified.</li><li>2. If the alarm persists and affects the energy yield of the PV plant, check whether the output is short-circuited. If the fault cannot be rectified, contact your dealer or Huawei technical support.</li></ol>
2040	Output DC component overhigh	Major	Cause ID = 1 The DC component of the inverter output current exceeds the upper threshold.	<ol style="list-style-type: none"><li>1. The inverter monitors its external operating conditions in real time and automatically recovers after the fault is rectified.</li><li>2. If the alarm persists and affects the energy yield of the PV plant, contact your dealer or Huawei technical support.</li></ol>
2051	Abnormal residual current	Major	Cause ID = 1 The insulation impedance of the input side to PE decreases when the inverter is operating.	<ol style="list-style-type: none"><li>1. If the alarm occurs accidentally, the external power cable may be abnormal temporarily. The inverter automatically recovers after the fault is rectified.</li><li>2. If the alarm persists or lasts a long time, check whether the impedance between the PV string and ground is too low.</li></ol>

Alarm ID	Alarm Name	Alarm Severity	Possible Causes	Troubleshooting
2061	Abnormal grounding	Major	Cause ID = 1 <ul style="list-style-type: none"> <li>The neutral wire or PE cable of the inverter is not connected.</li> <li>The output mode set for the inverter is inconsistent with the cable connection mode.</li> </ul>	Power off the inverter (turn off the AC output switch and DC input switch, and wait for a period of time. For details about the wait time, see the description on the device safety warning label), and then perform the following operations: <ol style="list-style-type: none"> <li>Check whether the PE cable for the inverter is connected properly.</li> <li>If the inverter is connected to a TN power grid, check whether the neutral wire is properly connected and whether the voltage of the neutral wire to ground is normal.</li> <li>After the inverter is powered on, check whether the output mode set for the inverter is consistent with the output cable connection mode.</li> </ol>
2062	Low insulation resistance	Major	Cause ID = 1 <ul style="list-style-type: none"> <li>The PV array is short-circuited with PE.</li> <li>The PV string has been in a moist environment for a long time and the circuit is not well insulated to ground.</li> </ul>	<ol style="list-style-type: none"> <li>Check the impedance between the PV string and the PE cable. If a short circuit occurs, rectify the fault.</li> <li>Check whether the PE cable of the inverter is correctly connected.</li> <li>If you have confirmed that the impedance is lower than the specified protection threshold in a cloudy or rainy environment, log in to the app, SmartLogger, or NMS and set <b>Insulation resistance protection threshold</b>.</li> </ol>
2063	Cabinet overtemperature	Minor	Cause ID = 1 <ul style="list-style-type: none"> <li>The inverter is installed in a place with poor ventilation.</li> <li>The ambient temperature exceeds the upper threshold.</li> <li>The inverter is not operating properly.</li> </ul>	<ol style="list-style-type: none"> <li>Check the ventilation and ambient temperature at the inverter installation position.</li> <li>If the ventilation is poor or the ambient temperature exceeds the upper threshold, improve the ventilation and heat dissipation.</li> <li>If both the ventilation and ambient temperature meet requirements yet the alarm persists, contact your dealer or Huawei technical support.</li> </ol>

Alarm ID	Alarm Name	Alarm Severity	Possible Causes	Troubleshooting
2064	Device fault	Major	<p>Cause ID = 1-5, 7-12</p> <p>An unrecoverable fault occurs on a circuit inside the inverter.</p>	<p>Turn off the AC output switch and DC input switch, and then turn them on after 5 minutes. If the alarm persists, contact your dealer or Huawei technical support.</p> <p><b>NOTICE</b> Cause ID = 1: Perform the preceding operations when the PV string current is less than 1 A.</p>
2065	Upgrade failed or version mismatch	Minor	<p>Cause ID = 1-4, 7</p> <p>The upgrade is not completed normally.</p>	<ol style="list-style-type: none"> <li>1. Perform an upgrade again.</li> <li>2. If the upgrade fails several times, contact your dealer or Huawei technical support.</li> </ol>
61440	Faulty monitoring unit	Minor	<p>Cause ID = 1</p> <ul style="list-style-type: none"> <li>• The flash memory is insufficient.</li> <li>• The flash memory has bad sectors.</li> </ul>	<p>Turn off the AC output switch and DC input switch, and then turn them on after 5 minutes. If the alarm persists, replace the monitoring board or contact your dealer or Huawei technical support.</p>
2067	Faulty power collector	Major	<p>Cause ID = 1</p> <p>The power meter is disconnected.</p>	<ol style="list-style-type: none"> <li>1. Check whether the configured power meter model is the same as the actual model.</li> <li>2. Check whether the communications parameters of the power meter are the same as the RS485 configurations of the inverter.</li> <li>3. Check whether the power meter is powered on and whether the RS485 communications cable is connected.</li> </ol>



Alarm ID	Alarm Name	Alarm Severity	Possible Causes	Troubleshooting
2080	Abnormal PV module configuration	Major	<ul style="list-style-type: none"> <li>• Cause ID = 2 The PV string power or the number of optimizers connected in series in a PV string exceeds the upper threshold.</li> <li>• Cause ID = 3 The number of optimizers connected in series in a PV string is less than the lower threshold, the PV string output is reversely connected, or the output of some optimizers in the PV string is reversely connected.</li> <li>• Cause ID = 6 Under the same MPPT, the number of optimizers connected in series in PV strings connected in parallel is different, or the output of some optimizers in PV strings is reversely connected.</li> <li>• Cause ID = 7 The optimizer installation position is changed, or PV strings are</li> </ul>	<p>Check whether the total number of PV modules, number of PV modules in a PV string, and number of PV strings meet requirements and whether the PV module output is reversely connected.</p> <ul style="list-style-type: none"> <li>• Cause ID 2: Check whether the PV string power or the number of PV strings connected in series exceeds the upper threshold.</li> <li>• Cause ID 3:               <ol style="list-style-type: none"> <li>1. Check whether the number of optimizers connected in series in the PV string is below the lower threshold.</li> <li>2. Check whether the PV string output is reversely connected.</li> <li>3. Check whether the PV string output is disconnected.</li> <li>4. Check whether the optimizer output extension cable is correct (positive connector at one end and negative connector at the other).</li> </ol> </li> <li>• Cause ID 6:               <ol style="list-style-type: none"> <li>1. Check whether the number of optimizers connected in series in the PV strings connected in parallel under the same MPPT is the same.</li> <li>2. Check whether the optimizer output extension cable is correct (positive connector at one end and negative connector at the other).</li> </ol> </li> <li>• Cause ID 7: When the sunlight is normal, perform the optimizer search function again.</li> <li>• Cause ID 8: When the sunlight is normal, perform the optimizer search function again.</li> <li>• Cause ID 9: Calculate the PV string voltage based on the number of PV modules in the string and check whether the string voltage exceeds the upper threshold of the inverter input voltage.</li> </ul>

Alarm ID	Alarm Name	Alarm Severity	Possible Causes	Troubleshooting
			<p>combined or exchanged.</p> <ul style="list-style-type: none"> <li>• Cause ID = 8 The sunlight is weak or changes abnormally.</li> <li>• Cause ID = 9 In partial configuration scenarios, the PV string voltage exceeds the inverter input voltage specifications.</li> </ul>	
2081	Optimizer fault	Warning	<p>Cause ID = 1 The optimizer is offline or faulty.</p>	Go to the optimizer information screen to view the fault details.
2085	Built-in PID operation abnormal	Minor	<p>Cause ID = 1, 2</p> <ul style="list-style-type: none"> <li>• The output resistance of PV arrays to ground is low.</li> <li>• The system insulation resistance is low.</li> </ul>	<ul style="list-style-type: none"> <li>• Cause ID = 1 <ol style="list-style-type: none"> <li>1. Turn off the AC output switch and DC input switch, wait for a period of time (for details about the wait time, see the description on the device safety warning label), and then turn on the DC input switch and AC output switch.</li> <li>2. If the alarm persists, contact your dealer or Huawei technical support.</li> </ol> </li> <li>• Cause ID = 2 <ol style="list-style-type: none"> <li>1. Check the impedance between the PV array output and the ground. If a short circuit occurs or the insulation is insufficient, rectify the fault.</li> <li>2. If the alarm persists, contact your dealer or Huawei technical support.</li> </ol> </li> </ul>

Alarm ID	Alarm Name	Alarm Severity	Possible Causes	Troubleshooting
2086	External fan abnormal	Major	Cause ID = 1 The external fan is short-circuited, the power supply is insufficient, or the air channel is blocked.	<ol style="list-style-type: none"> <li>1. Shut down the fan, turn off the DC switch, check whether the fan blades are damaged, and clear the foreign matter around the fan.</li> <li>2. Reinstall the fan, turn on the DC switch, and wait for the inverter to start. If the alarm persists after 15 minutes, replace the external fan.</li> </ol>
2090	Abnormal active power scheduling instruction	Major	Cause ID = 1 <ul style="list-style-type: none"> <li>• The DI input is abnormal.</li> <li>• The DI input is inconsistent with the configuration.</li> </ul>	<ol style="list-style-type: none"> <li>1. Check whether the cables are connected correctly to the DI ports.</li> <li>2. On the <b>DI active scheduling</b> screen under the dry contact scheduling settings, view the DI signal configuration mapping table. Contact the power grid company to check whether the configurations in the mapping table are complete and meet the requirements.</li> </ol>
2091	Abnormal reactive power scheduling instruction	Major	Cause ID = 1 <ul style="list-style-type: none"> <li>• The DI input is abnormal.</li> <li>• The DI input is inconsistent with the configuration.</li> </ul>	<ol style="list-style-type: none"> <li>1. Check whether the cables are connected correctly to the DI ports.</li> <li>2. On the <b>DI reactive power scheduling</b> screen under the dry contact scheduling settings, view the DI signal configuration mapping table. Contact the power grid company to check whether the configurations in the mapping table are complete and meet the requirements.</li> </ol>
2102	Protection upon Communication Failure	Warning	Cause ID = 1 When the disconnection of communication exceeds the specified time threshold, the device starts the protection function.	<ol style="list-style-type: none"> <li>1. Check whether the communications cable is connected properly.</li> <li>2. After communication is restored, the device will recover upon receiving a scheduling command.</li> <li>3. If the <b>Protection upon Communication Failure</b> function is not required, disable it.</li> </ol>

## 8.4 Replacing a Fan

**CAUTION**

- Before replacing a fan, power off the inverter.
- When replacing a fan, use insulated tools and wear PPE.

### Procedure

**Step 1** Remove the fan cover, disconnect fan cables, and remove the faulty fan.

**Figure 8-1** Removing a faulty fan

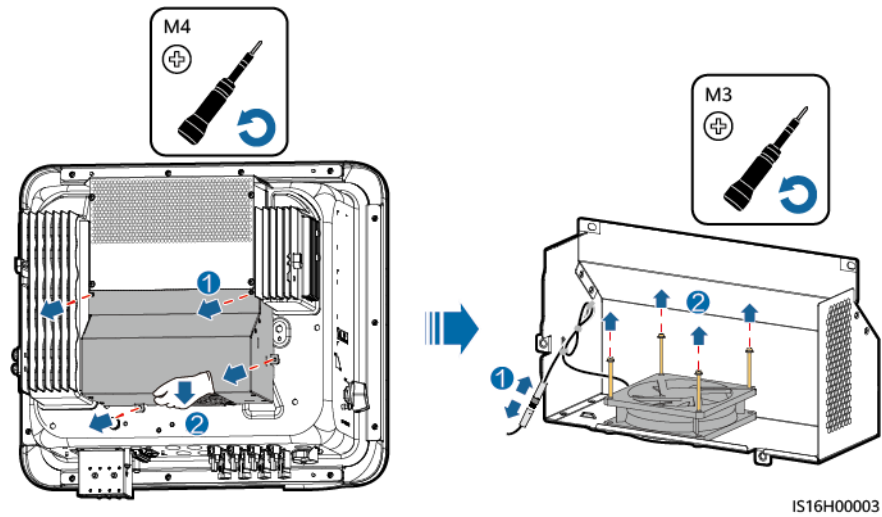

**Step 2** Install a new fan, connect and bind the cables, and install the fan cover.

----End

# 9 Handling the Inverter

---

## 9.1 Removing the SUN2000

---

**NOTICE**

Before removing the SUN2000, disconnect both AC and DC connections.

---

Perform the following operations to remove the SUN2000:

1. Disconnect all cables from the SUN2000, including RS485 communications cables, DC input power cables, AC output power cables, and PGND cables.
2. Remove the SUN2000 from the mounting bracket.
3. Remove the mounting bracket.

## 9.2 Packing the SUN2000

- If the original packing materials are available, put the SUN2000 inside them and then seal them by using adhesive tape.
- If the original packing materials are not available, put the SUN2000 inside a suitable cardboard box and seal it properly.

## 9.3 Disposing of the SUN2000

If the SUN2000 service life expires, dispose of it according to the local disposal rules for electrical equipment waste.

# 10 Technical Specifications

## 10.1 SUN2000-(15KTL-25KTL)-ZHM5 Technical Specifications

### Efficiency

Item	SUN2000-15KTL-ZHM5	SUN2000-17KTL-ZHM5	SUN2000-20KTL-ZHM5	SUN2000-25KTL-ZHM5
Maximum efficiency	98.5%	98.5%	98.5%	98.5%
Chinese efficiency	97.4%	97.4%	97.6%	98.0%

### Input

Item	SUN2000-15KTL-ZHM5	SUN2000-17KTL-ZHM5	SUN2000-20KTL-ZHM5	SUN2000-25KTL-ZHM5
Recommended maximum input DC power	22500 W	25500 W	30000 W	37500 W
Maximum input voltage <sup>a</sup>	1100 V			
Maximum input current per MPPT	20 A (one PV string)/30 A (one MPPT)			
Maximum short-circuit current per MPPT	40 A			
Minimum startup voltage	200 V			

Item	SUN2000-15KTL-ZHM5	SUN2000-17KTL-ZHM5	SUN2000-20KTL-ZHM5	SUN2000-25KTL-ZHM5
MPPT voltage range	200–1000 V			
Full-load MPPT voltage range	410–800 V	440–800 V	480–800 V	530–800 V
Rated input voltage	600 V			
Maximum number of inputs	4			
Number of MPPTs	2			
Note a: The maximum input voltage is the maximum DC input voltage that the inverter can withstand. If the input voltage exceeds this value, the inverter may be damaged.				

## Output

Item	SUN2000-15KTL-ZHM5	SUN2000-17KTL-ZHM5	SUN2000-20KTL-ZHM5	SUN2000-25KTL-ZHM5
Rated output power	15000 W	17000 W	20000 W	25000 W
Maximum apparent power	16500 VA	18700 VA	22000 VA	27500 VA
Maximum active power (cos $\phi$ = 1)	16500 W	18700 W	22000 W	27500 W
Rated output voltage	220 V/380 V, 3W/N+PE 230 V/400 V, 3W/N+PE 239.6 V/415 V, 3W/N+PE			
Maximum output voltage at long-term operation	See standards about the local power grid.			
Rated output current	22.8 A/380 V 21.7 A/400 V 20.9 A/415 V	25.8 A/380 V 24.5 A/400 V 23.7 A/415 V	30.4 A/380 V 28.9 A/400 V 27.8 A/415 V	38.0 A/380 V 36.1 A/400 V 34.8 A/415 V
Maximum output current	25.2 A/380 V 23.9 A/400 V 23.1 A/415 V	28.6 A/380 V 27.1 A/400 V 26.1 A/415 V	33.6 A/380 V 31.9 A/400 V 30.8 A/415 V	42.0 A/380 V 39.9 A/400 V 38.5 A/415 V

Item	SUN2000-15KTL-ZHM5	SUN2000-17KTL-ZHM5	SUN2000-20KTL-ZHM5	SUN2000-25KTL-ZHM5
Output voltage frequency	50 Hz/60 Hz			
Power factor	0.8 leading... 0.8 lagging			
Output DC component DCI	< 0.25% of the rated output			
Maximum total harmonic distortion AC THDI	< 3% under rated conditions. Single-order harmonic meets the VDE4105 requirements.			

## Protection

Item	SUN2000-15KTL-ZHM5	SUN2000-17KTL-ZHM5	SUN2000-20KTL-ZHM5	SUN2000-25KTL-ZHM5
Overvoltage category	PV II/AC III			
Input DC switch	Supported			
Anti-islanding protection	Supported			
Output overcurrent protection	Supported			
Input reverse connection protection	Supported			
DC surge protection	TYPE II			
AC surge protection	CLASS II			
Insulation resistance detection	Supported			
Residual current monitoring unit (RCMU)	Supported			



## Display and Communication

Item	SUN2000-15KTL-ZHM5	SUN2000-17KTL-ZHM5	SUN2000-20KTL-ZHM5	SUN2000-25KTL-ZHM5
Display	LED indicators; WLAN+app			
WLAN/FE Dongle	Supported			
4G Dongle	Optional			
RS485 communication	Supported			
Built-in WLAN	Supported			
DC MBUS	Supported			
AFCI	Supported			
PID recovery	Supported			

## General

Item	SUN2000-15KTL-ZHM5	SUN2000-17KTL-ZHM5	SUN2000-20KTL-ZHM5	SUN2000-25KTL-ZHM5
Dimensions (H x W x D)	460 mm x 546 mm x 228 mm			
Net weight	21 kg			
Operating temperature	-25°C to +60°C			
Relative humidity	0-100%			
Cooling mode	Smart air cooling			
Maximum operating altitude	4000 m (derated when the altitude is greater than 2000 m)			
Storage temperature	-40°C to +70°C			
IP rating	IP66			
Topology	Transformerless			

## Wireless Communication Parameters

Specifications	Inverter Built-in WiFi	WLAN-FE Smart Dongle	4G Smart Dongle
Frequency	2400–2483.5 MHz	SDongleA-05: 2400–2483.5 MHz	<p>SDongleA-03-CN:</p> <ul style="list-style-type: none"> <li>• Supports LTE-FDD: B1/B3/B8.</li> <li>• Supports LTE-TDD: B38/B39/B40/B41.</li> <li>• Supports DC-HSPA+/HSPA+/HSPA/UMTS: B1/B5/B8/B9.</li> <li>• Supports TD-SCDMA: B34/B39.</li> <li>• Supports GSM/GPRS/EDGE: 900 MHz/1800 MHz.</li> </ul> <p>SDongleB-03-CN:</p> <ul style="list-style-type: none"> <li>• Supports LTE-FDD: B1/B3/B5/B8.</li> <li>• Supports LTE-TDD: B34/B38/B39/B40/B41.</li> <li>• Supports GSM/GPRS/EDGE: 900 MHz/1800 MHz.</li> </ul> <p>SDongleB-06-CN (WiFi): 2400–2483.5 MHz</p> <p>SDongleB-06-CN (4G):</p> <ul style="list-style-type: none"> <li>• Supports LTE-FDD: B1/B3/B5/B8.</li> <li>• Supports LTE-TDD: B34/B38/B39/B40/B41.</li> <li>• Supports GSM/GPRS/EDGE: 900 MHz/1800 MHz.</li> </ul>

Specifications	Inverter Built-in WiFi	WLAN-FE Smart Dongle	4G Smart Dongle
Protocol standard	WLAN 802.11b/g/n	SDongleA-05: WLAN 802.11b/g/n	<p>SDongleA-03-CN:</p> <ul style="list-style-type: none"> <li>• Supports LTE-FDD (with receive diversity): B1/B3/B5/B8.</li> <li>• Supports LTE-TDD (with receive diversity): B34/B38/B39/B40/B41.</li> <li>• Supports WCDMA: B1/B5/B8.</li> <li>• Supports GSM: 900 MHz/1800 MHz.</li> <li>• Supports digital audio.</li> </ul> <p>SDongleB-03-CN:</p> <ul style="list-style-type: none"> <li>• Supports LTE-FDD (with receive diversity): B1/B3/B5/B8.</li> <li>• Supports LTE-TDD (with receive diversity): B34/B38/B39/B40/B41.</li> <li>• Supports GSM: 900 MHz/1800 MHz.</li> <li>• Supports digital audio.</li> </ul> <p>SDongleB-06-CN (WiFi): WLAN 802.11b/g/n</p> <p>SDongleB-06-CN (4G):</p> <ul style="list-style-type: none"> <li>• Supports LTE-FDD (with receive diversity): B1/B3/B5/B8.</li> <li>• Supports LTE-TDD (with receive diversity): B34/B38/B39/B40/B41.</li> <li>• Supports GSM: 900 MHz/1800 MHz.</li> <li>• Supports digital audio.</li> </ul>

Specifications	Inverter Built-in WiFi	WLAN-FE Smart Dongle	4G Smart Dongle
Bandwidth	20 MHz/40 MHz (optional)	20 MHz/40 MHz (optional)	<p>LTE features:</p> <ul style="list-style-type: none"> <li>• Supports a maximum of 3GPP R8 non-CA Cat 4 FDD and TDD.</li> <li>• Supports 1.4 MHz/3 MHz/5 MHz/10 MHz/15 MHz/20 MHz RF bandwidth.</li> <li>• Supports MIMO in the downlink.</li> <li>• LTE-FDD: maximum downlink rate of 150 Mbit/s and maximum uplink rate of 50 Mbit/s</li> <li>• LTE-TDD: maximum downlink rate of 130 Mbit/s and maximum uplink rate of 30 Mbit/s</li> </ul> <p>UMTS features:</p> <ul style="list-style-type: none"> <li>• Supports 3GPP R7 HSDPA+, HSDPA, HSUPA, and WCDMA.</li> <li>• Supports QPSK and 16QAM modulation.</li> <li>• HSDPA+: maximum downlink rate of 21 Mbit/s</li> <li>• HSUPA: maximum uplink rate of 5.76 Mbit/s</li> <li>• WCDMA: maximum downlink rate of 384 kbit/s and maximum uplink rate of 384 kbit/s</li> </ul> <p>GSM features:</p> <p>GPRS:</p> <ul style="list-style-type: none"> <li>• Supports GPRS multislots class 12.</li> <li>• Coding schemes: CS-1, CS-2, CS-3, and CS-4</li> <li>• Maximum downlink rate: 85.6 kbit/s; maximum uplink rate: 85.6 kbit/s</li> </ul> <p>EDGE:</p> <ul style="list-style-type: none"> <li>• Supports EDGE multislots class 12.</li> <li>• Supports GMSK and 8-PSK modulation and coding schemes.</li> <li>• Downlink coding format: MCS 1-9</li> <li>• Uplink coding format: MCS 1-9</li> <li>• Maximum downlink rate: 236.8 kbit/s; maximum uplink rate: 236.8 kbit/s</li> </ul> <p>SDongleB-06-CN (WiFi): 20 MHz/40 MHz (optional)</p>

Specifications	Inverter Built-in WiFi	WLAN-FE Smart Dongle	4G Smart Dongle
Maximum transmit power	≤ 20 dBm EIRP	≤ 20 dBm EIRP	<ul style="list-style-type: none"> <li>Class 4 (33 dBm±2 dB), EGSM900 frequency band</li> <li>Class 1 (30 dBm±2 dB), DCS1800 frequency band</li> <li>Class E2 (27 dBm±3 dB), EGSM900 8-PSK</li> <li>Class E2 (26 dBm±3 dB), DCS1800 8-PSK</li> <li>Class 3 (24 dBm+1/-3 dB), WCDMA frequency band</li> <li>Class 3 (23 dBm±2 dB), LTE-FDD frequency band</li> <li>Class 3 (23 dBm±2 dB), LTE-TDD frequency band</li> </ul> SDongleB-06-CN (WiFi): ≤ 20 dBm EIRP

## 10.2 SUN2000-(12KTL-25KTL)-M5 Technical Specifications

### Efficiency

Item	SUN2000-12K TL-M5	SUN2000-15K TL-M5	SUN2000-17K TL-M5	SUN2000-20K TL-M5	SUN2000-25K TL-M5
Maximum efficiency	98.4%	98.4%	98.4%	98.4%	98.4%
European efficiency	97.9%	98.0%	98.1%	98.1%	98.2%

### Input

Item	SUN2000-12K TL-M5	SUN2000-15K TL-M5	SUN2000-17K TL-M5	SUN2000-20K TL-M5	SUN2000-25K TL-M5
Recommended maximum input DC power	18000 W	22500 W	25500 W	30000 W	37500 W
Maximum input voltage <sup>a</sup>	1100 V				

Item	SUN2000-12K TL-M5	SUN2000-15K TL-M5	SUN2000-17K TL-M5	SUN2000-20K TL-M5	SUN2000-25K TL-M5
Maximum input current per MPPT	20 A (one PV string)/30 A (one MPPT)				
Maximum short-circuit current per MPPT	40 A				
Minimum startup voltage	200 V				
MPPT voltage range	200–1000 V				
Full-load MPPT voltage range	370–800 V	410–800 V	440–800 V	480–800 V	530–800 V
Rated input voltage	600 V				
Maximum number of inputs	4				
Number of MPPTs	2				
Note a: The maximum input voltage is the maximum DC input voltage that the inverter can withstand. If the input voltage exceeds this value, the inverter may be damaged.					

## Output

Item	SUN2000-12K TL-M5	SUN2000-15K TL-M5	SUN2000-17K TL-M5	SUN2000-20K TL-M5	SUN2000-25K TL-M5
Rated output power	12000 W	15000 W	17000 W	20000 W	25000 W
Maximum apparent power	13200 VA	16500 VA	18700 VA	22000 VA	27500 VA
Maximum active power (cos $\phi$ = 1)	13200 W	16500 W	18700 W	22000 W	27500 W

Item	SUN2000-12K TL-M5	SUN2000-15K TL-M5	SUN2000-17K TL-M5	SUN2000-20K TL-M5	SUN2000-25K TL-M5
Rated output voltage	220 V/380 V, 3W/N+PE 230 V/400 V, 3W/N+PE 239.6 V/415 V, 3W/N+PE				
Maximum output voltage at long-term operation	See standards about the local power grid.				
Rated output current	18.2 A/380 V 17.3 A/400 V 16.7 A/415 V	22.8 A/380 V 21.7 A/400 V 20.9 A/415 V	25.8 A/380 V 24.5 A/400 V 23.7 A/415 V	30.4 A/380 V 28.9 A/400 V 27.8 A/415 V	38.0 A/380 V 36.1 A/400 V 34.8 A/415 V
Maximum output current	20.2 A/380 V 19.1 A/400 V 18.5 A/415 V	25.2 A/380 V 23.9 A/400 V 23.1 A/415 V	28.6 A/380 V 27.1 A/400 V 26.1 A/415 V	33.6 A/380 V 31.9 A/400 V 30.8 A/415 V	42.0 A/380 V 39.9 A/400 V 38.5 A/415 V
Output voltage frequency	50 Hz/60 Hz				
Power factor	0.8 leading ... 0.8 lagging				
Output DC component DCI	< 0.25% of the rated output				
Maximum total harmonic distortion AC THDI	< 3% under rated conditions. Single-order harmonic meets the VDE4105 requirements.				

## Protection

Item	SUN2000-12K TL-M5	SUN2000-15K TL-M5	SUN2000-17K TL-M5	SUN2000-20K TL-M5	SUN2000-25K TL-M5
Overvoltage category	PV II/AC III				
Input DC switch	Supported				
Anti-islanding protection	Supported				

Item	SUN2000-12K TL-M5	SUN2000-15K TL-M5	SUN2000-17K TL-M5	SUN2000-20K TL-M5	SUN2000-25K TL-M5
Output overcurrent protection	Supported				
Input reverse connection protection	Supported				
DC surge protection	TYPE II				
AC surge protection	CLASS II				
Insulation resistance detection	Supported				
Residual current monitoring unit (RCMU)	Supported				

## Display and Communication

Item	SUN2000-12K TL-M5	SUN2000-15K TL-M5	SUN2000-17K TL-M5	SUN2000-20K TL-M5	SUN2000-25K TL-M5
Display	LED indicators; WLAN+app				
WLAN/FE Dongle	Supported				
4G Dongle	Optional				
RS485 communication	Supported				
Built-in WLAN	Supported				
DC MBUS	Supported				
AFCI	Supported				
PID recovery	Supported				



## General

Item	SUN2000-12K TL-M5	SUN2000-15K TL-M5	SUN2000-17K TL-M5	SUN2000-20K TL-M5	SUN2000-25K TL-M5
Dimensions (H x W x D)	460 mm x 546 mm x 228 mm				
Net weight	21 kg				
Operating temperature	-25°C to +60°C				
Relative humidity	0-100%				
Cooling mode	Smart air cooling				
Maximum operating altitude	4000 m (derated when the altitude is greater than 2000 m)				
Storage temperature	-40°C to +70°C				
IP rating	IP66				
Topology	Transformerless				

## Wireless Communication Parameters

Specifications	Inverter Built-in WiFi	WLAN-FE Smart Dongle	4G Smart Dongle
Frequency	2400-2483.5 MHz	SDongleA-05: 2400-2483.5 MHz	SDongleA-03-EU: <ul style="list-style-type: none"> <li>Supports LTE-FDD: B1/B3/B7/B8/B20.</li> <li>Supports LTE-TDD: B38/B40.</li> <li>Supports WCDMA/HSDPA/HSUPA/HSPA+: B1/B8.</li> <li>Supports GSM/GPRS/EDGE: 900 MHz/1800 MHz.</li> </ul> SDongleB-06-EU (WiFi): 2400-2483.5 MHz SDongleB-06-EU (4G): <ul style="list-style-type: none"> <li>Supports LTE-FDD: B1/B3/B5/B8.</li> <li>Supports LTE-TDD: B7/B20/B28/B38/B40/B41.</li> <li>Supports GSM/GPRS/EDGE: 900 MHz/1800 MHz.</li> </ul>

Specifications	Inverter Built-in WiFi	WLAN-FE Smart Dongle	4G Smart Dongle
Protocol standard	WLAN 802.11b/g/n	SDongleA-05: WLAN 802.11b/g/n	SDongleA-03-EU: <ul style="list-style-type: none"> <li>• Supports LTE-FDD (with receive diversity): B1/B3/B7/B8/B20/B28.</li> <li>• Supports LTE-FDD (with receive diversity): B38/B40/B41.</li> <li>• Supports WCDMA: B1/B8.</li> <li>• Supports GSM: 900 MHz/1800 MHz.</li> <li>• Supports digital audio.</li> </ul> SDongleB-06-EU (WiFi): WLAN 802.11b/g/n SDongleB-06-EU (4G): <ul style="list-style-type: none"> <li>• Supports LTE FDD (with receive diversity): B1/B3/B5/B8.</li> <li>• Supports LTE-TDD (with receive diversity): B7/B20/B28/B38/B40/B41.</li> <li>• Supports GSM: 900 MHz/1800 MHz.</li> <li>• Supports digital audio.</li> </ul>

Specifications	Inverter Built-in WiFi	WLAN-FE Smart Dongle	4G Smart Dongle
Bandwidth	20 MHz/40 MHz (optional)	20 MHz/40 MHz (optional)	<p>LTE features:</p> <ul style="list-style-type: none"> <li>• Supports a maximum of 3GPP R8 non-CA Cat 4 FDD and TDD.</li> <li>• Supports 1.4 MHz/3 MHz/5 MHz/10 MHz/15 MHz/20 MHz RF bandwidth.</li> <li>• Supports MIMO in the downlink.</li> <li>• LTE-FDD: maximum downlink rate of 150 Mbit/s and maximum uplink rate of 50 Mbit/s</li> <li>• LTE-TDD: maximum downlink rate of 130 Mbit/s and maximum uplink rate of 30 Mbit/s</li> </ul> <p>UMTS features:</p> <ul style="list-style-type: none"> <li>• Supports 3GPP R7 HSDPA+, HSDPA, HSUPA, and WCDMA.</li> <li>• Supports QPSK and 16QAM modulation.</li> <li>• HSDPA+: maximum downlink rate of 21 Mbit/s</li> <li>• HSUPA: maximum uplink rate of 5.76 Mbit/s</li> <li>• WCDMA: maximum downlink rate of 384 kbit/s and maximum uplink rate of 384 kbit/s</li> </ul> <p>GSM features:</p> <p>GPRS:</p> <ul style="list-style-type: none"> <li>• Supports GPRS multislots class 12.</li> <li>• Coding schemes: CS-1, CS-2, CS-3, and CS-4</li> <li>• Maximum downlink rate: 85.6 kbit/s; maximum uplink rate: 85.6 kbit/s</li> </ul> <p>EDGE:</p> <ul style="list-style-type: none"> <li>• Supports EDGE multislots class 12.</li> <li>• Supports GMSK and 8-PSK modulation and coding schemes.</li> <li>• Downlink coding format: MCS 1-9</li> <li>• Uplink coding format: MCS 1-9</li> <li>• Maximum downlink rate: 236.8 kbit/s; maximum uplink rate: 236.8 kbit/s</li> </ul> <p>SDongleB-06-EU (WiFi): 20 MHz/40 MHz (optional)</p>

Specifications	Inverter Built-in WiFi	WLAN-FE Smart Dongle	4G Smart Dongle
Maximum transmit power	≤ 20 dBm EIRP	≤ 20 dBm EIRP	<ul style="list-style-type: none"> <li>• Class 4 (33 dBm±2 dB), EGSM900 frequency band</li> <li>• Class 1 (30 dBm±2 dB), DCS1800 frequency band</li> <li>• Class E2 (27 dBm±3 dB), EGSM900 8-PSK</li> <li>• Class E2 (26 dBm±3 dB), DCS1800 8-PSK</li> <li>• Class 3 (24 dBm+1/-3 dB), WCDMA frequency band</li> <li>• Class 3 (23 dBm±2 dB), LTE-FDD frequency band</li> <li>• Class 3 (23 dBm±2 dB), LTE-TDD frequency band</li> </ul> SDongleB-06-EU (WiFi): ≤ 20 dBm EIRP

# A Grid Codes

## NOTE

The grid codes are subject to change. The listed codes are for reference only.

**Table A-1** SUN2000-(15KTL-25KTL)-ZHM5 grid codes

No.	Grid Code	Description	SUN2000-15KTL-ZHM5	SUN2000-17KTL-ZHM5	SUN2000-20KTL-ZHM5	SUN2000-25KTL-ZHM5
1	NB/T 32004	China Golden Sun low-voltage power grid	Supported	Supported	Supported	Supported
2	CHINA-LV220/380	China low-voltage power grid	Supported	Supported	Supported	Supported

**Table A-2** SUN2000-(12KTL-25KTL)-M5 grid codes

No.	Grid Code	Description	SUN2000-12KTL-M5	SUN2000-15KTL-M5	SUN2000-17KTL-M5	SUN2000-20KTL-M5	SUN2000-25KTL-M5
1	TAIPOWER	Taiwan Power low-voltage power grid	Supported	Supported	Supported	Supported	Supported
2	OMAN	Oman low-voltage power grid	Supported	Supported	Supported	Supported	Supported
3	Pakistan	Pakistan power grid	Supported	Supported	Supported	Supported	Supported

No.	Grid Code	Description	SUN2000-12KTL-M5	SUN2000-15KTL-M5	SUN2000-17KTL-M5	SUN2000-20KTL-M5	SUN2000-25KTL-M5
4	SINGAPORE	Singapore low-voltage power grid	Supported	Supported	Supported	Supported	Supported
5	HONGKONG	Hong Kong low-voltage power grid	Supported	Supported	Supported	Supported	Supported
6	SWITZERLAND-NA/EEA:2020-LV230	Switzerland power grid	Supported	Supported	Supported	Supported	Supported
7	NA_CODE	Default country code	Supported	Supported	Supported	Supported	Supported

# B Device Commissioning

**Step 1** Access **Device Commissioning** screen.

**Figure B-1** Method 1: before login (not connected to the Internet)

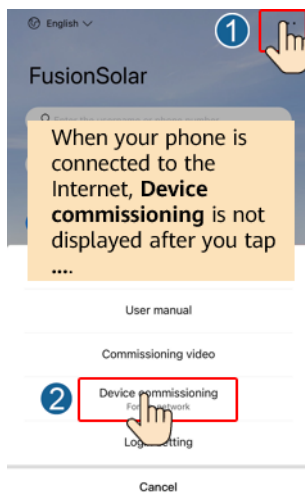

**Figure B-2** Method 2: after login (connected to the Internet)

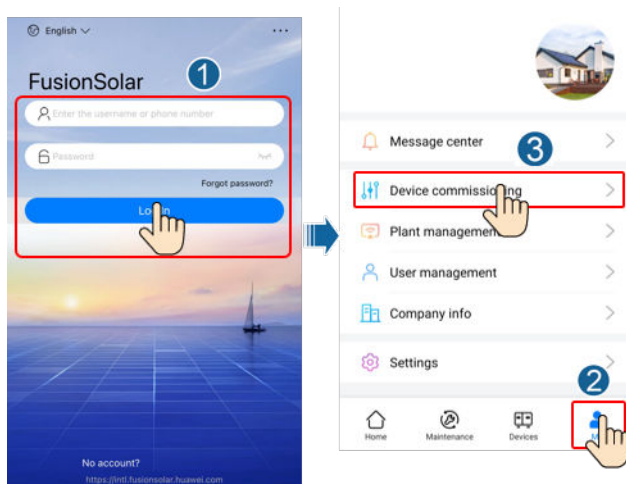

**Step 2** Connect to the solar inverter WLAN and log in to the device commissioning screen as the **installer** user.

---

**NOTICE**

- If the mobile phone is directly connected to the SUN2000, the visible distance between the SUN2000 and the mobile phone must be less than 3 m when a built-in antenna is used and less than 50 m when an external antenna is used to ensure the communication quality between the App and the SUN2000. The distances are for reference only and may vary with mobile phones and shielding conditions.
- When connecting the SUN2000 to the WLAN over a router, ensure that the mobile phone and SUN2000 are in the WLAN coverage of the router and the SUN2000 is connected to the router.
- The router supports WLAN (IEEE 802.11 b/g/n, 2.4 GHz) and the WLAN signal reaches the SUN2000.
- The WPA, WPA2, or WPA/WPA2 encryption mode is recommended for routers. Enterprise-level encryption is not supported (for example, public hotspots requiring authentication such as airport WLAN). WEP and WPA TKIP are not recommended because these two encryption modes have serious security defects. If the access fails in WEP mode, log in to the router and change the encryption mode of the router to WPA2 or WPA/WPA2.

---

 **NOTE**





- Obtain the initial password for connecting to the solar inverter WLAN from the label on the side of the solar inverter.
- Set the password at the first login. To ensure account security, change the password periodically and keep the new password in mind. Not changing the initial password may cause password disclosure. A password left unchanged for a long period of time may be stolen or cracked. If a password is lost, devices cannot be accessed. In these cases, the user is liable for any loss caused to the PV plant.
- When you access the **Device Commissioning** screen of the SUN2000 for the first time, you need to manually set the login password because the SUN2000 does not have an initial login password.

----End



# C Resetting Password

---

- Step 1** Check that the AC and DC sides of the inverter are both powered on, and indicators  and  are steady green or blinking slowly for more than 3 minutes.
- Step 2** Turn off the AC switch, set the DC SWITCH at the bottom of the inverter to OFF, and wait until all indicators on the inverter panel turn off.
- Step 3** Complete the following operations within 4 minutes:
1. Turn on the AC switch and wait for about 90s or until the inverter indicator  blinks.
  2. Turn off the AC switch and wait about 30s or until all LED indicators on the inverter panel turn off.
  3. Turn on the AC switch and wait for about 30s or until all LED indicators on the inverter panel blink and then turn off after about 30s.
- Step 4** Wait until the three green LEDs on the inverter panel blink fast and then the three red LEDs blink fast, which indicates that the password is restored.
- Step 5** Reset the password within 10 minutes. (If no operation is performed within 10 minutes, all parameters of the inverter remain unchanged.)
1. Wait until the indicator  blinks.
  2. Connect to the app using the initial WLAN hotspot name (SSID) and initial password (PSW), which can be obtained from the label on the side of the inverter.
  3. On the login page, set a new password and log in to the app.
- Step 6** Set router and management system parameters to implement remote management.

----End

---

## NOTICE

You are advised to reset the password in the morning or at night when the solar irradiance is low.

---

# D Locating Insulation Resistance Faults

If the ground impedance of a PV string connected to the inverter is too low, the inverter generates a **Low insulation resistance** alarm.

The possible causes are as follows:

- A short circuit has occurred between the PV array and the ground.
- The ambient air of the PV array is damp and the insulation between the PV array and the ground is poor.

After the **Low insulation resistance** alarm is reported by the inverter, insulation resistance fault location is automatically triggered. If the fault location is successful, the location information is displayed on the **Alarm details** screen of the **Low insulation resistance** alarm on the FusionSolar app.

Log in to the FusionSolar app, choose **Alarm > Active alarm**, select **Low insulation resistance** to enter the **Alarm details** screen.

Figure D-1 Alarm details

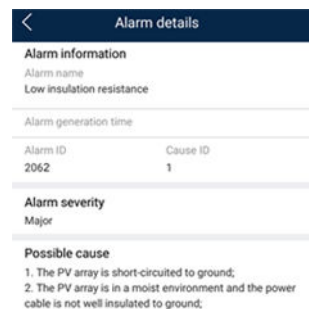

**NOTE**

- The positive and negative terminals of a PV string are respectively connected to the PV+ and PV- terminals of the inverter. The PV- terminal represents a possibility of 0% for the short-circuit position and the PV+ terminal represents a possibility of 100% for the short-circuit position. Other percentages indicate that the fault occurs on a PV module or cable in the PV string.
- Possible fault position = Total number of PV modules in a PV string x Percentage of possible short-circuit positions. For example, if a PV string consists of 14 PV modules and the percentage of the possible short-circuit position is 34%, the possible fault position is 4.76 (14 x 34%), indicating that the fault is located near PV module 4, including the previous and the next PV modules and the cables. The inverter has a detection precision of  $\pm 1$  PV module.
- The possible faulty PV string MPPT1 corresponds to PV1 and PV2, and the possible faulty PV string MPPT2 corresponds to PV3 and PV4. The fault can be located only to the MPPT level. Perform the following steps to connect the PV strings corresponding to the faulty MPPT to the inverter one by one to further locate and rectify the fault.
- When a non-short-circuit fault occurs, the possible short-circuit percentage is not displayed. If the insulation resistance is greater than  $0.001 \text{ M}\Omega$ , the fault is not related to short circuit. Check all PV modules in the faulty PV string one by one to locate and rectify the fault.

**Figure D-2** Percentage of short-circuit positions

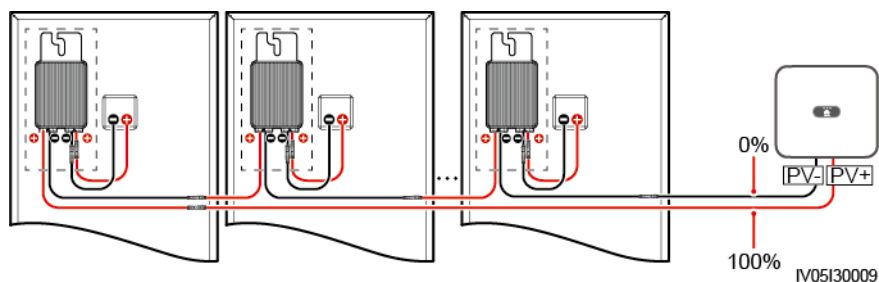

## Procedure

**NOTICE**

If the irradiance or the PV string voltage is too high, the insulation resistance fault location may fail. In this case, the fault location status on the **Alarm details** screen is **Conditions not met**. Perform the following steps to connect PV strings to the inverter one by one to locate the fault. If the system is not configured with any optimizer, skip the corresponding optimizer operations.

- Step 1** Ensure that the AC connections are normal. Log in to the FusionSolar app, choose **Maintenance > Inverter ON/OFF** on the home screen, and send a shutdown command. Set **DC SWITCH** to **OFF**.
- Step 2** Connect one PV string to the inverter, and set **DC SWITCH** to **ON**. If the inverter status is **Shutdown: Command**, log in to the app, choose **Maintenance > Inverter ON/OFF** on the home screen, and send a startup command.
- Step 3** Choose **Alarm** on the home screen, enter the **Active alarm** screen, and check whether a **Low insulation resistance** alarm is reported.

- If no **Low insulation resistance** alarm is reported 1 minute after the DC side is powered on, choose **Maintenance > Inverter ON/OFF** on the home screen, and send a shutdown command. Set **DC SWITCH** to **OFF**. Go to Step 2 and check rest of the PV strings one by one.
- If a **Low insulation resistance** alarm is reported 1 minute after the DC side is powered on, check the percentage of possible short-circuit positions on the **Alarm details** screen and calculate the location of the possible faulty PV module based on the percentage. Then go to **Step 4**.

**Step 4** Log in to the app, choose **Maintenance > Inverter ON/OFF** on the home screen, and send a shutdown command. Set **DC SWITCH** to **OFF**. Check whether the connectors or DC power cables between the optimizer and PV module, between adjacent PV modules, or between adjacent optimizers on the possible fault position are damaged.

- If yes, replace the damaged connectors or DC power cables, and then set **DC SWITCH** to **ON**. If the inverter status is **Shutdown: Command**, choose **Maintenance > Inverter ON/OFF**, and send a startup command. View alarm information.
  - If no **Low insulation resistance** alarm is reported 1 minute after the DC side is powered on, troubleshoot the insulation resistance fault of the PV string. Log in to the app, choose **Maintenance > Inverter ON/OFF** on the home screen, and send a shutdown command. Set **DC SWITCH** to **OFF**. Go to Step 2 and check rest of the PV strings one by one. Then, go to **Step 8**.
  - If the DC side is powered on 1 minute later, the **Low insulation resistance** alarm is still reported. Log in to the app, choose **Maintenance > Inverter ON/OFF** on the home screen, and send a shutdown command. Set **DC SWITCH** to **OFF** and go to **Step 5**.
- If no, go to **Step 5**.

**Step 5** Disconnect the possible faulty PV module and the paired optimizer from the PV string, and use a DC extension cable with an MC4 connector to connect the PV module or optimizer adjacent to the possible faulty PV module. Set **DC SWITCH** to **ON**. If the inverter status is **Shutdown: Command**, choose **Maintenance > Inverter ON/OFF** on the home screen, and send a startup command. View alarm information.

- If no **Low insulation resistance** alarm is reported 1 minute after the DC side is powered on, the fault occurred on the disconnected PV module and optimizer. Choose **Maintenance > Inverter ON/OFF**, send a shutdown command, and set **DC SWITCH** to **OFF**. Go to **Step 7**.
- If the **Low insulation resistance** alarm is reported 1 minute after the DC side is powered on, the fault did not occur on the disconnected PV module and optimizer. Go to **Step 6**.

**Step 6** Log in to the app, choose **Maintenance > Inverter ON/OFF** on the home screen, and send a shutdown command. Set **DC SWITCH** to **OFF**, reconnect the disconnected PV module and optimizer, and repeat **Step 5** to check the PV modules and optimizers adjacent to the possible fault location.

**Step 7** Determine the position of the ground insulation fault:

- Disconnect the possible faulty PV module from the optimizer.

- Connect the possible faulty optimizer to the PV string.
- Set **DC SWITCH** to **ON**. If the inverter status is **Shutdown: Command**, choose **Maintenance > Inverter ON/OFF**, and send a startup command. View alarm information.
  - If no **Low insulation resistance** alarm is reported 1 minute after the DC side is powered on, the fault is on the possible faulty PV module.
  - If the **Low insulation resistance** alarm is reported 1 minute after the DC side is powered on, the fault is on the possible faulty optimizer.
- Log in to the app, choose **Maintenance > Inverter ON/OFF** on the home screen, and send a shutdown command. Set **DC SWITCH** to **OFF**, replace the faulty component, and complete troubleshooting the insulation resistance fault. Go to Step 2 and check rest of the PV strings one by one. Then, go to **Step 8**.

**Step 8** Set **DC SWITCH** to **ON**. If the inverter status is **Shutdown: Command**, choose **Maintenance > Inverter ON/OFF**, and send a startup command.

----End

# E Rapid Shutdown

## NOTE

- You are advised to periodically check whether the rapid shutdown function is normal.
- If method 3 is selected for rapid shutdown, log in to the FusionSolar app as an **installer** user to perform local commissioning, choose **Settings > Feature parameters > Dry contact function**, and set **Dry contact function** to **DI rapid shutdown**.

If optimizers are configured for all PV modules, the PV system can perform a rapid shutdown to decrease the output voltage to below 30 V within 30s.

Perform the following steps to trigger a rapid shutdown:

- Method 1: Turn off the AC switch between the inverter and the power grid (disconnect the voltages of all PV strings connected to the inverter under the AC switch).
- Method 2: Set **DC SWITCH** to **OFF** to trigger a rapid shutdown. The inverter shuts down several minutes later. (Turning off all external switches on the DC side of the inverter can trigger a rapid shutdown, which only disconnects voltages of PV strings connected to the inverter. Turning off only some external switches cannot trigger a rapid shutdown, and the PV strings may be energized.)
- Method 3: To enable the DI rapid shutdown function, connect a switch to pins DI and GND of the inverter communications terminal. The switch is turned on by default. Turn off the switch to trigger a rapid shutdown. The distance between the switch and the furthest inverter must be less than or equal to 10 m.

**Figure E-1** Connecting cables to a rapid shutdown switch

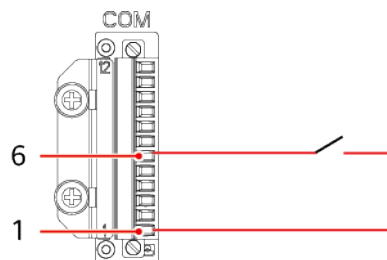

- Method 4: If **AFCI** is enabled, the inverter automatically detects arc faults and implements AFCI lock protection which will trigger a rapid shutdown.

**Figure E-2** Methods of triggering a rapid shutdown

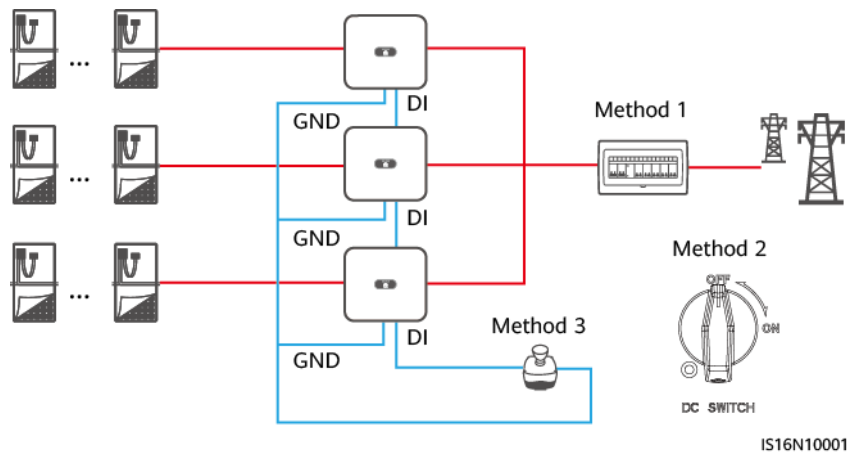

# F NS Protection

## Connecting the Inverter to the NS Protection Signal Cable

### NOTE

- The NS protection function applies to areas in compliance with the VDE4105 standard, and the grid code needs to be set to **VDE-AR-N-4105**.
- The NS protection switch is connected to GND (pin 1) at one end and to DIN5 (pin 6) at the other end. The switch is turned off by default. When the switch is turned on, NS protection is triggered. Rapid shutdown and NS protection use the same pins, which are GND (pin 1) and DIN5 (pin 6). Therefore, you can use only one of the functions.
- The NS protection switch connection is the same for a single inverter and for cascaded inverters.
- Log in to the FusionSolar App as an installer, choose **Me > Device Commissioning**, and connect to the WLAN hotspot of the SUN2000. Log in to the local commissioning system as an installer user, choose **Settings > Feature parameters > Dry contact function**, and set **Dry contact function** to **NS protection**.

Figure F-1 Connecting cascaded inverters to the NS protection switch

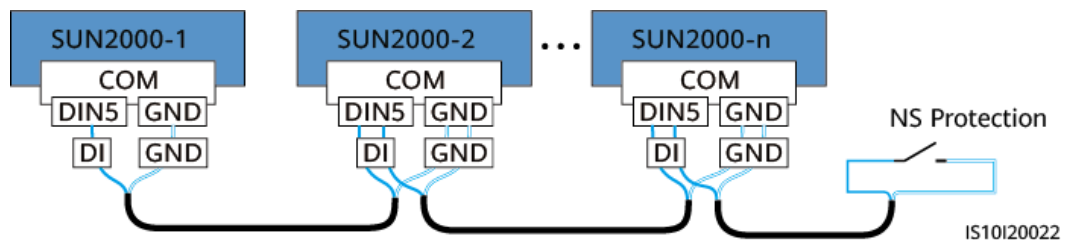



# G Preconfigured Certificate Disclaimer

---

The Huawei-issued certificates preconfigured on Huawei devices during manufacturing are mandatory identity credentials for Huawei devices. The disclaimer statements for using the certificates are as follows:

1. Preconfigured Huawei-issued certificates are used only in the deployment phase, for establishing initial security channels between devices and the customer's network. Huawei does not promise or guarantee the security of preconfigured certificates.
2. The customer shall bear consequences of all security risks and security incidents involved in using preconfigured Huawei-issued certificates as service certificates.
3. A preconfigured Huawei-issued certificate is valid until October 11, 2041 starting from the manufacturing date.
4. Services using a preconfigured Huawei-issued certificate will be interrupted when the certificate expires.
5. It is recommended that customers deploy a PKI system to issue certificates for devices and software on the live network and manage the lifecycle of the certificates. To ensure security, certificates with short validity periods are recommended.

## NOTE

You can view the validity period of a preconfigured certificate on the network management system.

---

# H Acronym and Abbreviation

---

## A

**AFCI**

arc-fault circuit interrupter

## L

**LED**

light emitting diode

## M

**MPP**

maximum power point

**MPPT**

maximum power point tracking

## P

**PE**

protective earthing

**PID**

potential induced degradation

**PV**

photovoltaic