

12

EDITION

July, 2020



Ecolight™

Save simple.

No-nonsense. Just raw efficiency.

Powered by SIGNIFY.



*ECOLIGHT
is 10 years old.
And you are the
reason why.*

4 HUMAN-CENTRIC
LIGHTING IN SCHOOLS

9 HOT FROM
THE LAB

11 INNOVATING WITH
ACADEMIC PARTNERS

14 THE MOST INTERESTING
PROJECTS IN YEAR 2019

17 BUSINESS IS JUST ONE
SIDE OF THE COIN

25 ECOLIGHT TRADEMARK
PROTECTED BY EU
AUTHORITIES

27 | **PRODUCT CATALOGUE**

LED lighting for industrial and public applications



Dear lighting industry professionals,

When I am thinking about the themes and topics of this catalogue, I am realising that ECOLIGHT is growing up fast. Companies are like people, and ours is now reaching full maturity. In this case, I am not referring to the annual revenue growth rates – no matter how pleasing and rewarding they are to the ECOLIGHT family of companies all around the world. What needs talking about is growth in scope and ambition.

Five years ago, ECOLIGHT decided to position itself strictly as a manufacturer of heavy-duty industrial luminaires. Our positioning strategy is captured in our slogan “No Nonsense. Just Raw Efficiency” which still appeals to cost-savvy factories and warehouses seeking hard-working and energy-efficient LED lights. Working shoulder to shoulder with our partners Signify (former Philips Lighting) and exchanging know-how with our country-partners worldwide, we have worked tirelessly to fortify our position in the industrial lighting market by adding a variety of unique products, including luminaires for the food industry, luminaires for chemically aggressive environments, luminaires compatible with extreme temperatures, vandal resistant luminaires, etc. Today, however, we are much bigger than just industrial lighting.

While the old line of specialisation – efficient lighting for the hard industries - continues to be the core of our business, during the last few years ECOLIGHT has successfully branched out into other fields of lighting. This catalogue features a number of stories about our efforts and breakthroughs in these new uncharted territories.

Illuminating Schools (pages 4-6)

For several years now, ECOLIGHT has been offering great lighting systems for schools seeking to embrace human-centric lighting. In this piece, we explain how lighting impacts the learning progress, and discuss three different luminaires that can both cut energy costs and improve the wellbeing of students and teachers.

Linear is the New Cool (pages 7-8)

Next up, we feature our new linear lights: LINAS OFFICE and LINAS INDUSTRY. With LINAS OFFICE, ECOLIGHT is making an inroad into the office lighting segment. LINAS INDUSTRY, on the other hand, is an excellent choice for warehouses seeking to reduce maintenance costs, optimise on energy consumption, and improve workplace satisfaction for employees.

Hot from the Lab (pages 9-13)

For a while, we kept this project hidden under a thousand locks. But it's time to get it out into the open. For the last couple of years, our engineers have been working on a truly fascinating project. In 2020, we are planning to launch our first self-learning solar-power LED luminaire that is based on IoT (Internet of Things) technology. We can't unveil all the details just yet, but I can say with confidence that MARAMA SOL is not just going to be smarter than other luminaires, it's going to be smarter than most people! You can learn more about the project in this article.

Social Responsibility (pages 22-26)

Finally, we look at the people who are making growth possible, the employees working at ECOLIGHT factory in the small provincial town of Lithuania. As most of you probably know, sixty percent of ECOLIGHT employees are people with disabilities. Social responsibility, however, is not about hiring people with disabilities, but about empowering them. We still have a lot of mountains to climb, but we are happy our efforts are being recognised. In 2018, our company won an award for the most socially responsible enterprise in Kaunas region.

As a concluding point, I would like to thank our partners in Germany, Slovenia, North Macedonia, Poland, United Arab Emirates, Great Britain, Czech Republic, Latvia, Denmark, Jordan, Ireland, Netherlands and Italy. Our country-partners are not just distributors, they are in-fact co-creators of ECOLIGHT. They are true innovators who always come up with new product ideas. A big thank you goes to all of them from all of our team.

P.S. A tip for party lovers: go straight to pages 17-21 for a recap of Signify-Ecolight summer camp 2019.

Tomas Pukas
General Manager at Ecolight

EXPORTS MARKETS

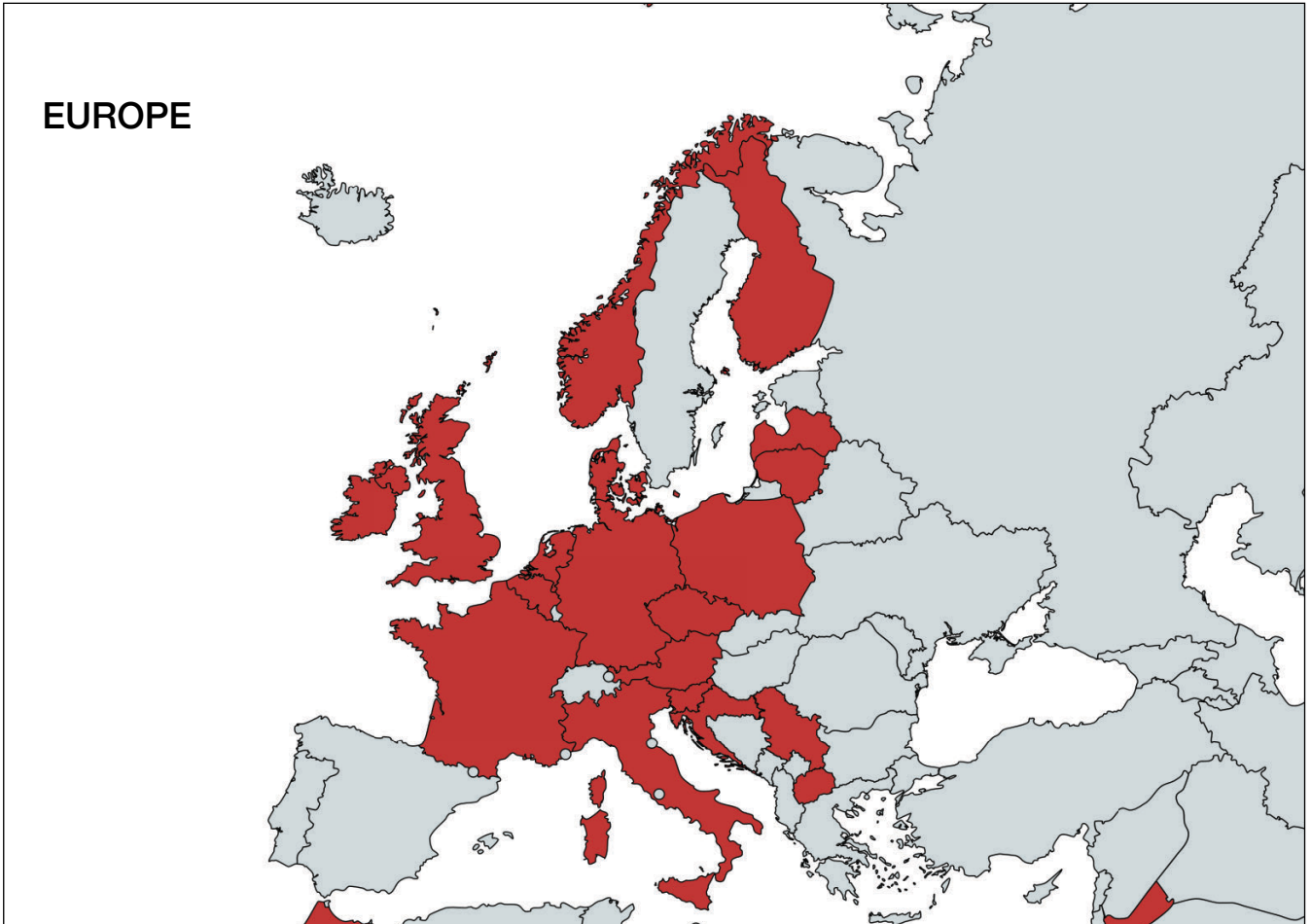

4-25
INSIGHTS

HUMAN-CENTRIC LIGHTING IN SCHOOLS **4**
SHAKING THINGS UP: ECOLIGHT LAUNCHES LINEAR LIGHTS FOR OFFICE AND INDUSTRY **7**
WE MADE A ROBOT THAT IS SMARTER THAN US **9**
INNOVATING WITH ACADEMIC PARTNERS **11**
THE MOST INTERESTING PROJECTS IN YEAR 2019 **14**
BUSINESS IS JUST ONE SIDE OF THE COIN **17**
CELEBRATING THE SOCIAL RESPONSIBILITY AWARD **22**
ECOLIGHT TRADEMARK PROTECTED BY EU AUTHORITIES **25**

28-56
HIGH BAY LED LUMINARIES

LUMINA LED LM **28**
LUMINA LED LD **30**
LUMINA LED LN **32**
SAULA LED LN **34**
SAULA LED LN Ex **37**
SAULA LED LN INOX **40**
LUMINA LED LN INOX **43**
RAMUNE LED RM GEN2 **45**
SAULA LED SW **47**
SAULA LED SN **49**
SAULA LED GS **52; 54**
ECOLINE LED EC **56**

59-78
LOW BAY LED LUMINARIES

SAULA LED LP **59**
SKY PANEL LED SL-PAN **61; 63**
LINAS OFFICE LED LO **65**
LINAS INDUSTRY LED LI **68**
LINAS INDUSTRY HORTI **70**
ELUMA LED ZL **72**
ELUMA LED ZL LITE GEN2 **75**
ELUMA LED PD **76**
ELUMA LED LE **78**

99-106
OTHER

RADIUS LED ST GEN1 **80; 82; 84, 86**
RADIUS LED ST GEN2 **88; 90; 92**
MARAMA SOL SOLAR LIGHTS **94**
SMART CITY CONROL **96**
SENSORS **99**
SUSPENSION SETS & ITEMS **100**
CERTIFICATES **101**
REFERENCES **102**
WORLDWIDE PARTNERS **106**

80-96
LED STREET LIGHTS

HUMAN-CENTRIC LIGHTING IN SCHOOLS

A Brief Guide to the Relationship between Lighting and Learning

In most places of Europe and the world, school buildings are in dire need of modernisation. In the field of lighting improvements, however, modernisation is usually, and unfortunately, understood only in relation to energy efficiency. And while efficient energy use should always be a priority, optimisation of resource use should go hand in hand with a sincere concern for human-centric lighting.

“Lighting in schools should serve the learning process, and improve the wellbeing of both pupils and teachers,” says Mr. Tomas Pukas, ECOLIGHT’s general manager: “By employing state-of-the-art LED technologies, today we can create lighting systems that optimise the efficiency of the learning process, improve the concentration of children, eliminate sources of stress and disturbance, prevent health hazards associated with poor lighting.”

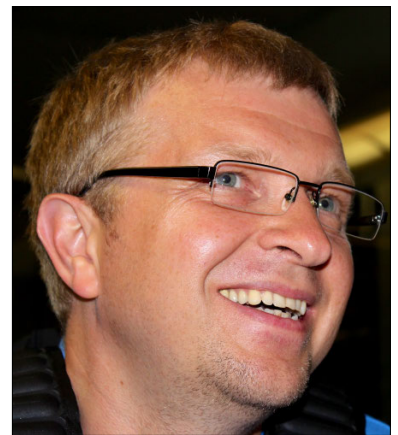

Tomas Pukas

The Criteria of Human-Centric Lighting

Contemporary discussions on appropriate lighting in offices and educational institutions revolve around the concept of human-centric lighting. In schools, human-centric lighting aims to achieve several objectives. First and foremost, the lighting system must be flexible. For example, a dynamic lighting regime should be activated for higher concentration levels when students are taking exams or are engaged in other intensive academic activities, whereas during recess a relaxing light mode is more appropriate. When installing a new lighting system, it is also crucial to think in terms of preventing excessive glare and reflections, for these unwanted lighting effects often disturb students’ concentration, and can cause stress.

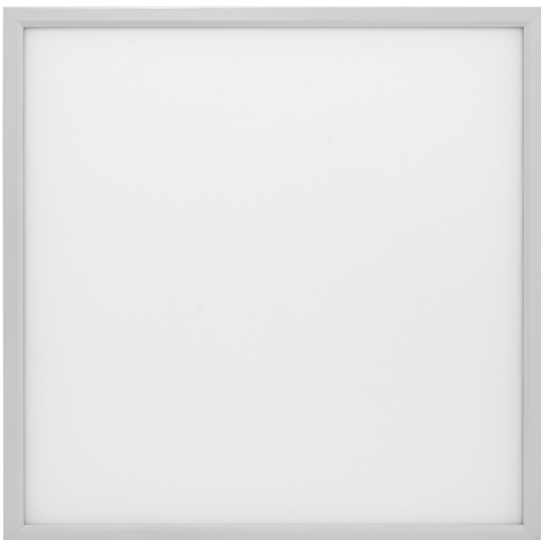

Another important point is that a lighting system must be understood in holistic terms: the school building should be thought of as one integrated system, and not just a sum of individual classroom systems. This holistic approach is essential to achieving harmony between lighting regimes and a young person’s biological rhythm.

During the course of a school day, warmer light should be gradually replaced by a cold white: luminaries that change the light’s colour temperature reduce children’s hyperactivity and have a positive effect on their ability to concentrate. A gradually shifting light colour supports our circadian rhythm (day/night rhythm), and helps optimise the biological processes in our bodies. Circadian-friendly lighting solutions help keep students concentrated until the end of classes, and, instead of getting sleepy during classes, they get tired when it is actually time to go to bed.

Luminaire Options for Schools

Market analysis shows that offices are leading the way when it comes to embracing human-centric-lighting. Business owners and office managers realise that using modern LED lighting to improve the health, concentration and energy levels of their employees is simply good business. Educational institutions are now catching up. And it is the hope of many that one day human-centric lighting will be a state-regulated requirement for all public schools.

“Taking into consideration the budgetary constraints that most public schools face, we offer schools several LED lighting options that will shortly be available at our website Camelspanels.com,” says Mr. Pukas, “In an ideal world, all schools should have LED luminaires equipped with Tunable White function which gives a wide range of correlated colour temperatures (CCT) from 2800k to 6500k.”

Scientific tests in Western European schools have shown that 3500k colour light helps students to relax, and is, therefore, suitable during recess. 5000k colour light is optimal for reading tasks. Whereas a high colour temperature of 6500k should be used during academic tests that require the highest possible concentration. A lighting system with such a wide range of correlated colour temperatures is not the cheapest solution, so, if your budget doesn't allow it, you should at least make sure the CCT range goes up to 5000k.

Troubles to Avoid

When choosing a lighting solution for a school, you should pay careful attention to several key parameters:

- *Light flickering.* Excessive light flickering can result in headaches, blurred vision, eyestrain, general fatigue and even seizures. Brand new LED luminaires may bring you handsome energy saving rewards, but the devil is always in the details. Therefore, you should always do your due diligence and ask your lighting provider about light flickering.
- *Colour Rendering Index (CRI).* This index measures a light source's ability to reflect colours accurately. CRI is measured on a scale from 1 to 100. Schools should be looking at luminaires with a high CRI: ideally CRI=100, and CRI>80 at a bare minimum.
- *Unified Glare Rating (UGR).* UGR represents a method of calculating glare from luminaires. UGR classification ranges from 5 to 40, with higher numbers indicating excessive glare. Low quality lighting solutions usually feature a high UGR which means that excessive brightness is bounced off reflective surfaces, such as whiteboards, computer screens etc. As a result, students have a hard time concentrating, and are more likely to suffer from headaches and eye trouble. Schools should be looking for LED panels with UGR<19. It's also necessary to make sure a classroom is fitted with an appropriate number of luminaires.
- *Photobiological safety standards.* An irresponsibly chosen lighting system poses a variety of health risks including potential harm to skin and eyesight. Photobiological safety should be a primary concern when selecting new luminaires for school buildings.

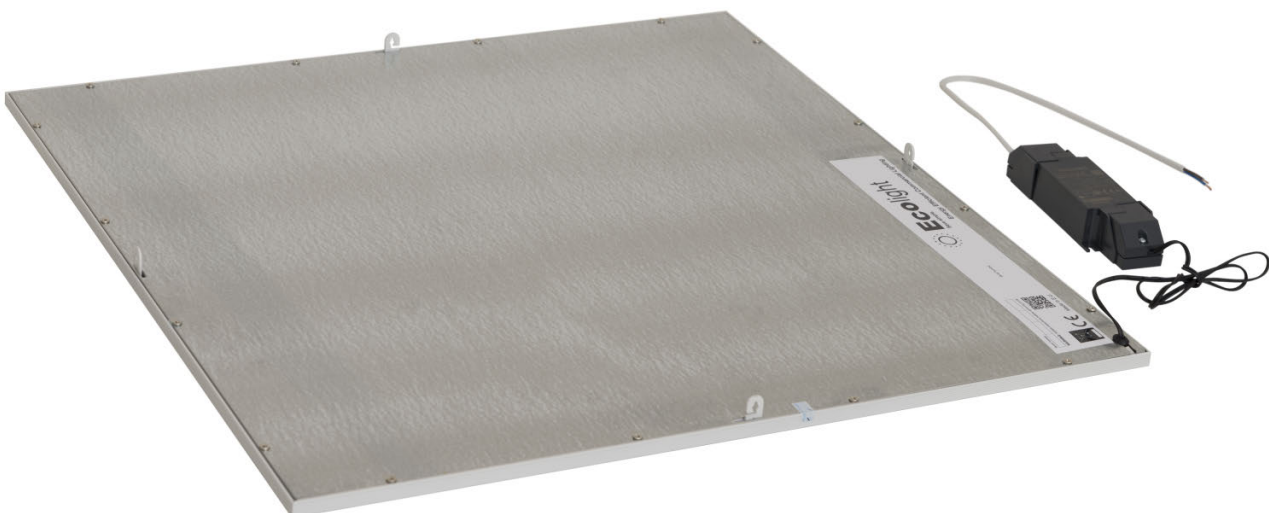

Modern LED Lights for Modern Schools

Lithuania-based LED luminaire producer ECOLIGHT offers three products for schools seeking human-centric lighting:

1. *Standard SKY PANEL LED Panels*

These extremely-reliable luminaires from ECOLIGHT feature a low glare rating (UGR<19) and do not produce excessive flickering. SKY PANEL LED luminaires are powered by high quality Philips Xitanium, Tridonic or Osram drivers. SKY PANEL LED panels represent an efficient solution to lighting challenges in the educational sector.

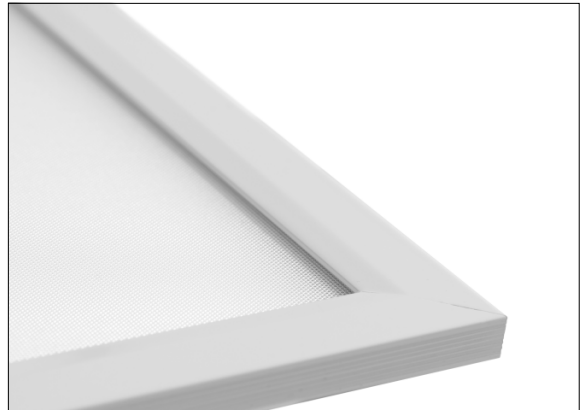

2. *SKY PANEL CTA Panels*

The name SKY PANEL CTA represents a true gem in the world of human-centric lighting. Luminaires are equipped with Tunable White function with a CCT range of 2800k-6500k. SKY PANEL CTA is designed to have a constant lumen output across the entire CCT range which facilitates light planning. SKY PANEL CTA is powered by Tridonic drivers and may have either wired (touch panel) or wireless (smart phone or remote controller) control. Users can also control light intensity. SKY PANEL CTA is the go-to option for school managers seeking the best possible learning environment for their students.



3. *Linear Lighting System LINAS OFFICE*

LINAS OFFICE is a great option for schools seeking to replace outdated, flickering and inefficient fluorescent fixtures. Delivering over 130 Lm/W efficacy, it is ultra-reliable and will be noticeably brighter than the old lighting. Upon request, LINAS OFFICE can also be equipped with the latest LED Tunable White technology, giving the user the freedom to select any colour temperature from 2700k to 6500k. Ideal for learning and working spaces, LINAS OFFICE can be either suspended (using a suspension kit) or ceiling mounted. This linear lighting fixture is also excellent at preventing shadowing, since the light produced by LINAS OFFICE is ambient, i.e., directed to walls and ceilings. LINAS OFFICE also sports a state-of-the-art wireless control system. Aside from great technical functions and characteristics, LINAS OFFICE is also a very beautiful and elegant system that is compatible with a variety of interior design concepts. For more information on LINAS OFFICE, see pages 66-67.



Schools willing to invest in any LED lighting solutions should take all necessary precautions to avoid purchasing substandard products. School managers are advised to ask their luminaire providers for specific documentation:

- 1. The pan-European certification mark ENEC (European Norms Electrical Certification).*
- 2. LM 79 test report to prove technical parameters of suggested luminaires.*
- 3. Dialux or Relux lighting simulation report to prove the system's compliance with top quality lighting standards.*

SHAKING THINGS UP: ECOLIGHT LAUNCHES LINEAR LIGHTS FOR OFFICE AND INDUSTRY

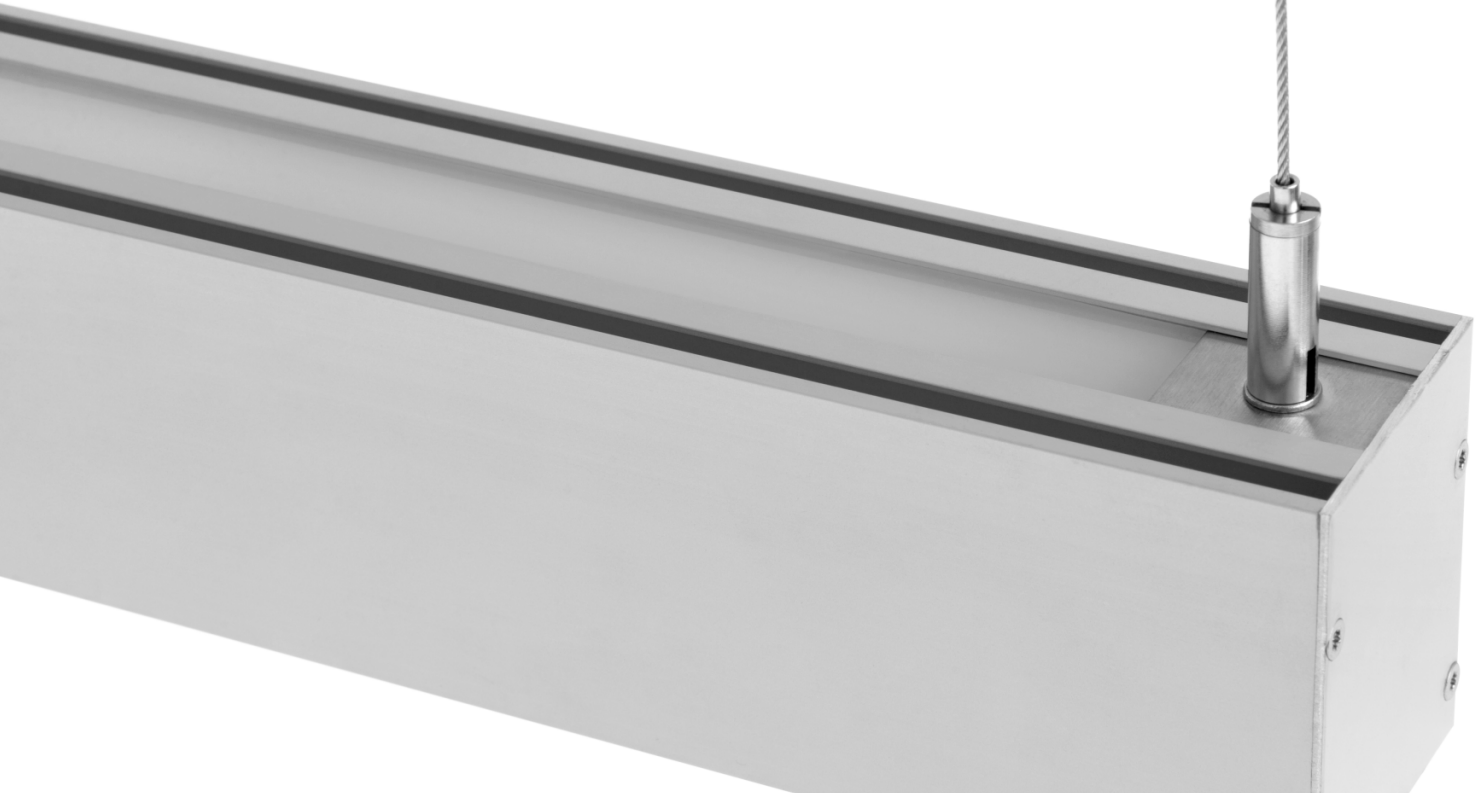

In 2019, ECOLIGHT launched its new linear light series. The LINAS series consists of two ultra-efficient luminaries: LINAS OFFICE and LINAS INDUSTRY. With this move, the company is reacting to the industry's rapidly changing demand structure.

Next-Generation Office Lighting

With LINAS OFFICE, ECOLIGHT is making an inroad into the office lighting segment. While industrial lighting has been, and will remain the company's primary forte, portfolio diversification is always a good idea. The launching of LINAS OFFICE is also a reaction to frequent requests from ECOLIGHT's distributors and partners who are involved in both industrial and office projects.

To stand out from the competition, ECOLIGHT spent over two years developing its first linear LED lighting solution for office spaces. LINAS OFFICE features tunable white technology which enables adjustable colour temperatures: from cool white to warm white. To put it simply, the employment of TW technology ensures that lighting serves human well-being in the workplace, instead of putting it in risk.

ECOLIGHT's new linear lighting fixture for office spaces is also excellent at preventing shadowing, since the light produced by LINAS OFFICE is ambient, i.e., directed to walls and ceilings. LINAS OFFICE also sports a state-of-the-art wireless control system. What's more, it has an up/down function making it an excellent choice for office projects implemented under LG7 'Lighting of Offices' guide.



Vaidas Morkūnas

“Architects and designers working with office spaces are looking for lighting fixtures that combine human health benefits, energy-efficiency and the modern aesthetics of space,” says Mr. Vaidas Morkūnas, the company’s sales manager, “And that’s what LINAS OFFICE delivers. Aside from great technical functions and characteristics, we made sure LINAS OFFICE is a truly elegant linear system that is compatible with a variety of interior design concepts.”

The New Cool in Industrial Lighting

LINAS INDUSTRY, the second product in the new series, is a new and ultra-efficient member of ECOLIGHT’s rich collection of industrial LED luminaires. In recent years, linear fixtures have become increasingly popular in warehouses. By replacing old fluorescent lights with modern linear LED lights in their warehouses, companies reduce maintenance costs, optimise on energy consumption, and improve light quality.

As is well known, one of the most common complaints regarding old warehouse lighting systems is the uneven distribution of light. With LINAS INDUSTRY, companies can eradicate this chronic issue. The linear system allows to connect luminaires in a continuous line, thereby avoiding the undesirable effects of dark spots and light gaps. A related benefit of the new system is its anti-glare properties (low UGR coefficient). The employment of LED matrix optics allows for a balanced light distribution in all directions.

Another noteworthy advantage of LINAS INDUSTRY is a remarkably quick and easy installation process (through wiring). In the most economically advanced markets, lengthy installation works can be



very expensive. In this sense, LINAS OFFICE is a true life saver. The system allows companies to reap the benefits of savings even before they switch the lights on.

Just like LINAS OFFICE, LINAS INDUSTRY features a smart wireless control system. LINAS INDUSTRY was made for modern warehouses seeking brighter, whiter, smarter and more efficient lighting replacements to achieve energy savings, and a pleasant working environment for staff.

Important Investment

“We don’t see LINAS OFFICE and LINAS INDUSTRY as niche products, in fact we are already facing a huge wave of interest from our clients,” says Mr. Morkūnas, “This wave of interest didn’t catch us off guard, however, as we are already making important investments in new production capacities that will allow us to satisfy growing demand.”

At the end of 2018, ECOLIGHT commenced the construction of a new aluminum workshop where aluminum profile luminaires, including the LINAS series, will be produced on a mass scale.

Turn to pages 66-69 for technical specifications of LINAS OFFICE and LINAS INDUSTRY.

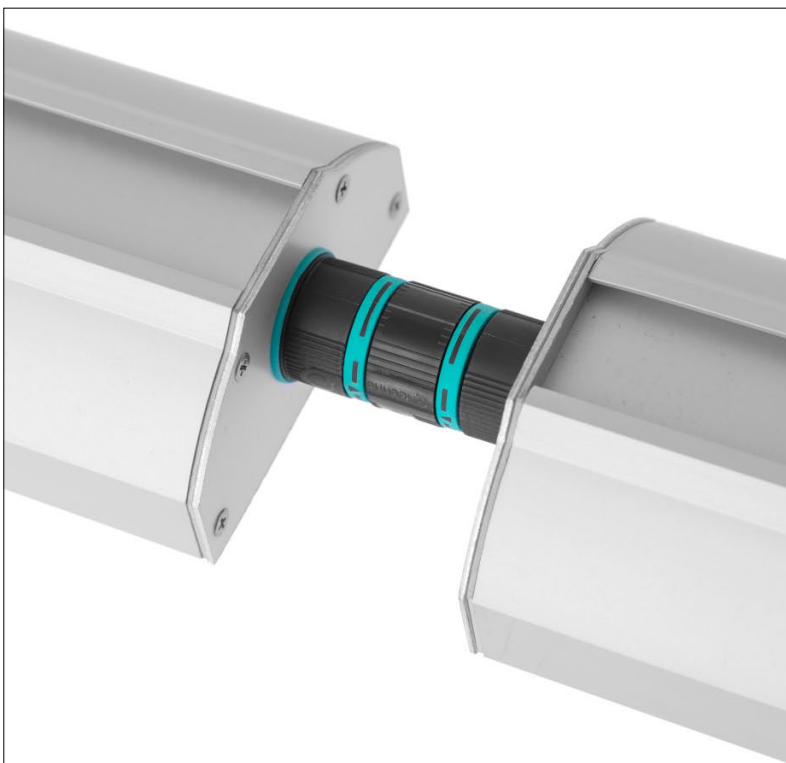

WE MADE A ROBOT THAT IS SMARTER THAN US

Meet ECOLIGHT's First Self-Learning Solar-Power Luminaire

Having launched its first solar LED street lights in 2017, today ECOLIGHT is working on the first smart solar solution based on IoT (Internet of things) technology. Meet MARAMA SOL, ECOLIGHT's first self-learning autonomous outdoor LED lighting system powered by solar panels. The final version of this product is scheduled to reach the market in 2020.

Solar is Here to Say

Smart solar solutions are rapidly growing in demand across the world. In remote off-grid areas such as deserts and jungles, such systems represent the only viable solution to lighting needs. In modern cities, smart solar LED street lights are embraced as the technology of the future that combines environmental, economical, and smart-control benefits. Regulators in Europe, China, and North America are pushing for the adoption of innovative solar technologies, and will continue to do so with increasing pressure. Reacting to growing demand, ECOLIGHT engineers are working hard to be on the right side of technological progress.

Internet of Things

The main challenge of solar light technology is that energy production can be very limited in geographical areas with limited sunshine hours. Such areas include northern regions of North America, Europe, and Asia. Powered by IoT technology, MARAMA SOL features an innovative energy management system that can solve this challenge. The control system consists of three main elements:

- Antenna for communication between luminaire and the server;
- Cloud server with a database and special software for data analysis;
- User interface (computer or smart phone).



The system is programmed to analyse historical weather data, and import weather forecasts. By analysing past and future weather data and matching this data with its current energy production coefficients, the system programs the most efficient lighting regime under the current circumstances. In essence, MARAMA SOL is a self-learning machine that always works to optimise the balance between energy production and energy use for lighting. The lighting regime of MARAMA SOL LED street lights can be monitored and controlled by public or private users through a web platform.

From the Metropolis to the Jungle

In the on-grid city version, MARAMA SOL produces electric energy during daytime and sells it to electric utility companies. During dark hours, it uses cheaper energy imported from the same companies. This means that the system may have a very clear and objective pay-off formula.

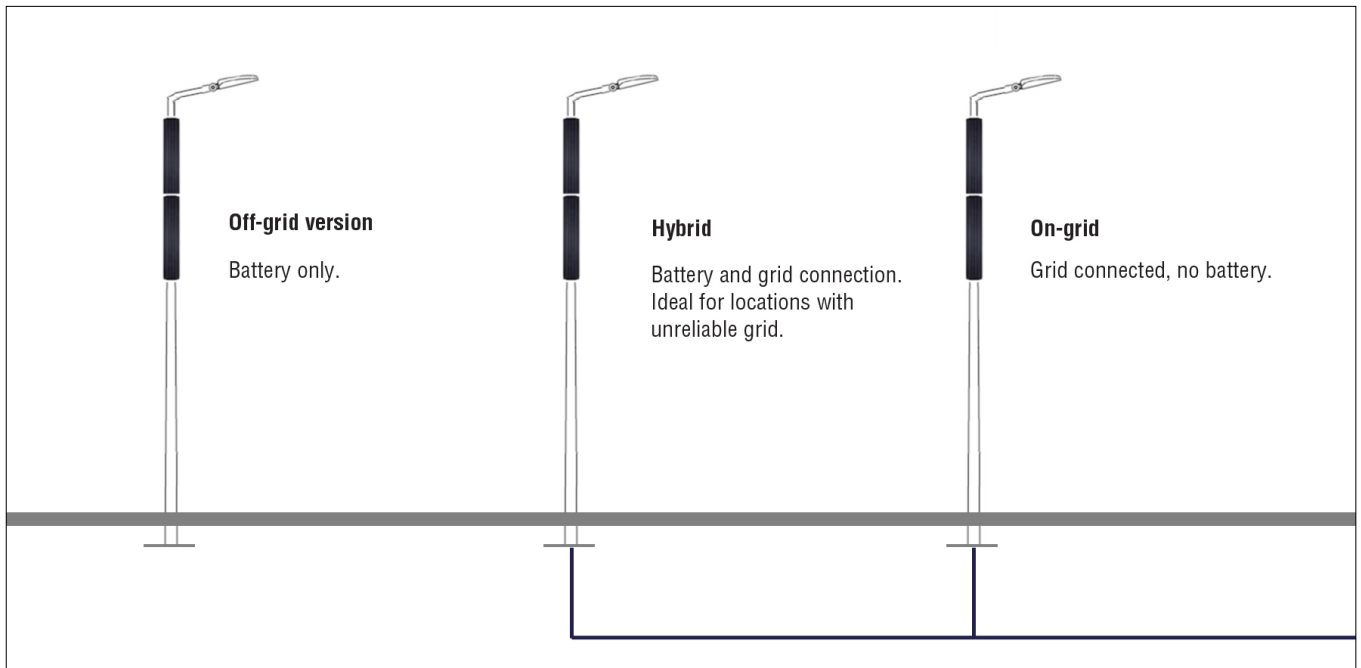

MARAMA SOL is also scheduled to have off-grid and hybrid versions. The off-grid version is meant for locations where deployment of traditional lamps in a wired network is impossible or too expensive. The hybrid version is meant for areas where electricity is accessible, but electric supply is unreliable or unstable. MARAMA SOL is a universal solution that is applicable anywhere from the jungle to the metropolis.

Key features:

- MARAMA SOL luminaries are compact, easy to transport, easy to assemble, and easy to transform or upgrade using a system of modular components.
- Because it is an autonomous, self-managing and self-learning system, it requires little to no maintenance.
- MARAMA SOL functions on light-on-demand principle, turning light on when necessary, changing light intensity when appropriate, and optimising energy consumption when possible.
- In order to strike the perfect balance between energy production and energy use, it uses complex algorithms

that account for energy production coefficients, geographic location, season, historical weather data and the most up-to-date weather forecasts.

- The users have the option to intervene and change the system's plan. The lighting regime can be altered by just a couple clicks on a smartphone app.
- MARAMA SOL luminaries can work in teams by sharing data.
- Photovoltaic panels are mounted vertically which optimises the collection of solar power and prevents the gathering of dirt, snow and bird droppings.

INNOVATING WITH ACADEMIC PARTNERS

Young Mechanics and Developers Take on Marama Sol project

We live in a science-shaped world where innovators are kings. Tech companies are leading the way in this era of constant innovations. It would be naïve, however, to think that significant technological breakthroughs could happen without the scientific foundations laid out by the great minds working in academic institutions. This is a fact known to all great tech companies who do their best to draw from the pool of scientific knowledge.

Therefore, when we set out to create our big innovation – the self-learning solar-power LED luminaire – we knew we needed to draw on external intellectual expertise. It was not that we didn't have enough intellectual power in our in-house team of engineers and IT professionals. We simply felt that we had to mix our internal expertise with fresh intellectual inputs from the leading applied science university in our region. With this purpose in mind, we approached Demola.

Bringing Business and Science Together

To those of you who haven't heard about it, Demola is an international innovation challenge platform that brings together leading companies and bright students to create a better future for everyone. During a Demola workshop, a multidisciplinary team of university students and company's experts work together in an innovation challenge set by the company.

Over 50 universities worldwide participate in the program. And numerous global brands have already benefited from innovating in this way. The list of companies who have used Demola to partner up with academic institutions includes Vodafone, Intel, Nokia, Valmet, and many others.



Grooming Young Talents

After we had reached an agreement with Demola, our project managers teamed up with the brightest students from Vilnius Gediminas Technical University. The project was undertaken with two groups of students that were presented with two different objectives, and were supervised by two different project managers from ECOLIGHT.

The Mechanics

A group of promising mechanics students were presented with a challenge to improve our universal solution for



integrating cylindrical solar panels. The key advantage of the MARAMA SOL system is its LEGO-type modifiability. Users can choose to add whichever number of cylindrical solar panels or decorative panels to create the luminaire they want.

Clients can use this system to build street lights (up to 8 meters in height), park lights (4-6 meters in height), or miniature footway lights (2 meters in height). Moreover, home owners can employ the system to add special decorative panels to create unique light effects for their home yards. For all this to work, however, we needed a universally applicable solution for connecting individual panels to each other.

This team of students was supervised by Vaidas Kutkaitis, ECOLIGHT's technical director. "We began the workshop with a clear concept in mind and provided the students with guidelines for implementing this concept," says Mr. Kutkaitis: "Employing the scientific methods of experimentation and trial and error, the students achieved great results and helped us get closer to developing the perfect mechanical solution."

The Developers

The second group was made of information technology students. These young developers and algorithm designers were presented with a task to develop an algorithm, and to refine the MARAMA SOL user interface for remote energy management. "Getting fresh insights from top students in the field really helped us out," says Rytis Petrauskas, ECOLIGHT's head IT manager, who supervised the young developers: "It takes a lot of testing, experimenting and adjusting to develop a sophisticated algorithm that encompasses sunshine levels, weather forecasts, energy balances, battery levels, etc."

Mr. Petrauskas recounted that IT students surprised him with their ingenuity on numerous occasions: "One of their sharpest innovative concepts was an artificial intelligence solution that allows the luminaire to tell the user if there's a need for extra solar panels to optimise energy production."

Building on the algorithm structure developed during the DEMOLA workshop, ECOLOGHT's in-house developers are now completing the project. Thanks to this algorithm, MARAMA SOL will function as a self-learning machine that can optimise energy production and energy use to provide sufficient lighting even in the most sunless places of the world.



The Path to Originality

Both mechanics and developers worked under one iron rule: no one was allowed to analyse the solutions adopted by ECOLIGHT's competitors. "While self-learning solar luminaries are a new technology, we are not the only company that is making strides forward," explains Tomas Pukas, the company's general manager: "By looking at competing technological solutions one risks to block the creative process and may unconsciously end up copying those solutions."

By adopting this rule, we are making sure that our solar lighting innovation is totally original. Asked to comment how MARAMA SOL differs from competing lighting innovations, Mr. Pukas made his point by invoking a famous fictional character: "The other players are marketing their smart solar lights as luxury products that are only affordable to the richest of the rich, whereas we want to play the role of Robin Hood and make this innovation accessible to the wider segments of the market, including the public sector."

From the entire team of ECOLIGHT, a big thank you goes to the young mechanics and developers who made MARAMA SOL better. Thank you Augustinas Čečys, Augustas Bastys, Denielius Šavrukovas, Ugnė Latvėnaitė and Hetvildas Petkūnas.



THE MOST INTERESTING PROJECTS IN YEAR 2019



Year 2019 was particularly successful for ECOLIGHT. Entering 2019 with a rising spirit and such optimism, we felt, to some extent, that success awaited us. And it really did!

First of all it was in that year that many famous companies chose ECOLIGHT luminaries. At the same time, we watched the company's turnover grow and to our delight, in 2019, it grew by more than 25 percent!

By the way, our partners abroad have strengthened, and we have received many ongoing projects. The continuity of work is extremely important to us, because it means that customers like the products we provide. After all, they choose our services again and again, which is the best rating for us!



ECOLIGHT installers at Kessler+Co site, Germany

GERMANY

KESSLER + Co

Kessler + Co. is a leading manufacturer of drive components for heavy mobile equipment. They design and manufacture planetary axles, wheel drives and gearboxes for a variety of purposes. Kessler + Co, with a production area of 90,000 sq. M. Meters, produces about 45,000 axles and gearboxes per year, and has an annual turnover of about 400 million. EUR.

More than 1000 pcs of LUMINA LED LN and ELUMINA LED ZL lights were installed in a newly built Kessler+Co factory in Abtsgmünd, Germany. This project was very important to ECOLIGHT because we were providing a full service for the first time- not only the luminaries but also the electrical installation. To get this job we had to get all the necessary certificates and permits authorising to do electrical installations in Germany. Project was implemented together with our partner in Germany - RMBH GmbH.



Ralph Müller / RMBH GmbH (Germany)



Jože Erjavec / ERCO I d.o.o. (Slovenia)

SLOVENIA

HIDRIA

Hidria boasts a tradition of more than 50 years of manufacturing solutions for the automotive and industrial sectors. Although in 1955 Cars could hardly be found on Slovenian roads, Hidria had a vision and was brave enough to start producing car plugs. Since then, the path to success has been paved with the knowledge, courage and visions of the people who turned a small Slovenian company into a progressive global corporation. Today, Hidria is one of the most innovative car companies in Europe.

A wide range of ECOLIGHT lights, including SAULA LED LN, LUMINA LD LN, ELUMA LED ZL, ECOLINE LED EC and RADIUS LED ST were installed in a Hidria factory in Spodnja Idrija, Slovenia. Around 1200 luminaries were installed in total. This project was implemented in 2020 February - March by our partner in Slovenia - ERCO I d.o.o.



SLOVENIA-CROATIA BORDER CROSSING STATIONS

All border stations between Slovenia and Croatia were upgraded using LUMINA LED LN luminaries equipped with PHILIPS intelligent light control system EasyAir. This project was implemented in 2020 March - April by our partner in Slovenia - ERCO I d.o.o.

SERBIA

PEŠTAN

The private company Peštan is a leader in the Balkans in the production and distribution of polymer products and solutions. Peštan operates in more than 70 countries through a global network of agents and distributors.

Around 200 pcs of LUMINA LED LN, ELUMA LED ZL, SAULA LED LN and SKY PANEL lights were installed in Peštan factory in Arandželovac town, Serbia.



TYGAR TIRES (MICHELIN)

Tigar Tyres is a Serbian tire manufacturing company based in Pirot, eastern Serbia. Since 2007, it is owned by the world's second largest tire manufacturer Michelin. As of April 2016, the company had around 3,000 employees.

More than 200 pcs of SAULA LED LN, ELUMA LED ZL and SKY PANEL light were installed in Tyger Tyres plant in Pirot, Serbia. Some of these lights are in XT modification and are installed in very hot environments.



Both projects were implemented by our partner in Slovenia- ERCO I d.o.o.



LITHUANIA

MULTIFUNCTIONAL CAR PARK P4 AT VILNIUS AIRPORT

The newly built multifunctional car parking (P4) at the Vilnius Airport was lighted with a mixture of ELUMA LED LE, RADIUS LED ST, SKY PANEL SL and LINAS OFFICE LO lights from ECOLIGHT. ELUMA MED LE were used in the parking area, while RADIUS LED ST was used in an open parking on the roof. SKY PANEL and LINAS OFFICE were used in the rest of the building - common and office areas.

POLAND

BLACK RED WHITE PREMISES IN BIŁGORAJ, POLAND

Black Red White S.A. is the biggest polish manufacturer of traditional and new furniture systems, home and office furniture. It is consisted of 17 production plants which employ over 6000 people.

More than 1700 pcs of SAULA LED LN, LUMINA LED LN, ELUMA LED ZL and ECOLINE LED EC lights were installed in the Black Red White premises in Biłgoraj. We are utterly delighted that this is already our second project with this customer!

This project was implemented in 2020 March - April by our partner in Poland - INS Lighting.



Adam Dawidowski / INS Lighting (Poland)

BUSINESS IS JUST ONE SIDE OF THE COIN

The Other is Grilling and Chilling at ECOLIGHT Summer Camp



Being a part of ECOLIGHT family of companies transcends business. It is a business-to-business network that has evolved into a human to human community. We learn from each other. We have fun together. We share each other's woes. And let's be honest about it: we spend way more time together- both offline and online- than our spouses would like us to. But hey, "It's work, baby"

Our last major gathering took place in a wonderful castle in Norviliškės, in eastern Lithuania, in August 2019 (Thursday the 4th to Friday the 5th). Fifty people from six different countries- Lithuania, Poland, Latvia, Czechia, Italy, France- attended this event. We called it Signify-Ecolight Summer Camp 2019. Sounds serious, right? That's what we were going for. Before we get to the serious part, however, let's reflect on the camp's most memorable highlights.



A special celebration

In 2019, the ECOLIGHT SUMMER CAMP stood out from previous events. It took place in an astonishing castle near the Belarusian border, which is known for its interesting and rich history, and its “Be2gether” festivals. There were a lot of interesting activities, a lot of smiles, everything seemed really extraordinary. But in very truth, 2019 was far from being an ordinary year! Exactly ten years from now, ECOLIGHT was born and we wanted to celebrate this important anniversary in an unforgettable beautiful environment with those special people who made it all possible.



There is only one step between hard work and having fun.

Like each year this event manoeuvres between fun and hard work. That’s why SUMMER CAMP lasts two entire days.

On the first day there was a conference during which we, as ECOLIGHT and our partners from SIGNIFY presented novelties which are coming to the market- new products, new technologies, etc. Afterwards we had a sales discussion and shares experiences from different countries. In the evening we attended a reality show called “THE SOVIET BUNKER”. It was an extremely interesting experience, especially for our foreign friends.





Top Achievers of 2019

This unforgettable anniversary was also an excellent occasion to honour our top-achieving country partners.

And here are the winners:

Most promising distributor

Mr. Jože Erjavec
ERCO I d.o.o. (Slovenia)

Best Sales Improvement

Mr. Adam Dawidowski
INS Ewa Porzych (Poland)

Best Sales Performance

Mr. Darius Valečka
UAB "USI International" (Lithuania)

Order of the year

Mr. Ralph Müller
RMBH GmbH (Germany)

Best Sales Improvement

Mr. Václav Šlambora
NBB Bohemia s.r.o. (Czech Republic)

Support & Services Award

Mr. Sławomir Henryk Guss
Signify Poland Sp. z.o.o. (Poland)



More friends than co-workers

Informal communication helps us to form a community in which we are not only co-workers but also friends. We meet several times a year: at exhibitions, at SUMMER CAMPS and even during informal visits. This connection we create improves our business, makes it easier to solve problems, and simply makes us happy!

We asked Tomas Pukas, the CEO of ECOLIGHT, what one word he would use to describe his impressions of the event and he instantly replied, "Incredible".

This ECOLIGHT-SIGNIFY event organised every year became a pleasant tradition, which strengthens our ties and makes us a real team. Even though, this year SUMMER CAMP will be postponed to year 2021 because of the COVID-19 situation, we should not be disappointed. It simply means that in 2021 we will have twice as much fun to make up for one gap year!

The second day was reserved for informal communication and was all about having fun! After a work-filled day on Thursday, we had a fun filled day on Friday. As every time during this event, our family split into two groups: while the first group went on a kayaking trip, the other one went sightseeing. After spending a truly rich day, we rendezvoused again in the castle and had a special dinner, complemented by a rock band and... a flash dance performed by ECOLIGHT employees!



Lessons Learned

You know how they say that underserved fun is not that fun? Well, maybe nobody really says that, but that's the motto we go by at ECOLIGHT. That's why, before all the entertainment on Thursday night and Friday, we put in a hard day's work on Thursday when we had our full day training session "Challenges and best practices of selling ECOLIGHT lights in different countries".

After all presentations and discussion sessions had been wrapped up, we summarised our insights into the four 'Iron laws' of doing great sales work:



Work Smarter, Not Harder

In most markets, the right strategy for selling ECOLIGHT lights is to focus on mid-size projects and clients. The small ones don't make sense financially, the big ones are often too difficult since the big sharks can always screw you up. Don't try to sell too soon, give trial luminaries first. Don't sell the product, sell the solution which is something only a true lighting professional can do, and a mere salesperson cannot.



Think Outside the Box

If the segments you are targeting are not receptive to the luminaries you are offering, you can change both. You just need to get out of your comfort zone. You can target other segments, and you can ask ECOLIGHT to manufacture luminaries that fit your client needs better.



Exploit ECOLIGHT

There are many companies in your market that are selling cheap Chinese products. They can't get any help from the manufacturer. You can! You can ask us for free-return samples to make pilot installations. You can negotiate special payment terms. You can reduce your risk by using ECOLIGHT credit insurance. You can reduce your marketing costs by referring your clients to our website in your local language. Heck, you can even ask our team of installers to come over and do the heavy work for you.



Talk to Each Other

There are many ways in which ECOLIGHT distributors can co-operate among themselves. You can seek advice, documentation, or even purchase products from each other when it makes sense logistically compared to sourcing directly from Lithuania. We have set up a number of online venues for all ECOLIGHT-related discussions and information sharing including ECOLIGHT forum, ECOLIGHT Viber groups, and ECOLIGHT Dropbox folder.

CELEBRATING THE SOCIAL RESPONSIBILITY AWARD

INSIGHTS

ECOLIGHT walked into the year 2019 with high spirits and bags full of optimism. The company has just won the annual award for the most socially responsible company in Kaunas region. The award ceremony took place on the 13th of December 2018, and was co-hosted by Kaunas region municipality and Kaunas chamber of commerce, industry and crafts. The award commission decided that no other company in the region had done more for the social betterment of disadvantaged people in 2018 than ECOLIGHT.

Employer of People with Disabilities

Now, a quick reminder to those readers who aren't familiar with our organisation: since 2011, ECOLIGHT has been operating as a social enterprise. As a company with a status of a social enterprise, we are committed to employing people with disabilities. As of the moment of writing, sixty percent of ECOLIGHT employees are people with various degrees of disability.

“Being recognised as the most socially responsible company in the region is a real milestone for our young company,” says Mr. Dainius Bernotavičius, the co-owner of ECOLIGHT, “The award celebrates our continuous effort to strengthen our local community by employing disadvantaged individuals who often face discrimination elsewhere.”

Mr. Bernotavičius was quick to emphasise, however, that a mere fact of employing people with disabilities should not give any company a sense of entitlement. What matters is how you operate on a daily basis to empower your employees. And this is where ECOLIGHT aims to be a standard-setter.

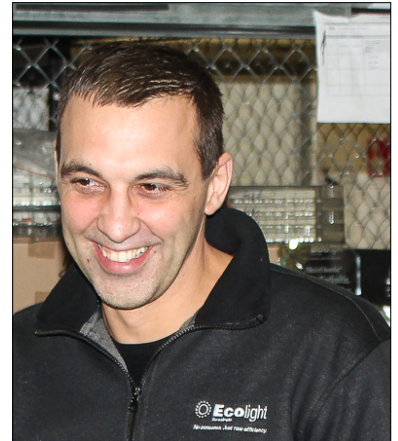

Dainius Bernotavičius



Workplace Improvements

All ECOLIGHT workplace facilities are adjusted for people with physical disabilities. The company is also employing LEAN methodology to improve working conditions for each member of our workforce. Workplace improvements that are continuously implemented in the factory floor depend to no small extent on the specific physical limitations that are unique to different individuals. This way every employee is empowered to do his or her best work, which subsequently translates to better results of overall factory productivity and higher employee salaries.



Another important sphere of social responsibility is the inclusion of employees in the process of decision-making. Many scientific studies have shown that people with disabilities are more prone to depression, they show less initiative, and are less inclined to offer their perspective on issues. Therefore, it is important to take pro-active measures to encourage people with disabilities to speak their mind, and offer their insights on how processes can be improved. To this end, a few years ago ECOLIGHT introduced the KAIZEN system which encourages employees to participate in

generating new ideas regarding work organisation and process optimisation. For every implemented idea employees receive financial bonuses.

After Work

Social responsibility does not begin at 8.00 am, and it doesn't end at 17.00 pm. "Our factory is located in a tiny provincial town of Lithuania, which means that people don't have a lot of options for quality leisure time: no cinema theatres, no concert halls, no good-quality gyms," explains Mr. Bernotavičius, "Having a physical disability narrows your options even further".



To improve the social life of employees, ECOLIGHT offers a range of activities that can be grouped in three different brackets: internal events (team-building parties and events), opt-in activities (basketball tournaments, swimming pool, etc.), and travelling (around Lithuania and to foreign countries).

Employees are especially thrilled about visiting other countries where they also meet up with the company's client companies and their employees. The benefits of these journeys cannot be reduced to the typical pleasures of tourism. It's also about realising that people in different countries are very appreciative of the product we produce back home, it gives our employees a new sense of purpose.

Looking Forward

In the words of Mr. Bernotavičius, "Winning a social responsibility award was a great symbolic achievement for us, but we must not sleep on our laurels."

ECOLIGHT has recently started the construction of two new buildings: a luminaire testing laboratory, and a new aluminium workshop. The company's management has made it a top priority to making sure these buildings meet the state-of-the-art standards for accessibility to disabled and physically handicapped employees and visitors.



ECOLIGHT TRADEMARK PROTECTED BY EU AUTHORITIES

Interviewed by Justina Pukaitė

ECOLIGHT has been registering its trademark in Lithuania since 2011. As its sales abroad grew, at the end of 2016 the company submitted the “ECOLIGHT” registration to the EU Intellectual Property Office too. A year later, ECOLIGHT received a protest from an Italian company with a similar name “Consortio Ecolight”.



We questioned Tomas Pukas, the CEO of ECOLIGHT, and Irmantas Balsys, a lawyer representing the company, for some interesting details.

Tomas, why was it so important to preserve this particular brand? After all, it would have been much easier to give up and create a new one.

In fact, yes, most patent attorneys and lawyers interviewed in Lithuania considered this dispute hopeless and advised us to change the brand and to not waste money. However, we did not want to give up, since the brand „ECOLIGHT” was already well-known in its field. During our years of operation, we have participated in almost 30 international exhibitions with the ECOLIGHT brand. We did not want to retreat so easily without a fight. Exports account for about 70% of our revenue structure, which is why this dispute has been so important to us.



What arguments did the company use in the fight for their trademark rights?

ECOLIGHT argued that the Italian company had not actively used the brand in the EU recently. Besides, even if the Italian company had registered the company in the same class as we did, it was not a luminaire manufacturer, but it was engaged in the recycling of old luminaries. The Italians did not have any products, they provided services.

How did you manage to defend your rights to the ECOLIGHT brand? There must have been a serious fight?

The first legal disputes were hopelessly lost — all of our arguments were drastically rejected. However, we decided to appeal, and, to our great delight, the dispute was returned for reconsideration. It was not easy to re-argue our position to the institution that had already rejected our documents once, however the second time was a success and the Italians no longer disputed the situation. We have defended the rights to our brand, which has been grown for many years.

Controversies like that are quite frequent.

When Irmantas was asked what he could recommend to Lithuanian companies in such situations, he had one advice to give: Lithuanian companies that have a strong brand, should not be afraid to defend their rights in foreign markets, even if they face similar brands or fail once. For instance, company ECOLIGHT consistently substantiated its arguments, the growth of their brand awareness in foreign markets and did not stop after the first failure. The strong backbone and self-confidence of the client contributed the most to the successful outcome of the dispute.

EUROPOS SAJUNGOS INTELEKTINĖS NUOSAVYBĖS TARNYBA
EUROPEAN UNION INTELLECTUAL PROPERTY OFFICE

210 016150864
220 12/12/2016
400 22/12/2016
151 12/01/2020
450 14/01/2020
186 12/12/2026
541 ECOLIGHT Save simple.
521 0
546

531 1.3.2
26.1.24
26.1.96

732 ELEKTROS TAUPYMO SPRENDIMAI, UAB
DIDLAUKIO G. 94-22
08332 VILNIUS
LT

270 LT EN
350 LT - (a) 65035 - (c) 05/04/2011
511

IT - 11
Impianti per illuminazione.
LT - 42
Servizi di scienza e tecnologia.
LV - 11
Apģaismes ierīces.
LV - 42
Zinātniskie un tehnoloģiskie pakalpojumi.
LT - 11
Apģvietimo ierģināji.
LT - 42
Mekslo ir tehnoloģiju paslaugas.
HR - 11
Rasvjetne instalacije.
HR - 42
Usluge znanosti i tehnologije.
HU - 11
Világítástechnikai berendezések.
HU - 42
Tudományos és technológiai szolgáltatások.
HU - 11
Származási területek.
HT - 42
Serviszi yjifitici u teknoloji.
NL - 11
Verlichtingsinstallaties.
NL - 42
Wetenschappelijke en technologische diensten.
PL - 11
Instalacje oświetleniowe.
PL - 42
Usługi naukowe i technologiczne.
PT - 11
Instalações de iluminação.
PT - 42
Serviços de ciência e tecnologia.
RO - 11
Instalații de iluminat.
RO - 42
Servicii în domeniul științei și tehnologiei.
SK - 11
Osvetľovacie zariadenia.
SK - 42
Vedecké a technologické služby.
SI - 11
Napeljave za osvetljevanje.
SI - 42
Znanstvene in tehnološke storitve.
FI - 11
Valvontalähteiden asennukset.
FI - 42
Tieteelliset ja teknologiset palvelut.
EL - 11
Ευκαταστάσεις φωτισμού.
EL - 42
Επιστημονικές και τεχνολογικές υπηρεσίες.
EN - 11
Lighting installations.
EN - 42
Science and technology services.
FR - 11
Installations d'éclairage.
FR - 42
Services scientifiques et technologiques.

No 016150864 1/1

EU IPO
EUROPEAN UNION
INTELLECTUAL PROPERTY OFFICE

EUROPOS SAJUNGOS INTELEKTINĖS NUOSAVYBĖS
TARNYBA
REGISTRACIJOS PAŽYMĖJIMAS

Šis registracijos pažymėjimas išduodamas toliau nurodytam įregistruotam Europos Sąjungos prekių ženklui. Europos Sąjungos prekių ženklų registre padaryti atitinkami įrašai.

EUROPEAN UNION INTELLECTUAL PROPERTY
OFFICE
CERTIFICATE OF REGISTRATION

This Certificate of Registration is hereby issued for the European Union trade mark identified below. The corresponding entries have been recorded in the Register of European Union trade marks.

Registruota / Registered 12/01/2020
No 016150864

Tarnybos vykdomasis direktorius / The Executive Director
Christian Archambeau

www.euipo.europa.eu

PRODUCT CATALOGUE

LED lighting for industrial and public applications

All information provided in this catalogue is approximate and meant for guidance only. All information is subject to alteration and modification.

Goods supplied may vary in detail from the illustrations, drawing and descriptions as a result of improvements.

No part of this Catalogue may be reproduced or modified without the written consent of UAB "Elektros taupymo sprendimai".

All text, illustrations and images are the property of UAB "Elektros taupymo sprendimai".

THE ENERGY-EFFICIENT HIGH BAY LED LUMINAIRE

Models: LM-EN4/4F/6000, LM-EN5/6F/6000



A POWERHOUSE FOR HARD INDUSTRY

The LUMINA LED LM luminaire is a true-life saver for hard industries. These heavy-duty luminaires are equipped with Philips Fortimo Fast Flex LED modules and Philips Xitanium Outdoor drivers. Originally, Philips developed these technologies for outdoor lighting. Employed indoors, these technologies provide LUMINA LED LM with unparalleled power, reliability and longevity that hard industries crave for.

LED LUMINA LM will give you more than 100.000 hours of excellent performance. What's more, this hard-working luminaire is integrated with a smart overheat prevention system, and can also withstand over-voltages exceeding 10kV. The system features easy double-point mounting for a stress-free installation.

Good to know: This is an excellent solution for facilities with very high ceilings of up to 20 meters.

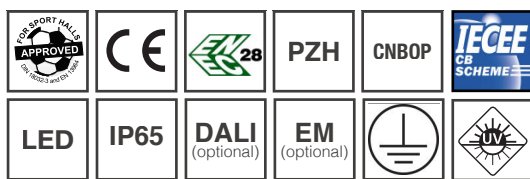
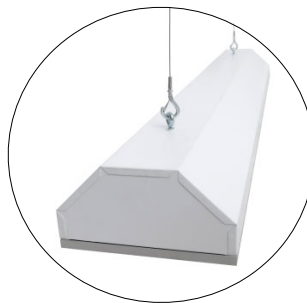
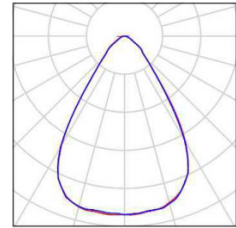

GENERAL TECHNICAL SPECIFICATIONS		Number of LED modules	4 or 6
Supply Voltage	220-240V AC	Lamp family code	Philips FastFlex LED Module
Supply Frequency	50-60 Hz	Lamp color K	3000, 4000 or 5700
RFI Suppression	EN 55015 / CISPR 15	Colour Rendering Index	>70 or > 80
Immunity	EN 61547	Useful life L70B50 at Ta 40 °C	100.000 h
Harmonics	EN 6100-3-2	Driver /power unit/	PHILIPS XITANIUM
Operating Temperature*	-35 - +40 °C	Flickering	IEEE 1789
Storage Temperature	-40 - +60 °C	Power factor (full load at 230V)	> 0.90
Housing material	0.8 mm powder coated steel	Dimmable	Optional
Enclosure Rating	IP65	Emergency pack	Optional
Lid material	PMMA, Polycarbonate or Tempered Glass	System Wattage	up to 180W
Cable gland	PG 13.5 or STUCCHI (3-pole) fast plug optional	System efficacy at max luminous flux	up to 143 lm/W
Impact Resistance	IK07 or IK09	System luminous flux (max)	up to 25.740 lm

* Only with Xtr drivers. Otherwise from -20 to +40 °C. Operating Temperature limitations for P/S/EM options see in next page.

GENERAL TECHNICAL SPECIFICATIONS

EAN	Ref.	Wattage	System efficacy at max luminous flux	System luminous flux (max)	Available Options	Dimensions (mm)*				Optimum Working Height
						D	L	W	H	
4772049000186	LM-EN4/4F/6000	80W	150 lm/W	12.000 lm	S/P/EM/SP/IN/1F/3F	890	1210	245	135	up to 10 m
		100W	147 lm/W	14.700 lm						up to 15 m
		130W	143 lm/W	18.590 lm						up to 15 m
4772049000193	LM-EN5/6F/6000	180W	143 lm/W	25.740 lm		1190	1510	245	135	up to 20 m

* without sensor

EAN	Additional options	Ref.
Multiple selection	PIR Sensor (-10/-30 - +35 °C)	S
Multiple selection	PIR and Light Sensor (-10/-30 - +35 °C)	P
4772049001008	Emergency Pack 3h (1h optional)	EM
4772049001596	Protective Sport Cage	SP
4772049001022	INOX body upgrade	IN
4772049003927	1 phase wiring cables for through-wiring	1F
4772049003934	3 phase wiring cables for through-wiring	3F

* There is a possibility to order ready-to-use luminaries with desired length of cable installed.

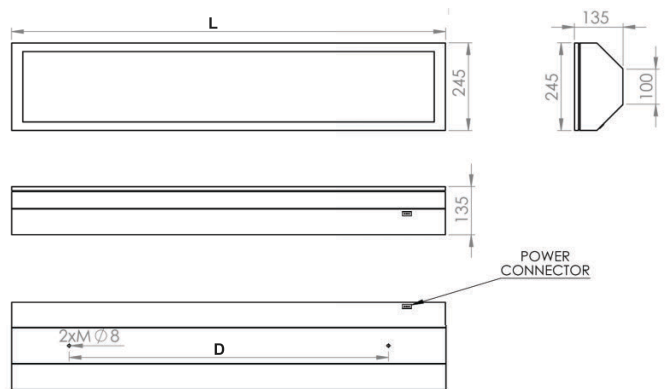

EMERGENCY PACKS

TrustSight PRO 45-300V NiMH	3 hour
Operating Temperature	0 - +40 °C



ISO 9001 - ISO 14001
OHSAS 18001

BUREAU VERITAS
Certification



Ecolight™
Save simple.

ELEKTROS TAUPYMO SPRENDIMAI, UAB
Moletu str. 13, Didzioji Riese (PC "Link Moletu"), Vilnius distr. 14028, Lithuania
Liepu str. 15, Linksmakainis, Kaunas distr. 53290, Lithuania
E: info@ecolight.lt T: +370 5 2328207 F: +370 5 2784262
W: www.ecolight.lt, www.ecolight-lights.co.uk

THE ENERGY-EFFICIENT HIGH BAY LED LUMINAIRE

Models: LD-EN4/2L/4400, LD-EN4/2L/8000,
LD-EN4/2L/12000

ANTI-GLARE SOLUTION FOR INDUSTRIAL LIGHTING

The LUMINA LED LD luminaire is the perfect lighting solution for industries based on detailed manual tasks. This anti-glare luminaire is unique in terms of the position of the LED modules inside the system. The modules are attached on the rear end of the structure, leaving a significant space between the modules and front glass. Adding to this, MIRO reflectors and a special matte glass help produce a special light effect similar to that of LED panel light, only much stronger.

LUMINA LED LD luminaires are also available with special Prismatic glass which can further reduce glare. These luminaires can be installed in heights ranging up to 10 meters. LUMINA LED LN can withstand extreme temperatures and work in ambience temperatures up to + 60°C (XT version).

Good to know: The system is fit to withstand over-voltages of 4kV. On special demand, protection can be increased to 10kV.

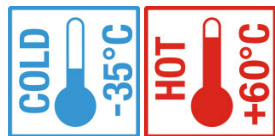

Suitable for extreme temperature conditions. Ask for XT modification.



Opal PMMA lid (optional)

Prismatic PMMA lid (optional)

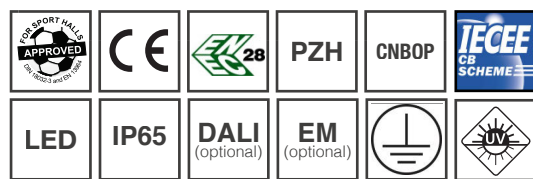
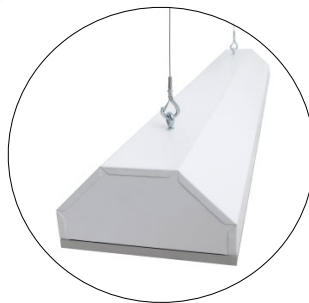

GENERAL TECHNICAL SPECIFICATIONS	
Supply Voltage	220-240V AC
Supply Frequency	50-60 Hz
RFI Suppression	EN 55015 / CISPR 15
Immunity	EN 61547
Harmonics	EN 6100-3-2
Operating Temperature*	-35 - +40 °C
Storage Temperature	-40 - +60 °C
Housing material	0.8 mm powder coated steel
Enclosure Rating	IP65
Lid material	PMMA, Polycarbonate or Tempered Glass
Cable gland	PG 13.5 or STUCCHI (3-pole) fast plug optional
Impact Resistance	IK07 or IK09

Number of LED modules	4
Lamp family code	Philips Fortimo LED
Light colour K	3000, 4000
Colour Rendering Index	> 80 or > 90
Useful life L80B50 at Ta 60 °C	100.000 h
Driver /power unit/	PHILIPS XITANIUM
Flickering	IEEE 1789
Power factor (full load at 230V)	> 0.90
Dimmable	Optional
Emergency pack	Optional
System Wattage	up to 128W
System efficacy at max luminous flux	up to 160 lm/W
System luminous flux (max)	up to 20.480 lm

* Only with Xtr drivers. Otherwise from -20 to +40 °C. Operating Temperature limitations for P/S/EM options see in next page.

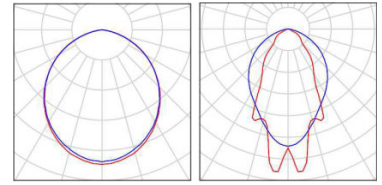

GENERAL TECHNICAL SPECIFICATIONS

EAN	Ref.	Wattage	System efficacy at max luminous flux	System luminous flux (max)	Available Options	Dimensions (mm)**				Optimum Working Height
						D	L	W	H	
4772049000179	LD-EN4/2L/4400	up to 68W	170 lm/W	11.560 lm	S/P/EM/SP/IN/1F/3F	890	1210	245	135	up to 4 m
4772049000162	LD-EN4/2L/8000	up to 128W	160 lm/W	20.480 lm						up to 6 m
4772049004627	LD-EN4/2L/12000*	up to 210W	157 lm/W	32.970 lm						up to 8 m

* not incl. in certificates yet (only CE). ** without sensor.

EAN	Additional options	Ref.
Multiple selection	PIR Sensor (-10/-30 - +35 °C)	S
Multiple selection	PIR and Light Sensor (-10/-30 - +35 °C)	P
4772049001008	Emergency Pack 3h (1h optional)	EM
4772049000940	Enforced version (-35 - +60 °C)	XT
4772049001596	Protective Sport Cage	SP
4772049001022	INOX body upgrade	IN
4772049003927	1 phase wiring cables for through-wiring	1F
4772049003934	3 phase wiring cables for through-wiring	3F

* Emergency Pack is not available in XT modification.

** There is a possibility to order ready-to-use luminaires with desired length of cable installed.

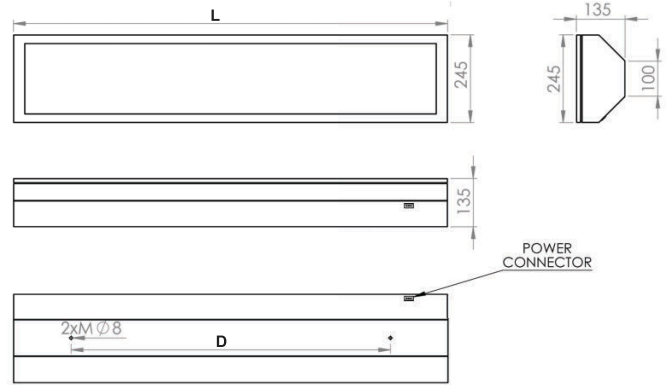

EMERGENCY PACKS

TrustSight PRO 45-300V NiMH	3 hour
Operating Temperature	0 - +40 °C



ISO 9001 - ISO 14001
OHSAS 18001

BUREAU VERITAS
Certification



ELEKTROS TAUPYMO SPRENDIMAI, UAB
Moletu str. 13, Didzioji Riese (PC "Link Moletu"), Vilnius distr. 14028, Lithuania
Liepu str. 15, Linksmakainis, Kaunas distr. 53290, Lithuania
E: info@ecolight.lt T: +370 5 2328207 F: +370 5 2784262
W: www.ecolight.lt, www.ecolight-lights.co.uk

THE ENERGY-EFFICIENT HIGH BAY LED LUMINAIRE

Models: LN-EN4/3L/4400, LN-EN4/3L/8000, LN-EN4/3L/12000



AFFORDABLE EFFICIENCY

An economical option in the LUMINA series, this LED luminaire is widely appreciated among cost-savvy industrialists. Powered by Philips Xitanium Outdoor drivers, LUMINA LED LN is an ultra-efficient luminaire which offers immediate savings of around 70% compared to traditional lightings. LUMINA LED LN luminaires can be installed in heights ranging from 4 meters to up to 20 meters. The system features easy double-point mounting.

Good to know: LUMINA LED LN can withstand extreme temperatures and can be used in temperatures up to + 60°C (XT version).

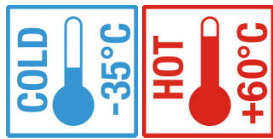
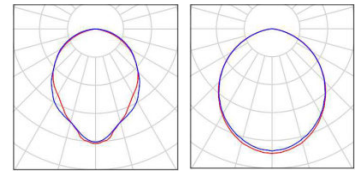

Suitable for extreme temperature conditions. Ask for XT modification.

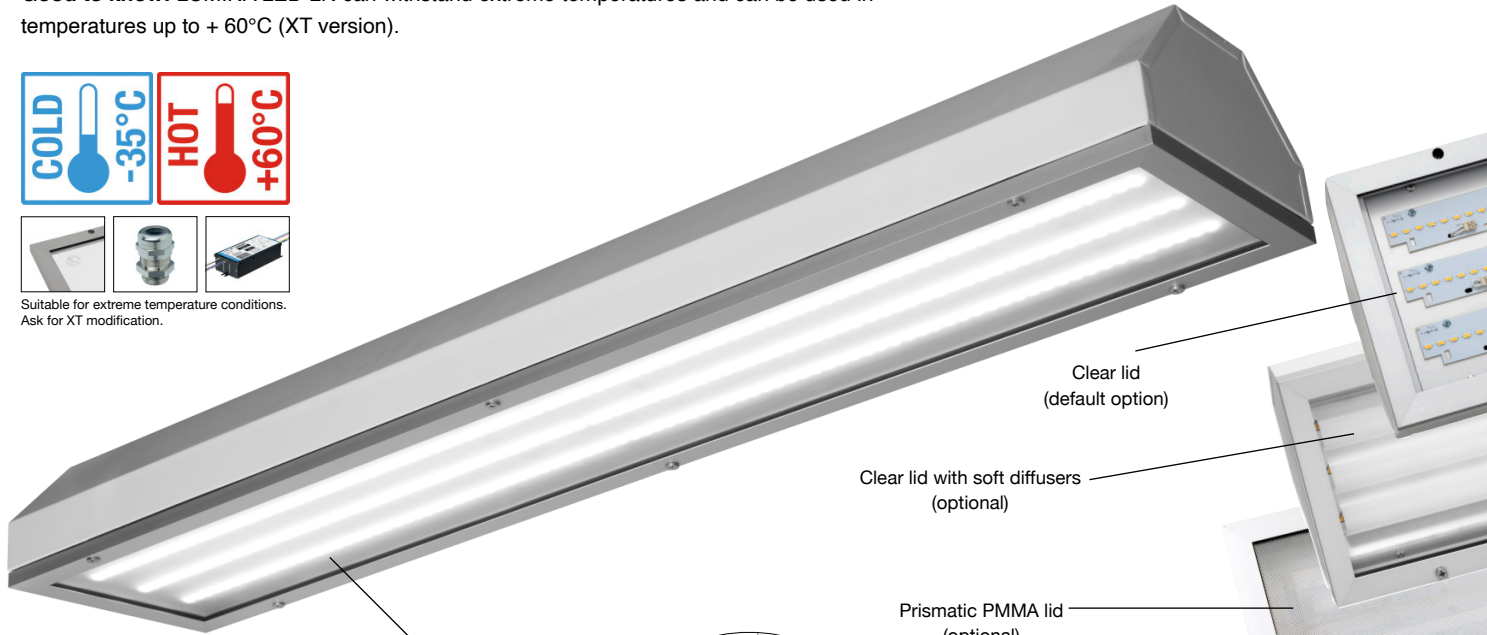

Clear lid (default option)

Clear lid with soft diffusers (optional)

Prismatic PMMA lid (optional)

Frosted tempered glass lid (optional)



GENERAL TECHNICAL SPECIFICATIONS			
Supply Voltage	220-240V AC	Number of LED modules	6
Supply Frequency	50-60 Hz	Lamp family code	Philips Fortimo LED
RFI Suppression	EN 55015 / CISPR 15	Light colour K	3000, 4000, 5000
Immunity	EN 61547	Colour Rendering Index	> 80 or > 90
Harmonics	EN 6100-3-2	Useful life L80B50 at Ta 60 °C	100.000 h
Operating Temperature*	-35 - +40 °C	Driver /power unit/	PHILIPS XITANIUM
Storage Temperature	-40 - +60 °C	Flickering	IEEE 1789
Housing material	0.8 mm powder coated steel	Power factor (full load at 230V)	> 0.90
Enclosure Rating	IP65	Dimmable	Optional
Lid material	PMMA, Polycarbonate or Tempered Glass	Emergency pack	Optional
Cable gland	PG 13.5 or STUCCHI (3-pole) fast plug optional	System Wattage	up to 200W
Impact Resistance	IK07 or IK09	System efficacy at max luminous flux	up to 160 lm/W
		System luminous flux (max)	up to 32.000 lm

* Only with Xtr drivers. Otherwise from -20 to +40 °C. Operating Temperature limitations for P/S/EM options see in next page.

GENERAL TECHNICAL SPECIFICATIONS

EAN	Ref.	Wattage	System efficacy at max luminous flux	System luminous flux (max)	Available Options	Dimensions (mm)**				Optimum Working Height
						D	L	W	H	
4772049000216	LN-EN4/3L/4400	up to 100W	176 lm/W	17.600 lm	D/S/P/EM/SP/1F/3F/IN	890	1210	245	135	up to 10 m
4772049000223	LN-EN4/3L/8000	up to 130W	171 lm/W	22.230 lm						up to 15 m
4772049000230	LN-EN4/3L/8000	up to 200W	160 lm/W	32.000 lm						up to 20 m
4772049004665	LN-EN4/3L/12000*	up to 300W	160 lm/W	48.000 lm	D/S/P/SP/1F/3F/IN					up to 20 m

* not incl. in certificates yet (only CE). ** without sensor.

EAN	Additional options	Ref.
Multiple selection	PIR Sensor (-10/-30 - +35 °C)	S
Multiple selection	PIR and Light Sensor (-10/-30 - +35 °C)	P
4772049001008	Emergency Pack 3h (1h optional)*	EM
4772049000964	Enforced version (-35 - +60 °C)	XT
4052899130357	Diffusers	D
4772049001619	Protective Sport Cage	SP
4772049001060	INOX body upgrade	IN
4772049003927	1 phase wiring cables for through-wiring	1F
4772049003934	3 phase wiring cables for through-wiring	3F

* Emergency Pack is not available in XT modification.

** There is a possibility to order ready-to-use luminaries with desired length of cable installed.

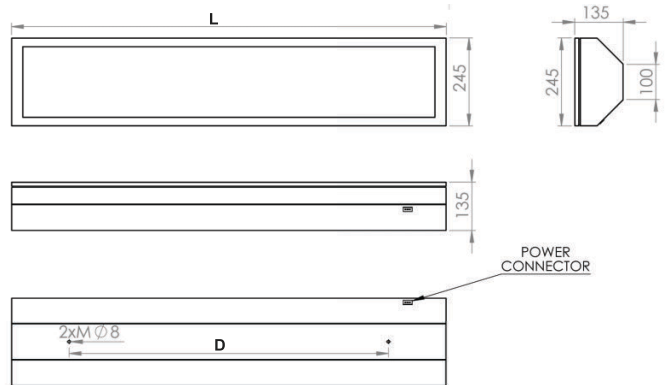

EMERGENCY PACKS

TrustSight PRO 45-300V NIMH	3 hour
Operating Temperature	0 - +40 °C



LED Luminaires
and Retrofit Bulbs
Licensing Program

Member
ECOLIGHT.
Save simple



ISO 9001 - ISO 14001
OHSAS 18001

BUREAU VERITAS
Certification



Ecolight[™]
Save simple.

ELEKTROS TAUPYMO SPRENDIMAI, UAB

Moletu str. 13, Didzioji Riese (PC "Link Moletu"), Vilnius distr. 14028, Lithuania

Liepu str. 15, Linksmakainis, Kaunas distr. 53290, Lithuania

E: info@ecolight.lt T: +370 5 2328207 F: +370 5 2784262

W: www.ecolight.lt, www.ecolight-lights.co.uk

THE ENERGY-EFFICIENT HIGH BAY LED LUMINAIRE

Models: LN-EN5/1L/5500, LN-EN5/1L/10000, LN-EN5/1L/15000,
LN-EN4/1L/4400, LN-EN4/1L/8000, LN-EN4/1L/12000,
LN-EN4/2L/4400, LN-EN4/2L/8000, LN-EN4/2L/12000,
LN-EN4/3L/4400, LN-EN4/3L/8000, LN-EN4/3L/12000,
LN-EN4/4L/4400, LN-EN4/4L/8000, LN-EN4/4L/12000,
LN-EN4/5L/8000

SAULA LED LN

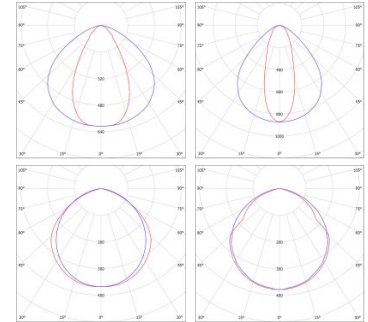

MULTIFUNCTIONAL BESTSELLER

Our flagman product, the SAULA LED LN luminaire is widely appreciated for its outstanding features and a rich variety of modification options. SAULA LED LN has few options for optics, can be covered with either clear, matte (or matte soft diffusers) or anti-glare prismatic diffuser. This LED luminaire is the go-to option for industries dealing with extreme temperatures. Due to unique technical parameters, SAULA LED LN can be used in temperatures up to + 70°C (XT version). The system is fit to withstand over-voltages of 4kV. On special demand, protection can be increased to 10kV.

Good to know: SAULA LED LN has a variety of mounting options.

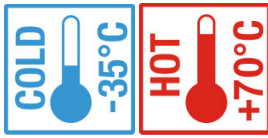

Suitable for extreme temperature conditions. Ask for XT modification.

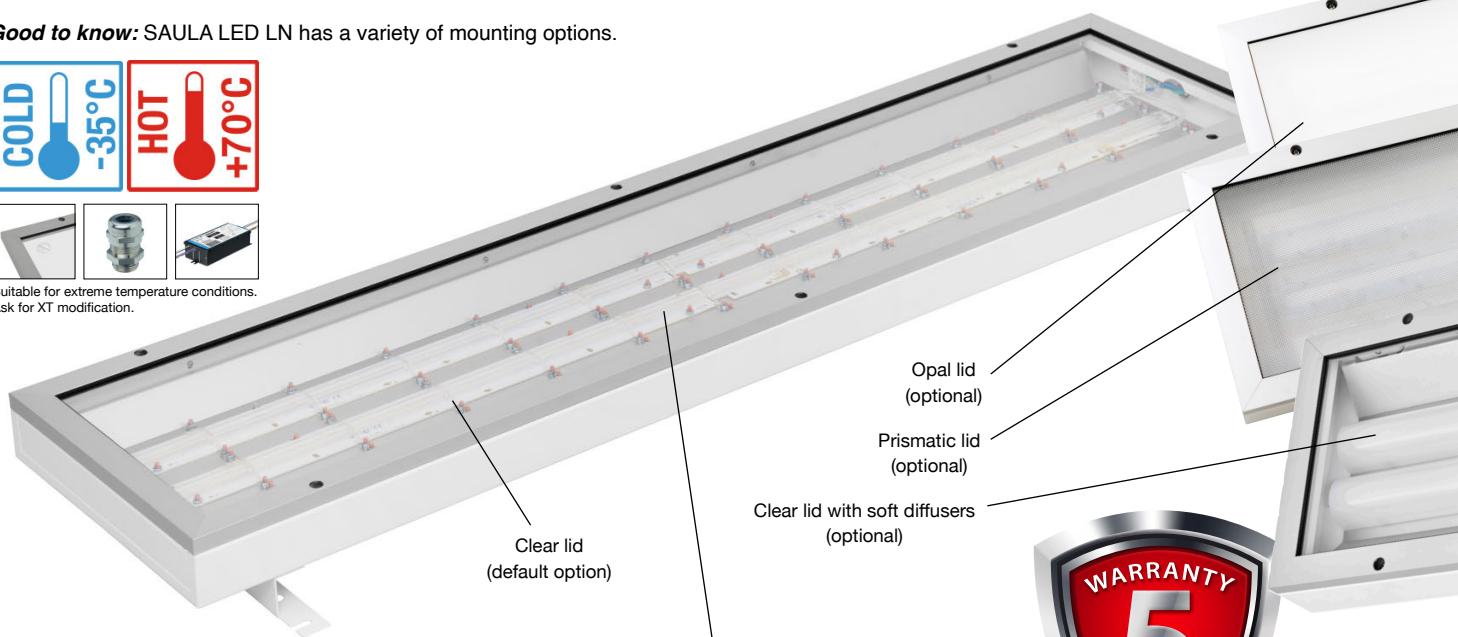

Opal lid (optional)

Prismatic lid (optional)

Clear lid with soft diffusers (optional)

Clear lid (default option)

Optics (optional)



GENERAL TECHNICAL SPECIFICATIONS

Supply Voltage	220-240V AC	Number of LED modules	up to 10
Supply Frequency	50-60 Hz	Lamp family code	PHILIPS Fortimo LED
RFI Suppression	EN 55015 / CISPR 15	Light colour K	3000, 4000 or 5000
Immunity	EN 61547	Colour Rendering Index	> 80 or >90
Harmonics	EN 6100-3-2	Useful life L80B50 at Ta 70 °C	100.000 h
Operating Temperature*	-35 - +50 °C	Driver /power unit/	PHILIPS XITANIUM (TRIDONIC**)
Storage Temperature	-40 - +60 °C	Flickering	IEEE 1789
Housing material	0.8 mm powder coated steel	Power factor (full load at 230V)	> 0.90
Enclosure Rating	IP65	Dimmable	Optional
Lid material	PMMA, Polycarbonate or Tempered Glass	Emergency pack	Optional
Cable gland	PG 13.5 or STUCCHI (3-pole) fast plug optional	System Wattage	up to 300W
Impact Resistance	IK07 or IK09	System efficacy at max luminous flux	up to 160 lm/W
		System luminous flux (max)	up to 48.000 lm

* Only with Xtr drivers. Otherwise from -20 to +50 °C. Operating Temperature limitations for P/S/EM options see in next page.

** in LN-EN4/2L/8000, LN-EN4/4L/4400, LN-EN4/4L/8000 and LN-EN4/5L/8000 models

GENERAL TECHNICAL SPECIFICATIONS

EAN	Ref.	Wattage	System efficacy at max luminous flux	System luminous flux (max)	Available Options	Dimensions (mm)**					Optimum Working Height
						L	B	H	i	b	
4772049000308	LN-EN4/1L/4400	up to 35W	170 lm/W	5.950 lm	D/S/P/EM/SP/1F/3F/IN						up to 5 m
4772049000315	LN-EN4/1L/8000	up to 65W	160 lm/W	10.400 lm	D/S/P/EM/SP/1F/3F/IN/XT	1210	175	65	950	147	up to 8 m
47720490004177	LN-EN4/1L/12000*	up to 105W	157 lm/W	16.490 lm	D/S/P/SP/1F/3F/IN						up to 10 m
4772049000322	LN-EN5/1L/5500	up to 45W	170 lm/W	7.650 lm	D/S/P/EM/SP/1F/3F/IN						up to 5 m
4772049000339	LN-EN5/1L/10000	up to 75W	160 lm/W	12.000 lm	D/S/P/EM/SP/1F/3F/IN/XT	1510	175	65	1250	147	up to 8 m
47720490004184	LN-EN5/1L/15000*	up to 128W	159 lm/W	20.350 lm	D/S/P/SP/1F/3F/IN						up to 10 m
4772049000292	LN-EN4/2L/4400	up to 68W	170 lm/W	11.560 lm	D/S/P/EM/SP/1F/3F/IN						up to 8 m
4772049000247	LN-EN4/2L/8000	up to 128W	160 lm/W	20.480 lm	D/S/P/EM/SP/1F/3F/IN/XT	1210	245	65	950	192	up to 10 m
47720490004191	LN-EN4/2L/12000*	up to 210W	157 lm/W	32.970 lm	D/S/P/SP/1F/3F/IN						up to 32 m
4772049001954	LN-EN4/3L/4400	up to 100W	176 lm/W	17.600 lm	D/S/P/EM/SP/1F/3F/IN						up to 10 m
4772049000285	LN-EN4/3L/8000	up to 200W	160 lm/W	32.000 lm	D/S/P/EM/SP/1F/3F/IN/XT	1210	285	65	950	235	up to 12 m
47720490004207	LN-EN4/3L/12000*	up to 300W	160 lm/W	48.000 lm	D/S/P/SP/1F/3F/IN						up to 20 m
4772049000254	LN-EN4/4L/4400	up to 134W	176 lm/W	23.580 lm	D/S/P/EM/SP/1F/3F/IN						up to 10 m
4772049000261	LN-EN4/4L/8000	up to 255W	160 lm/W	38.400 lm	D/S/P/EM/SP/1F/3F/IN/XT	1210	450	65	950	396	up to 15 m
47720490004214	LN-EN4/4L/12000*	up to 350W	164 lm/W	57.400 lm	D/S/P/SP/1F/3F/IN						up to 25 m
4772049000278	LN-EN4/5L/8000	up to 300W	160 lm/W	48.000 lm	D/S/P/EM/SP/1F/3F/IN/XT					400	up to 20 m

* not incl. in certificates yet (only CE). ** without sensor.

EAN	Additional options	Ref.
Multiple selection	PIR Sensor (-10/-30 - +35 °C)	S
Multiple selection	PIR and Light Sensor (-10/-30 - +35 °C)	P
4772049001008	Emergency Pack 3h (1h optional)*	EM
4772049000964	Enforced version (-35 - +70 °C)	XT
4052899130357	Diffusers	D
4772049001619	Protective Sport Cage	SP
4772049001060	INOX body upgrade	IN
4772049003927	1 phase wiring cables for through-wiring	1F
4772049003934	3 phase wiring cables for through-wiring	3F

* Emergency Pack is not available in XT modification.

** There is a possibility to order ready-to-use luminaries with desired length of cable installed.

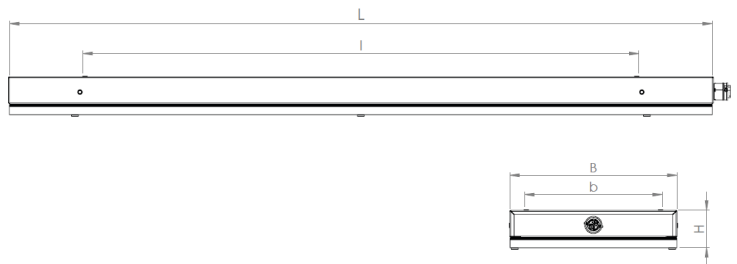

EMERGENCY PACKS

TrustSight PRO 45-300V NiMH	3 hour
Operating Temperature	0 - +40 °C



ISO 9001 - ISO 14001
OHSAS 18001

BUREAU VERITAS
Certification



ELEKTROS TAUPYMO SPRENDIMAI, UAB
Moletu str. 13, Didzioji Riese (PC "Link Moletu"), Vilnius distr. 14028, Lithuania
Liepu str. 15, Linksmakalnis, Kaunas distr. 53290, Lithuania
E: info@ecolight.lt T: +370 5 2328207 F: +370 5 2784262
W: www.ecolight.lt, www.ecolight-lights.co.uk

CHAIN OR WIRE SUSPENSION

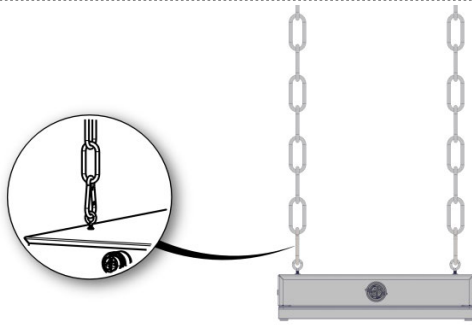

EAN	Ref.	Description
4772049000926	YF12EC500	Y-FIT CLASSIC SNAP-ON HOOK NO.1 (0-10 KG) 2M - LEG LENGTH 500MM
4772049000919	YF12EC300	Y-FIT CLASSIC SNAP-ON HOOK NO.1 (0-10 KG) 2M - LEG LENGTH 300MM
4772049000896	YF12ECS300	Y-FIT CLASSIC MINI SNAP-ON HOOK NO.1 (0-10 KG) 2M - LEG LENGTH 300MM
4772049000902	YF12ECS500	Y-FIT CLASSIC MINI SNAP-ON HOOK NO.1 (0-10 KG) 2M - LEG LENGTH 500MM
4043952670712	99008405	Eye bolts M5
4043952715062	99008407	Carabiner hook M6

STRAIGHT TO CEILING MOUNTING

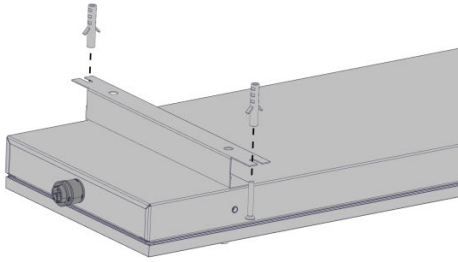

EAN	Description
4772049000865	Straight to ceiling mounting bracket for 1L SAULA LN series
4772049004245	Straight to ceiling mounting bracket for 2L SAULA LN series
4772049000872	Straight to ceiling mounting bracket for 3L SAULA LN series
4772049000889	Straight to ceiling mounting bracket for 4/5L SAULA LN series
4772049003941	Straight to ceiling mounting bracket for 1L SAULA LN series (INOX)
4772049004252	Straight to ceiling mounting bracket for 2L SAULA LN series (INOX)
4772049003958	Straight to ceiling mounting bracket for 3L SAULA LN series (INOX)
4772049003965	Straight to ceiling mounting bracket for 4/5L SAULA series (INOX)

SIDE MOUNTING

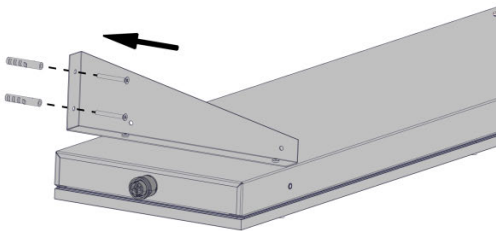

EAN	Description
4772049003972	Side mounting bracket for 1L SAULA LN series
4772049004269	Side mounting bracket for 2L SAULA LN series
4772049003989	Side mounting bracket for 3L SAULA LN series
4772049003996	Side mounting bracket for 4/5L SAULA LN series
4772049004009	Side mounting bracket for 1L SAULA LN series (INOX)
4772049004276	Side mounting bracket for 2L SAULA LN series (INOX)
4772049004016	Side mounting bracket for 3L SAULA LN series (INOX)
4772049004023	Side mounting bracket for 4/5L SAULA LN series (INOX)

ADJUSTABLE SIDE MOUNTING

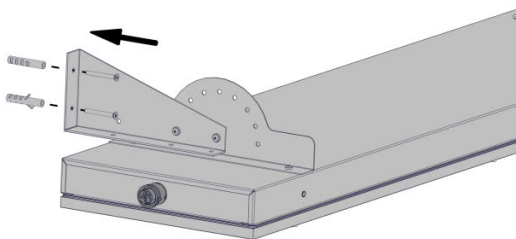

EAN	Description
4772049004030	Adjustable side mounting bracket for 1L SAULA LN series
4772049004283	Adjustable side mounting bracket for 2L SAULA LN series
4772049004047	Adjustable side mounting bracket for 3L SAULA LN series
4772049004054	Adjustable side mounting bracket for 4/5L SAULA LN series
4772049004061	Adjustable side mounting bracket for 1L SAULA LN series (INOX)
4772049004290	Adjustable side mounting bracket for 2L SAULA LN series (INOX)
4772049004078	Adjustable side mounting bracket for 3L SAULA LN series (INOX)
4772049004085	Adjustable side mounting bracket for 4/5L SAULA LN series (INOX)

PIPE HOLDER

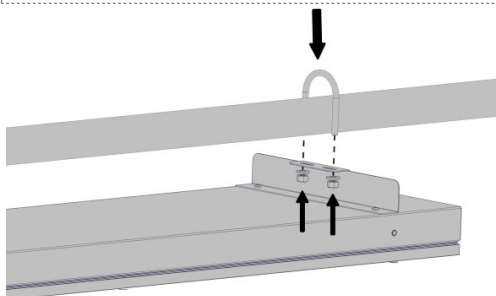

EAN	Description
4772049004092	Pipe holder bracket for 1L SAULA LN series
4772049004306	Pipe holder bracket for 2L SAULA LN series
4772049004108	Pipe holder bracket for 3L SAULA LN series
4772049004115	Pipe holder bracket for 4/5L SAULA LN series
4772049004122	Pipe holder bracket for 1L SAULA LN series (INOX)
4772049004313	Pipe holder bracket for 2L SAULA LN series (INOX)
4772049004139	Pipe holder bracket for 3L SAULA LN series (INOX)
4772049004146	Pipe holder bracket for 4/5L SAULA LN series (INOX)



Ecolight™
Save simple.

ELEKTROS TAUPYMO SPRENDIMAI, UAB
Moletu str. 13, Didzioji Riese (PC "Link Moletu"), Vilnius distr. 14028, Lithuania
Liepu str. 15, Linksmakalnis, Kaunas distr. 53290, Lithuania
E: info@ecolight.lt T: +370 5 2328207 F: +370 5 2784262
W: www.ecolight.lt, www.ecolight-lights.co.uk

THE ENERGY-EFFICIENT HIGH BAY LED LUMINAIRE

Models: LN-EN5/1L/5500, LN-EN5/1L/10000, LN-EN4/1L/4400, LN-EN4/1L/8000, LN-EN4/2L/4400, LN-EN4/2L/8000, LN-EN4/3L/4400, LN-EN4/3L/8000, LN-EN4/4L/4400, LN-EN4/4L/8000, LN-EN4/5L/8000

MULTIFUNCTIONAL BESTSELLER FOR EXPLOSION HAZARD ENVIRONMENT GROUP II, CATEGORY 2 (ZONE 2, 21 AND 22)

The metal light fitting with tempered safety glass or polycarbonate cover is suitable for environment with hazard of explosion of gases, vapours and dust for zones 2, 21 and 22. It meets the requirements of the European Community Directive No. 2014/34/EU. It fits for industrial premises like factories, power plants, army facilities, automotive factories, laboratories and other facilities of heavy and mechanical engineering. The light fitting in IP65 protection is resistant against dust and water. The system is fit to withstand over-voltages of 4kV.

Good to know: SAULA LED LN has a variety of mounting options.

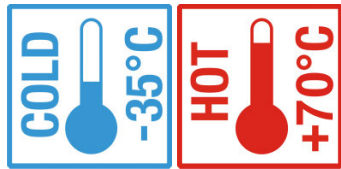

GENERAL TECHNICAL SPECIFICATIONS	
Supply Voltage	220-240V AC
Supply Frequency	50-60 Hz
RFI Suppression	EN 55015 / CISPR 15
Immunity	EN 61547
Harmonics	EN 6100-3-2
Operating Temperature	-20 - +50 °C (-20 - +70 °C for XT version)
Storage Temperature	-40 - +60 °C
Housing material	0.8 mm powder coated steel
Enclosure Rating	IP65
Lid material	Tempered Glass or Polycarbonate
Cable gland	
Impact Resistance	IK07 or IK09

* in LN-EN4/2L/8000, LN-EN4/4L/8000 and LN-EN4/5L/8000 models

SAULA LED LN Ex

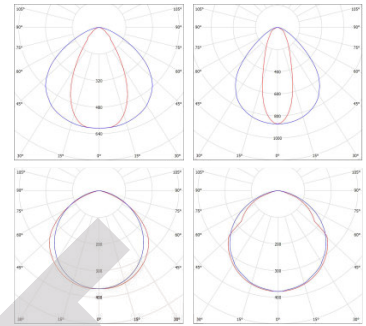

Clear lid with optics (optional)

Clear lid with soft diffusers (optional)

Clear lid (default option)



The basic requirements for safety and health protection are secured by verification of conformity with PN-EN IEC 60079-0:2018-09 (EN IEC 60079-0:2018), PN-EN 60079-7:2016-02 (EN 60079-7:2015), PN-EN 60079-31:2014-10 (EN 60079-31:2014), PN-EN 60079-28:2015-12 (EN 60079-28:2015).

Number of LED modules	up to 10
Lamp family code	PHILIPS Fortimo LED
Light colour K	3000, 4000 or 5000
Colour Rendering Index	> 80
Useful life L80B50 at Ta 70 °C	100.000 h
Driver /power unit/	PHILIPS XITANIUM (TRIDONIC*)
Flickering	IEEE 1789
Power factor (full load at 230V)	> 0.90
Dimmable	Optional (DALI)
Emergency pack	Optional
System Wattage	up to 300W
System efficacy at max luminous flux	up to 160 lm/W
System luminous flux (max)	up to 48.000 lm

GENERAL TECHNICAL SPECIFICATIONS

EAN	Ref.	Wattage	System efficacy at max luminous flux	System luminous flux (max)	Available Options	Temperature Class	Dimensions (mm)					Optimum Working Height
							L	B	H	i	b	
	LN-EN4/1L/4400	up to 35W	170 lm/W	5.950 lm	D/EM/SP/1F/3F	T6						up to 5 m
	LN-EN4/1L/8000	up to 65W	160 lm/W	10.400 lm	D/EM/SP/1F/3F	T6	1210	175	65	950	147	up to 8 m
	LN-EN4/1L/8000/XT	up to 65W	160 lm/W	10.400 lm	D/SP/1F/3F	T4						up to 8 m
	LN-EN5/1L/5500	up to 45W	170 lm/W	7.650 lm	D/EM/SP/1F/3F	T6						up to 5 m
	LN-EN5/1L/10000	up to 75W	160 lm/W	12.000 lm	D/EM/SP/1F/3F	T6	1510	175	65	1250	147	up to 8 m
	LN-EN5/1L/10000/XT	up to 75W	160 lm/W	12.000 lm	D/SP/1F/3F	T4						up to 8 m
	LN-EN4/2L/4400	up to 68W	170 lm/W	11.560 lm	D/EM/SP/1F/3F	T6						up to 8 m
	LN-EN4/2L/8000	up to 128W	160 lm/W	20.480 lm	D/EM/SP/1F/3F	T6	1210	245	65	950	192	up to 10 m
	LN-EN4/2L/8000/XT	up to 128W	160 lm/W	20.480 lm	D/SP/1F/3F	T4						up to 10 m
	LN-EN4/3L/4400	up to 100W	176 lm/W	17.600 lm	D/EM/SP/1F/3F	T6						up to 10 m
	LN-EN4/3L/8000	up to 200W	160 lm/W	32.000 lm	D/EM/SP/1F/3F	T6	1210	285	65	950	235	up to 12 m
	LN-EN4/3L/8000/XT	up to 200W	160 lm/W	32.000 lm	D/SP/1F/3F	T4						up to 12 m
	LN-EN4/4L/4400	up to 134W	176 lm/W	23.580 lm	D/EM/SP/1F/3F	T6						up to 10 m
	LN-EN4/4L/8000	up to 255W	160 lm/W	38.400 lm	D/EM/SP/1F/3F	T6						up to 15 m
	LN-EN4/4L/8000/XT	up to 255W	160 lm/W	38.400 lm	D/SP/1F/3F	T4	1210	450	65	950	396	up to 15 m
	LN-EN4/5L/8000	up to 300W	160 lm/W	48.000 lm	D/EM/SP/1F/3F	T6						up to 20 m
	LN-EN4/5L/8000/XT	up to 300W	160 lm/W	48.000 lm	D/SP/1F/3F	T4						up to 20 m

EAN	Additional options	Ref.
4772049001008	Emergency Pack 3h (1h optional)*	EM
4052899130357	Diffusers	D
4772049001619	Protective Sport Cage	SP
4772049003927	1 phase wiring cables for through-wiring	1F
4772049003934	3 phase wiring cables for through-wiring	3F

* Emergency Pack is not available in XT modification.



CABLE GLANDS

Ref.	Cable glands for Zone 21	Ref.	Cable glands for Zone 2, 22
PL.BG220MSEX	Blueglobe Ex e II M20x1.5 (brass nickel plated)*	PL.BG220MSEX	Blueglobe Ex e II M20x1.5 (brass nickel plated)*
PL.22052Y8EX	UNI Ex e II M20x1.5 (plastic)*	PL.22052Y8EX	UNI Ex e II M20x1.5 (plastic)*
		X6.051.6053.1	RST20i5 5 pole female connector (250/400V, 20A, black)
		X6.052.6053.1	RST20i5 5 pole male connector (250/400V, 20A, black)
		X6.031.2053.1	RST20i3 3 pole female connector (250/400V, 20A, black)
		X6.032.2053.1	RST20i3 3 pole male connector (250/400V, 20A, black)

* mandatory to fit cable at the factory

EMERGENCY PACKS

TrustSight PRO 45-300V NiMH	3 hour
Operating Temperature	0 - +40 °C



ISO 9001 - ISO 14001
OHSAS 18001

BUREAU VERITAS
Certification



Ecolight[™]
Save simple.

ELEKTROS TAUPYMO SPRENDIMAI, UAB
Moletu str. 13, Didzioji Riese (PC "Link Moletu"), Vilnius distr. 14028, Lithuania
Liepu str. 15, Linksmakalnis, Kaunas distr. 53290, Lithuania
E: info@ecolight.lt T: +370 5 2328207 F: +370 5 2784262
W: www.ecolight.lt, www.ecolight-lights.co.uk

CHAIN OR WIRE SUSPENSION

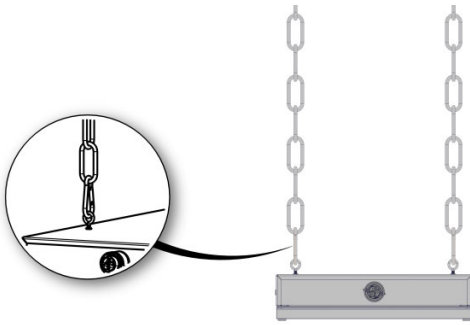

EAN	Ref.	Description
4772049000926	YF12EC500	Y-FIT CLASSIC SNAP-ON HOOK NO.1 (0-10 KG) 2M - LEG LENGTH 500MM
4772049000919	YF12EC300	Y-FIT CLASSIC SNAP-ON HOOK NO.1 (0-10 KG) 2M - LEG LENGTH 300MM
4772049000896	YF12ECS300	Y-FIT CLASSIC MINI SNAP-ON HOOK NO.1 (0-10 KG) 2M - LEG LENGTH 300MM
4772049000902	YF12ECS500	Y-FIT CLASSIC MINI SNAP-ON HOOK NO.1 (0-10 KG) 2M - LEG LENGTH 500MM
4043952670712	99008405	Eye bolts M5
4043952715062	99008407	Carabiner hook M6

STRAIGHT TO CEILING MOUNTING

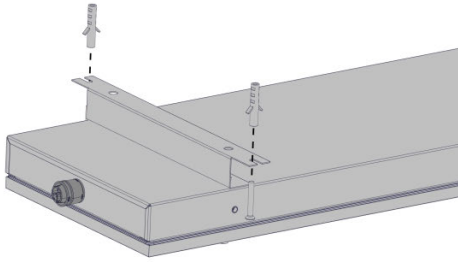

EAN	Description
4772049000865	Straight to ceiling mounting bracket for 1L SAULA LN series
4772049004245	Straight to ceiling mounting bracket for 2L SAULA LN series
4772049000872	Straight to ceiling mounting bracket for 3L SAULA LN series
4772049000889	Straight to ceiling mounting bracket for 4/5L SAULA LN series
4772049003941	Straight to ceiling mounting bracket for 1L SAULA LN series (INOX)
4772049004252	Straight to ceiling mounting bracket for 2L SAULA LN series (INOX)
4772049003958	Straight to ceiling mounting bracket for 3L SAULA LN series (INOX)
4772049003965	Straight to ceiling mounting bracket for 4/5L SAULA series (INOX)

SIDE MOUNTING

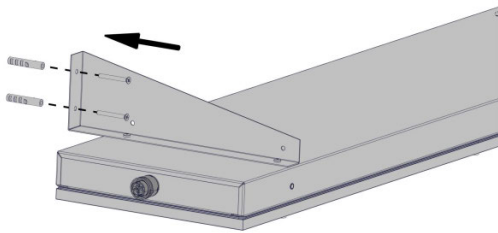

EAN	Description
4772049003972	Side mounting bracket for 1L SAULA LN series
4772049004269	Side mounting bracket for 2L SAULA LN series
4772049003989	Side mounting bracket for 3L SAULA LN series
4772049003996	Side mounting bracket for 4/5L SAULA LN series
4772049004009	Side mounting bracket for 1L SAULA LN series (INOX)
4772049004276	Side mounting bracket for 2L SAULA LN series (INOX)
4772049004016	Side mounting bracket for 3L SAULA LN series (INOX)
4772049004023	Side mounting bracket for 4/5L SAULA LN series (INOX)

ADJUSTABLE SIDE MOUNTING

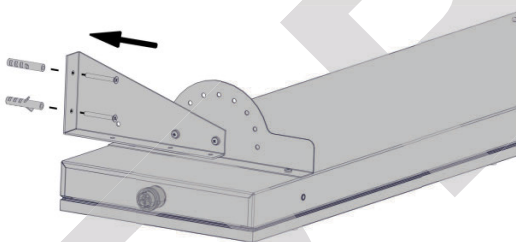

EAN	Description
4772049004030	Adjustable side mounting bracket for 1L SAULA LN series
4772049004283	Adjustable side mounting bracket for 2L SAULA LN series
4772049004047	Adjustable side mounting bracket for 3L SAULA LN series
4772049004054	Adjustable side mounting bracket for 4/5L SAULA LN series
4772049004061	Adjustable side mounting bracket for 1L SAULA LN series (INOX)
4772049004290	Adjustable side mounting bracket for 2L SAULA LN series (INOX)
4772049004078	Adjustable side mounting bracket for 3L SAULA LN series (INOX)
4772049004085	Adjustable side mounting bracket for 4/5L SAULA LN series (INOX)

PIPE HOLDER

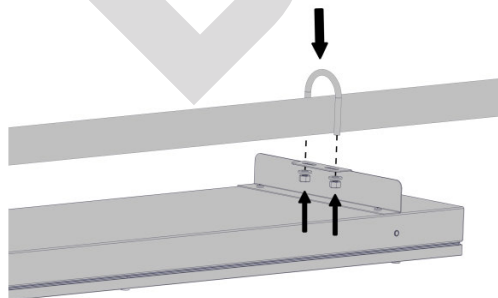

EAN	Description
4772049004092	Pipe holder bracket for 1L SAULA LN series
4772049004306	Pipe holder bracket for 2L SAULA LN series
4772049004108	Pipe holder bracket for 3L SAULA LN series
4772049004115	Pipe holder bracket for 4/5L SAULA LN series
4772049004122	Pipe holder bracket for 1L SAULA LN series (INOX)
4772049004313	Pipe holder bracket for 2L SAULA LN series (INOX)
4772049004139	Pipe holder bracket for 3L SAULA LN series (INOX)
4772049004146	Pipe holder bracket for 4/5L SAULA LN series (INOX)



Ecolight™
Save simple.

ELEKTROS TAUPYMO SPRENDIMAI, UAB

Moletu str. 13, Didzioji Riese (PC "Link Moletu"), Vilnius distr. 14028, Lithuania

Liepu str. 15, Linksmakalnis, Kaunas distr. 53290, Lithuania

E: info@ecolight.lt T: +370 5 2328207 F: +370 5 2784262

W: www.ecolight.lt, www.ecolight-lights.co.uk

SAULA INOX LED LN

THE ENERGY-EFFICIENT HIGH BAY LED LUMINAIRE

Models: LN-EN2/1L/ 2200, LN-EN2/1L/4000, LN-EN4/1L/4400,
LN-EN4/1L/8000, LN-EN4/2L/8000, LN-EN5/1L/5500,
LN-EN5/1L/10000

THE GO-TO OPTION FOR FOOD PROCESSING INDUSTRIES

SAULA LED LN INOX is designed to meet the robust requirements of food processing industries. Food processing environments require luminaires that are resistant to corrosion, and can withstand rigorous disinfection protocols. SAULA LED LN INOX is made from premium quality 316L stainless steel. It features all the functionalities and characteristics of standard SAULA LED LN luminaires.

Good to know: SAULA LED LN INOX is an IP66 rated luminaire.

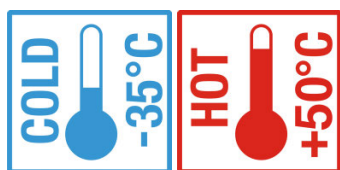
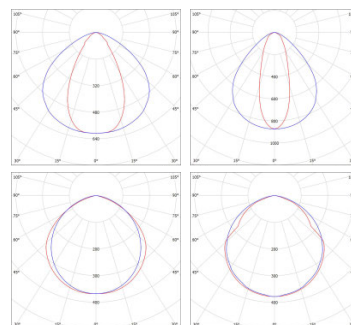

GENERAL TECHNICAL SPECIFICATIONS			
Supply Voltage	220-240V AC	Number of LED modules	up to 4
Supply Frequency	50-60 Hz	Lamp family code	PHILIPS Fortimo LED
RFI Suppression	EN 55015 / CISPR 15	Light color K	3000, 4000 or 5000
Immunity	EN 61547	Color Rendering Index	> 80 or > 90
Harmonics	EN 6100-3-2	Useful life L80B50 at Ta 50 °C	100.000 h
Operating Temperature**	-35 - +50 °C	Driver /power unit/	PHILIPS XITANIUM
Storage Temperature	-40 - +60 °C	Flickering	IEEE 1789
Housing material	Stainless steel	Power factor (full load at 230V)	> 0.90
Enclosure Rating	IP66	Dimmable	Optional
Lid material	Tempered Glass	Emergency pack	No
Cable gland	Stainless steel	System Wattage	up to 128W
Impact Resistance	IK07 or IK09	System efficacy at max luminous flux	up to 160 lm/W
		System luminous flux (max)	up to 20.480 lm

* in preparation

** Only with Xtr drivers. Otherwise from -20 to +50 °C.

GENERAL TECHNICAL SPECIFICATIONS

EAN	Ref.	Wattage	System efficacy at max luminous flux	System luminous flux (max)	Available Options	Dimensions (mm)					Optimum Working Height
						L	W	H	i	b	
4772049002081	LN-EN4/1L/4400	up to 35W	170 lm/W	5.950 lm	D/1F/3F	1210	175	60			up to 5 m
4772049002098	LN-EN4/1L/8000	up to 65W	160 lm/W	10.400 lm							
4772049002104	LN-EN5/1L/5500	up to 45W	170 lm/W	7.650 lm		1510	175	60			up to 8 m
4772049002111	LN-EN5/1L/10000	up to 75W	160 lm/W	12.000 lm							
4772049000247	LN-EN4/2L/8000	up to 128W	160 lm/W	20.480 lm							

EAN	Additional options	Ref.
4052899130357	Diffusers	D
4772049003927	1 phase wiring cables for through-wiring	1F
4772049003934	3 phase wiring cables for through-wiring	3F

* There is a possibility to order ready-to-use luminaries with desired length of cable installed.

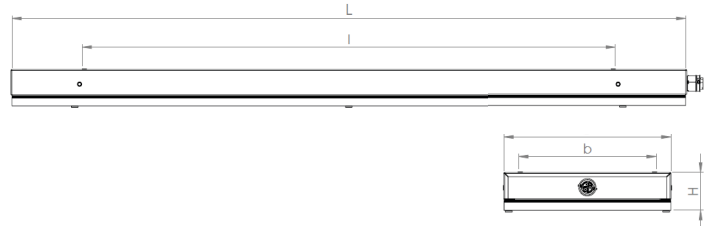



LED Luminaires and Retrofit Bulbs Licensing Program

Member
ECOLIGHT.
Save simple



**ISO 9001 - ISO 14001
OHSAS 18001**

**BUREAU VERITAS
Certification**



Ecolight™
Save simple.

ELEKTROS TAUPYMO SPRENDIMAI, UAB
 Moletu str. 13, Didzioji Riese (PC "Link Moletu"), Vilnius distr. 14028, Lithuania
 Liepu str. 15, Linksmakalnis, Kaunas distr. 53290, Lithuania
 E: info@ecolight.lt T: +370 5 2328207 F: +370 5 2784262
 W: www.ecolight.lt, www.ecolight-lights.co.uk

CHAIN OR WIRE SUSPENSION

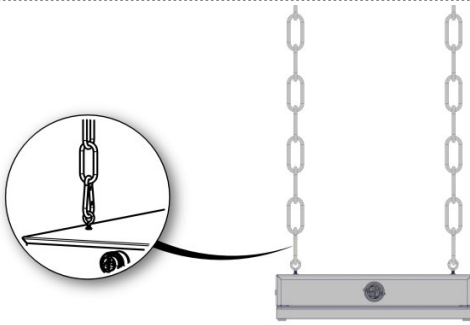

EAN	Ref.	Description
4772049000926	YF12EC500	Y-FIT CLASSIC SNAP-ON HOOK NO.1 (0-10 KG) 2M - LEG LENGTH 500MM
4772049000919	YF12EC300	Y-FIT CLASSIC SNAP-ON HOOK NO.1 (0-10 KG) 2M - LEG LENGTH 300MM
4772049000896	YF12ECS300	Y-FIT CLASSIC MINI SNAP-ON HOOK NO.1 (0-10 KG) 2M - LEG LENGTH 300MM
4772049000902	YF12ECS500	Y-FIT CLASSIC MINI SNAP-ON HOOK NO.1 (0-10 KG) 2M - LEG LENGTH 500MM
4043952670712	99008405	Eye bolts M5
4043952715062	99008407	Carabiner hook M6

STRAIGHT TO CEILING MOUNTING

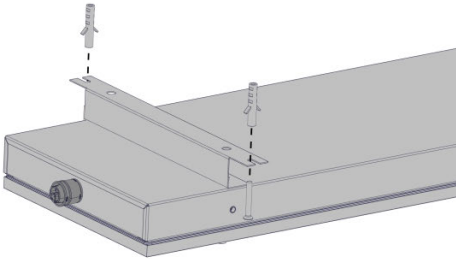

EAN	Description
4772049003941	Straight to ceiling mounting bracket for 1L SAULA LN series (INOX)
4772049004252	Straight to ceiling mounting bracket for 2L SAULA LN series (INOX)

SIDE MOUNTING

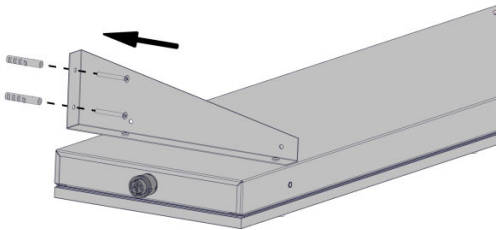

EAN	Description
4772049004009	Side mounting bracket for 1L SAULA LN series (INOX)
4772049004276	Side mounting bracket for 2L SAULA LN series (INOX)

ADJUSTABLE SIDE MOUNTING

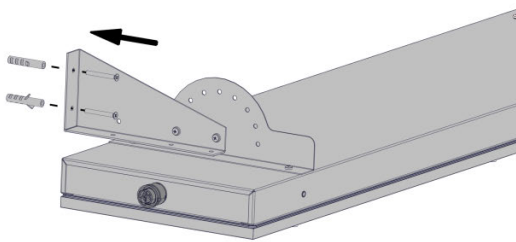

EAN	Description
4772049004061	Adjustable side mounting bracket for 1L SAULA LN series (INOX)
4772049004290	Adjustable side mounting bracket for 2L SAULA LN series (INOX)

PIPE HOLDER

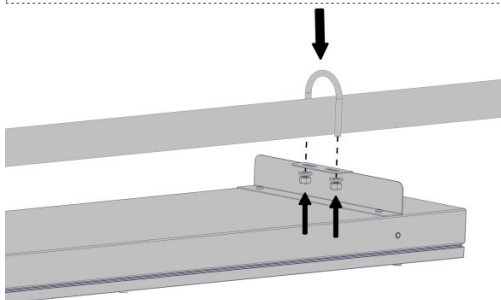

EAN	Description
4772049004122	Pipe holder bracket for 1L SAULA LN series (INOX)
4772049004313	Pipe holder bracket for 2L SAULA LN series (INOX)



Ecolight[™]
Save simple.

ELEKTROS TAUPYMO SPRENDIMAI, UAB
Moletu str. 13, Didzioji Riese (PC "Link Moletu"), Vilnius distr. 14028, Lithuania
Liepu str. 15, Linksmakalnis, Kaunas distr. 53290, Lithuania
E: info@ecolight.lt T: +370 5 2328207 F: +370 5 2784262
W: www.ecolight.lt, www.ecolight-lights.co.uk

LUMINA INOX LED LN

THE ENERGY-EFFICIENT HIGH BAY LED LUMINAIRE

Models: LN-EN4/1L/4400, LN-EN4/1L/8000,
LN-EN5/1L/5500, LN-EN5/1L/10000

THE GO-TO OPTION FOR FOOD PROCESSING INDUSTRIES

LUMINA LED LN INOX is designed to meet the robust requirements of food processing industries. Food processing environments require luminaires that are resistant to corrosion, and can withstand rigorous disinfection protocols. LUMINA LED LN INOX is made from premium quality 316L stainless steel. It features all the functionalities and characteristics of standard LUMINA LED LN luminaires.

Good to know: LUMINA LED LN INOX is an IP66 rated luminaire.

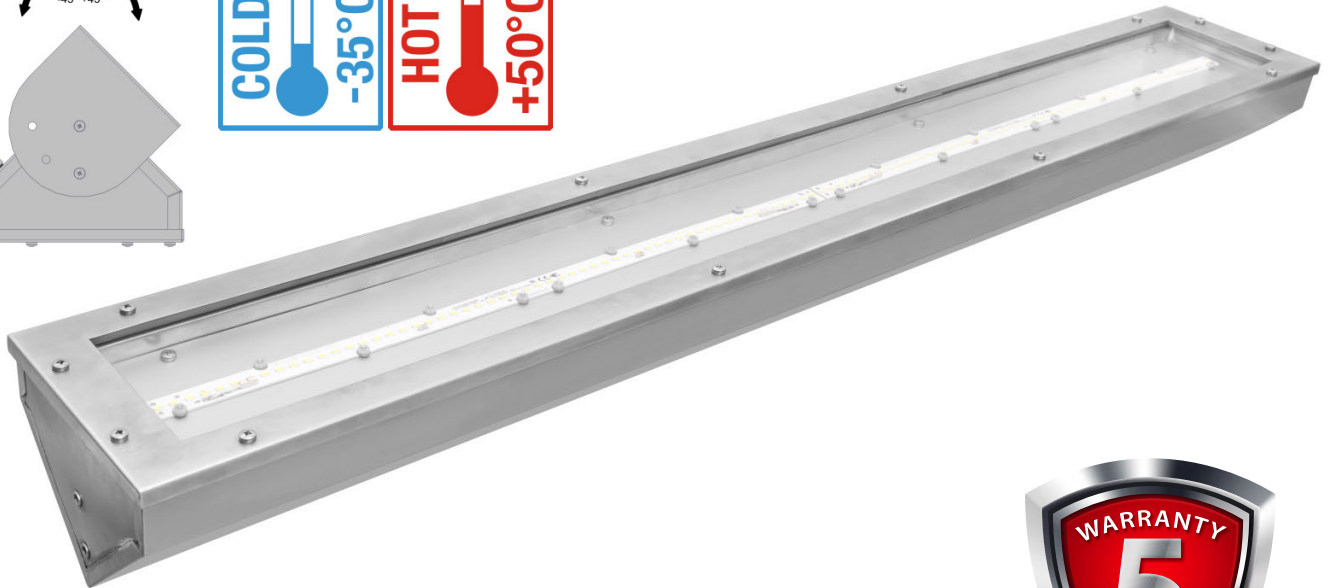
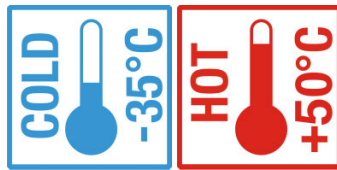
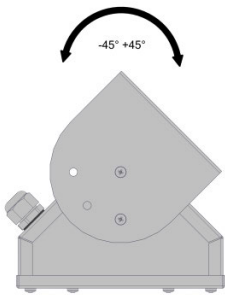
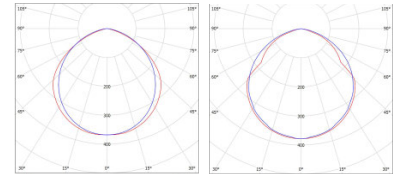

GENERAL TECHNICAL SPECIFICATIONS		Number of LED modules	up to 3
Supply Voltage	220-240V AC	Lamp family code	PHILIPS Fortimo LED
Supply Frequency	50-60 Hz	Light color K	3000, 4000 or 5000
RFI Suppression	EN 55015 / CISPR 15	Color Rendering Index	> 80 or > 90
Immunity	EN 61547	Useful life L80B50 at Ta 50 °C	100.000 h
Harmonics	EN 61000-3-2	Driver /power unit/	PHILIPS XITANIUM
Operating Temperature**	-35 - +50 °C	Flickering	IEEE 1789
Storage Temperature	-40 - +60 °C	Power factor (full load at 230V)	> 0.90
Housing material	Stainless steel	Dimmable	Optional
Enclosure Rating	IP66	Emergency pack	No
Lid material	PMMA, PC or Tempered Glass	System Wattage	up to 75W
Cable gland	Nickel plated brass	System efficacy at max luminous flux	up to 160 lm/W
Impact Resistance	IK07 or IK09	System luminous flux (max)	up to 12.000 lm

* in preparation

** Only with Xtr drivers. Otherwise from -20 to +50 °C.

GENERAL TECHNICAL SPECIFICATIONS

EAN	Ref.	Wattage	System efficacy at max luminous flux	System luminous flux (max)	Available Options	Dimensions (mm)			Optimum Working Height
						L	W	H	
4772049002081	LN-EN4/1L/4400	up to 35W	170 lm/W	5.950 lm	D/1F/3F	1210	175	60	up to 5 m
4772049002098	LN-EN4/1L/8000	up to 65W	160 lm/W	10.400 lm					
4772049002104	LN-EN5/1L/5500	up to 45W	170 lm/W	7.650 lm		1510	175	60	up to 8 m
4772049002111	LN-EN5/1L/10000	up to 75W	160 lm/W	12.000 lm					

EAN	Additional options	Ref.
4052899130357	Diffusers	D
4772049003927	1 phase wiring cables for through-wiring	1F
4772049003934	3 phase wiring cables for through-wiring	3F

* There is a possibility to order ready-to-use luminaires with desired length of cable installed.

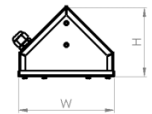
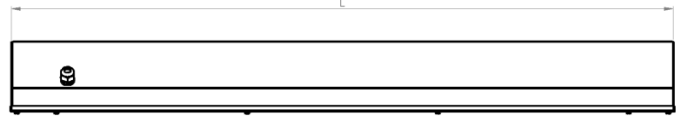

LED Luminaires and Retrofit Bulbs Licensing Program

Member
ECOLIGHT.
Save simple

**ISO 9001 - ISO 14001
OHSAS 18001**

**BUREAU VERITAS
Certification**



Ecolight™
Save simple.

ELEKTROS TAUPYMO SPRENDIMAI, UAB
 Moletu str. 13, Didzioji Riese (PC "Link Moletu"), Vilnius distr. 14028, Lithuania
 Liepu str. 15, Linksmakalnis, Kaunas distr. 53290, Lithuania
 E: info@ecolight.lt T: +370 5 2328207 F: +370 5 2784262
 W: www.ecolight.lt, www.ecolight-lights.co.uk

THE ENERGY-EFFICIENT HIGH BAY LED LUMINAIRE

Models: RM-EN1/1L/26000

A SMART WAY TO UPGRADE EFFICIENCY

If you are looking to upgrade on your old lighting systems quipped with HIE/ HIT or HSE/HST lamps (250W or 400W), this is your answer. RAMUNE LED RM is simply a great LED lighting solution that works as a 1:1 replacement for your old, less efficient systems. For cost-savvy companies with standard industry needs, RAMUNE LED RM is the smartest way to eliminate waste and upgrade efficiency.

Good to know: RAMUNE LED RM IP65 features easy single-point mounting.

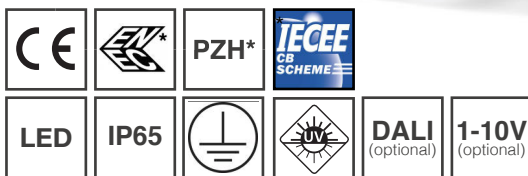
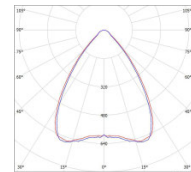
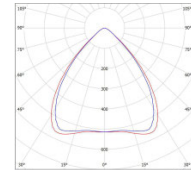
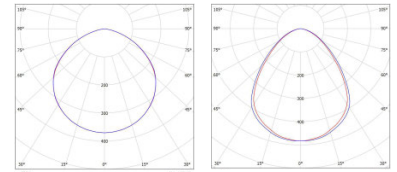

GENERAL TECHNICAL SPECIFICATIONS

Supply Voltage	220-240V AC	Number of LED modules	1
Supply Frequency	50-60 Hz	Lamp family code	LUMILEDS
RFI Suppression	EN 55015 / CISPR 15	Light colour K	4000, 5000 or 6500
Immunity	EN 61547	Colour Rendering Index	> 80
Harmonics	EN 6100-3-2	Useful life L70B50 at Ta 45 °C	50.000 h
Operating Temperature	-25 - +45 °C	Driver /power unit/	TRIDONIC or MEANWELL
Storage Temperature	-40 - +60 °C	Flickering	IEEE 1789
Housing material	Cast Aluminum	Power factor (full load at 230V)	> 0.90
Enclosure Rating	IP65	Dimmable	Optional
Lid material	Tempered Glass	System Wattage	up to 197W
Cable gland	Stainless steel	System efficacy at max luminous flux	up to 117 lm/W
Protection class IEC	Safety class I	System luminous flux (max)	up to 23.050 lm

* in preparation

GENERAL TECHNICAL SPECIFICATIONS

EAN	Ref.	Wattage	System efficacy at max luminous flux	System luminous flux (max)	Dimensions (mm)			Optimum Working Height
					D	H1	H2	
4772049001916	RM-EN1/1L/26000	65W	141 lm/W	9.165 lm	390	165	180	up to 8 m
4772049002067	RM-EN1/1L/26000	93W	137 lm/W	12.740 lm				up to 10 m
4772049002074	RM-EN1/1L/26000	144W	125 lm/W	18.000 lm				up to 12 m
4772049001923	RM-EN1/1L/26000	197W	117 lm/W	23.050 lm				up to 15 m

EAN	Additional options	Ref.
4772049002623	Metal 60 deg. beam reflector	SL-ACC-HB-REF-60D
4772049002630	Transparent PMMA 60 deg. beam reflector	SL-ACC-HB-REF-60D-TP
4772049002647	Plug-in 90 deg. beam optics	SL-ACC-HB-PRI-90D
4772049002654	Wall mounting bracket	SL-ACC-HB-WALL-M
4772049002661	IP68 connector	SL-ACC-HB-IP68Con
4772049001008	Emergency Pack 3h (1h optional)	EM
4772049003927	1 phase wiring cables for through-wiring	1F
4772049003934	3 phase wiring cables for through-wiring	3F

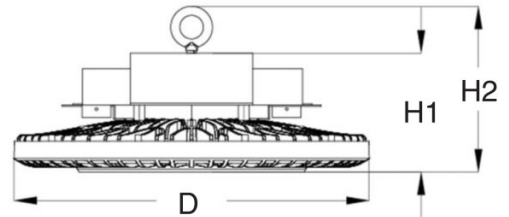

* There is a possibility to order ready-to-use luminaires with desired length of cable installed.

ACCESSORIES

EAN	Description	Picture
4772049004221	UNIVERSAL MOUNTING BRACKET FOR RAMUNE	

EMERGENCY PACKS

Tridonic EM converterLED BASIC 200 V	3 hour
Operating Temperature	0 - +40 °C

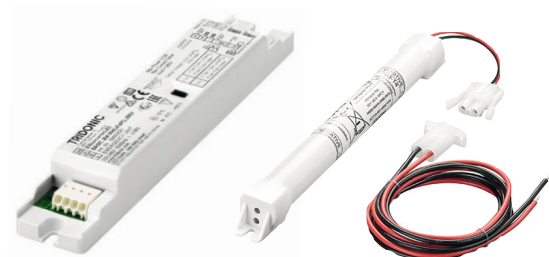

ISO 9001 - ISO 14001
OHSAS 18001

BUREAU VERITAS
Certification



ELEKTROS TAUPYMO SPRENDIMAI, UAB
Moletu str. 13, Didzioji Riese (PC "Link Moletu"), Vilnius distr. 14028, Lithuania
Liepu str. 15, Linksmakalnis, Kaunas distr. 53290, Lithuania
E: info@ecolight.lt T: +370 5 2328207 F: +370 5 2784262
W: www.ecolight.lt, www.ecolight-lights.co.uk

THE ENERGY-EFFICIENT HIGH BAY LED LUMINAIRE

Models: SW-EN1/4L/1100, SW-EN1/4L/2000,
SW-EN1/4L/3000

SAULA LED SW

WHEN SIZE AND SHAPE MATTER

These unique models were created for niche industry needs. Uniquely shaped and sized, SAULA LED SW is an ultra-efficient lighting system. Gains in efficiency are obtained through the use of state-of-the-art MIRO reflectors.

Good to know: LED modules are positioned deep in the system to prevent glare.

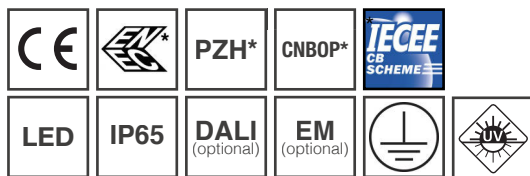
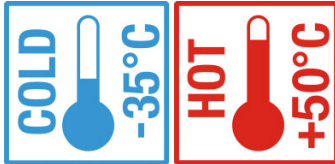
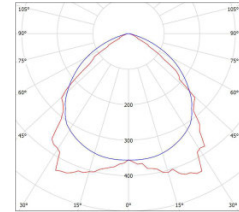

GENERAL TECHNICAL SPECIFICATIONS		Number of LED modules	4
Supply Voltage	220-240V AC	Lamp family code	PHILIPS Fortimo
Supply Frequency	50-60 Hz	Light colour K	3000, 4000, 5000
RFI Suppression	EN 55015 / CISPR 15	Colour Rendering Index	> 80 or > 90
Immunity	EN 61547	Useful life L80B50 at Ta 50 °C	100.000 h
Harmonics	EN 6100-3-2	Driver /power unit/	PHILIPS XITANIUM
Operating Temperature**	-35 - +50 °C	Flickering	IEEE 1789
Storage Temperature	-40 - +60 °C	Power factor (full load at 230V)	> 0.90
Housing material	0.8 mm powder coated steel	Dimmable	Optional
Enclosure Rating	IP65	Emergency pack	Optional
Lid material	PMMA or Polycarbonate	System Wattage	up to 105W
Cable gland	PG 13.5 or STUCCHI (3-pole) fast plug optional	System efficacy at max luminous flux	up to 157 lm/W
Impact Resistance	IK07 or IK09	System luminous flux (max)	up to 16.490 lm

* in preparation

** Only with Xtr drivers. Otherwise from -20 to +50 °C. Operating Temperature limitations for EM options see in next page.

GENERAL TECHNICAL SPECIFICATIONS

EAN	Ref.	Wattage	System efficacy at max luminous flux	System luminous flux (max)	Available Options	Dimensions (mm)			Optimum Working Height
						L	W	H	
4772049000346	SW-EN1/4L/1100	up to 36W	170 lm/W	6.120 lm	S/P/EM/SP/IN/1F/3F	440	430	75	up to 3 m
4772049000353	SW-EN1/4L/2000	up to 68W	157 lm/W	10.675 lm					up to 4 m
4772049004238	SW-EN1/4L/3000	up to 105W	157 lm/W	16.490 lm	S/P/SP/IN/1F/3F				up to 6 m

EAN	Additional options	Ref.
Multiple selection	PIR Sensor (-10/-30 - +35 °C)	S
Multiple selection	PIR and Light Sensor (-10/-30 - +35 °C)	P
4772049001008	Emergency Pack 3h (1h optional)*	EM
4772049001619	Protective Sport Cage	SP
4772049001060	INOX body upgrade	IN
4772049003927	1 phase wiring cables for through-wiring	1F
4772049003934	3 phase wiring cables for through-wiring	3F

* Emergency Pack is not available for powers above 68W.

** There is a possibility to order ready-to-use luminaires with desired length of cable installed.

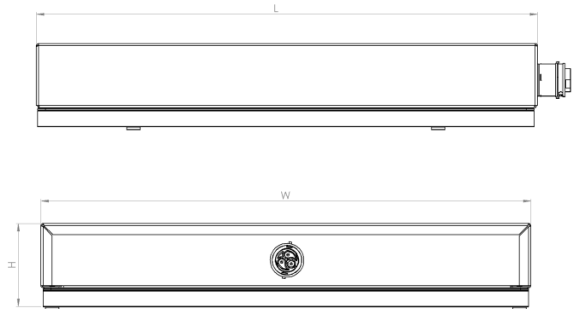

EMERGENCY PACKS

TrustSight PRO 45-300V NiMH	3 hour
Operating Temperature	0 - +40 °C



ISO 9001 - ISO 14001
OHSAS 18001

BUREAU VERITAS
Certification



Ecolight[™]
Save simple.

ELEKTROS TAUPYMO SPRENDIMAI, UAB
Moletu str. 13, Didžioji Riešė (PC "Link Moletu"), Vilnius distr. 14028, Lithuania
Liepu str. 15, Linksmakalnis, Kaunas distr. 53290, Lithuania
E: info@ecolight.lt T: +370 5 2328207 F: +370 5 2784262
W: www.ecolight.lt, www.ecolight-lights.co.uk

THE ENERGY-EFFICIENT HIGH BAY LED LUMINAIRE

Models: SN-EN1/4L/1100, SN-EN1/4L/2000,
SN-EN1/4L/3000

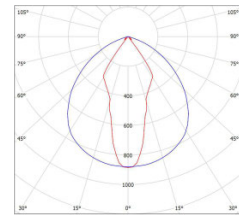

WHEN SIZE AND SHAPE MATTER

These unique models were created for niche industry needs. Uniquely shaped and sized, SAULA LED SN is an ultra-efficient lighting system. Gains in efficiency are obtained through the use of state-of-the-art MIRO reflectors.

Good to know: LED modules are positioned deep in the system to prevent glare.

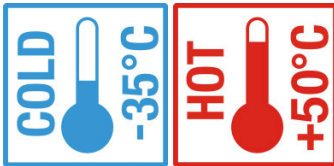

GENERAL TECHNICAL SPECIFICATIONS		Number of LED modules	4
Supply Voltage	220-240V AC	Lamp family code	PHILIPS Fortimo
Supply Frequency	50-60 Hz	Light colour K	3000, 4000, 5000
RFI Suppression	EN 55015 / CISPR 15	Colour Rendering Index	> 80 or > 90
Immunity	EN 61547	Useful life L80B50 at Ta 50 °C	100.000 h
Harmonics	EN 6100-3-2	Driver /power unit/	PHILIPS XITANIUM
Operating Temperature**	-35 - +50 °C	Flickering	IEEE 1789
Storage Temperature	-40 - +60 °C	Power factor (full load at 230V)	> 0.90
Housing material	0.8 mm powder coated steel	Dimmable	Optional
Enclosure Rating	IP65	Emergency pack	Optional
Lid material	PMMA or Polycarbonate	System Wattage	up to 105W
Cable gland	PG 13.5 or STUCCHI (3-pole) fast plug optional	System efficacy at max luminous flux	up to 157 lm/W
Impact Resistance	IK07 or IK09	System luminous flux (max)	up to 16.490 lm

* in preparation

** Only with Xtr drivers. Otherwise from -20 to +50 °C. Operating Temperature limitations for EM options see in next page.

GENERAL TECHNICAL SPECIFICATIONS

EAN	Ref.	Wattage	System efficacy at max luminous flux	System luminous flux (max)	Available Options	Dimensions (mm)			Optimum Working Height
						L	W	H	
4772049000360	SN-EN1/4L/1100	up to 36W	170 lm/W	6.120 lm	S/P/EM/SP/1F/3F	440	430	75	up to 3 m
4772049000377	SN-EN1/4L/2000	up to 68W	157 lm/W	10.675 lm					up to 4 m
4772049004634	SN-EN1/4L/3000	up to 105W	157 lm/W	16.490 lm	S/P/SP/1F/3F				up to 6 m

EAN	Additional options	Ref.
Multiple selection	PIR Sensor (-10/-30 - +35 °C)	S
Multiple selection	PIR and Light Sensor (-10/-30 - +35 °C)	P
4772049001008	Emergency Pack 3h (1h optional)*	EM
4772049001619	Protective Sport Cage	SP
4772049001060	INOX body upgrade	IN
4772049003927	1 phase wiring cables for through-wiring	1F
4772049003934	3 phase wiring cables for through-wiring	3F

* Emergency Pack is not available for powers above 68W.

** There is a possibility to order ready-to-use luminaires with desired length of cable installed.

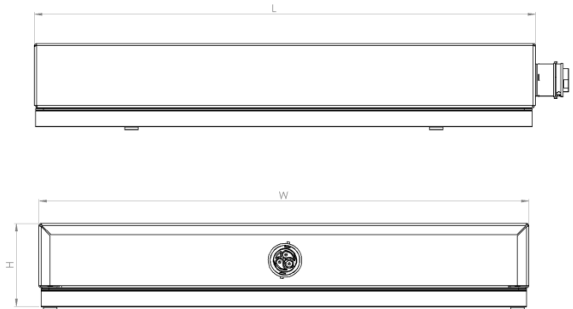

EMERGENCY PACKS

TrustSight PRO 45-300V NiMH	3 hour
Operating Temperature	0 - +40 °C



ISO 9001 - ISO 14001
OHSAS 18001

BUREAU VERITAS
Certification



Ecolight™
Save simple.

ELEKTROS TAUPYMO SPRENDIMAI, UAB
Moletu str. 13, Didžioji Riešė (PC "Link Moletu"), Vilnius distr. 14028, Lithuania
Liepu str. 15, Linksmakalnis, Kaunas distr. 53290, Lithuania
E: info@ecolight.lt T: +370 5 2328207 F: +370 5 2784262
W: www.ecolight.lt, www.ecolight-lights.co.uk

CHAIN OR WIRE SUSPENSION

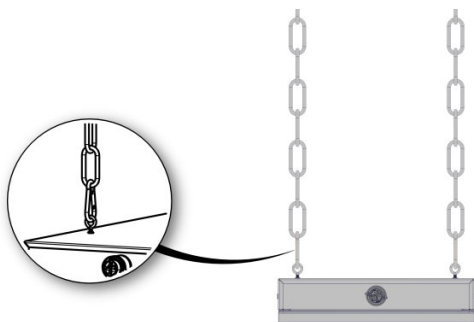

EAN	Ref.	Description
4772049000926	YF12EC500	Y-FIT CLASSIC SNAP-ON HOOK NO.1 (0-10 KG) 2M - LEG LENGTH 500MM
4772049000919	YF12EC300	Y-FIT CLASSIC SNAP-ON HOOK NO.1 (0-10 KG) 2M - LEG LENGTH 300MM
4772049000896	YF12ECS300	Y-FIT CLASSIC MINI SNAP-ON HOOK NO.1 (0-10 KG) 2M - LEG LENGTH 300MM
4772049000902	YF12ECS500	Y-FIT CLASSIC MINI SNAP-ON HOOK NO.1 (0-10 KG) 2M - LEG LENGTH 500MM
4043952670712	99008405	Eye bolts M5
4043952715062	99008407	Carabiner hook M6

STRAIGHT TO CEILING MOUNTING

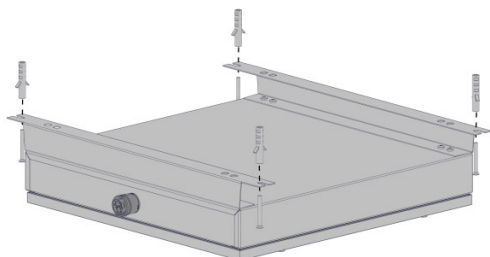

EAN	Description
4772049004320	Straight to ceiling mounting bracket for SW/SN series
4772049004337	Straight to ceiling mounting bracket for SW/SN series (INOX)

SIDE MOUNTING

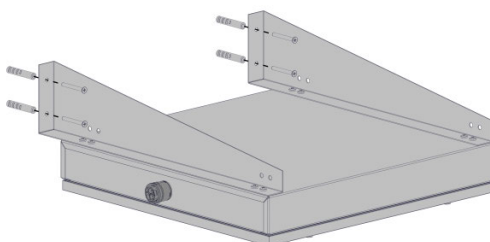

EAN	Description
4772049004344	Side mounting bracket for SAULA SW/SN series
4772049004351	Side mounting bracket for SAULA SW/SN series (INOX)

ADJUSTABLE SIDE MOUNTING

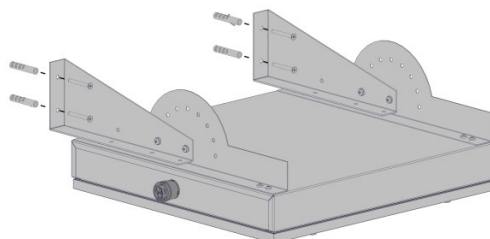

EAN	Description
4772049004368	Adjustable side mounting bracket for SAULA SW/SN series
4772049004375	Adjustable side mounting bracket for SAULA SW/SN series (INOX)

PIPE HOLDER

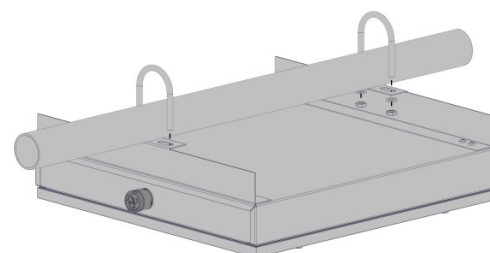

EAN	Description
4772049004382	Pipe holder bracket for SAULA SW/SN series
4772049004399	Pipe holder bracket for SAULA SW/SN series (INOX)



Ecolight[™]
Save simple.

ELEKTROS TAUPYMO SPRENDIMAI, UAB
Moletu str. 13, Didzioji Riese (PC "Link Moletu"), Vilnius distr. 14028, Lithuania
Liepu str. 15, Linksmakalnis, Kaunas distr. 53290, Lithuania
E: info@ecolight.lt T: +370 5 2328207 F: +370 5 2784262
W: www.ecolight.lt, www.ecolight-lights.co.uk

THE ENERGY-EFFICIENT HIGH BAY LED LUMINAIRE

Models: GS-EN1/4L/2000, GS-EN1/6L/2000,
GS-EN1/6L/3000

SAULA LED GS (1FT)

IDEAL SOLUTION FOR PETROL STATIONS

Reassuring, welcoming, clean: this is how a service station appears when illuminated by SAULA LED GS luminaires. An illumination that transmits a natural sensation of light and that prompts drivers to refuel with ease even at night. With clear benefits of the dramatic decrease in energy consumption and maintenance.

Good to know: SAULA LED GS available with different type diffusers to match even very demanding requirements of low glaring and perfect light diffusion.

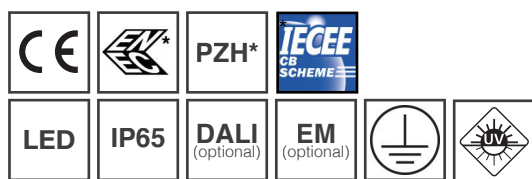
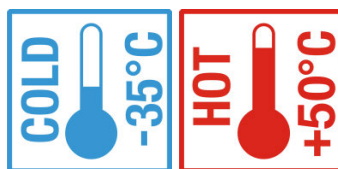
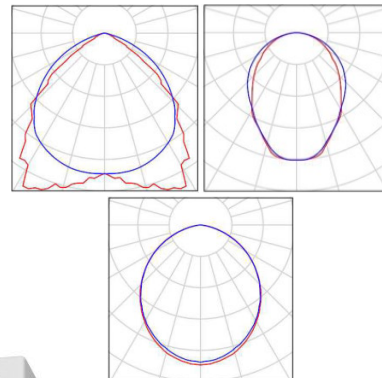

GENERAL TECHNICAL SPECIFICATIONS			
Supply Voltage	220-240V AC	Number of LED modules	4
Supply Frequency	50-60 Hz	Lamp family code	PHILIPS Fortimo
RFI Suppression	EN 55015 / CISPR 15	Light colour K	3000, 4000, 5000
Immunity	EN 61547	Colour Rendering Index	> 80 or > 90
Harmonics	EN 6100-3-2	Useful life L80B50 at Ta 50 °C	100.000 h
Operating Temperature**	-35 - +50 °C	Driver /power unit/	PHILIPS XITANIUM
Storage Temperature	-40 - +60 °C	Flickering	IEEE 1789
Housing material	0.8 mm powder coated steel	Power factor (full load at 230V)	> 0.90
Enclosure Rating	IP65	Dimmable	Optional
Lid material	PMMA, Polycarbonate or Tempered Glass	System Wattage	up to 150W
Cable gland	PG 13.5 or STUCCHI (3-pole) fast plug optional	System efficacy at max luminous flux	up to 160 lm/W
Impact Resistance	IK07 or IK09	System luminous flux (max)	up to 24.000 lm

* in preparation

** Only with Xtr drivers. Otherwise from -20 to +50 °C.

GENERAL TECHNICAL SPECIFICATIONS

EAN	Ref.	Wattage	System efficacy at max luminous flux	System luminous flux (max)	Available Options	Luminaire dimensions (mm)			Frame dimensions (mm)		
						L	W	H	L	W	H
4772049002180	GS-EN1/4L/2000	up to 68W	157 lm/W	10.675 lm	S/P/EM/IN/1F/3F	470	470	100	554	554	150
4772049002197	GS-EN1/4L/3000	up to 105W	157 lm/W	16.490 lm							
4772049004405	GS-EN1/6L/3000	up to 150W	160 lm/W	24.000 lm	S/P/IN/1F/3F						

EAN	Additional options	Ref.
Multiple selection	PIR Sensor (-10 - +35 °C)	S
Multiple selection	PIR and Light Sensor (-10 - +35 °C)	P
4772049001008	Emergency Pack 3h (1h optional)*	EM
4772049001060	INOX body upgrade	IN
4772049003927	1 phase wiring cables for through-wiring	1F
4772049003934	3 phase wiring cables for through-wiring	3F

* Emergency Pack is not available for powers above 105W.

** There is a possibility to order ready-to-use luminaires with desired length of cable installed.

EMERGENCY PACKS

TrustSight PRO 45-300V NiMH	3 hour
Operating Temperature	0 - +40 °C



ISO 9001 - ISO 14001
OHSAS 18001

BUREAU VERITAS
Certification



Ecolight™
Save simple.

ELEKTROS TAUPYMO SPRENDIMAI, UAB
Moletu str. 13, Didžioji Riešė (PC "Link Moletu"), Vilnius distr. 14028, Lithuania
Liepu str. 15, Linksmakalnis, Kaunas distr. 53290, Lithuania
E: info@ecolight.lt T: +370 5 2328207 F: +370 5 2784262
W: www.ecolight.lt, www.ecolight-lights.co.uk

THE ENERGY-EFFICIENT HIGH BAY LED LUMINAIRE

Models: GS-EN2/2L/4000, GS-EN2/2L/6000, GS-EN2/3L/6000

IDEAL SOLUTION FOR PETROL STATIONS

Reassuring, welcoming, clean: this is how a service station appears when illuminated by SAULA LED GS luminaires. An illumination that transmits a natural sensation of light and that prompts drivers to refuel with ease even at night. With clear benefits of the dramatic decrease in energy consumption and maintenance.

Good to know: SAULA LED GS available with different type diffusers to match even very demanding requirements of low glaring and perfect light diffusion.

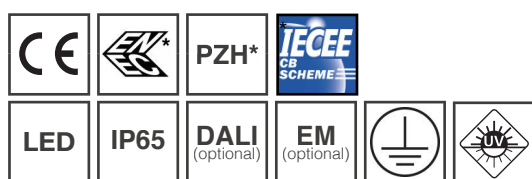
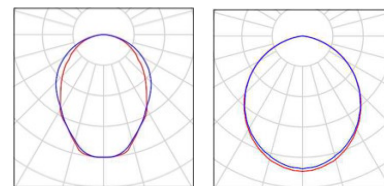
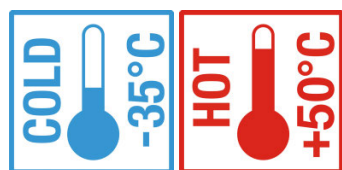

GENERAL TECHNICAL SPECIFICATIONS			
Supply Voltage	220-240V AC	Number of LED modules	2, 3 or 4
Supply Frequency	50-60 Hz	Lamp family code	PHILIPS Fortimo
RFI Suppression	EN 55015 / CISPR 15	Light colour K	3000, 4000, 5000
Immunity	EN 61547	Colour Rendering Index	> 80 or > 90
Harmonics	EN 6100-3-2	Useful life L80B50 at Ta 50 °C	100.000 h
Operating Temperature**	-35 - +50 °C	Driver /power unit/	PHILIPS XITANIUM
Storage Temperature	-40 - +60 °C	Flickering	IEEE 1789
Housing material	0.8 mm powder coated steel	Power factor (full load at 230V)	> 0.90
Enclosure Rating	IP65	Dimmable	Optional
Lid material	PMMA, Polycarbonate or Tempered Glass	System Wattage	up to 150W
Cable gland	PG 13.5 or STUCCHI (3-pole) fast plug optional	System efficacy at max luminous flux	up to 160 lm/W
Impact Resistance	IK07 or IK09	System luminous flux (max)	up to 24.000 lm

* in preparation

** Only with Xtr drivers. Otherwise from -20 to +50 °C.

GENERAL TECHNICAL SPECIFICATIONS

EAN	Ref.	Wattage	System efficacy at max luminous flux	System luminous flux (max)	Available Options	Luminaire dimensions (mm)			Frame dimensions (mm)		
						L	W	H	L	W	H
4772049002814	GS-EN2/2L/4000	up to 72W	155 lm/W	11.160 lm	S/P/EM/1F/3F	585	305	100	670	390	150
4772049002821	GS-EN2/2L/6000	up to 105W	157 lm/W	16.490 lm							
4772049002838	GS-EN2/3L/6000	up to 150W	160 lm/W	24.000 lm	S/P/1F/3F						

EAN	Additional options	Ref.
Multiple selection	PIR Sensor (-10 - +35 °C)	S
Multiple selection	PIR and Light Sensor (-10 - +35 °C)	P
4772049001008	Emergency Pack 3h (1h optional)*	EM
4772049001060	INOX body upgrade	IN
4772049003927	1 phase wiring cables for through-wiring	1F
4772049003934	3 phase wiring cables for through-wiring	3F

* Emergency Pack is not available for powers above 105W.
 ** There is a possibility to order ready-to-use luminaires with desired length of cable installed.

EMERGENCY PACKS

TrustSight PRO 45-300V NiMH	3 hour
Operating Temperature	0 - +40 °C



ISO 9001 - ISO 14001
OHSAS 18001

BUREAU VERITAS
Certification



ELEKTROS TAUPYMO SPRENDIMAI, UAB
 Moletu str. 13, Didzioji Riese (PC "Link Moletu"), Vilnius distr. 14028, Lithuania
 Liepu str. 15, Linksmakainis, Kaunas distr. 53290, Lithuania
 E: info@ecolight.lt T: +370 5 2328207 F: +370 5 2784262
 W: www.ecolight.lt, www.ecolight-lights.co.uk

THE ENERGY-EFFICIENT HIGH BAY LED LUMINAIRE

Models: EC-EN2/4L/2200, EC-EN2/4L/4000, EC-EN2/4L/6000,
EC-EN4/3L/12000, EC-EN4/4L/12000

ECOLINE
LED EC

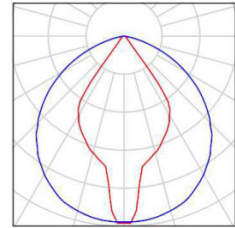

LOW-COST OPTION FOR WAREHOUSES

ECOLINE LED EC luminaire was designed specifically for the illumination of warehouse spaces. Cost-efficiency gains were obtained by cutting redundant functions and features. Warehouse illumination does not require IP65 rating, so they were reduced to IP40. A simplified structure still permits great thermal characteristics. ECOLINE LED EC can be used in temperatures up to + 50°C.

Good to know: ECOLINE LED EC was designed to give the optimal light for both the hallway and the shelving racks.

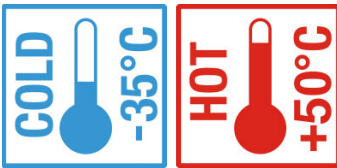

GENERAL TECHNICAL SPECIFICATIONS		Number of LED modules	4
Supply Voltage	220-240V AC	Lamp family code	PHILIPS Fortimo
Supply Frequency	50-60 Hz	Light colour K	3000, 4000, 5000
RFI Suppression	EN 55015 / CISPR 15	Colour Rendering Index	> 80 or > 90
Immunity	EN 61547	Useful life L80B50 at Ta 50 °C	100.000 h
Harmonics	EN 6100-3-2	Driver /power unit/	PHILIPS XITANIUM
Operating Temperature**	-35 - +50 °C	Flickering	IEEE 1789
Storage Temperature	-40 - +60 °C	Power factor (full load at 230V)	> 0.90
Housing material	0.8 mm powder coated steel	Dimmable	Optional
Enclosure Rating	IP40	Emergency pack	Optional
Lid material	PMMA or Polycarbonate	System Wattage	up to 210W
Cable gland	PG 13.5 or STUCCHI (3-pole) fast plug optional	System efficacy at max luminous flux	157 lm
Protection class IEC	Safety class I	System luminous flux (max)	32.970 lm

* in preparation

** Only with Xtr drivers. Otherwise from -20 to +35 °C. Operating Temperature limitations for EM options see in next page.

GENERAL TECHNICAL SPECIFICATIONS

EAN	Ref.	Wattage	System efficacy at max luminous flux	System luminous flux (max)	Available Options	Dimensions (mm)**			Optimum Working Height
						L	W	H	
4772049000131	EC-EN2/4L/2200	up to 68W	170 lm/W	11.560 lm	S/P/SP/EM/1F/3F	640	385	75	up to 10 m
4772049000124	EC-EN2/4L/4000	up to 128W	160 lm/W	20.480 lm					up to 15 m
47720490004412	EC-EN2/4L/6000*	up to 210W	157 lm/W	32.970 lm					up to 20 m
4772049000100	EC-EN4/3L/4400	up to 100W	176 lm/W	17.600 lm	S/P/SP/EM/1F/3F	1205	295	75	up to 10 m
4772049000117	EC-EN4/3L/8000	up to 200W	160 lm/W	32.000 lm					up to 15 m
47720490004429	EC-EN4/3L/12000*	up to 300W	160 lm/W	48.000 lm					up to 20 m
4772049000148	EC-EN4/4L/4400	up to 134W	176 lm/W	23.580 lm	S/P/SP/EM/1F/3F	1205	385	75	up to 10 m
4772049000155	EC-EN4/4L/8000	up to 255W	160 lm/W	38.400 lm					up to 15 m
47720490004436	EC-EN4/4L/12000*	up to 350W	164 lm/W	57.400 lm					up to 20 m

* not incl. in certificates yet (only CE). ** without sensor.

EAN	Additional options	Ref.
Multiple selection	PIR Sensor (-10/-30 - +35 °C)	S
Multiple selection	PIR and Light Sensor (-10/-30 - +35 °C)	P
4772049001008	Emergency Pack 3h (1h optional)*	EM
4772049001596	Protective Sport Cage	SP
4772049001060	INOX body upgrade	IN
4772049003927	1 phase wiring cables for through-wiring	1F
4772049003934	3 phase wiring cables for through-wiring	3F

* Emergency Pack is not available for powers above 128W.
 ** There is a possibility to order ready-to-use luminaires with desired length of cable installed.

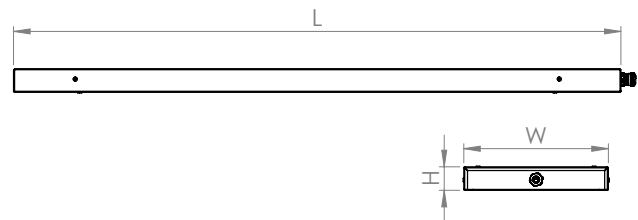

EMERGENCY PACKS

TrustSight PRO 45-300V NiMH	3 hour
Operating Temperature	0 - +40 °C



ISO 9001 - ISO 14001
OHSAS 18001

BUREAU VERITAS
Certification



ELEKTROS TAUPYMO SPRENDIMAI, UAB
 Moletu str. 13, Didzioji Riese (PC "Link Moletu"), Vilnius distr. 14028, Lithuania
 Liepu str. 15, Linksmakalnis, Kaunas distr. 53290, Lithuania
 E: info@ecolight.lt T: +370 5 2328207 F: +370 5 2784262
 W: www.ecolight.lt, www.ecolight-lights.co.uk

CHAIN OR WIRE SUSPENSION

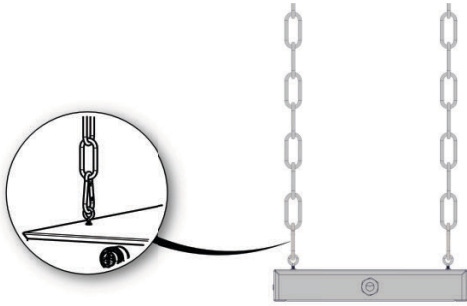

EAN	Ref.	Description
4772049000926	YF12EC500	Y-FIT CLASSIC SNAP-ON HOOK NO.1 (0-10 KG) 2M - LEG LENGTH 500MM
4772049000919	YF12EC300	Y-FIT CLASSIC SNAP-ON HOOK NO.1 (0-10 KG) 2M - LEG LENGTH 300MM
4772049000896	YF12ECS300	Y-FIT CLASSIC MINI SNAP-ON HOOK NO.1 (0-10 KG) 2M - LEG LENGTH 300MM
4772049000902	YF12ECS500	Y-FIT CLASSIC MINI SNAP-ON HOOK NO.1 (0-10 KG) 2M - LEG LENGTH 500MM
4043952670712	99008405	Eye bolts M5
4043952715062	99008407	Carabiner hook M6

STRAIGHT TO CEILING MOUNTING

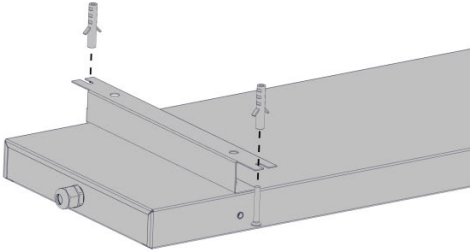

EAN	Description
4772049004443	Straight to ceiling mounting bracket for 4L ECOLINE EC series
4772049004467	Straight to ceiling mounting bracket for 3L ECOLINE EC series
4772049004450	Straight to ceiling mounting bracket for 4L ECOLINE EC series (INOX)
4772049004474	Straight to ceiling mounting bracket for 3L ECOLINE EC series (INOX)

SIDE MOUNTING

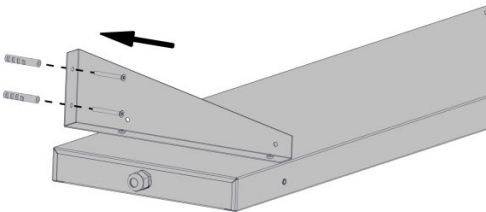

EAN	Description
4772049004481	Side mounting bracket for 4L ECOLINE EC series
4772049004504	Side mounting bracket for 3L ECOLINE EC series
4772049004498	Side mounting bracket for 4L ECOLINE EC series (INOX)
4772049004511	Side mounting bracket for 3L ECOLINE EC series (INOX)

ADJUSTABLE SIDE MOUNTING

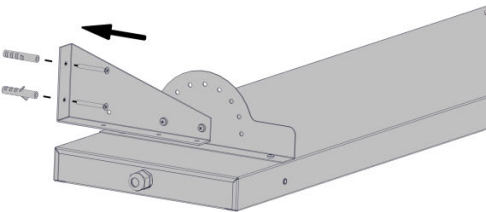

EAN	Description
4772049004528	Adjustable side mounting bracket for 4L ECOLINE EC series
4772049004542	Adjustable side mounting bracket for 3L ECOLINE EC series
4772049004535	Adjustable side mounting bracket for 4L ECOLINE EC series (INOX)
4772049004559	Adjustable side mounting bracket for 3L ECOLINE EC series (INOX)

PIPE HOLDER

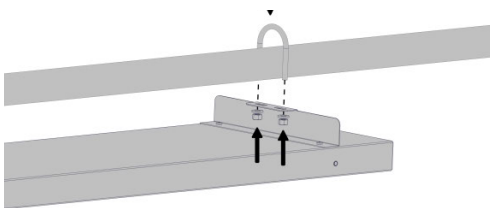

EAN	Description
4772049004566	Pipe holding bracket for 4L ECOLINE EC series
4772049004580	Pipe holding bracket for 3L ECOLINE EC series
4772049004573	Pipe holding bracket for 4L ECOLINE EC series (INOX)
4772049004597	Pipe holding bracket for 3L ECOLINE EC series (INOX)



Ecolight™
Save simple.

ELEKTROS TAUPYMO SPRENDIMAI, UAB
Moletu str. 13, Didzioji Riese (PC "Link Moletu"), Vilnius distr. 14028, Lithuania
Liepu str. 15, Linksmakalnis, Kaunas distr. 53290, Lithuania
E: info@ecolight.lt T: +370 5 2328207 F: +370 5 2784262
W: www.ecolight.lt, www.ecolight-lights.co.uk

THE ENERGY-EFFICIENT LOW BAY LED LUMINAIRE

Models: LP-EN2/2SQ/2500, LP-EN4/2SQ/2500

SAULA LED LP

LED LIGHTING SOLUTION FOR SUSPENDED CEILINGS

SAULA LED LP is a system for suspended ceilings type Armstrong. Application areas include hospitals, healthcare premises, laboratories, etc. The system is designed to be used in heights ranging from 2 to 5 meters.

Good to know: SAULA LED LP is an IP65 luminaire.

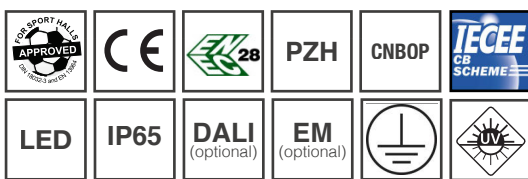
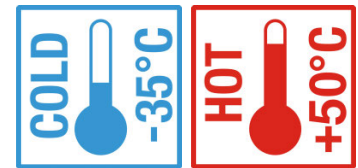
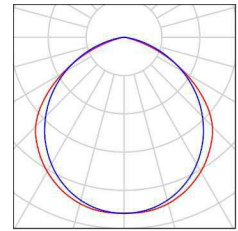

GENERAL TECHNICAL SPECIFICATIONS			
Supply Voltage	220-240V AC	Number of LED modules	2
Supply Frequency	50-60 Hz	Lamp family code	PHILIPS Fortimo LED
RFI Suppression	EN 55015 / CISPR 15	Light colour K	3000, 4000 or 6500
Immunity	EN 61547	Colour Rendering Index	> 80
Harmonics	EN 6100-3-2	Useful life L80B50 at Ta 50 °C	54.000 h
Operating Temperature*	-35 - +50 °C	Driver /power unit/	PHILIPS XITANIUM
Storage Temperature	-40 - +60 °C	Flickering	IEEE 1789
Housing material	0.8 mm powder coated steel	Power factor (full load at 230V)	> 0.90
Enclosure Rating	IP65	Dimmable	Optional
Lid material	Opal PMMA or Opal Polycarbonate	Emergency pack	Optional
Cable gland	PG 13.5 or STUCCHI (3-pole) fast plug optional	System Wattage	up to 70W
Protection class IEC	Safety class I	System efficacy at max luminous flux	up to 155 lm/W
		System luminous flux (max)	up to 10.850 lm

* Only with Xtr drivers. Otherwise from -20 to +50 °C. Operating Temperature limitations for EM options see in next page.

GENERAL TECHNICAL SPECIFICATIONS

EAN	Ref.	Wattage	System efficacy at max luminous flux	System luminous flux (max)	Available Options	Dimensions (mm)			Optimum Working Height
						L	W	H	
4772049000568	LP-EN2/2SQ/2500	up to 35W	168 lm/W	5.880 lm	P/S/EM/1F/3F	595	595	60	up to 5 m
4772049000575	LP-EN2/2SQ/2500	up to 55W	159 lm/W	8.745 lm					
4772049000575	LP-EN2/2SQ/2500	up to 70W	155 lm/W	10.850 lm					
4772049000582	LP-EN4/2SQ/2500	up to 35W	168 lm/W	5.880 lm		1195	295	60	
4772049000599	LP-EN4/2SQ/2500	up to 55W	159 lm/W	8.745 lm					
4772049000599	LP-EN4/2SQ/2500	up to 70W	155 lm/W	10.850 lm					

EAN	Additional options	Ref.
Multiple selection	PIR Sensor (-10/-30 - +35 °C)	S
Multiple selection	PIR and Light Sensor (-10/-30 - +35 °C)	P
4772049001008	Emergency Pack 3h (1h optional)	EM
4772049003927	1 phase wiring cables for through-wiring	1F
4772049003934	3 phase wiring cables for through-wiring	3F

There is a possibility to order ready-to-use luminaires with desired length of cable installed.

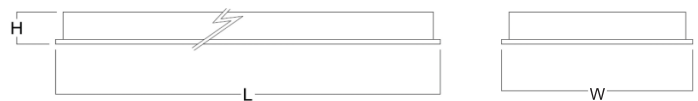

ACCESSORIES

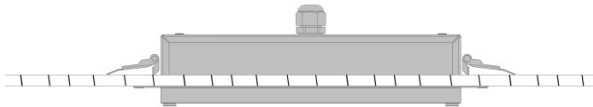
EAN	Description	Picture
4772049004603	False ceiling mounting clamps	

EMERGENCY PACKS

TrustSight PRO 45-300V NiMH	3 hour
Operating Temperature	0 - +40 °C



ISO 9001 - ISO 14001
OHSAS 18001

BUREAU VERITAS
Certification



ELEKTROS TAUPYMO SPRENDIMAI, UAB
Moletu str. 13, Didzioji Riese (PC "Link Moletu"), Vilnius distr. 14028, Lithuania
Liepu str. 15, Linksmakalnis, Kaunas distr. 53290, Lithuania
E: info@ecolight.lt T: +370 5 2328207 F: +370 5 2784262
W: www.ecolight.lt, www.ecolight-lights.co.uk

SKY PANEL SL-PAN SQUARE

THE ENERGY-EFFICIENT LOW BAY LED LUMINAIRE

Model: SL-PAN SQUARE

THE SMART CHOICE FOR OFFICE APPLICATIONS

SKY PANEL LED is a premium lighting system meeting the highest standards of functionality and safety. SKY PANEL LED may be powered by high quality Philips Xitanium, Tridonic or Osram drivers. This means that the system has a great power factor and is flicker free. What's more, SKY PANEL LED can be a low glare luminaire (optional).

Good to know: SKY PANEL LED is being certified for IECCE CB.

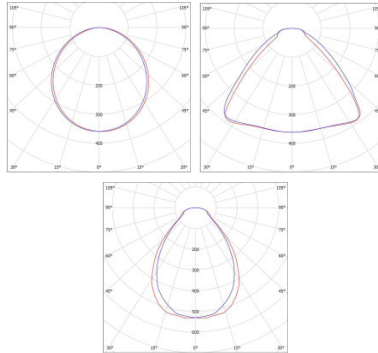

**Tunable
White**
LUMINAIRES

OPTION AVAILABLE

CE	PZH*	IECEE CB SCHEME	CNBOP*
LED	IP40	DALI (optional)	EM (optional)

GENERAL TECHNICAL SPECIFICATIONS

Supply Voltage	220-240V AC
Supply Frequency	50-60 Hz
RFI Suppression	EN 55015 / CISPR 15
Immunity	EN 61547
Harmonics	EN 6100-3-2
Operating Temperature	-25 - +25 °C
Storage Temperature	-40 - +60 °C
Housing Material	Aluminium
Diffuser	Opal or micro-prismatic
Protection against mechanical impact	IK05

Beam Spread	120 or 90 deg.
UGR	<19 (optional)
Light colour K	2700 - 6500K
Colour Rendering Index	> 80
Useful life L80B50 at Ta 25 °C	50.000 h**
Driver /power unit/	Philips Xitanium or Tridonic
Flickering	IEEE 1789
Power Factor (full load at 230V)	> 0.90
Dimmable	Optional
Emergency Pack	Optional
System Wattage	up to 60W
System efficacy at max luminous flux	up to 116 lm/W

* In preparation; ** only Fortimo model

GENERAL TECHNICAL SPECIFICATIONS

EAN	Model	Part Number	Power	Lumens	Dimensions (mm)
4772049002975	SKY PANEL CertaFlux LED Panel 6060 3590 lm MD2	SL-PAN-41W-XW-AN-S	41	3590	595 x 595
4772049003347	SKY PANEL CertaFlux LED Panel 6060 3290 lm UC MD2	SL-PAN-41W-XW-AN-S-MP	41	3290	595 x 595
4772049002982	SKY PANEL Fortimo LED Panel 6060 4520lm MD2	SL-PAN-41W-XW-AN-MP	41	4520	595 x 595
4772049002982	SKY PANEL Fortimo LED Panel 6060 3950lm MD2	SL-PAN-36W-XW-AN-MP	36	3950	595 x 595
4772049003361	SKY PANEL CertaFlux LED Panel 6262 3590 lm MD2	SL-PAN-41W-XW-LS-S	41	3590	620 x 620
4772049002999	SKY PANEL Fortimo LED Panel 6262 4520lm MD2	SL-PAN-41W-XW-LS-MP	41	4520	620 x 620
4772049002999	SKY PANEL Fortimo LED Panel 6262 3950lm MD2	SL-PAN-36W-XW-LS-MP	36	3950	620 x 620
4772049003392	SKY PANEL CertaFlux LED Panel 30120 3590 lm MD2	SL-PAN-41W-XW-BN-S	41	3590	295 x 1195
4772049003415	SKY PANEL CertaFlux LED Panel 30120 3290 lm UC MD2	SL-PAN-41W-XW-BN-S-MP	41	3290	295 x 1195
4772049003439	SKY PANEL Fortimo LED Panel 30120 4520lm MD2	SL-PAN-41W-XW-BN-MP	41	4520	295 x 1195
4772049003439	SKY PANEL Fortimo LED Panel 30120 3950lm MD2	SL-PAN-36W-XW-BN-MP	36	3950	295 x 1195
4772049003453	SKY PANEL CertaFlux LED Panel 60120 6250lm MD2	SL-PAN-60W-XW-LS-S	60	6250	595 x 1195
4772049003477	SKY PANEL CertaFlux LED Panel 60120 5810lm UC MD2	SL-PAN-60W-XW-LS-S-MP	60	5810	595 x 1195
4772049003507	SKY PANEL Fortimo LED Panel 60120 6950lm MD2	SL-PAN-60W-XW-LS-MP	60	6950	595 x 1195
4772049002791	SKY PANEL CTA 3000K - 5700K 600x600 mm 40W	SL-PAN-40W-BW-AN	40	4000	595 x 595



Type reference product key code: SL-PAN-aW-bW-c-d

a = means rating power (6, 8, 12, 15, 20, 24, 25, 26, 30, 34, 35, 36, 38, 40, 45, 50, 55, 60, 65 or 70)

b = means colour temperature (S = 2700K ±200K; W = 3000 ±200K; N = 4000 ±250K; D = 5000 ±300K; P = 6000 ±350K; C = 6500 ±500K)

c = means profile type (AN, BN, LN, LS, LY UD, XS, R2.5, R4, R6, R8, R60, PA, SM, PX90, PX120, PX150, AN2, BN2, LN2 LS2, FIO, BS or BS2)

d = optional version (S, S2, D, PC, EM, MP, TP, UD, WH, SI, BK or DALI)

EAN	Description	Picture
4772049000711	Adjustable stainless steel wiring suspension kit for Sky Panels	
4772049000742	Ceiling mounting bracket kit for 600 x 600 Sky Panels	
4772049000728	Ceiling mounting bracket kit for 300 x 1200 Sky Panels	
4772049004603	False ceiling mounting clamps	

EMERGENCY PACKS

TrustSight PRO 45-300V NiMH	3 hour
Operating Temperature	0 - +40 °C



ISO 9001 - ISO 14001
OHSAS 18001

BUREAU VERITAS
Certification



EcolightTM
Save simple.

ELEKTROS TAUPYMO SPRENDIMAI, UAB
Moletu str. 13, Didzioji Riese (PC "Link Moletu"), Vilnius distr. 14028, Lithuania
Liepu str. 15, Linksmakalnis, Kaunas distr. 53290, Lithuania
E: info@ecolight.lt T: +370 5 2328207 F: +370 5 2784262
W: www.ecolight.lt, www.ecolight-lights.co.uk

SKY PANEL SL-PAN ROUND

THE ENERGY-EFFICIENT LOW BAY LED LUMINAIRE

Model: SL-PAN ROUND

THE SMART CHOICE FOR OFFICE APPLICATIONS

SKY PANEL LED is a premium lighting system meeting the highest standards of functionality and safety. SKY PANEL LED may be powered by high quality Philips Xitanium, Tridonic, Osram or Meanwell drivers. This means that the system has a great power factor and is flicker free.

Good to know: SKY PANEL LED is being certified for IECEE CB.

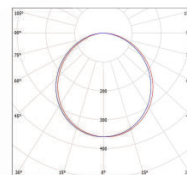

CE	PZH*	IECEE CB SCHEME	CNBOP*		
LED	IP40	IP42	IP44	EM (optional)	DALI (optional)

GENERAL TECHNICAL SPECIFICATIONS	
Supply Voltage	220-240V AC
Supply Frequency	50-60 Hz
RFI Suppression	EN 55015 / CISPR 15
Immunity	EN 61547
Harmonics	EN 6100-3-2
Operating Temperature	-25 - +35 °C
Storage Temperature	-40 - +60 °C
Housing Material	Aluminum
Diffuser	Opal
Protection against mechanical impact	IK05

Beam Spread	120
Light colour K	2700 - 6500K
Colour Rendering Index	> 80
Useful life L80B50 at Ta 25 °C	50.000 h
Driver /power unit/	Philips, Osram, Tridonic or Meanwell
Flickering	IEEE 1789
Power Factor (full load at 230V)	> 0.90
Dimmable	Optional
Emergency Pack	Optional
System Wattage	up to 60W
System efficacy at max luminous flux	up to 95 lm/W

* in preparation

GENERAL TECHNICAL SPECIFICATIONS

EAN	Model	Part Number	Power	Lumens	Dimensions (mm)
4772049003033	R2.5	SL-PAN-08W-xW-R2.5	8W	400	diam 93*12 CutOut: diam 68
4772049003040	R4	SL-PAN-08W-xW-R4	8W	750	diam 145*12 CutOut: diam 125
4772049003057	R6	SL-PAN-15W-xW-R6	15W	1420	diam 180*12 CutOut: diam 160
4772049003064	R8	SL-PAN-24W-xW-R8	24W	2280	diam 240*12 CutOut: diam 220
4772049004726	R30	SL-PAN-24W-xW-R30	24W	2280	diam 300*12 CutOut: diam 280
4772049004733	S30	SL-PAN-25W-xW-S30	24W	2280	diam 300 x 38
4772049003071	R60	SL-PAN-40W-xW-R60	40W	3800	diam 580 x 15
4772049003088		SL-PAN-40W-xW-R60-UD-TP	40W	3800	diam 580 x 15
4772049003095		SL-PAN-60W-xW-R60	60W	5700	diam 580 x 15
4772049003101		SL-PAN-60W-xW-R60-UD-TP	60W	5700	diam 580 x 15
4772049003118	Lily	SL-PAN-26W-xW-LY	26W	2470	diam 380 x 15
4772049003125		SL-PAN-36W-xW-LY	36W	3420	diam 380 x 15

Type reference product key code: SL-PAN-aW-bW-c-d

a = means rating power (6, 8, 12, 15, 20, 24, 25, 26, 30, 34, 35, 36, 38, 40, 45, 50, 55, 60, 65 or 70)
 b = means colour temperature (S = 2700K ±200K; W = 3000 ±200K; N = 4000 ±250K; D = 5000 ±300K; P = 6000 ±350K; C = 6500 ±500K)
 c = means profile type (AN, BN, LN, LS, LY UD, XS, R2.5, R4, R6, R8, S30, R60, PA, SM, PX90, PX120, PX150, AN2, BN2, LN2 LS2, FIO, BS or BS2)
 d = optional version (S, S2, D, PC, EM, MP, TP, UD, WH, SI, BK or DALI)

EMERGENCY PACKS

TrustSight PRO 45-300V NiMH	3 hour
Operating Temperature	0 - +40 °C



LED Luminaires
and Retrofit Bulbs
Licensing Program

Member
ECOLIGHT.
Save simple

**ISO 9001 - ISO 14001
OHSAS 18001**

**BUREAU VERITAS
Certification**



Ecolight™
Save simple.

ELEKTROS TAUPYMO SPRENDIMAI, UAB
 Moletu str. 13, Didzioji Riese (PC "Link Moletu"), Vilnius distr. 14028, Lithuania
 Liepu str. 15, Linksmakalnis, Kaunas distr. 53290, Lithuania
 E: info@ecolight.lt T: +370 5 2328207 F: +370 5 2784262
 W: www.ecolight.lt, www.ecolight-lights.co.uk

LINAS OFFICE LED LO

THE ENERGY-EFFICIENT LOW BAY LED LUMINAIRE LINAS OFFICE

Models: multiple selection (see other page).

LINEAR LIGHTING SOLUTION FOR OFFICES

The LINAS OFFICE is designed to replace outdated, flickering, traditional fluorescent fixtures with a brighter, more energy efficient and modern LED batten fixture. Delivering over 130 Lm/W efficacy, it is ultra-reliable and will be noticeably brighter than the old lighting it is replacing. The LINAS OFFICE range can be specified with the latest LED Tuneable White technology, giving the user the freedom to select any colour temperature between 2700K and 6500K. Moreover LINAS OFFICE might be equipped with the latest Cyan Enhanced Static (CES) technology from Philips which helps human body to suppress the creation of the sleep hormone melatonin (for more information please read next pages). With all these features LINAS OFFICE is ideal for premium office work spaces. It can be suspended (using a suspension kit) or ceiling mounted.

Good to know: when specified with direct/indirect light distribution, suspended LINAS OFFICE lighting is a perfect choice for LG7 office schemes.

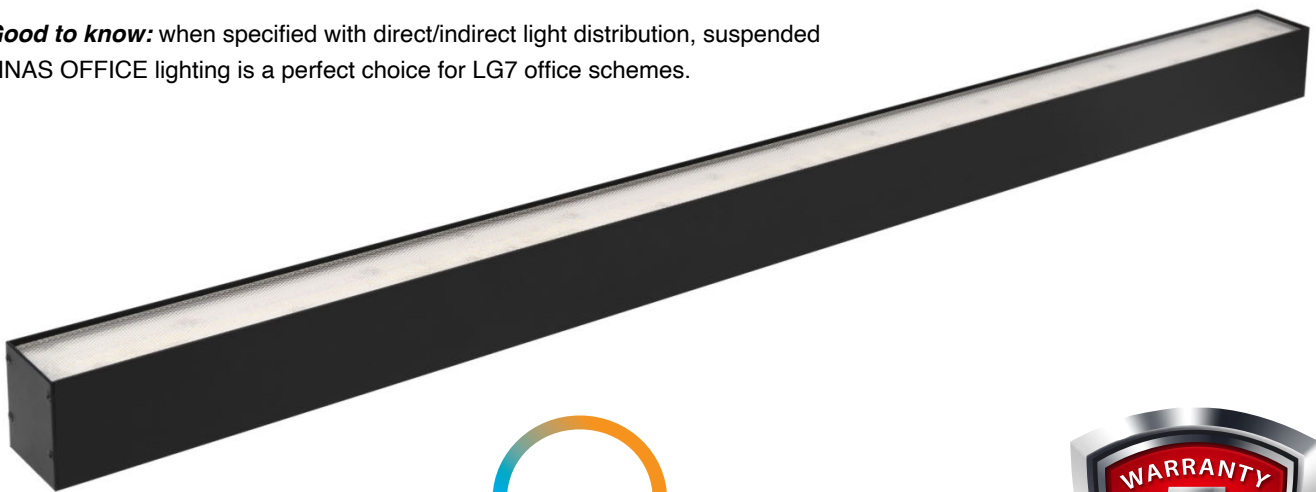
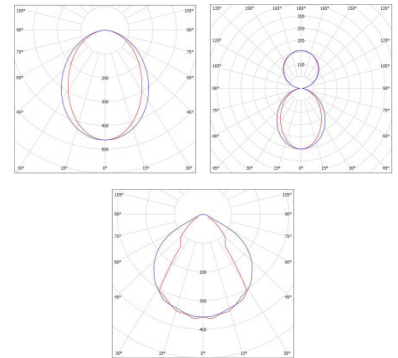

**Tunable
White**
LUMINAIRES
OPTION AVAILABLE



GENERAL TECHNICAL SPECIFICATIONS			
Supply Voltage	220-240V AC	Number of LED modules	2 - 7
Supply Frequency	50-60 Hz	Lamp Family Code	Philips Fortimo or Tridonic
RFI Suppression	EN 55015 / CISPR 15	Light colour K	3000, 4000 or 5000
Immunity	EN 61547	Colour Rendering Index	> 80 or > 90
Harmonics	EN 6100-3-2	Useful life L80B50 at Ta 35 °C	70.000 h
Operating Temperature	-20 - +35 °C	Driver /power unit/	Philips Xitanium or Tridonic
Storage Temperature	-40 - +60 °C	Flickering	IEEE 1789
Housing Material	Anodised aluminum	Power Factor (full load at 230V)	> 0.90
Diffuser	Opal PMMA or DiamondPRISM (optional)	Driver efficiency	> 90%
Suspension	4772049002807 Y-FIT	Dimmable	Optional
Water and Dust Resistance	IP20 or IP44 (optional)	Emergency Pack	Optional
Light outlet	Direct, Direct/indirect	System Wattage	up to 155W
Protection class IEC	Safety class I & II	System efficacy at max luminous flux	up to 125 lm/W
		System luminous flux (max)	21.750 lm

* in preparation

GENERAL TECHNICAL SPECIFICATIONS (SUSPENDED VERSION)

EAN	Ref.	Wattage	System efficacy at max luminous flux	System luminous flux (max)	Available Options	Length (mm)
4772049003323	LO-EN2/1L/2200	20	130	2600	S/M/PN/CES	568
4772049003330	LO-EN2/1L/2200/1100	30	145	4350	S/M/PN/CES	568
4772049002883	LO-EN3/1L/3300	30	145	4350	S/M/EM/PN/CES	849
4772049003354	LO-EN3/1L/3300	35	125	4375	S/M/EM/PN/CES	849
4772049003378	LO-EN3/1L/3300/1100	40	145	5800	S/M/EM/PN/CES	849
4772049003385	LO-EN3/1L/3300/1100	45	125	5625	S/M/EM/PN/CES	849
4772049002326	LO-EN4/1L/4400	40	145	5800	S/M/EM/PN/CES	1129
4772049003408	LO-EN4/1L/4400	45	125	5625	S/M/EM/PN/CES	1129
4772049002388	LO-EN4/1L/4400/2200	60	145	8700	S/M/EM/PN/CES	1129
4772049003422	LO-EN4/1L/4400/2200	65	125	8125	S/M/EM/PN/CES	1129
4772049002357	LO-EN5/1L/5500	50	145	7250	S/M/EM/PN/CES	1410
4772049003446	LO-EN5/1L/5500	55	125	6875	S/M/EM/PN/CES	1410
4772049002418	LO-EN5/1L/5500/2200	50	145	7250	S/M/EM/PN/CES	1410
4772049003460	LO-EN5/1L/5500/2200	75	125	9375	S/M/EM/PN/CES	1410
4772049003484	LO-EN6/1L/6600	60	145	8700	S/M/EM/PN/CES	1690
4772049003491	LO-EN6/1L/6600	65	125	8125	S/M/EM/PN/CES	1690
4772049003514	LO-EN6/1L/6600/3300	90	145	13050	S/M/EM/PN/CES	1690
4772049003521	LO-EN6/1L/6600/3300	95	125	11875	S/M/EM/PN/CES	1690
4772049003545	LO-EN7/1L/7700	70	145	10150	S/M/EM/PN/CES	1971
4772049003552	LO-EN7/1L/7700	75	125	9375	S/M/EM/PN/CES	1971
4772049003576	LO-EN7/1L/7700/3300	100	145	14500	S/M/EM/PN/CES	1971
4772049003583	LO-EN7/1L/7700/3300	105	125	13125	S/M/EM/PN/CES	1971
4772049003606	LO-EN8/1L/8800	145	145	21025	S/M/EM/PN/CES	2251
4772049003613	LO-EN8/1L/8800	85	125	10625	S/M/EM/PN/CES	2251
4772049003637	LO-EN8/1L/8800/4400	120	145	17400	S/M/EM/PN/CES	2251
4772049003644	LO-EN8/1L/8800/4400	125	125	15625	S/M/EM/PN/CES	2251
4772049003668	LO-EN9/1L/9900	90	145	13050	S/M/EM/PN/CES	2532
4772049003675	LO-EN9/1L/9900	95	125	11875	S/M/EM/PN/CES	2532
4772049003699	LO-EN9/1L/9900/4400	130	145	18850	S/M/EM/PN/CES	2532
4772049003705	LO-EN9/1L/9900/4400	135	125	16875	S/M/EM/PN/CES	2532
4772049003729	LO-EN10/1L/10000	100	145	14500	S/M/EM/PN/CES	2812
4772049003736	LO-EN10/1L/10000	105	125	13125	S/M/EM/PN/CES	2812
4772049003750	LO-EN10/1L/10000/5500	150	145	21750	S/M/EM/PN/CES	2812
4772049003767	LO-EN10/1L/10000/5500	155	125	19375	S/M/EM/PN/CES	2812
4772049003781	LO-EN2/1L/2200/TW	20	138	2760	S/M/EM/PN/CES	568
4772049003798	LO-EN2/1L/2200/1100/TW	30	143	4290	S/M/EM/PN/CES	568
4772049003804	LO-EN3/1L/3300/TW	30	143	4290	S/M/EM/PN/CES	849
4772049003811	LO-EN3/1L/3300/1100/TW	40	148	5920	S/M/EM/PN/CES	849
4772049003828	LO-EN4/1L/4400/TW	40	148	5920	S/M/EM/PN/CES	1129
4772049003835	LO-EN4/1L/4400/2200/TW	60	145	8700	S/M/EM/PN/CES	1129
4772049003842	LO-EN5/1L/5500/TW	50	144	7200	S/M/EM/PN/CES	1410
4772049003859	LO-EN5/1L/5500/2200/TW	70	146	10220	S/M/EM/PN/CES	1410



Ecolight™
Save simple.

ELEKTROS TAUPYMO SPRENDIMAI, UAB
 Moletu str. 13, Didzioji Riese (PC "Link Moletu"), Vilnius distr. 14028, Lithuania
 Liepu str. 15, Linksmakalinis, Kaunas distr. 53290, Lithuania
 E: info@ecolight.lt T: +370 5 2328207 F: +370 5 2784262
 W: www.ecolight.lt, www.ecolight-lights.co.uk

EAN	Additional options	Ref.
4772049001794	Microwave (-20 - +40 °C)	M
4772049002722	EasyAir SNS200/w	S
4772049001008	Emergency Pack 3h (1h optional)	EM
4772049003774	Custom colour painting	PN
4772049004641	Recessed version upgrade for LINAS OFFICE	R
4772049004658	Cyan Enhanced Static technology upgrade	CES

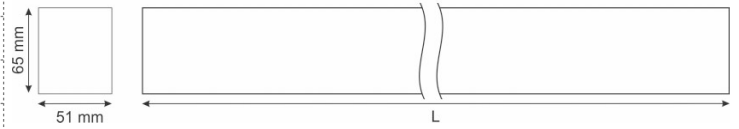

* There is a possibility to order ready-to-use luminaires with desired length of cable installed.

ACCESSORIES

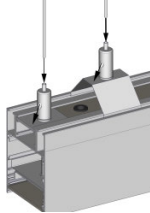
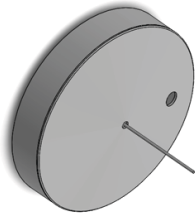
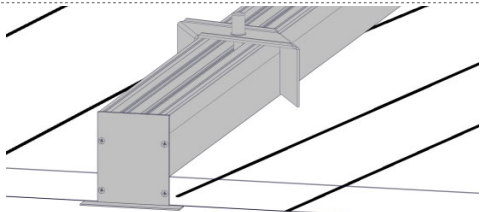
EAN	Description	Picture
4772049002807	SINGLE POINT LINAS OFFICE 1,5M SUSPENSION	
4772049004672	CEILING MOUNTED JUNCTION BOX	
4772049004610	ACCESSORY SET FOR LINAS OFFICE RECESSED MOUNTING	

EMERGENCY PACKS

TrustSight PRO 45-300V NiMH	3 hour
Operating Temperature	0 - +40 °C





LED Luminaires
and Retrofit Bulbs
Licensing Program

Member
ECOLIGHT.
Save simple



ISO 9001 - ISO 14001
OHSAS 18001

BUREAU VERITAS
Certification



LINAS INDUSTRY LED LI

THE ENERGY-EFFICIENT HIGH BAY LED LUMINAIRE LINAS INDUSTRY

Models: LI-EN4/3L/4400, LI-EN4/3L/8000,
LI-EN5/3L/5500, LI-EN5/3L/10000

LINEAR LIGHTING SOLUTION FOR WAREHOUSES

The multi-action linear LINAS INDUSTRY replaces standard fluorescent tubes and is suitable for installing both internally in warehouses and externally, too. Housed inside a sleek, IP65 protected body with a high density silicon rubber seal, the LINAS INDUSTRY incorporates 5 Way Protection from the elements; water, dust, ice, heat and corrosion. Providing a superb 145 lm/W efficacy, the LINAS INDUSTRY features a 60°, 90° or 85+40° beam for optimal light spread onto warehouse floors, aisles and shelving. The LINAS INDUSTRY can be suspended or surface mounted. Emergency backup and dimmable options available.

Good to know: LINAS INDUSTRY might be connected one into another without any cables.

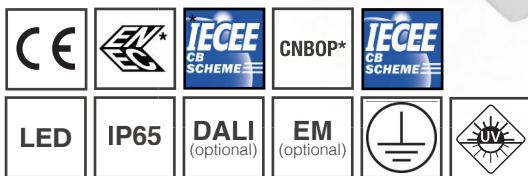
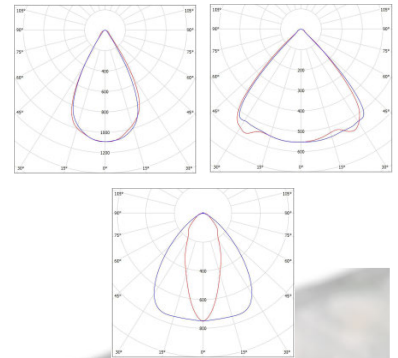
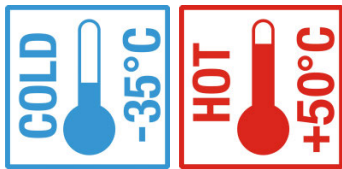

GENERAL TECHNICAL SPECIFICATIONS			
Supply Voltage	220-240V AC	Number of LED modules	4 or 5
Supply Frequency	50-60 Hz	Lamp Family Code	Philips Fortimo or Tridonic LLE
RFI Suppression	EN 55015 / CISPR 15	Light colour K	3000, 4000 or 5000
Immunity	EN 61547	Colour Rendering Index	> 80
Harmonics	EN 6100-3-2	Useful life L80B50 at Ta 50 °C	100.000 h
Operating Temperature	-35 - +50 °C	Driver /power unit/	Philips Xitanium or Tridonic LC
Storage Temperature	-40 - +60 °C	Flickering	IEEE 1789
Housing Material	Anodised aluminum	Power Factor (full load at 230V)	> 0.90
Diffuser	Ledil PMMA optics	Driver efficiency	> 90%
Cable gland	PG 13.5 or STUCCHI fast plug (optional)	Dimmable	Optional
Water and Dust Resistance	IP65	Emergency Pack	Optional
Impact Resistance	IK08	System Wattage	up to 105 W
Protection class IEC	Safety class I	System efficacy at max luminous flux	up to 152 lm/W
		System luminous flux (max)	up to 15.296 lm

* in preparation

** Only with Xtr drivers. Otherwise from -20 to +40 °C. Operating Temperature limitations for EM/P/S options see in next page.

GENERAL TECHNICAL SPECIFICATIONS

EAN	Ref.	Wattage	System efficacy at max luminous flux	System luminous flux (max)	Available Options	Length (mm)*	Optimum Working Height
4772049002548	LI-EN4/3L/4400	up to 63W	152 lm/W	9.580 lm	EM/P/S	1290	3 - 7 m
4772049002562	LI-EN4/3L/8000	up to 86W	154 lm/W	13.240 lm	EM/P/S		
4772049002586	LI-EN5/3L/5500	up to 78W	153 lm/W	11.930 lm	EM/P/S	1610	3 - 8 m
4772049002609	LI-EN5/3L/10000	up to 105W	155 lm/W	16.275 lm	EM/P/S		

* without sensor.

EAN	Additional options	Ref.
Multiple selection	PIR Sensor (-10/-30 - +35 °C)	P
Multiple selection	PIR and Light Sensor (-10/-30 - +35 °C)	S
4772049001008	Emergency Pack 3h (1h optional)	EM



* There is a possibility to order ready-to-use luminaries with desired length of cable installed.

EMERGENCY PACKS

TrustSight PRO 45-300V NiMH	3 hour
Operating Temperature	0 - +40 °C



LED Luminaires and Retrofit Bulbs Licensing Program

Member
ECOLIGHT.
Save simple

**ISO 9001 - ISO 14001
OHSAS 18001**

**BUREAU VERITAS
Certification**



Ecolight™
Save simple.

ELEKTROS TAUPYMO SPRENDIMAI, UAB
 Moletu str. 13, Didzioji Riese (PC "Link Moletu"), Vilnius distr. 14028, Lithuania
 Liepu str. 15, Linksmakalnis, Kaunas distr. 53290, Lithuania
 E: info@ecolight.lt T: +370 5 2328207 F: +370 5 2784262
 W: www.ecolight.lt, www.ecolight-lights.co.uk

LINAS INDUSTRY LED LI HORTI

HORTICULTURAL LIGHTING LED LUMINAIRE LINAS INDUSTRY

Models: LI-EN4/3L/4400/SU, LI-EN4/3L/4400/SO,
LI-EN5/3L/5500/SU, EN5/3L/5500/SO

HORTICULTURAL LIGHTING SOLUTION FOR GREENHOUSES

Horticulture lighting is used to support, increase and enable the growth of plants by illuminating them with artificial light. LED light is a very efficient way and upcoming solution for this application. The multi-action linear LINAS INDUSTRY HORTI equipped with OSRAM OSOLON SSL and SQUARE LEDs from OSRAM Opto Semiconductors developed specially for horticultural lighting. OSRAM Horticulture Tool may help you to choose the most optimal luminaire model and arrangement.

Good to know: LINAS INDUSTRY HORTI is suitable for top/inter lighting as well for vertical farming.

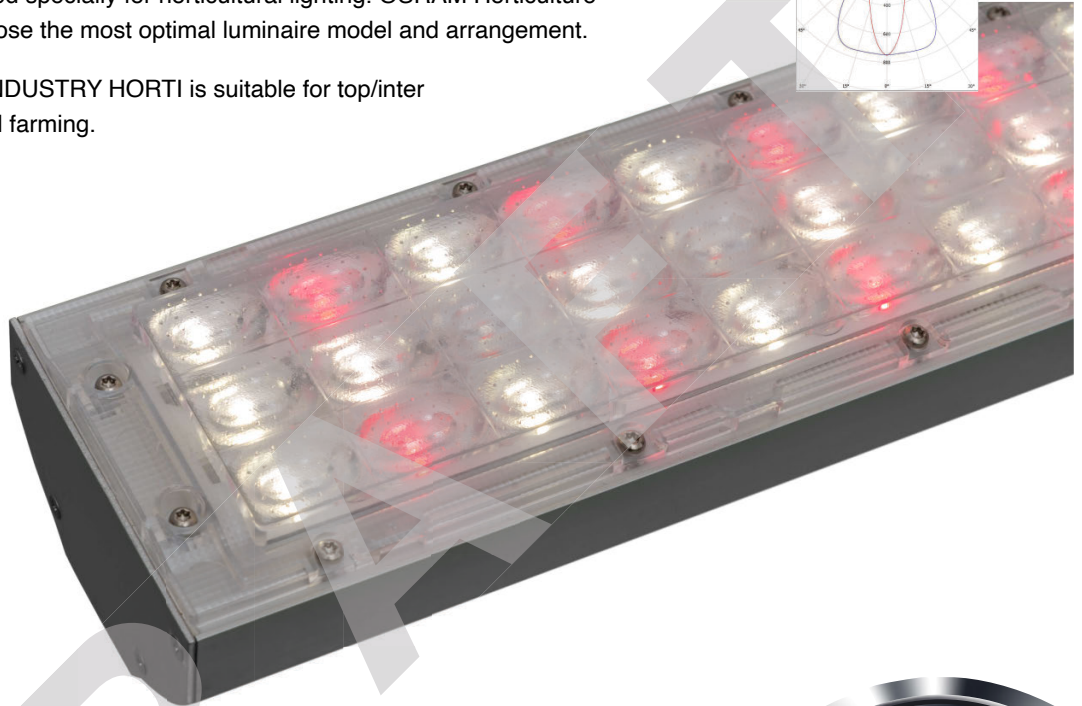
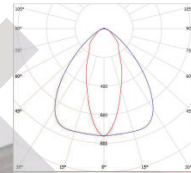
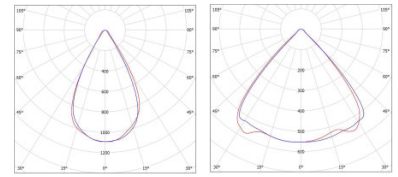

GENERAL TECHNICAL SPECIFICATIONS	
Supply Voltage	220-240V AC
Supply Frequency	50-60 Hz
RFI Suppression	EN 55015 / CISPR 15
Immunity	EN 61547
Harmonics	EN 6100-3-2
Operating Temperature	-25 - +45 °C
Storage Temperature	-40 - +60 °C
Housing Material	Anodised aluminum
Diffuser	Ledil PMMA optics
Cable gland	PG 13.5 or STUCCHI fast plug (optional)
Water and Dust Resistance	IP65 or IP67 (optional)
Impact Resistance	IK08
Protection class IEC	Safety class I

Number of LED modules	4 or 5
Lamp Family Code	OSRAM Opto Semiconductors
Min Useful Life L80B50	50.000 h
Driver /power unit/	Philips Xitanium or Tridonic LC
Power Factor (full load at 230V)	> 0.90
Driver efficiency	> 90%
Dimmable	Optional
System Wattage	up to 166 W
Wavelength spectrum	450 - 730 nm
Photon flux PPF (PAR)	up to 367 μmol/s
Efficacy	up to 2,6 μmol/s/watt

* in preparation

GENERAL TECHNICAL SPECIFICATIONS

EAN	Ref.	Light Recipy	Wattage	Efficacy μmol/s/watt	Photon flux PPF (PAR) μmol/s	Luminaire length (mm)
SUPPLEMENTAL LIGHTING						
	LI-EN4/3L/4400/SU/BIO	Plant growth	10% Deep Blue, 90% Hyper Red	111	2,6	1290
	LI-EN4/3L/4400/SU/PRO	Propagation	75% Deep Blue, 25% Hyper Red	133	2,2	
	LI-EN4/3L/4400/SU/FLO	Flowering	20% Deep Blue, 60% Hyper Red, 20% Far Red	111	2,1	
	LI-EN4/3L/4400/SU/FRU	Fruiting	20% White, 70% Hyper Red, 10% Far Red	112	2,3	
	LI-EN5/3L/5500/SU/BIO	Plant growth	10% Deep Blue, 90% Hyper Red	139	2,6	1610
	LI-EN5/3L/5500/SU/PRO	Propagation	75% Deep Blue, 25% Hyper Red	166	2,2	
	LI-EN5/3L/5500/SU/FLO	Flowering	20% Deep Blue, 60% Hyper Red, 20% Far Red	139	2,1	
	LI-EN5/3L/5500/SU/FRU	Fruiting	20% White, 70% Hyper Red, 10% Far Red	140	2,3	
SOLE SOURCE LIGHTING						
	LI-EN4/3L/4400/SO/BIO	Plant growth	80% White, 20% Hyper Red	131	1,9	1290
	LI-EN4/3L/4400/SO/PRO	Propagation	35% Deep Blue, 25% White, 25% Hyper Red, 15% Far Red	123	1,9	
	LI-EN4/3L/4400/SO/FLO	Flowering	60% White, 20% Hyper Red, 20% Far Red	121	1,7	
	LI-EN4/3L/4400/SO/FRU	Fruiting	60% White, 30% Hyper Red, 10% Far Red	122	1,9	
	LI-EN5/3L/5500/SO/BIO	Plant growth	80% White, 20% Hyper Red	164	1,9	1610
	LI-EN5/3L/5500/SO/PRO	Propagation	35% Deep Blue, 25% White, 25% Hyper Red, 15% Far Red	153	1,9	
	LI-EN5/3L/5500/SO/FLO	Flowering	60% White, 20% Hyper Red, 20% Far Red	151	1,7	
	LI-EN5/3L/5500/SO/FRU	Fruiting	60% White, 30% Hyper Red, 10% Far Red	153	1,9	



**ISO 9001 - ISO 14001
OHSAS 18001
BUREAU VERITAS
Certification**



ELEKTROS TAUPYMO SPRENDIMAI, UAB
 Moletu str. 13, Didžioji Riešė (PC "Link Moletu"), Vilnius distr. 14028, Lithuania
 Liepu str. 15, Linksmakalnis, Kaunas distr. 53290, Lithuania
 E: info@ecolight.lt T: +370 5 2328207 F: +370 5 2784262
 W: www.ecolight.lt, www.ecolight-lights.co.uk

THE ENERGY-EFFICIENT LOW BAY LED LUMINAIRE ELUMA

Models: ZL-EN2/1L/2200, ZL-EN2/1L/4000, ZL-EN4/1L/4400,
ZL-EN4/1L/8000, ZL-EN5/1L/5500, ZL-EN5/1L/10000

ELUMA LED ZL

AS POWERFUL AND EFFICIENT AS LOW BAYS CAN GET!

ELUMA LED ZL is an ultra-efficient low bay LED luminaire. Manufactured from EU-made parts, this extraordinary product sets an industry standard with a system power up to 75W. The system features outstanding thermal characteristics, and can be utilised in temperatures up to + 50°C. Different housing materials and diffuser options are available depending on application purposes. The combination of polycarbonate housing and frosted PC diffuser is ideal for parking lots and other public spaces (protection level IK08). The combination of GRP (glass fibre reinforced polyester) housing and PMMA (Acrylic) diffuser is ideal for industries dealing with chemical substances. ELUMA LED ZL is UV-resistant.

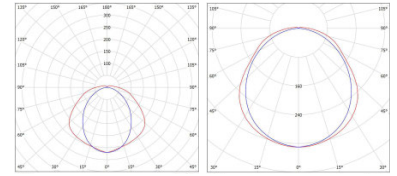

Good to know: If equipped with a SLIM diffuser, ELUMA LED ZL can be mounted as high as 8 meters off the ground.

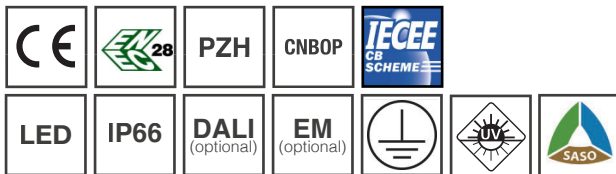
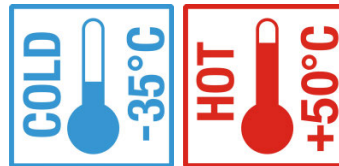
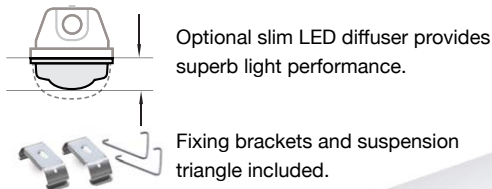

GENERAL TECHNICAL SPECIFICATIONS	
Supply Voltage	220-240V AC
Supply Frequency	50-60 Hz
RFI Suppression	EN 55015 / CISPR 15
Immunity	EN 61547
Harmonics	EN 6100-3-2
Operating Temperature	-35 - +50 °C
Storage Temperature	-40 - +60 °C
Housing Material	PC (Glass fibre reinforced polyester optional)
Diffuser	Frosted PC (frosted PMMA optional)
Gear Tray	Pre-painted steal 0.5 mm
Water and Dust Resistance	IP66
Impact Resistance	IK05 or IK08
Protection class IEC	Safety class I

Number of LED modules	up to 3
Lamp Family Code	Philips Fortimo
Light colour K	3000, 4000 or 5000
Colour Rendering Index	> 80 or > 90
Useful life L80B50 at Ta 50 °C	100.000 h
Driver /power unit/	Philips Xitanium
Flickering	IEEE 1789
Power Factor (full load at 230V)	> 0.90
Driver efficiency	> 90%
Dimmable	Optional
Emergency Pack	Optional
System Wattage	up to 75 W
System efficiency at max luminous flux	up to 160 lm/W
Sytem luminous flux (max)	up to 12.000 lm
Fire protection	Flammability (UL94): V2 Glow wire test (EN 60695-2-11): 850°

* Only with Xtr drivers. Otherwise from -20 to +40 °C. Operating Temperature limitations for EM/P/S options see in next page.

GENERAL TECHNICAL SPECIFICATIONS

EAN	Ref.	Wattage	System efficiency at max luminous flux	System luminous flux (max)	Available Options	Dimensions (mm)*		Optimum Working Height
						L	D	
4772049000452	ZL-EN2/1L/2200	up to 15W	170 lm/W	2.550 lm	M/P/S	660	390	up to 2 m
4772049000469	ZL-EN2/1L/4000	up to 25W	160 lm/W	4.000 lm	M/P/S			up to 3 m
4772049000476	ZL-EN4/1L/4400	up to 35W	170 lm/W	5.950 lm	EM/M/P/S	1277	800	up to 4 m
4772049000483	ZL-EN4/1L/8000	up to 65W	160 lm/W	10.400 lm	EM/M/P/S			up to 6 m
4772049000490	ZL-EN5/1L/5500	up to 45W	170 lm/W	7.650 lm	EM/M/P/S	1573	1100	up to 5 m
4772049000506	ZL-EN5/1L/10000	up to 65W	165 lm/W	10.725 lm	EM/M/P/S			up to 8 m
4772049000513	ZL-EN5/1L/10000	up to 75W	160 lm/W	12.000 lm	M/P/S			

* without sensor and standard diffuser

EAN	Additional options	Ref.
4772049001794	Microwave (-20 - +40 °C)	M
Multiple selection	PIR Sensor (-10/-30 - +35 °C)	P
Multiple selection	PIR and Light Sensor (-10/-30 - +35 °C)	S
4772049001008	Emergency Pack 3h (1h optional)*	EM

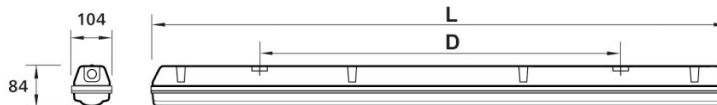

* Emergency pack not available for powers above 65W.

** There is a possibility to order ready-to-use luminaries with desired length of cable installed.

EMERGENCY PACKS

TrustSight PRO 45-300V NIMH	3 hour
Operating Temperature	0 - +40 °C



ISO 9001 - ISO 14001
OHSAS 18001

BUREAU VERITAS
Certification



EcolightTM
Save simple.

ELEKTROS TAUPYMO SPRENDIMAI, UAB
Moletu str. 13, Didžioji Riešė (PC "Link Moletu"), Vilnius distr. 14028, Lithuania
Liepu str. 15, Linksmakalnis, Kaunas distr. 53290, Lithuania
E: info@ecolight.lt T: +370 5 2328207 F: +370 5 2784262
W: www.ecolight.lt, www.ecolight-lights.co.uk

THE ENERGY-EFFICIENT LOW BAY LED LUMINAIRE ELUMA

Models: ZL-EN4/1L/4400, ZL-EN5/1L/5500

ELUMA LED ZL (Lite) GEN 2

HIGH QUALITY LOW COST SELECTION FOR LOW BAY LIGHTING!

ELUMA LED ZL Lite version is a high quality and low cost low bay LED luminaire. With CertaFlux and Xitanium components, ELUMA LED ZL Lite version is an optimised solution that works as a 1:1 replacement for your old, less efficient 2x36W and 2x58W fluorescent lighting systems. The system features high thermal characteristics, and can be utilised in temperatures up to + 35°C. Different housing materials and diffuser options are available depending on application purposes. The combination of polycarbonate housing and frosted PC diffuser is ideal for parking lots and other public spaces (protection level IK08). The combination of GRP (glass fibre reinforced polyester) housing and PMMA (Acrylic) diffuser is ideal for industries dealing with chemical substances. ELUMA LED ZL Lite is UV-resistant.

Good to know: If equipped with a SLIM diffuser, ELUMA LED ZL Lite can be mounted as high as 8 meters off the ground.

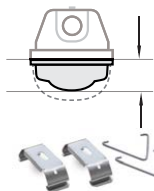
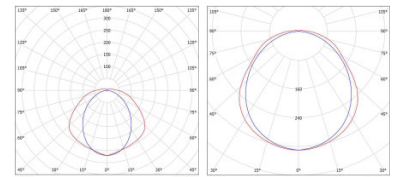

Optional slim LED diffuser provides superb light performance.

Fixing brackets and suspension triangle included.

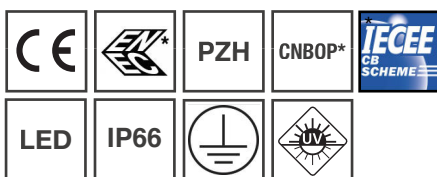

GENERAL TECHNICAL SPECIFICATIONS	
Supply Voltage	220-240V AC
Supply Frequency	50-60 Hz
RFI Suppression	EN 55015 / CISPR 15
Immunity	EN 61547
Harmonics	EN 6100-3-2
Operating Temperature	-35 - +35 °C
Storage Temperature	-40 - +60 °C
Housing Material	PC (Glass fibre reinforced polyester optional)
Diffuser	Frosted PC (frosted PMMA optional)
Gear Tray	Pre-painted steel 0.5 mm
Water and Dust Resistance	IP66
Impact Resistance	IK05 or IK08

Number of LED modules	1, 4 or 5
Lamp Family Code	CertaFlux
Light colour K	3000, 4000 or 6500
Colour Rendering Index	> 80
Useful life L80B50 at Ta 35 °C	62.000 h
Driver /power unit/	Philips Xitanium
Color consistency	3 SDCM
Power Factor (full load at 230V)	> 0.90
Driver efficiency	> 90%
Dimmable	Optional
Emergency Pack	Optional
System Wattage	up to 65 W
System efficiency at max luminous flux	up to 136 lm/W
Sytem luminous flux (max)	up to 8.840 lm
Fire protection	Flammability (UL94): V2 Glow wire test (EN 60695-2-11): 850°

* in preparation

GENERAL TECHNICAL SPECIFICATIONS

EAN	Ref.	Wattage	System efficiency at max luminous flux	System luminous flux (max)	Available Options	Dimensions (mm)*		Optimum Working Height
						L	D	
4772049001817	ZL-EN4/1L/4400	up to 50W	134 lm/W	6.700 lm	M/P/S/EM	1277	800	up to 4 m
4772049001824	ZL-EN5/1L/5500	up to 65W	136 lm/W	8.840 lm	M/P/S/EM	1573	1100	up to 5 m

* without standard diffuser

** There is a possibility to order ready-to-use luminaries with desired length of cable installed.

EAN	Additional options	Ref.
4772049001794	Microwave (-20 - +40 °C)	M
Multiple selection	PIR Sensor (-10/-30 - +35 °C)	P
Multiple selection	PIR and Light Sensor (-10/-30 - +35 °C)	S
4772049001008	Emergency Pack 3h (1h optional)	EM

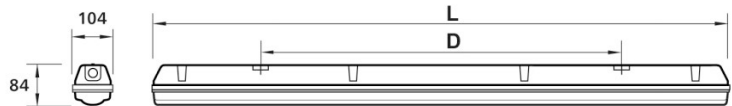

* There is a possibility to order ready-to-use luminaries with desired length of cable installed.

EMERGENCY PACKS

TrustSight PRO 45-300V NiMH	3 hour
Operating Temperature	0 - +40 °C



**ISO 9001 - ISO 14001
OHSAS 18001**

**BUREAU VERITAS
Certification**



Ecolight™
Save simple.

ELEKTROS TAUPYMO SPRENDIMAI, UAB
Moletu str. 13, Didzioji Riese (PC "Link Moletu"), Vilnius distr. 14028, Lithuania
Liepu str. 15, Linksmakainis, Kaunas distr. 53290, Lithuania
E: info@ecolight.lt T: +370 5 2328207 F: +370 5 2784262
W: www.ecolight.lt, www.ecolight-lights.co.uk

THE ENERGY-EFFICIENT LOW BAY LED LUMINAIRE ELUMA

Models: PD-EN4/1L/4400, PD-EN4/1L/8000,
PD-EN5/1L/5500, PD-EN5/1L/10000



FOR A SMOOTH AND EVEN LIGHT

Utilising cutting-edge LED technologies, ELUMA LED PD features authentic 'German' design and unique light characteristics. A special diffuser produces a pleasant effect of a smooth, even light. Different housing materials and diffuser options are available depending on application purposes. The combination of GRP (glass fibre reinforced polyester) housing and polycarbonate diffuser is ideal for parking lots and other public spaces (Protection level IK07). The combination of GRP housing and PMMA (Acrylic) diffuser is ideal for industries dealing with chemical substances. ELUMA LED PD is UV-resistant. The system features outstanding thermal characteristics, and can be utilised in temperatures up to + 50°C

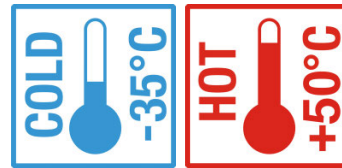
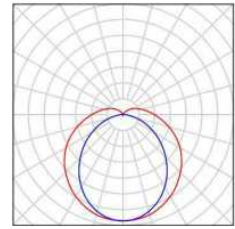

Good to know: The power of this system is limited to 65W.

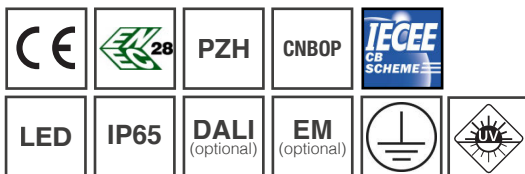

GENERAL TECHNICAL SPECIFICATIONS		
Supply Voltage	220-240V AC	Number of LED modules
Supply Frequency	50-60 Hz	Lamp Family Code
RFI Suppression	EN 55015 / CISPR 15	Light colour K
Immunity	EN 61547	Colour Rendering Index
Harmonics	EN 6100-3-2	Useful life L80B50 at Ta 50 °C
Operating Temperature*	-35 - +50 °C	Driver /power unit/
Storage Temperature	-40 - +60 °C	Driver efficiency
Housing Material	Glass fibre reinforced flame-resistant polyester	Flickering
Diffuser	PC (Polycarbonate)	Power Factor (full load at 230V)
Gear Tray	Pre-painted steal 0.5 mm	Dimmable
Water and Dust Resistance	IP65	Emergency Pack
Impact Resistance	IK05 or IK07	System Wattage
Protection class IEC	Safety class I	System efficiency at max luminous flux
		Sytem luminous flux (max)

* Only with Xtr drivers. Otherwise from -20 to +40 °C. Operating Temperature limitations for EM/P/S options see in next page.

GENERAL TECHNICAL SPECIFICATIONS

EAN	Ref.	Wattage	System efficiency at max luminous flux	System luminous flux (max)	Available Options	Dimensions (mm)*		Optimum Working Height
						L	D	
4772049000520	PD-EN4/1L/4400	up to 35W	170 lm/W	5.950 lm	EM/M/P/S	1210	880	up to 4 m
4772049000537	PD-EN4/1L/8000	up to 65W	160 lm/W	10.400 lm	EM/M/P/S			up to 6 m
4772049000544	PD-EN5/1L/5500	up to 45W	170 lm/W	7.650 lm	EM/M/P/S	1510	1180	up to 4 m
4772049000551	PD-EN5/1L/10000	up to 65W	165 lm/W	10.725 lm	EM/M/P/S			up to 6 m

* without sensor

EAN	Additional options	Ref.
4772049001794	Microwave (-20 - +40 °C)	M
Multiple selection	PIR Sensor (-10/-30 - +35 °C)	P
Multiple selection	PIR and Light Sensor (-10/-30 - +35 °C)	S
4772049001008	Emergency Pack 3h (1h optional)	EM

* There is a possibility to order ready-to-use luminaries with desired length of cable installed.

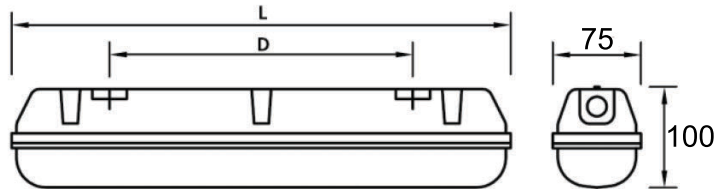

EMERGENCY PACKS

TrustSight PRO 45-300V NiMH	3 hour
Operating Temperature	0 - +40 °C



ISO 9001 - ISO 14001
OHSAS 18001

BUREAU VERITAS
Certification



ELEKTROS TAUPYMO SPRENDIMAI, UAB
Moletu str. 13, Didzioji Riese (PC "Link Moletu"), Vilnius distr. 14028, Lithuania
Liepu str. 15, Linksmakainis, Kaunas distr. 53290, Lithuania
E: info@ecolight.lt T: +370 5 2328207 F: +370 5 2784262
W: www.ecolight.lt, www.ecolight-lights.co.uk

THE ENERGY-EFFICIENT LOW BAY LED LUMINAIRE ELUMA

Models: LE-EN4/1L/4400, LE-EN4/1L/8000,
LE-EN5/1L/5500, LE-EN5/1L/10000



A PERFECT FIT FOR PARKING LOTS

The key feature of this standard-setting low bay luminaire is a pleasant and cosy light. This light effect is created by a special matte diffuser. ELUMA LED LE has an outstanding system power of 75W. The system features impressive thermal characteristics, and can be utilised in temperatures up to + 50°C. Polycarbonate housing, soft diffuser and PC cover make this system an optimal choice for the illumination of enclosed parking lots, garages, etc. (protection level IK08).

Good to know: ELUMA LED LE is not resistant to UV rays and, therefore, should not be employed in facilities with access to daylight.

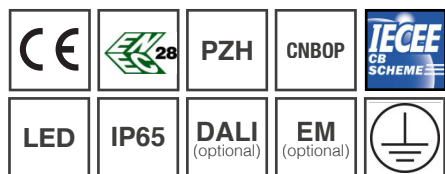
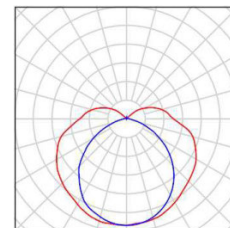
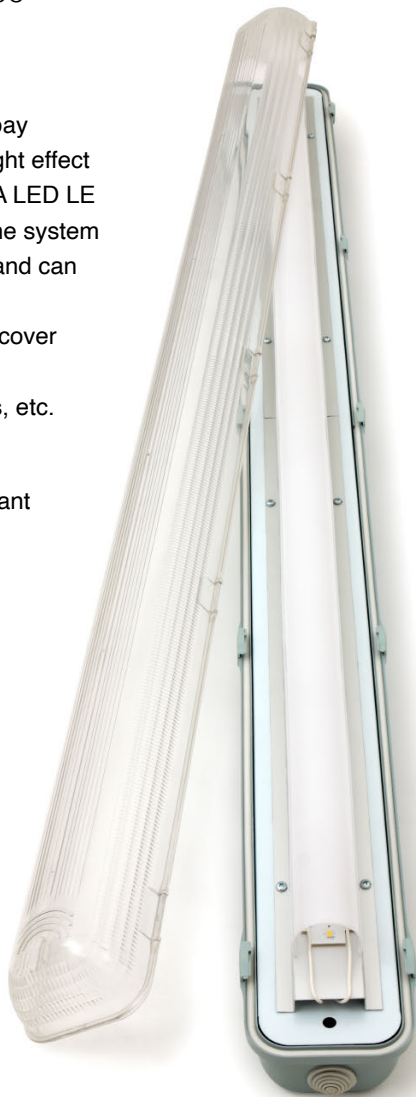
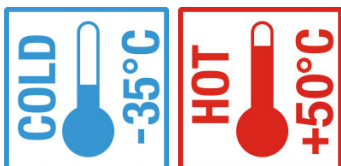

GENERAL TECHNICAL SPECIFICATIONS			
Supply Voltage	220-240V AC	Number of LED modules	1-3
Supply Frequency	50-60 Hz	Lamp Family Code	Philips Fortimo
RFI Suppression	EN 55015 / CISPR 15	Light colour K	3000, 4000 or 5000
Immunity	EN 61547	Colour Rendering Index	> 80 or > 90
Harmonics	EN 6100-3-2	Useful life L80B50 at Ta 50 °C	100.000 h
Operating Temperature*	-35 - +50 °C	Driver /power unit/	Philips Xitanium
Storage Temperature	-40 - +60 °C	Driver efficiency	> 90%
Housing Material	ABS	Flickering	IEEE 1789
Diffuser	PC or PS	Power Factor (full load at 230V)	> 0.90
Gear Tray	Pre-painted steal 0.5 mm	Dimmable	Optional
Water and Dust Resistance	IP65	Emergency Pack	Optional
Impact Resistance	IK08	System Wattage	up to 75 W
Protection class IEC	Safety class I	System efficiency at max luminous flux	up to 160 lm/W
		Sytem luminous flux (max)	up to 12.000 lm

* Only with Xtr drivers. Otherwise from -20 to +40 °C. Operating Temperature limitations for EM/P/S options see in next page.

GENERAL TECHNICAL SPECIFICATIONS

EAN	Ref.	Wattage	System efficiency at max luminous flux	System luminous flux (max)	Available Options	Dimensions (mm)*		Optimum Working Height
						L	D	
4772049000384	LE-EN2/1L/2200	up to 15W	170 lm/W	2.550 lm	M/P/S	670		up to 4 m
4772049000391	LE-EN2/1L/4000	up to 25W	160 lm/W	4.000 lm	M/P/S			
4772049000407	LE-EN4/1L/4400	up to 35W	170 lm/W	5.950 lm	EM/M/P/S	1270	835	up to 6 m
4772049000414	LE-EN4/1L/8000	up to 65W	160 lm/W	10.400 lm	EM/M/P/S			
4772049000421	LE-EN5/1L/5500	up to 45W	170 lm/W	7.650 lm	EM/M/P/S	1570	955	up to 6 m
4772049000438	LE-EN5/1L/10000	up to 65W	165 lm/W	10.725 lm	EM/M/P/S			
4772049000445	LE-EN5/1L/10000	up to 75W	160 lm/W	12.000 lm	EM/M/P/S			

* without sensor

EAN	Additional options	Ref.
4772049001794	Microwave (-20 - +40 °C)	M
Multiple selection	PIR Sensor (-10/-30 - +35 °C)	P
Multiple selection	PIR and Light Sensor (-10/-30 - +35 °C)	S
4772049001008	Emergency Pack 3h (1h optional)*	EM

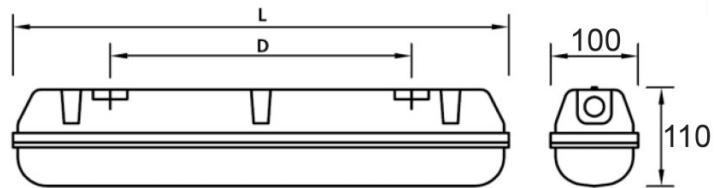

* Emergency pack not available for powers above 65W.

** There is a possibility to order ready-to-use luminaires with desired length of cable installed.

EMERGENCY PACKS

TrustSight PRO 45-300V NiMH	3 hour
Operating Temperature	0 - +40 °C



ISO 9001 - ISO 14001
OHSAS 18001

BUREAU VERITAS
Certification



ELEKTROS TAUPYMO SPRENDIMAI, UAB
 Moletu str. 13, Didžioji Riešė (PC "Link Moletu"), Vilnius distr. 14028, Lithuania
 Liepu str. 15, Linksmakalnis, Kaunas distr. 53290, Lithuania
 E: info@ecolight.lt T: +370 5 2328207 F: +370 5 2784262
 W: www.ecolight.lt, www.ecolight-lights.co.uk

THE ENERGY-EFFICIENT LED STREET LIGHT

Model: ST-1M/4000



ROAD LIGHTING AT ITS BEST

RADIUS LET ST street light showcases elegant compact design, and features state-of-the-art technologies from Philips. The system is equipped with Fortimo Fast Flex modules and Philips Xitanium Outdoor drivers. Fast Flex modules have a minimum lifetime of 120.000 hours. Other key features include a smart overheat prevention system, an efficient light angle control system, and a Dynadimmer function which allows energy-saving programmability. The system has great thermal characteristics, and can be utilised in temperatures ranging from - 40°C to + 50°C. To match the needs of different applications, RADIUS LED ST has six different optics options available.

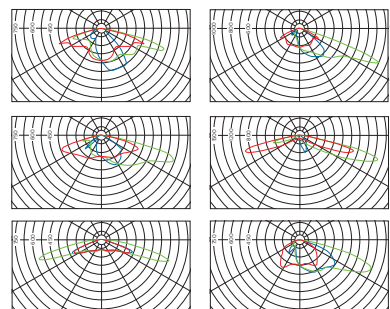

Good to know: The system can be mounted on horizontal and vertical poles.

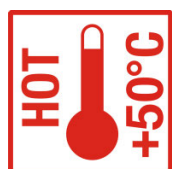

GENERAL TECHNICAL SPECIFICATIONS		Number of LED modules	1
Supply Voltage	220-240V AC	Lamp family code	Fortimo FastFlex
Supply Frequency	50-60 Hz	Light colour K	3000, 4000 or 5700
RFI Suppression	EN 55015 / CISPR 15	Colour Rendering Index	> 70 or > 80
Immunity	EN 61547	Useful life L90B50 at Ta 50 OC	100.000 h
Harmonics	EN 6100-3-2	Driver /power unit/	PHILIPS XITANIUM
Operating Temperature**	-40 - +50 °C	Flickering	IEEE 1789
Storage Temperature	-40 - +60 °C	Power factor (full load at 230V)	> 0.95
Housing material	Aluminum	Control method	1- 10V, Dynadimmer LITE (DALI optional)
Enclosure Rating	IP66	Dimming range	7 ...100 %
Lid material	Tempered Glass	System Wattage	up to 40 W
Mech. impact protection	IK09	System efficiency at max luminous flux	up to 141 lm/W
Protection class IEC	Safety class I	System luminous flux (max)	up to 5.640 lm

* in preparation

GENERAL TECHNICAL SPECIFICATIONS

EAN	Ref.	Wattage	LED module efficiency at luminous flux	System luminous flux (max)	Dimensions (mm)				Area (mm ²)	
					D	L	W	H	S ₁	S ₂
4772049004689	ST-1M/4000	20W	153 lm/W	3.060 lm	410	490	205	165	0,0218	0,0256
		30W	147 lm/W	4.410 lm						
		40W	141 lm/W	5.640 lm						

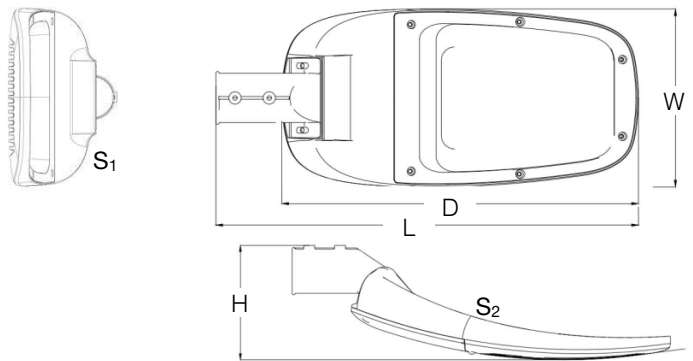
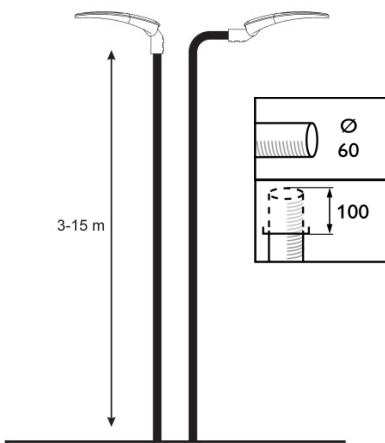

AVAILABLE OPTICS

FastFlex lens 2x8/II-X Gen2

Designed for narrow roads and urban street lighting.

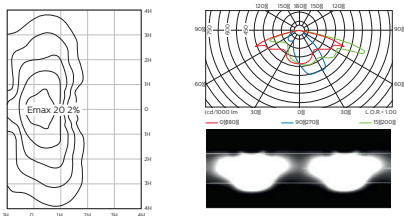

FastFlex lens 2x8/IV-X Gen2

Designed for wide roads and asymmetrical floodlighting.

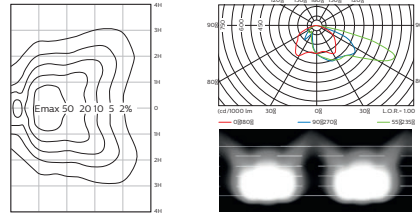

FastFlex lens 2x8/II-X WTR Gen2

Designed for wet road lighting.

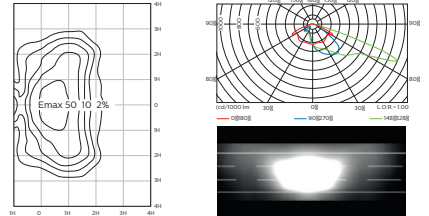

FastFlex lens 2x8/III-X Gen2

Designed for roads of medium width and urban street lighting.

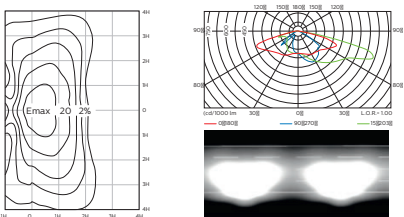

FastFlex lens 2x8/V Gen2

Designed for symmetrical lighting, e.g. parking lots, petrol stations.

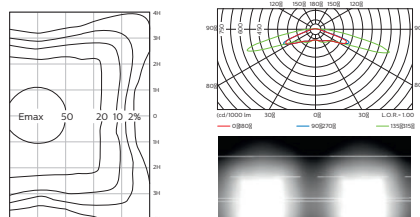

FastFlex lens 2x4/SW-X Gen2

Designed for Pedestrian Road and Bicycle lighting.

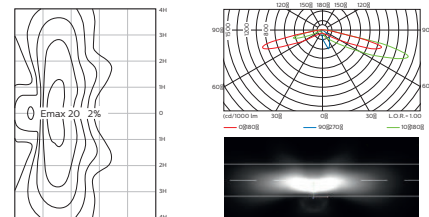

LED Luminaires and Retrofit Bulbs Licensing Program

Member **ECOLIGHT**. Save simple

ENABLED

**ISO 9001 - ISO 14001
OHSAS 18001**

**BUREAU VERITAS
Certification**

Ecolight™ ELEKTROS TAUPYMO SPRENDIMAI, UAB
 Didlaukio str. 94-22, Vilnius 08332, Lithuania
 Liepu str. 15, Linksmakalnis, Kaunas distr. 53290, Lithuania
 E: info@ecolight.lt T: +370 5 2328207 F: +370 5 2784262
 W: www.ecolight.lt, www.ecolight-lights.co.uk

THE ENERGY-EFFICIENT LED STREET LIGHT

Model: ST-1M/6000



ROAD LIGHTING AT ITS BEST

RADIUS LET ST street light showcases elegant compact design, and features state-of-the-art technologies from Philips. The system is equipped with Fortimo Fast Flex modules and Philips Xitanium Outdoor drivers. Fast Flex modules have a minimum lifetime of 120.000 hours. Other key features include a smart overheat prevention system, an efficient light angle control system, and a Dynadimmer function which allows energy-saving programmability. The system has great thermal characteristics, and can be utilised in temperatures ranging from - 40°C to + 50°C. To match the needs of different applications, RADIUS LED ST has six different optics options available.

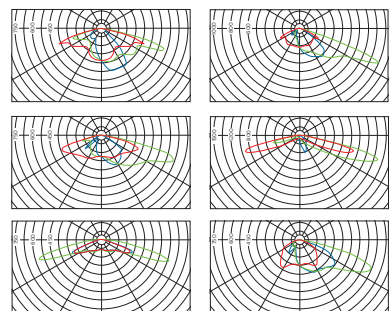

Good to know: The system can be mounted on horizontal and vertical poles.

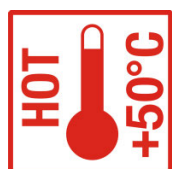

GENERAL TECHNICAL SPECIFICATIONS		Number of LED modules	1
Supply Voltage	220-240V AC	Lamp family code	Fortimo FastFlex
Supply Frequency	50-60 Hz	Light colour K	3000, 4000 or 5700
RFI Suppression	EN 55015 / CISPR 15	Colour Rendering Index	> 70 or > 80
Immunity	EN 61547	Min useful life	See next page
Harmonics	EN 6100-3-2	Driver /power unit/	PHILIPS XITANIUM
Operating Temperature**	-40 - +50 °C	Flickering	IEEE 1789
Storage Temperature	-40 - +60 °C	Power factor (full load at 230V)	> 0.95
Housing material	Aluminum	Control method	1- 10V, Dynadimmer LITE (DALI optional)
Enclosure Rating	IP66	Dimming range	7 ...100 %
Lid material	Tempered Glass	System Wattage	up to 50 W
Mech. impact protection	IK09	System efficiency at max luminous flux	up to 147 lm/W
Protection class IEC	Safety class I	Sytem luminous flux (max)	up to 7.350 lm

* in preparation

GENERAL TECHNICAL SPECIFICATIONS

EAN	Ref.	Wattage	LED module efficiency (max)	Lumen output of LED modules (max)	Dimensions (mm)				Area (mm ²)	
					D	L	W	H	S ₁	S ₂
4772049004696	ST-1M/6000	20W	160 lm/W	3.200 lm	520	616	259	186	0,0306	0,0373
		30W	157 lm/W	4.710 lm						
		40W	152 lm/W	6.080 lm						
		50W	147 lm/W	7.350 lm						

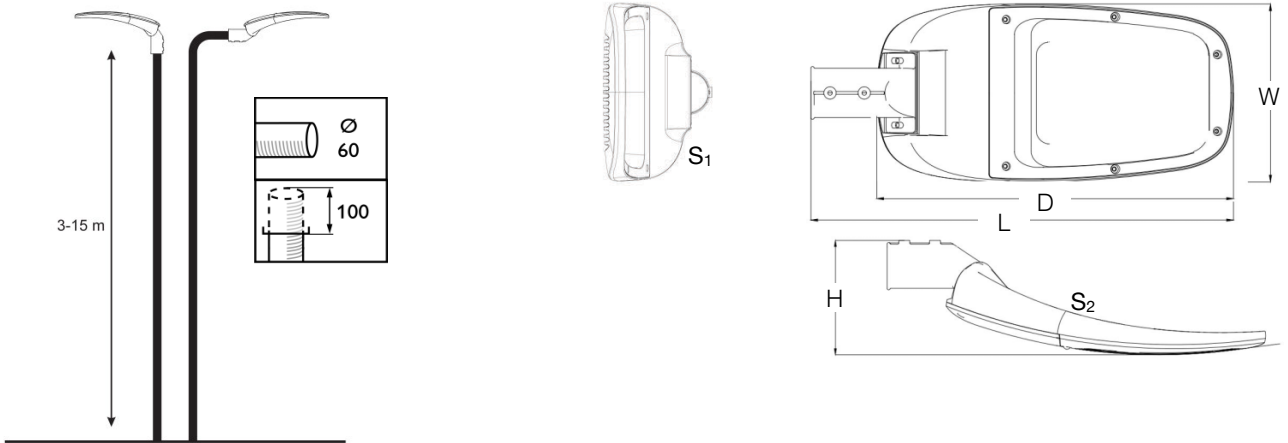

AVAILABLE OPTICS

FastFlex lens 2x8/II-X Gen2

Designed for narrow roads and urban street lighting.

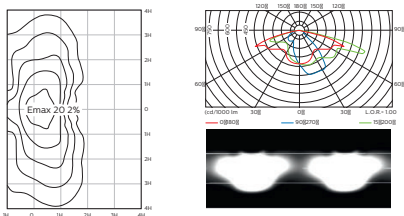

FastFlex lens 2x8/IV-X Gen2

Designed for wide roads and asymmetrical floodlighting.

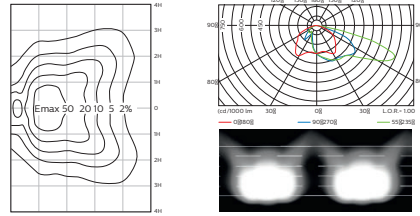

FastFlex lens 2x8/II-X WTR Gen2

Designed for wet road lighting.

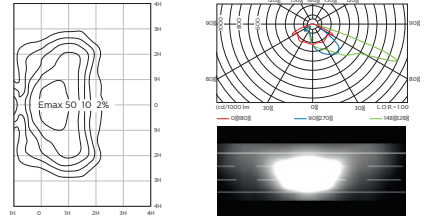

FastFlex lens 2x8/III-X Gen2

Designed for roads of medium width and urban street lighting.

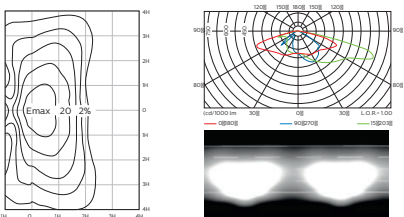

FastFlex lens 2x8/V Gen2

Designed for symmetrical lighting, e.g. parking lots, petrol stations.

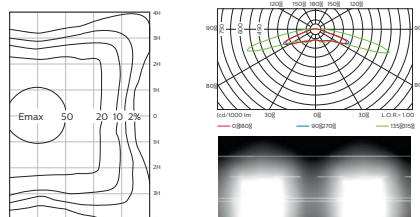

FastFlex lens 2x4/SW-X Gen2

Designed for Pedestrian Road and Bicycle lighting.

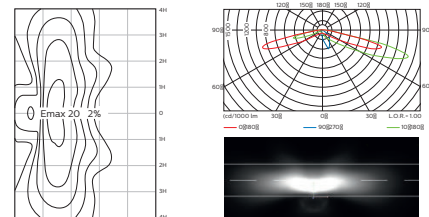

ISO 9001 - ISO 14001
OHSAS 18001

BUREAU VERITAS
Certification

ELEKTROS TAUPYMO SPRENDIMAI, UAB
Didlaukio str. 94-22, Vilnius 08332, Lithuania
Liepu str. 15, Linksmakalnis, Kaunas distr. 53290, Lithuania
E: info@ecolight.lt T: +370 5 2328207 F: +370 5 2784262
W: www.ecolight.lt, www.ecolight-lights.co.uk

THE ENERGY-EFFICIENT LED STREET LIGHT

Model: ST-2M/6000



ROAD LIGHTING AT ITS BEST

RADIUS LET ST street light showcases elegant compact design, and features state-of-the-art technologies from Philips. The system is equipped with Fortimo Fast Flex modules and Philips Xitanium Outdoor drivers. Fast Flex modules have a minimum lifetime of 120.000 hours. Other key features include a smart overheat prevention system, an efficient light angle control system, and a Dynadimmer function which allows energy-saving programmability. The system has great thermal characteristics, and can be utilised in temperatures ranging from - 40°C to + 50°C. To match the needs of different applications, RADIUS LED ST has six different optics options available.

Good to know: The system can be mounted on horizontal and vertical poles.

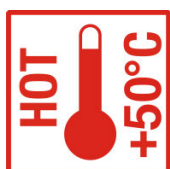
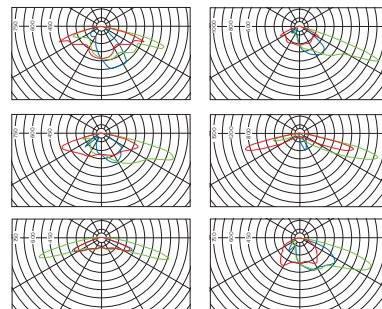

GENERAL TECHNICAL SPECIFICATIONS		Number of LED modules	2
Supply Voltage	220-240V AC	Lamp family code	Fortimo FastFlex
Supply Frequency	50-60 Hz	Light colour K	3000, 4000 or 5700
RFI Suppression	EN 55015 / CISPR 15	Colour Rendering Index	> 70 or > 80
Immunity	EN 61547	Useful life L90B50 at Ta 50 °C	100.000 h
Harmonics	EN 6100-3-2	Driver /power unit/	PHILIPS XITANIUM
Operating Temperature**	-40 - +50 °C	Flickering	IEEE 1789
Storage Temperature	-40 - +60 °C	Power factor (full load at 230V)	> 0.95
Housing material	Aluminum	Control method	1- 10V, Dynadimmer LITE (DALI optional)
Enclosure Rating	IP66	Dimming range	7 ...100 %
Lid material	Tempered Glass	System Wattage	up to 100 W
Mech. impact protection	IK09	System efficiency at max luminous flux	up to 149 lm/W
Protection class IEC	Safety class I	Sytem luminous flux (max)	up to 14.900 lm

* in preparation

GENERAL TECHNICAL SPECIFICATIONS

EAN	Ref.	Wattage	LED module efficiency (max)	Lumen output of LED modules (max)	Dimensions (mm)				Area (mm ²)	
					D	L	W	H	S ₁	S ₂
4772049004702	ST-2M/6000	40W	162 lm/W	6.480 lm	580	676	303	186	0,0415	0,0394
		60W	159 lm/W	9.540 lm						
		80W	154 lm/W	12.320 lm						
		100W	149 lm/W	14.900 lm						

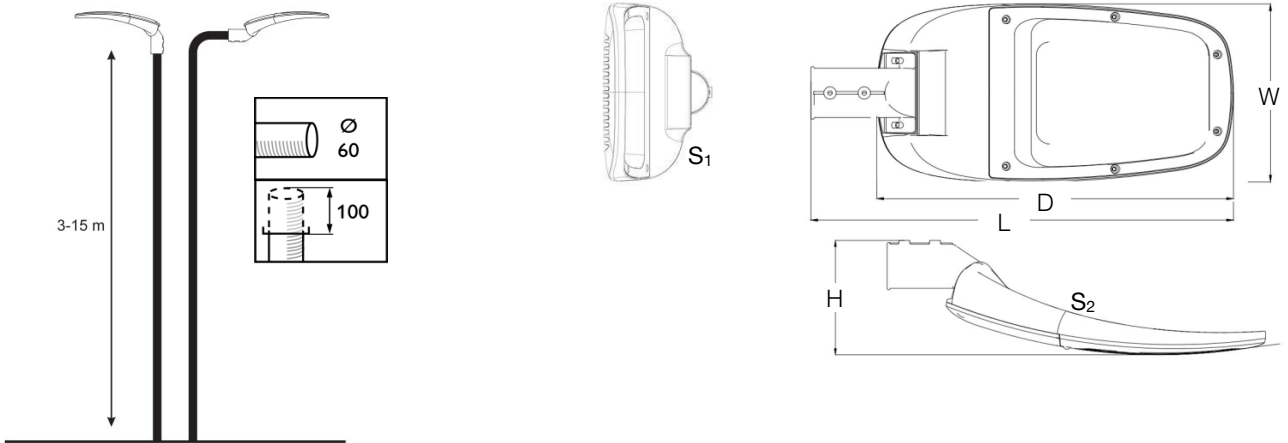

AVAILABLE OPTICS

FastFlex lens 2x8/II-X Gen2

Designed for narrow roads and urban street lighting.

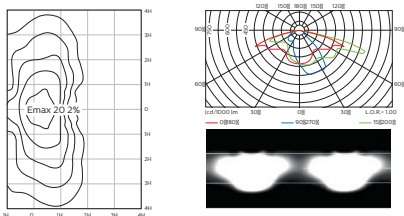

FastFlex lens 2x8/IV-X Gen2

Designed for wide roads and asymmetrical floodlighting.

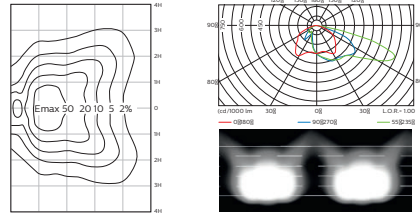

FastFlex lens 2x8/II-X WTR Gen2

Designed for wet road lighting.

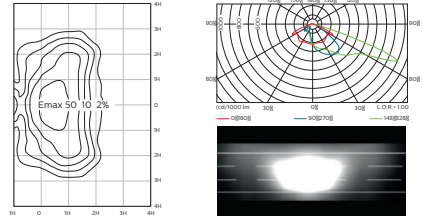

FastFlex lens 2x8/III-X Gen2

Designed for roads of medium width and urban street lighting.

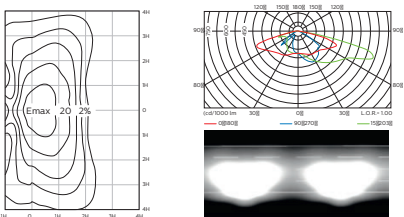

FastFlex lens 2x8/V Gen2

Designed for symmetrical lighting, e.g. parking lots, petrol stations.

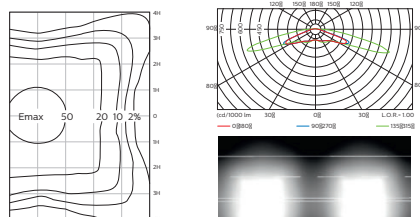

FastFlex lens 2x4/SW-X Gen2

Designed for Pedestrian Road and Bicycle lighting.

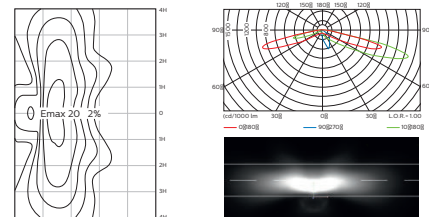

LED Luminaires and Retrofit Bulbs Licensing Program

Member **ECOLIGHT.**
Save simple

ENABLED

**ISO 9001 - ISO 14001
OHSAS 18001**

**BUREAU VERITAS
Certification**

Ecolight™ ELEKTROS TAUPYMO SPRENDIMAI, UAB
Didlaukio str. 94-22, Vilnius 08332, Lithuania
Liepu str. 15, Linksmakalnis, Kaunas distr. 53290, Lithuania
E: info@ecolight.lt T: +370 5 2328207 F: +370 5 2784262
W: www.ecolight.lt, www.ecolight-lights.co.uk

Save simple.

THE ENERGY-EFFICIENT LED STREET LIGHT

Model: ST-3M/6000



ROAD LIGHTING AT ITS BEST

RADIUS LET ST street light showcases elegant compact design, and features state-of-the-art technologies from Philips. The system is equipped with Fortimo Fast Flex modules and Philips Xitanium Outdoor drivers. Fast Flex modules have a minimum lifetime of 120.000 hours. Other key features include a smart overheat prevention system, an efficient light angle control system, and a Dynadimmer function which allows energy-saving programmability. The system has great thermal characteristics, and can be utilised in temperatures ranging from - 40°C to + 50°C. To match the needs of different applications, RADIUS LED ST has six different optics options available.

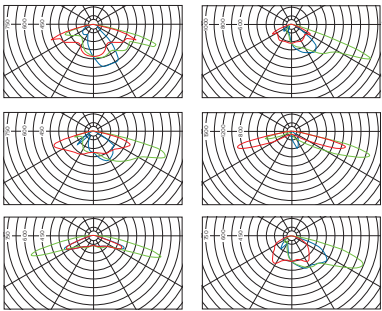

Good to know: The system can be mounted on horizontal and vertical poles.



GENERAL TECHNICAL SPECIFICATIONS	
Supply Voltage	220-240V AC
Supply Frequency	50-60 Hz
RFI Suppression	EN 55015 / CISPR 15
Immunity	EN 61547
Harmonics	EN 6100-3-2
Operating Temperature**	-40 - +50 °C
Storage Temperature	-40 - +60 °C
Housing material	Aluminum
Enclosure Rating	IP66
Lid material	Tempered Glass
Mech. impact protection	IK09
Protection class IEC	Safety class I

Number of LED modules	3
Lamp family code	Fortimo FastFlex
Light colour K	3000, 4000 or 5700
Colour Rendering Index	> 70 or > 80
Useful life L90B50 at Ta 50 °C	100.000 h
Driver /power unit/	PHILIPS XITANIUM
Flickering	IEEE 1789
Power factor (full load at 230V)	> 0.95
Control method	1- 10V, Dynadimmer LITE (DALI optional)
Dimming range	7 ... 100 %
System Wattage	up to 150 W
System efficiency at max luminous flux	up to 149 lm/W
Sytem luminous flux (max)	up to 22.350 lm

* in preparation

GENERAL TECHNICAL SPECIFICATIONS

EAN	Ref.	Wattage	LED module efficiency (max)	Lumen output of LED modules (max)	Dimensions (mm)				Area (mm ²)	
					D	L	W	H	S ₁	S ₂
4772049004719	ST-3M/6000	60W	162 lm/W	9.720 lm	580	676	303	186	0,0415	0,0394
		90W	159 lm/W	14.310 lm						
		120W	154 lm/W	18.480 lm						
		150W	149 lm/W	22.350 lm						

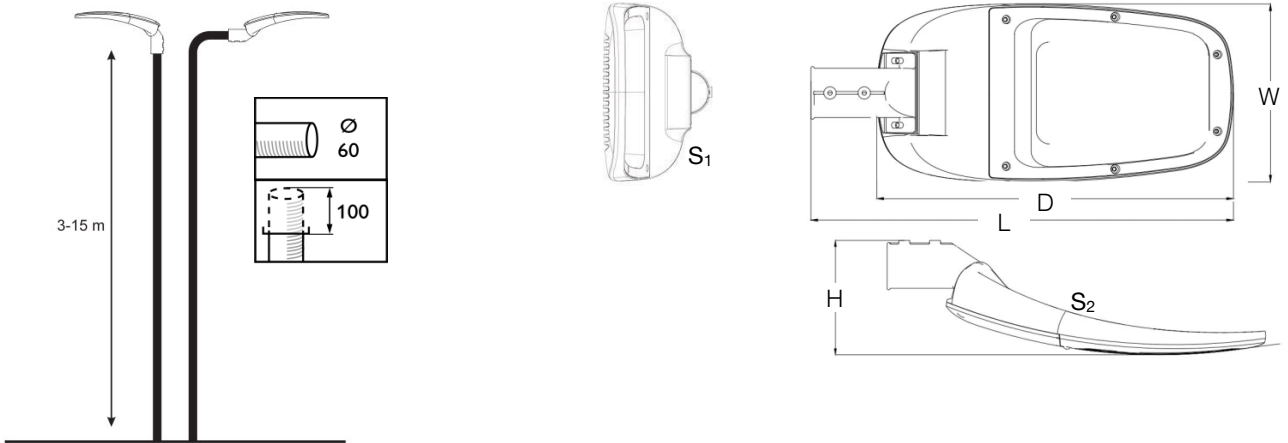

AVAILABLE OPTICS

FastFlex lens 2x8/II-X Gen2

Designed for narrow roads and urban street lighting.

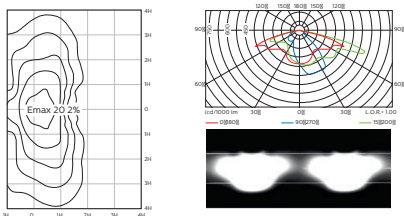

FastFlex lens 2x8/IV-X Gen2

Designed for wide roads and asymmetrical floodlighting.

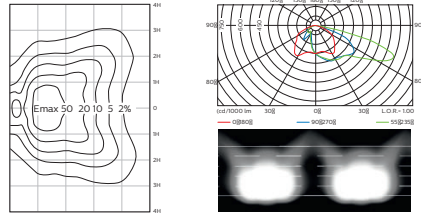

FastFlex lens 2x8/II-X WTR Gen2

Designed for wet road lighting.

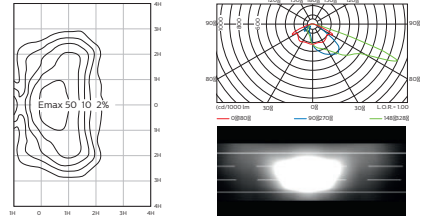

FastFlex lens 2x8/III-X Gen2

Designed for roads of medium width and urban street lighting.

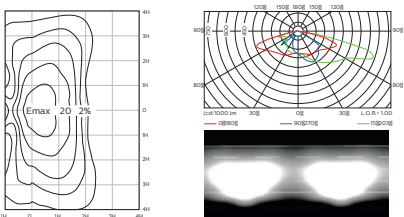

FastFlex lens 2x8/V Gen2

Designed for symmetrical lighting, e.g. parking lots, petrol stations.

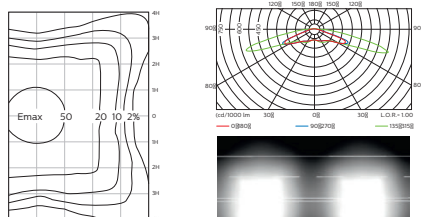

FastFlex lens 2x4/SW-X Gen2

Designed for Pedestrian Road and Bicycle lighting.

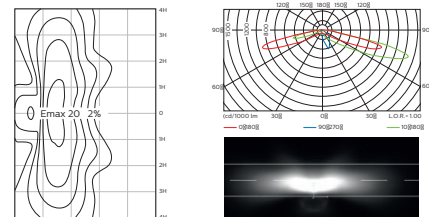

LED Luminaires and Retrofit Bulbs Licensing Program

Member **ECOLIGHT.**
Save simple

ENABLED

**ISO 9001 - ISO 14001
OHSAS 18001**

**BUREAU VERITAS
Certification**



Ecolight™
Save simple.

ELEKTROS TAUPYMO SPRENDIMAI, UAB
Didlaukio str. 94-22, Vilnius 08332, Lithuania
Liepu str. 15, Linksmakalnis, Kaunas distr. 53290, Lithuania
E: info@ecolight.lt T: +370 5 2328207 F: +370 5 2784262
W: www.ecolight.lt, www.ecolight-lights.co.uk

THE ENERGY-EFFICIENT LED STREET LIGHT

Model: ST-1M/6000/G2

RADIUS LED ST GEN2

ROAD LIGHTING AT ITS BEST

RADIUS LET ST street light showcases elegant compact design, and features state-of-the-art technologies from Philips. The system is equipped with Philips FastFlex modules and Philips Xitanium Outdoor drivers. FastFlex modules have a minimum lifetime of 120.000 hours. Other key features include a smart overhear prevention system, an efficient light angle control system, and a Dynadimmer function which allows energy-saving programmability. The system has great thermal characteristics, and can be utilised in temperatures ranging from – 40°C to + 50°C. To match the needs of different applications, RADIUS LED ST has six standard and many optics options from LEDiL available. Ready to use with ECOLIGHT SMART CITY control solution.

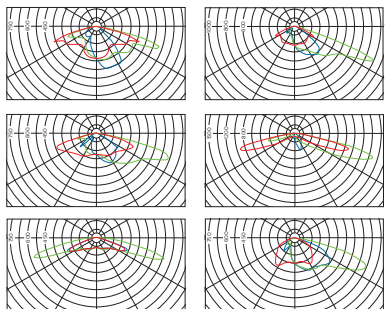

Good to know: The system can be mounted on horizontal and vertical poles.

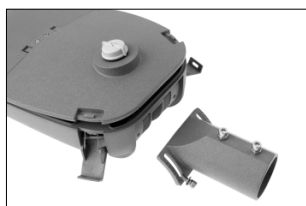

REGI NB SR DALI
REGI Zigbee SR DALI

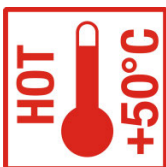

CE	EL28	PLUS*	PZH*	TECEE CB SCHEME
LED	IP66	IK09	DALI (optional)	

GENERAL TECHNICAL SPECIFICATIONS

Supply Voltage	220-240V AC
Supply Frequency	50-60 Hz
RFI Suppression	EN 55015 / CISPR 15
Immunity	EN 61547
Harmonics	EN 6100-3-2
Operating Temperature	-40 - +50 °C
Storage Temperature	-40 - +60 °C
Housing material, features	Corrosion resistant, UV protected aluminium housing
Enclosure Rating	IP66
Lid material	Tempered Glass
Mech. impact protection	IK09
Protection class IEC	Safety class I or II (optional)

Number of LED modules	1
Lamp family code	Philips FastFlex or TRIDONIC (optional)
Light colour K	3000, 4000 or 5700
Colour Rendering Index	> 70 or > 80
Useful life L90B50 at Ta 50 °C	100.000 h
Driver /power unit/	PHILIPS XITANIUM or TRIDONIC (optional)
Flickering	IEEE 1789
THD	< 20%
Power factor (full load at 230V)	> 0.95
Driver efficiency	> 90%
Control method	1- 10V, LineSwitch or Dynadimmer LITE (DALI optional)
Dimming range	7 ...100 %
System Wattage	up to 50 W
System efficiency at max luminous flux	up to 147 lm/W
Sytem luminous flux (max)	up to 7.350 lm

* in process

GENERAL TECHNICAL SPECIFICATIONS

EAN	Ref.	Wattage	System efficiency at max luminous flux	System luminous flux (max)	Dimensions (mm)				Area (m ²)	
					D	L	W	H	S ₁	S ₂
4772049000971	ST-1M/6000/G2	20W	160 lm/W	3.200 lm	526	623	259	181	0,0306	0,0373
		30W	157 lm/W	4.710 lm						
		40W	152 lm/W	6.080 lm						
		50W	147 lm/W	7.350 lm						

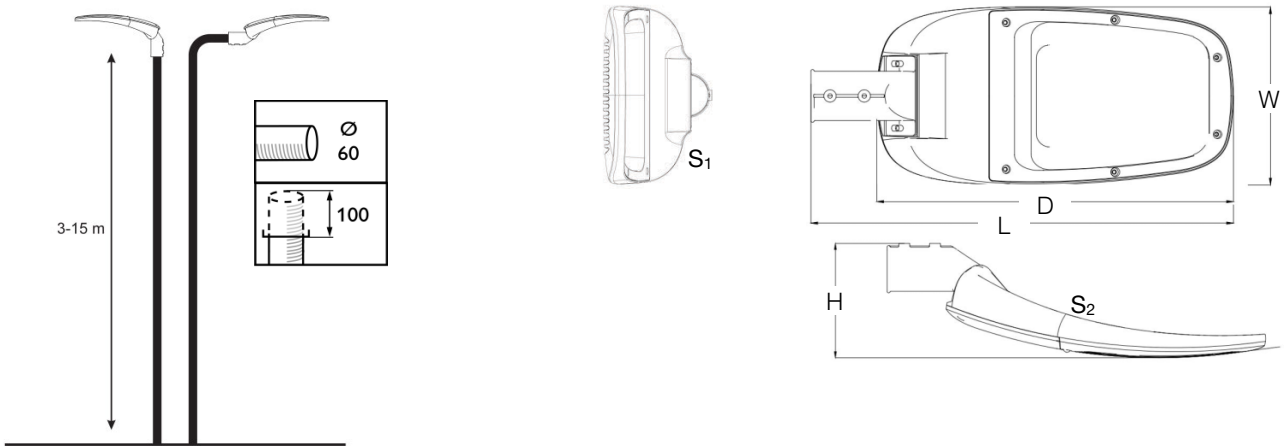

STANDARD OPTICS

FastFlex lens 2x8/II-X Gen2

Designed for narrow roads and urban street lighting.

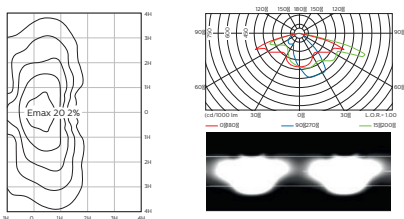

FastFlex lens 2x8/IV-X Gen2

Designed for wide roads and asymmetrical floodlighting.

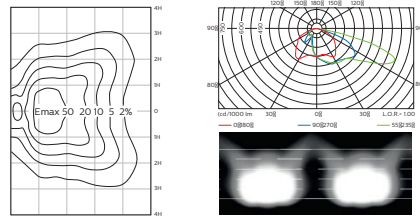

FastFlex lens 2x8/II-X WTR Gen2

Designed for wet road lighting.

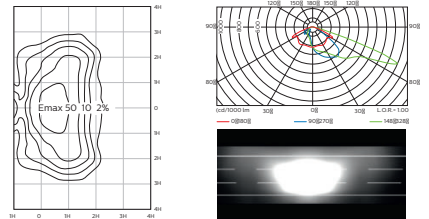

FastFlex lens 2x8/III-X Gen2

Designed for roads of medium width and urban street lighting.

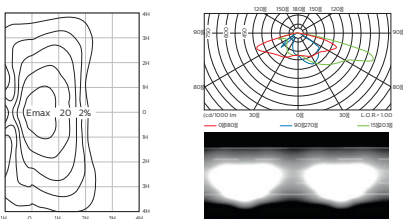

FastFlex lens 2x8/V Gen2

Designed for symmetrical lighting, e.g. parking lots, petrol stations.

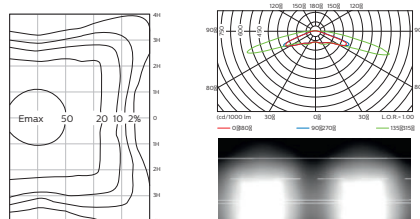

FastFlex lens 2x4/SW-X Gen2

Designed for Pedestrian Road and Bicycle lighting.

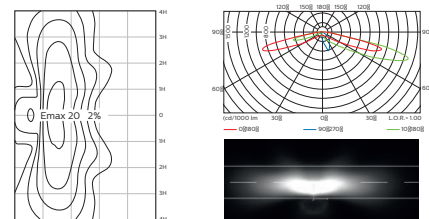

LED Luminaires and Retrofit Bulbs Licensing Program

Member **ECOLIGHT**. Save simple

ENABLED

**ISO 9001 - ISO 14001
OHSAS 18001**

**BUREAU VERITAS
Certification**

Ecolight™
Save simple.

ELEKTROS TAUPYMO SPRENDIMAI, UAB
 Moletu str. 13, Didžioji Riešė (PC "Link Moletu"), Vilnius distr. 14028, Lithuania
 Liepu str. 15, Linksmakalnis, Kaunas distr. 53290, Lithuania
 E: info@ecolight.lt T: +370 5 2328207 F: +370 5 2784262
 W: www.ecolight.lt, www.ecolight-lights.co.uk

THE ENERGY-EFFICIENT LED STREET LIGHT

Model: ST-2M/6000/G2

RADIUS LED ST GEN2

ROAD LIGHTING AT ITS BEST

RADIUS LET ST street light showcases elegant compact design, and features state-of-the-art technologies from Philips. The system is equipped with Philips FastFlex modules and Philips Xitanium Outdoor drivers. FastFlex modules have a minimum lifetime of 120.000 hours. Other key features include a smart overhear prevention system, an efficient light angle control system, and a Dynadimmer function which allows energy-saving programmability. The system has great thermal characteristics, and can be utilised in temperatures ranging from – 40°C to + 50°C. To match the needs of different applications, RADIUS LED ST has six standard and many optics options from LEDiL available.

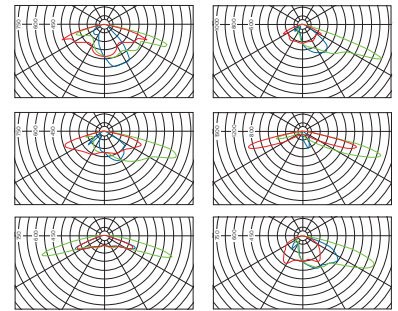

Good to know: The system can be mounted on horizontal and vertical poles.



REGI NB SR DALI
REGI Zigbee SR DALI



GENERAL TECHNICAL SPECIFICATIONS

Supply Voltage	220-240V AC
Supply Frequency	50-60 Hz
RFI Suppression	EN 55015 / CISPR 15
Immunity	EN 61547
Harmonics	EN 6100-3-2
Operating Temperature**	-40 - +50 °C
Storage Temperature	-40 - +60 °C
Housing material, features	Corrosion resistant, UV protected aluminium housing
Enclosure Rating	IP66
Lid material	Tempered Glass
Mech. impact protection	IK09
Protection class IEC	Safety class I or II (optional)

Number of LED modules	2
Lamp family code	Philips FastFlex or TRIDONIC (optional)
Light colour K	3000, 4000 or 5700
Colour Rendering Index	> 70 or > 80
Useful life L90B50 at Ta 50 °C	100.000 h
Driver /power unit/	PHILIPS XITANIUM or TRIDONIC (optional)
Flickering	IEEE 1789
THD	< 20%
Power factor (full load at 230V)	> 0.95
Driver efficiency	> 90%
Control method	1- 10V, LineSwitch or Dynadimmer LITE (DALI optional)
Dimming range	7 ...100 %
System Wattage	up to 100 W
System efficiency at max luminous flux	up to 149 lm/W
Sytem luminous flux (max)	up to 14.900 lm

* in process

GENERAL TECHNICAL SPECIFICATIONS

EAN	Ref.	Wattage	System efficiency at max luminous flux	System luminous flux (max)	Dimensions (mm)				Area (mm ²)	
					D	L	W	H	S ₁	S ₂
4772049000988	ST-2M/6000/G2	40W	162 lm/W	6.480 lm	595	693	310	181	0,0415	0,0394
		60W	159 lm/W	9.540 lm						
		80W	154 lm/W	12.320 lm						
		100W	149 lm/W	14.900 lm						

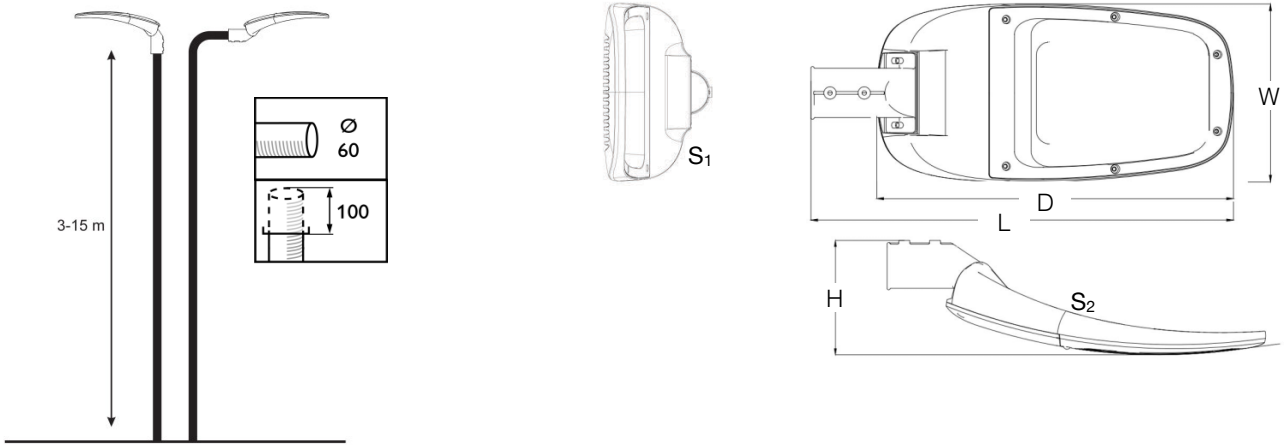

AVAILABLE OPTICS

FastFlex lens 2x8/II-X Gen2

Designed for narrow roads and urban street lighting.

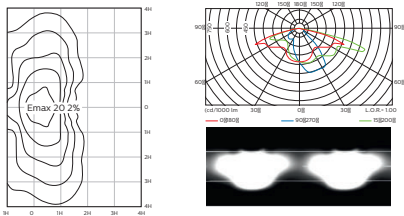

FastFlex lens 2x8/IV-X Gen2

Designed for wide roads and asymmetrical floodlighting.

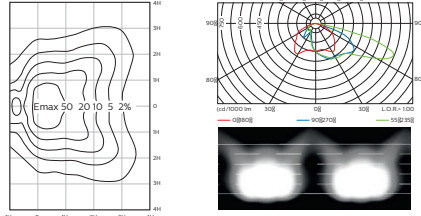

FastFlex lens 2x8/II-X WTR Gen2

Designed for wet road lighting.

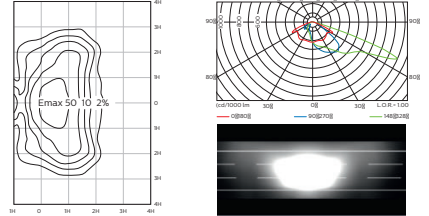

FastFlex lens 2x8/III-X Gen2

Designed for roads of medium width and urban street lighting.

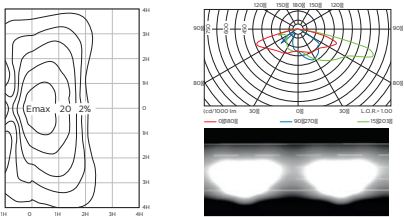

FastFlex lens 2x8/V Gen2

Designed for symmetrical lighting, e.g. parking lots, petrol stations.

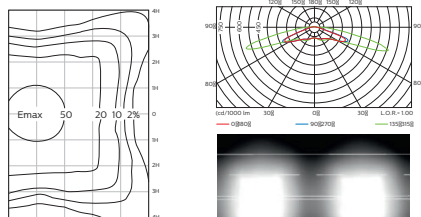

FastFlex lens 2x4/SW-X Gen2

Designed for Pedestrian Road and Bicycle lighting.

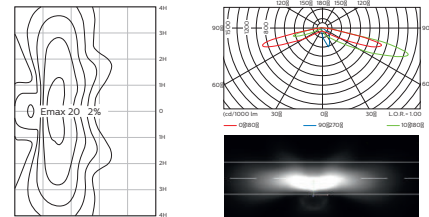

LED Luminaires and Retrofit Bulbs Licensing Program

Member **ECOLIGHT**. Save simple

ENABLED

**ISO 9001 - ISO 14001
OHSAS 18001**

**BUREAU VERITAS
Certification**

Ecolight™
Save simple.

ELEKTROS TAUPYMO SPRENDIMAI, UAB
 Moletu str. 13, Didžioji Riešė (PC "Link Moletu"), Vilnius distr. 14028, Lithuania
 Liepu str. 15, Linksmakalnis, Kaunas distr. 53290, Lithuania
 E: info@ecolight.lt T: +370 5 2328207 F: +370 5 2784262
 W: www.ecolight.lt, www.ecolight-lights.co.uk

THE ENERGY-EFFICIENT LED STREET LIGHT

Model: ST-3M/6000/G2

RADIUS LED ST GEN2

ROAD LIGHTING AT ITS BEST

RADIUS LED ST street light showcases elegant compact design, and features state-of-the-art technologies from Philips. The system is equipped with Philips FastFlex modules and Philips Xitanium Outdoor drivers. FastFlex modules have a minimum lifetime of 120.000 hours. Other key features include a smart overhear prevention system, an efficient light angle control system, and a Dynadimmer function which allows energy-saving programmability. The system has great thermal characteristics, and can be utilised in temperatures ranging from -40°C to +50°C. To match the needs of different applications, RADIUS LED ST has six standard and many optics options from LEDiL available.

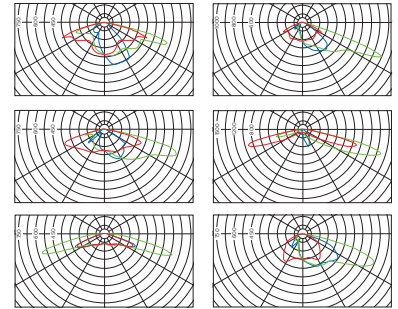

Good to know: The system can be mounted on horizontal and vertical poles.



REGI NB SR DALI
REGI Zigbee SR DALI



GENERAL TECHNICAL SPECIFICATIONS

Supply Voltage	220-240V AC
Supply Frequency	50-60 Hz
RFI Suppression	EN 55015 / CISPR 15
Immunity	EN 61547
Harmonics	EN 6100-3-2
Operating Temperature**	-40 - +50 °C
Storage Temperature	-40 - +60 °C
Housing material, features	Corrosion resistant, UV protected aluminium housing
Enclosure Rating	IP66
Lid material	Tempered Glass
Mech. impact protection	IK09
Protection class IEC	Safety class I or II (optional)

Number of LED modules	3
Lamp family code	Philips FastFlex or TRIDONIC (optional)
Light colour K	3000, 4000 or 5700
Colour Rendering Index	> 70 or > 80
Useful life L90B50 at Ta 50 °C	100.000 h
Driver /power unit/	PHILIPS XITANIUM or TRIDONIC (optional)
Flickering	IEEE 1789
THD	< 20%
Power factor (full load at 230V)	> 0.95
Driver efficiency	> 90%
Control method	1- 10V, LineSwitch or Dynadimmer LITE (DALI optional)
Dimming range	7 ...100 %
System Wattage	up to 150 W
System efficiency at max luminous flux	up to 149 lm/W
Sytem luminous flux (max)	up to 22.350 lm

* in process

GENERAL TECHNICAL SPECIFICATIONS

EAN	Ref.	Wattage	System efficiency at max luminous flux	System luminous flux (max)	Dimensions (mm)				Area (mm ²)	
					D	L	W	H	S ₁	S ₂
4772049000995	ST-3M/6000/G2	60W	162 lm/W	9.720 lm	595	693	310	181	0,0415	0,0394
		90W	159 lm/W	14.310 lm						
		120W	154 lm/W	18.480 lm						
		150W	149 lm/W	22.350 lm						

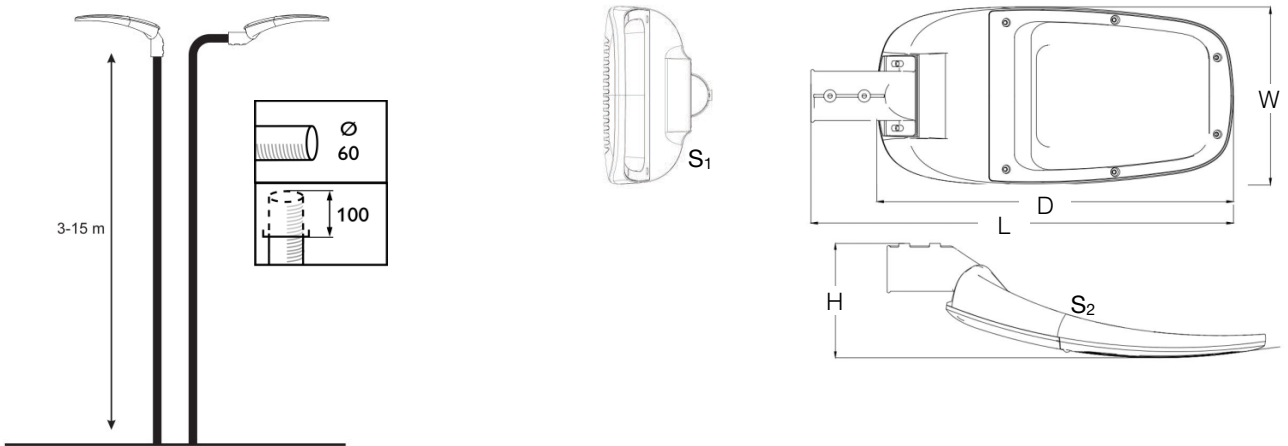

AVAILABLE OPTICS

FastFlex lens 2x8/II-X Gen2

Designed for narrow roads and urban street lighting.

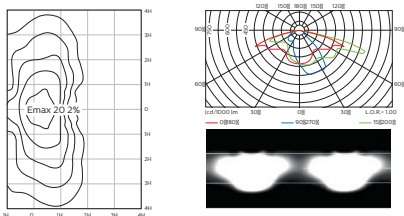

FastFlex lens 2x8/IV-X Gen2

Designed for wide roads and asymmetrical floodlighting.

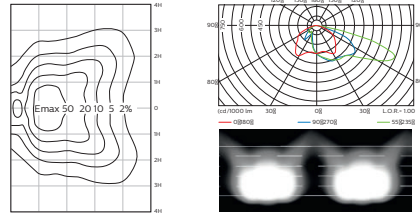

FastFlex lens 2x8/II-X WTR Gen2

Designed for wet road lighting.

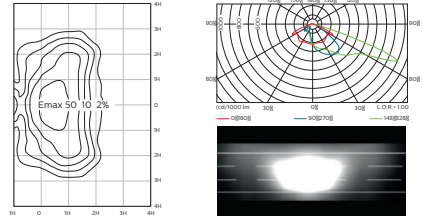

FastFlex lens 2x8/III-X Gen2

Designed for roads of medium width and urban street lighting.

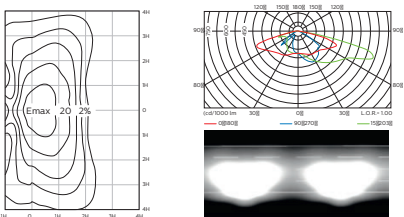

FastFlex lens 2x8/V Gen2

Designed for symmetrical lighting, e.g. parking lots, petrol stations.

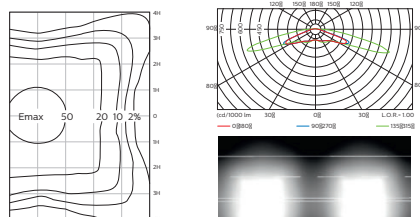

FastFlex lens 2x4/SW-X Gen2

Designed for Pedestrian Road and Bicycle lighting.

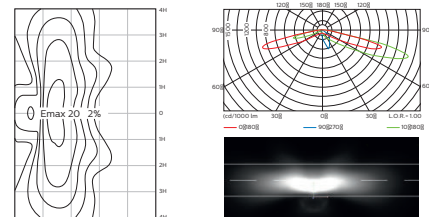

LED Luminaires and Retrofit Bulbs Licensing Program

Member **ECOLIGHT**. Save simple

ENABLED

**ISO 9001 - ISO 14001
OHSAS 18001**

**BUREAU VERITAS
Certification**

Ecolight™
Save simple.

ELEKTROS TAUPYMO SPRENDIMAI, UAB
 Moletu str. 13, Didžioji Riešė (PC "Link Moletu"), Vilnius distr. 14028, Lithuania
 Liepu str. 15, Linksmakalnis, Kaunas distr. 53290, Lithuania
 E: info@ecolight.lt T: +370 5 2328207 F: +370 5 2784262
 W: www.ecolight.lt, www.ecolight-lights.co.uk

MARAMA

SOL

OFF-GRID SYSTEM

MARAMA SOL OFF-GRID SYSTEM

Models: MS-1M/6000/360/MH/S, MS-1M/6000/360/MH, MS-1M/6000/720/MH, MS-2M/6000/720/MH

GAME CHANGER IN SOLAR LIGHTING

MARAMA SOL OFF GRID STREET LIGHT SYSTEM is designed specifically for outdoor off-grid applications where electricity from the grid is not available or is very unreliable.

- MARAMA SOL luminaries are compact, easy to transport, easy to assemble, and easy to transform or upgrade using a system of modular components.
- Because it is an autonomous, self-managing, it requires little to no maintenance.
- MARAMA SOL functions on light-on-demand principle, turning light on when necessary, changing light intensity when appropriate, and optimising energy consumption when possible.
- The users have the option to intervene and change the system's plan. The lighting regime can be altered by just a couple clicks on a remote control.
- Photovoltaic panels are mounted vertically which optimises the collection of solar power and prevents the gathering of dirt, snow and bird droppings.
- The use of cutting-edge components and dimming functionality makes this solar system effective even in Northern countries lacking sunshine.

Good to know: MARAMA SOL is a future proof system, ready for ECOLIGHT's smart solar solution based on IoT (Internet of things) technology - ECOMAS.

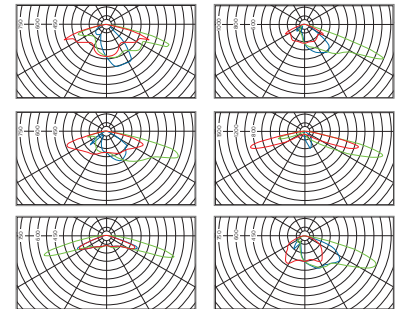
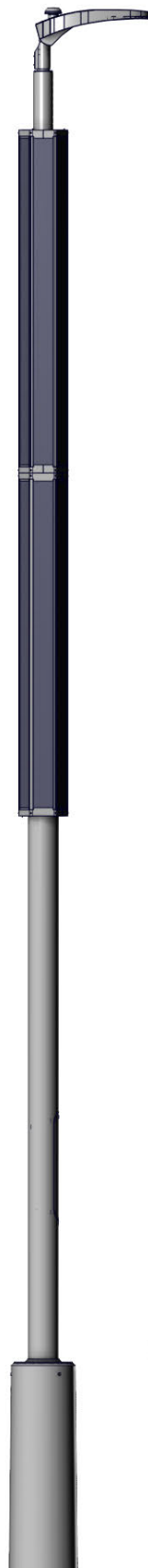

Made in EU



Best price-quality ratio



Environmentally friendly



Remote control



Automatic switch on/off function



Programmable



Long life time



Configurable dimming timer



Generously equipped solution



REGI NB 485



* in preparation



EcolightTM
Save simple.

ELEKTROS TAUPYMO SPRENDIMAI, UAB

Moletu str. 13, Didzioji Riese (PC "Link Moletu"), Vilnius distr. 14028, Lithuania
Liepu str. 15, Linksmakalnis, Kaunas distr. 53290, Lithuania
E: info@ecolight.lt T: +370 5 2328207 F: +370 5 2784262
W: www.ecolight.lt, www.ecolight-lights.co.uk

GENERAL TECHNICAL SPECIFICATIONS

	MS-1M/6000/360/MH/S	MS-1M/6000/360/MH	MS-1M/6000/720/MH	MS-2M/6000/720/MH
EAN	4772049003026	4772049002913	4772049002920	4772049002937
Wattage	up to 30W	up to 30W	up to 30W	up to 60W
Street light model	MARAMA SOL 30W 360WH NI-MH SOUTH	MARAMA SOL 30W 360WH NI-MH	MARAMA SOL 30W 720WH NI-MH	MARAMA SOL 60W 720WH NI-MH
Standards	EN 60598-1, EN 60598-2-3, EN 62471, EN 55015, EN 13032-1			
Lighting category according to EN13201	ME5 / ME6 / S2 / S3 / S4 / S5 / S6			
Typical application	Residential streets, private driveways, walking paths, urban local roads, parking lots, bicycle lanes, industrial areas			
LED light housing material	Aluminum			
Enclosure Rating	IP66 (applies to the whole system)			
Lamp family code	PHILIPS Fortimo FastFlex			
Light colour K	3000, 4000 or 5700			
Colour Rendering Index	> 70 or > 80			
Optics	Choice of 6 standard and many Ledil optics			
Control method	Programmable			
Dimming range	10 ...100 %			
PV panel	140W Monocrystalline	280W Monocrystalline	280W Monocrystalline	280W Monocrystalline
Panel dimensions	1560x230x230 mm	3120x230x230 mm	3120x230x230 mm	3120x230x230 mm
Charger	MPPT 10A	MPPT 10A	MPPT 10A	MPPT 10A
Battery protection	Yes			
Remote control	Yes	Yes	Yes	Yes
Battery	Ni-MH 30Ah/12V	Ni-MH 30Ah/12V	Ni-MH 60Ah/12V	Ni-MH 60Ah/12V
System autonomy	up to 12 hours*	up to 12 hours*	up to 24 hours*	up to 12 hours*
Temperature range	-20 °C to + 50 °C			
Ready for "self-learning" system	Yes			
Pole	Included			
Pole height	4,9 meters	6,5 meters	6,5 meters	6,5 meters
Component storage	Inside the pole			
Construction material	Galvanised steel			
Motion detector	Optional			

* if batteries are charged in full.



**ISO 9001 - ISO 14001
OHSAS 18001**

**BUREAU VERITAS
Certification**



ELEKTROS TAUPYMO SPRENDIMAI, UAB
 Moletu str. 13, Didzioji Riese (PC "Link Moletu"), Vilnius distr. 14028, Lithuania
 Liepu str. 15, Linksmakalnis, Kaunas distr. 53290, Lithuania
 E: info@ecolight.lt T: +370 5 2328207 F: +370 5 2784262
 W: www.ecolight.lt, www.ecolight-lights.co.uk

SMART CITY CONTROL SYSTEM

Models: REGI Zigbee SR DALI, REGI NB SR DALI, REGI NB 485



REGI is a secure, connected lighting management platform that is helping cities become more efficient and sustainable. REGI provides full visibility and control of your city's street lighting from a centralised dashboard, allowing you to securely monitor light points, set schedules, and adjust light levels on demand. Easy to use web applications provide a complete view of your connected street lights, enabling you to manage workflows and deploy maintenance crews only when and where needed. System data gives you near real-time insights into energy use and cost, helping you plan and schedule more efficiently.

BENEFITS AT A GLANCE

- Improved decision making

Manage lighting, measure energy use, monitor system health and diagnose problems from a single intuitive dashboard.

- Rapid return on investment

Switching to LED street lighting immediately reduces energy costs. Combining LED with the insights into usage and remote diagnostics available from the lighting management system, saves you even more and helps recoup your investment quickly.

- Flexible with open standards

REGI integrates with any type of sensor ready luminaire equipped with ZHAGA Book 18 standard connector giving you freedom to choose the luminaire supplier which works best for you.

- Powerful solution for solar lighting

REGI NB 485 is ready to work with RS485 drivers which are usually used in solar lighting. WEB-based software has implemented smart algorithm to analyse historical weather data, and import weather forecasts. By analysing past and future weather data and matching this data with its current energy production coefficients, the system programs the most efficient lighting regime under the current circumstances. In essence, your solar light becomes a self-learning machine that always works to optimise the balance between energy production and energy usage for lighting. This feature helps to keep solar lights operational whole year long in geographical areas with limited sunshine hours.

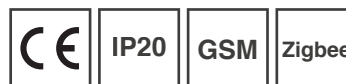

TECHNICAL SPECIFICATIONS OF ANTENNA



Supply Voltage	12 / 24V DC
Power consumption	<1,5 W
Communication	Zigbee or NB IoT
Interface	DALI 2.0 or RS 485
Operating Temperature	-40 - +50 °C
Storage Temperature	-40 - +60 °C
Relative humidity	<95% non-condensing
Material	ABS plastic
Enclosure Rating	IP66
Mounting	ZHAGA B18 standard connector

TECHNICAL SPECIFICATIONS OF A GATEWAY (goes only with REGI Zigbee)



Communication	Uplink support WIFI, 4G, network port access to the Internet, multi-network simultaneous online, downlink reservation optional multiple wireless communication, Zigbee, LoRa, Bluetooth, etc.
WiFi function mode	Support AP, STA, Repeater multiple modes
Network compatibility	Fully compatible with 2G, 3G, 4G network
Interface	4-channel WAN port, 232 serial port, 485 serial port, USB and 4-channel AD/IO interface
Supply Voltage	12 / 24V DC
Power consumption	~3,0 W
Operating Temperature	-40 - +50 °C
Storage Temperature	-40 - +60 °C

GENERAL TECHNICAL SPECIFICATIONS

EAN	Ref.	Communication	Interface	Dimensions (mm)			Weight (kg)
				L	W	H	
4772049004740	Antenna REGI Zigbee SR DALI	Zigbee	DALI 2.0	50	50	30,5	0.1
4772049004757	Antenna REGI NB SR DALI	NB IoT	DALI 2.0	50	50	30,5	0.1
4772049004764	Antenna REGI NB 485	NB IoT	RS 485	50	50	30,5	0.1
4772049004771	Gateway SZ11-GJ-3	2G/3G/4G/ZIGBEE/ LoRa/WAN/WiFi	4-channel WAN port, 232 serial port, 485 serial port, USB and 4-channel AD/IO interface	147	58,5	147	0,8
4772049004788	Web-based software						
4772049004795	Web-based software (incl. local deployment)						

HOW IT WORKS?

REGI Zigbee SR DALI

REGI Zigbee system needs a gateway which communicates with server that executes user commands (such as lighting switching on/off or dimming). Gateway sends and receives data to and from each separate antenna via Zigbee protocol. Gateway connects to internet network via GSM, LoRa or Ethernet depending on user choice. Gateway needs to be installed not more far away than 50 meters from the first antenna. Gateway gets to the internet either using GSM SIM card, LoRa or Ethernet line.

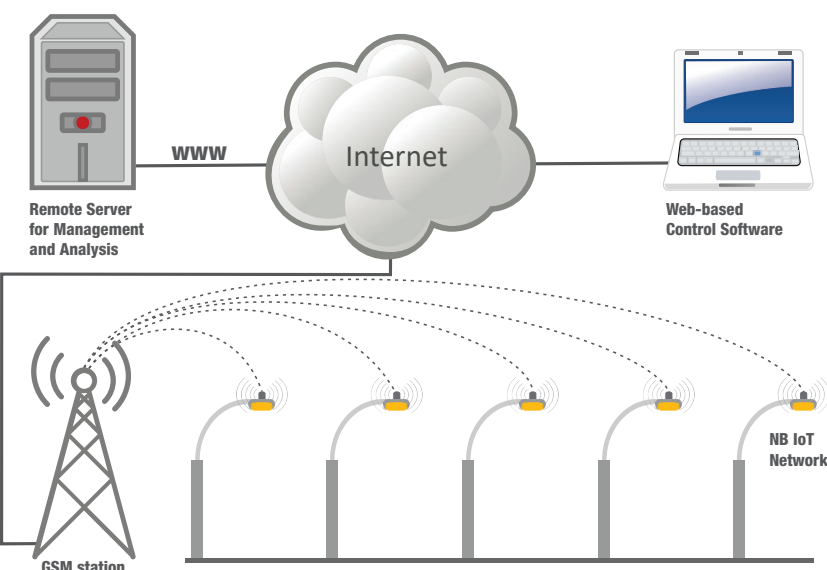
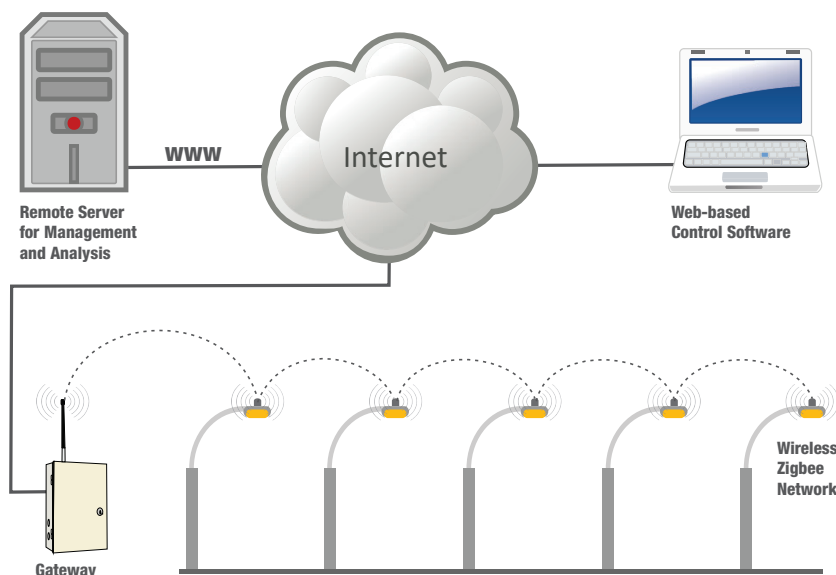

REGI NB SR DALI and REGI NB 485

REGI NB system has antenna's which works on NB IoT technology and communicates with GSM station directly why it does not need a gateway. Server that executes user commands (such as lighting switching on/off or dimming) sends and receives data to and from each antenna using NB IoT communication directly. To use this option is necessary to have a NB IoT service contract with local GSM provider.

ISO 9001 - ISO 14001
OHSAS 18001

BUREAU VERITAS
Certification



Ecolight™
Save simple.

ELEKTROS TAUPYMO SPRENDIMAI, UAB
Moletu str. 13, Didzioji Riese (PC "Link Moletu"), Vilnius distr. 14028, Lithuania
Liepu str. 15, Linksmakalnis, Kaunas distr. 53290, Lithuania
E: info@ecolight.lt T: +370 5 2328207 F: +370 5 2784262
W: www.ecolight.lt, www.ecolight-lights.co.uk

WEB-BASED SOFTWARE

Powerful supervising tool

An advanced dispatcher supervising tool for continuous streetlight monitoring, alerting and management.

Luminaire dimming profiles

Configure, select, and apply to luminaire; just three quick steps to setup or edit dimming profile to street lighting. Apply profiles for each luminaire in the system with easy to use interactive map interface.

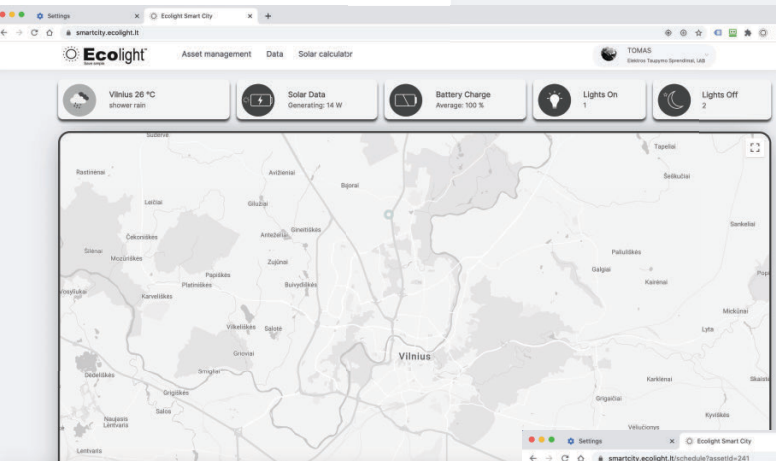
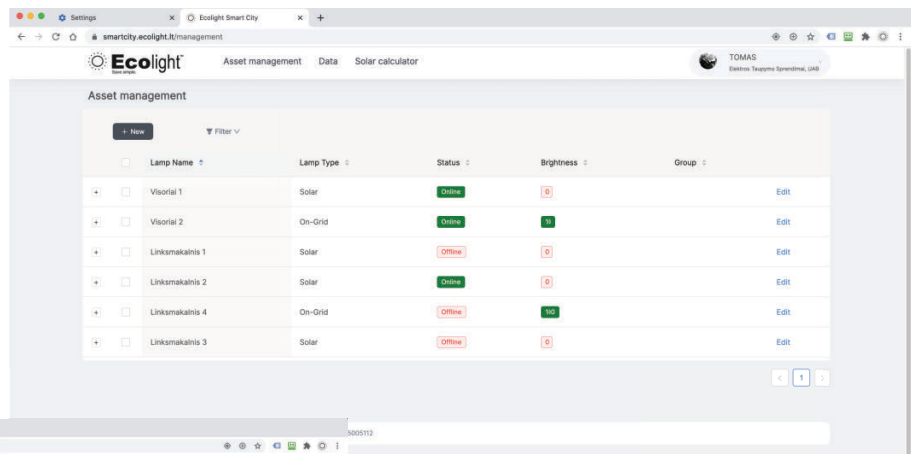

Interactive maps

Using interactive maps user can quickly apply or change luminaire dimming profiles. Maps will provide information overview of the whole streetlight components and their state.

Reports and measurements

Continuous interactive graphs provide information like current, voltage and consumption on both levels groups and single luminaire level.

Register and event tracking

Streetlight servicing history, tracking, or failure occasions can be stored and reported even years after the event. Highlighted failure indication and notification through E-MAIL and SMS services in real time on screen.

Reports and measurements

Continuous interactive graphs provide information like current, voltage and consumption on both levels groups and single luminaire level.

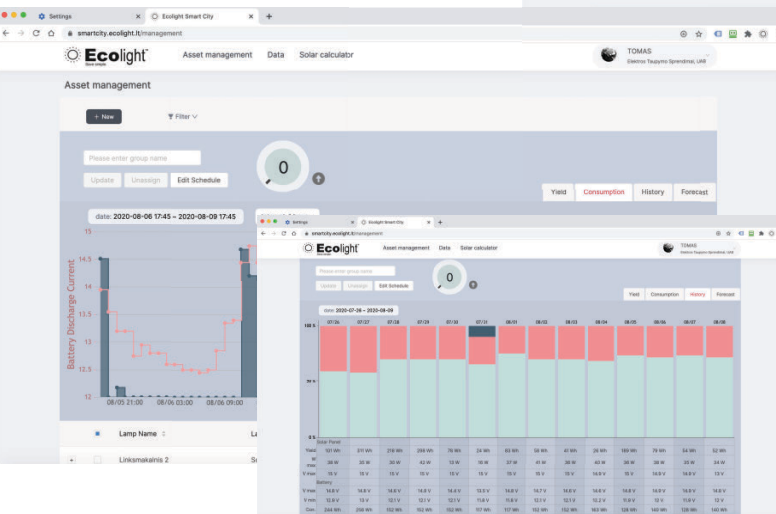
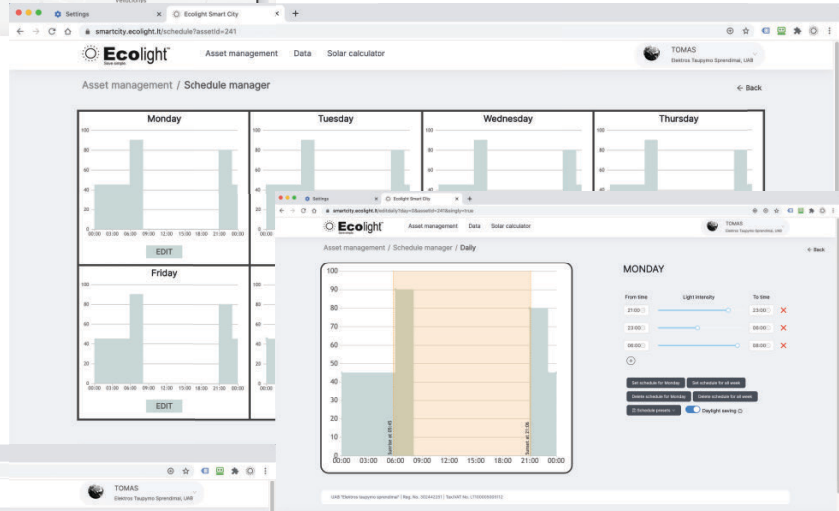

Local deployment

Software might be stored either on ECOLIGHT servers either deployed on customers servers to avoid service fee.

**ISO 9001 - ISO 14001
OHSAS 18001
BUREAU VERITAS
Certification**



























Ecolight™
Save simple.

ELEKTROS TAUPYMO SPRENDIMAI, UAB
Moletu str. 13, Didžioji Riese (PC "Link Moletu"), Vilnius distr. 14028, Lithuania
Liepu str. 15, Linksmakalnis, Kaunas distr. 53290, Lithuania
E: info@ecolight.lt T: +370 5 2328207 F: +370 5 2784262
W: www.ecolight.lt, www.ecolight-lights.co.uk

SENSORS

<p>REF: EBDHS</p> <p>The EBDHS PIR (passive infrared) presence detector provides automatic control of lighting loads with optional manual control. The EBDHS is a high sensitivity PIR detector suitable for high bay applications, such as warehouses and factories, and where high detection sensitivity is needed. Provides dimmable control of DALI ballasts.</p> <p>The EBDHS-LT30 range of high sensitivity detectors is perfect for this application with its operating temperature of -30°C and detection range of up to 40 m.</p>		<p>REF: SNH200</p> <p>Philips EasySense SNH200 (passive infrared) for high bay is the ideal solution for per-fixture control of new light fixtures for industrial high bay applications. It combines occupancy sensing, daylight harvesting and task tuning in a single, compact package for easy OEM fixture assembly or installation in the field.</p> <p>EasyAir operates with the established Philips Xitanium SR LED driver standard of a simple two-wire connection between the sensor and the driver, thus eliminating the need for multiple components and auxiliary devices.</p>	
<p>REF: EBMPIR</p> <p>The EBMPIR-MB series of batten mount PIR presence detectors provide automatic control of lighting loads. It has been specifically designed for mounting onto a batten style luminaire. The direct dim variant controls DALI or DSI digital dimming ballasts, whilst the analogue dim variant controls 1-10V dimming ballasts.</p> <p>The EBMPIR-MB-LT30 range is perfect to use in car parking or low bay freezer room application where the temperature is aggressively cold to -30°C.</p>		<p>REF: SNS300</p> <p>Philips EasyAir SNS300 (passive infrared) for networks is based on Zigbee technology for use in wireless systems for indoor connected lighting. It provides a simple solution to actively manage and control energy usage, while remotely adjusting light settings and determining service needs.</p>	
<p>REF: EBDHS-MB</p> <p>The EBDHS-MB luminaire mount high bay PIR presence detector range provides exceptionally sensitive and long range detection. The detectors are ideal for high bay lighting control in areas with demanding spaces and increased mounting heights such as warehouses and factories. Provides dimmable control of DALI ballasts.</p> <p>The EBDHS-LT30 range of high sensitivity detectors is perfect for this application with its operating temperature of -30°C and detection range of up to 40 m.</p>		<p>REF: HF2 SR</p> <p>Designed for integrated applications, the HF sensor modules feature the latest technology from STEINEL. Connection is extremely easy as it is made directly via the Philips XITANIUM SR interface. They require no additional control units nor do they involve any major installation work. It is operated via remote control for practical convenience.</p> <p>High-frequency technology enables the sensor to be installed in completely enclosed luminaries.</p>	
<p>REF: REGI NB SR DALI</p> <p>AC NB SR DALI GPS street light control antenna (node).</p>		<p>REF: smartSWITCH HF 5DP</p> <p>This sensor provides simple cost-effective motion detection. When the sensor detects movement it triggers a predefined motion detection profile in the control gear. If the user-definable light value at the integrated light sensor is exceeded the control gear remains switched off.</p> <p>High-frequency technology enables the sensor to be installed in completely enclosed luminaries.</p>	
<p>REF: REGI Zigbee SR DALI</p> <p>AC Zigbee SR DALI GPS street light control antenna (node).</p>		<p>REF: SZ11-GJ-3</p> <p>Universal gateway (2G/3G/4G/ZIGBEE/LoRa/WAN/WiFi) to work in combination with REGI Zigbee SR DALI antennas (nodes).</p>	
<p>REF: REGI NB 485</p> <p>DC NB 485 GPS solar light control antenna (node).</p>			

SUSPENSION SETS & ITEMS

EAN	Ref.	Description	Picture	EAN	Ref.	Description	Picture
4772049000797	HF12FR	HF CLASSIC LOOP END FIXING NO.1 (0-10 KG) 2M		4043952670712	99008405	Eye bolts M5	
4772049000841	HF12ECSEXP	HF EXPRESS SNAP-ON MINI HOOK END FIXING NO.1 (0-15 KG) 2M		4043952670873	99008406	Eye bolts M8	
4772049000803	HF12ECS	HF CLASSIC SMALL SNAP-ON HOOK END FIXING NO.1 (0-10 KG) 2M		4043952715062	99008407	Carabiner hook M6	
4772049000810	HF12EF6	HF CLASSIC STUD M6 END FIXING NO.1 (0-10 KG) 2M		4772049001633	99016401	STUCCHI 3 POLE FAST CONNECTION	
4772049000827	HF22EF8	HF CLASSIC STUD M8 END FIXING NO.2 (10-45 KG) 2M		4772049001640	99016402	STUCCHI 5 POLE FAST CONNECTION	
4772049000780	HF12EO90	HF CLASSIC 90° EYELET END FIXING NO.1 (0-10 KG) 2M		4772049001107	99008410	3 x 1.5 mm² solid wire	
4772049000834	HF12SP	HF CLASSIC TOGGLE END FIXING NO.1 (0-10 KG) 2M		4772049001121	99008411	3 x 2.5 mm² solid wire	
4772049000858	SQCM612EC	SQUEEZE LOCK CENTRAL EXIT M6 MALE NO.1 (0-15 KG) 2M HOOK END FIXING		4772049001084	99008412	3 x 1.5 mm² soft wire	
4772049000926	YF12EC500	Y-FIT CLASSIC SNAP-ON HOOK NO.1 (0-10 KG) 2M - LEG LENGTH 500MM		4772049001114	99008413	3 x 2.5 mm² soft wire	
4772049000919	YF12EC300	Y-FIT CLASSIC SNAP-ON HOOK NO.1 (0-10 KG) 2M - LEG LENGTH 300MM		4772049001091	99008518	3 x 1.5 mm² soft wire (chemically resistant)	
4772049000896	YF12ECS300	Y-FIT CLASSIC MINI SNAP-ON HOOK NO.1 (0-10 KG) 2M - LEG LENGTH 300MM		4772049001152	99008514	5 x 1.5 mm² solid wire	
4772049000902	YF12ECS500	Y-FIT CLASSIC MINI SNAP-ON HOOK NO.1 (0-10 KG) 2M - LEG LENGTH 500MM		4772049001176	99008515	5 x 2.5 mm² solid wire	
4772049002807		Y-FIT / SINGLE (UNIVERSAL) LINAS OFFICE 1,5M SUSPENSION		4772049001138	99008516	5 x 1.5 mm² soft wire	
				4772049001169	99008517	5 x 2.5 mm² soft wire	
				4772049001145	99008519	5 x 1.5 mm² soft wire (chemically resistant)	
					99008412	FENOSOL® S 10 UVA Anti-Static cleaning agent with a very weakly abrasive effect, for white profile surfaces. Controls the attraction of dirt and dust. Qty: 1000 ml	

CERTIFICATES

<p>ISO 9001:2015</p> <p>BUREAU VERITAS CERTIFICATION</p> <p>ECOLIGHT as a professional lighting manufacturer, provider of lighting installation, maintenance, testing and commissioning services is committed to developing and maintaining a Quality Management System in accordance with the requirements of ISO 9001:2008.</p>		<p>ENEC MARK</p> <p>BBJ Association of Polish Electricians</p> <p>ENEC is the high quality European Mark for electrical products that demonstrates compliance with European standards (EN). ENEC means safety in Europe, and all signatories of the ENEC Mark Scheme actively support its commitment to the highest safety levels.</p>	
<p>ISO 14001:2015</p> <p>BUREAU VERITAS CERTIFICATION</p> <p>As a manufacturer of energy efficient lighting ECOLIGHT understands great importance of protecting the environment in which we live. ECOLIGHT has implemented an environmental care system with the objective of company's activity in compliance with the environmental legislation.</p>		<p>DIN 18032-3 AND EN 13964</p> <p>UNIVERSITY OF STUTT GART</p> <p>LUMINA and SAULA models are tested for the ball throwing safety of an installation element according to DIN 18032-3:1997-04 "Sport halls; Halls for gymnastics, games and multi-purpose use; as well as the impact resistance of a ceiling element" according to EN 13 964 Annex D. This Certification means that LUMINA and SAULA units are safe to use in Sport Halls without any additional protection cage.</p>	
<p>OHSAS 18001:2007</p> <p>BUREAU VERITAS CERTIFICATION</p> <p>Being social enterprise and employing people with disabilities ECOLIGHT recognises the importance of managing occupational health, safety and welfare throughout all our operations and activities and we regard it as integral to our overall business strategy.</p>		<p>POLAND PZH CERTIFICATE</p> <p>NATIONAL HYGIENE INSTITUTE (POLAND)</p> <p>The National Hygiene Institute (PZH) certificate of approval for sale and usage of ECOLIGHT luminaries.</p>	
<p>CE MARK</p> <p>ECOLIGHT & EGSC</p> <p>All ECOLIGHT luminaries complies with the requirements of the Low Voltage Directive 2006/95/EB and EN 60598-1 Also with the requirements of the European Electromagnetic Compatibility (EMC) Directive 2004/108/EB: EN55015 for radio disturbance, EN61547 for EMC immunity and EN6100-3-2, EN6100-6-1, EN6100-6-3 for harmonics.</p>		<p>CNBOP Certificate of Admittance</p> <p>THE NATIONAL AND RESEARCH CENTRE FOR FIRE PROTECTION</p> <p>Certificates of Admittance issued by The National and Research Centre for Fire Protection issues is only required on territory of Poland according to Act issued 24.08.1991 regarding fire protection (O.J. 2009 no. 178, pos. 1380), together with executive acts.</p>	
<p>CityTouch Ready partnership</p> <p>PHILIPS LIGHTING B.V.</p> <p>The CityTouch Ready partner certification confers the ability to assemble CityTouch control components into luminaries, to configure and program these luminaries as CityTouch Ready luminaries, and sell these luminaries as CityTouch Ready luminaries to Philips Lighting's end-customers.</p>		<p>SASO certification</p> <p>SAUDI INSPECTION AND TESTING CO</p> <p>The Saudi Standards, Metrology and Quality Org. (SASO) has certified SAULA LED LN and ELUMA LED ZL luminaries according to SASO 2902:2018 and classified as A class energy efficient luminaries. More certified products are coming soon.</p>	

REFERENCES

LITHUANIA

COMPANY	PRODUCTS	INDUSTRY
UAB "EUGESTA" Vilijos str. 2, LT-02242, Vilnius www.eugesta.lt	LUMINA T5	
UAB "VILNIAUS TRANZITAS" Metalo g. 2A, LT-02190 Vilnius www.vtranzitas.lt	LUMINA T5	
UAB "FUDO" Taikos ave. 96, LT-51178 Kaunas, Lithuania www.fudo.lt	ELUMA T5	LOGISTICS
UAB "SANITEX" Raudondvario str. 131 LT-47501, Kaunas www.sanitex.eu	LUMINA T5 ELUMA T5 T8-T5 adaptors	
UAB "Vingės terminalas" Verslo g. 11, LT-94102, KLAIPĖDA www.vingesterminas.lt	LUMINA LED SAULA LED LN ELUMA LED	
AB "Lietuvos geležinkeliai" Mindaugo str. 12, Vilnius LT-03603 www.litrail.lt	ELUMA T5	RAILWAYS
AB "CITY SERVICE" Lvovo str. 25, LT-09308 Vilnius www.cityservice.lt	T8-T5 adaptors	SERVICE
UAB Švyturys-Utenos alus (part of CARLSBERG) Pakalnes str. 9, Vilnius www.svyturys.lt, www.utenosalus.lt	SAULA LED LN ELUMA LED ZL SKY PANELS LED	BEVERAGE
COCA-COLA HBC LIETUVA, UAB Alytaus gamykla Miskininku str. 19, LT-62200, ALYTUS www.coca-cola.lt	ELUMA T5 SAULA LED LN	
UAB "MAXIMA LT" Savanorių pr. 247 LT-02300 Vilnius www.maxima.lt	ELUMA T5 T8-T5 adaptors	
UAB "RIMI LIETUVA" Savanorių pr. 16, 03116 Vilnius www.rimi.lt	ELUMA T5 T8-T5 adaptors	RETAIL
UAB „PALINK“ Lentvario g. 33, LT-02241 Vilnius www.iki.lt	T8-T5 adaptors	
MECHEL NEMUNAS, UAB Kalantos g. 83, LT-52005 Kaunas www.mechelnemunas.lt	LUMINA T5	
Peikko Lietuva, UAB Naglio g. 4A, LT-52367 Kaunas www.peikko.lt	LUMINA T5	
UAB "STIKLO GAMINIAI" (GLASS LT) Naujoji g. 136-3, LT-62175, Alytus www.stiklogaminiai.lt	ELUMA T5	
UAB "KORELITA" Pramonės pr. 4, LT-51329 Kaunas www.korelita.lt	ELUMA T5 T8-T5 adaptors	
UAB "SAPA PROFILIAI" Taikos ave 106, Kaunas LT-51170 www.sapa.lt	LUMINA T5 T8-T5 adaptors	
AB "AKSA" Elektrenu str.10, LT-51218, Kaunas www.aksa.lt	ELUMA T5 LUMINA T5	
UAB "DOMINARI SOFA" Klaipėdos g. 147A, LT-37373 Panevėžys www.dominari.lt	LUMINA T5 SAULA LED	
UAB "MTL spaustuvė" Dariaus ir Girėno g. 99, LT-02189 Vilnius www.mtlcarton.com	SAULA T5	
UAB "DPD Lietuva" Liepkalnio g. 180, Vilniaus m., Vilnius www.dpd.lt	SAULA T5	PRODUCTION
UAB "Grigiškės" Vilniaus g. 10, Grigiškės, LT-27101 Vilnius www.grigiskes.lt	LUMINA LED	
UAB "Lavisos koncernas" Sukilėlių pr. 20, LT-50157 Kaunas www.lavisa.lt	LUMINA T5	
UAB "VISAGINO LINIJA" Pramonės g. 4, Karlių k. LT-30270, Visaginas www.sba.lt	SAULA T5	
UAB "Stansefabrikken" Pašilės g. 10, LT-20194 Ukmergė http://www.stansefabrikken.lt	SAULA T5	
UAB "Šilutės dūrpės" Šilų g. 2, Traksėdžiai, LT-99104 Šilutės r. www.klasmann-deilmann.com	LUMINA LED LN SKY PANELS	
UAB "Ecowood" Vilkija, LT-54222 Kauno r. www.ecowood.eu	ELUMA LED	
UAB "BARDUVA" Liepkalnio g. 61, Vilnius LT-02120, Lietuva www.barduva.eu	ELUMA LED	
UAB "Fazer Lietuva" Raudondvario pl. 129a, LT-47188 Kaunas www.fazer.lt	ELUMA LED PD	

LITHUANIA

COMPANY	PRODUCTS	INDUSTRY
UAB "Fazer Lietuva" Raudondvario pl. 129a, LT-47188 Kaunas www.fazer.lt	ELUMA LED PD	
UAB "Baltijos Brasta" Palemono g. 7b, LT-52158 Kaunas www.baltijosbrasta.lt	ELUMA LED PD	
UAB JUBANA Gamyklos g. 45, LT-89103 Mažeikiai www.jubana.lt	ELUMA LED PD	
UAB "Liningas" Pramonės g. 4, LT- 51329 Kaunas www.liningas.lt	ELUMA LED PD	
UAB "Samsonas" Europos prospektas 89, LT-46333 Kaunas www.samsonas.lt	ELUMA LED PD	
UAB "Fasa" Stoties g. 10, LT-68112, Marijampolė www.fasa.lt	SAULA LED LN	PRODUCTION
UAB "Randers Reb International" Naujoji g. 130, LT-62175 Alytus www.randers-reb.lt	ELUMA LED PD	
AB "SNAIGĖ" Pramonės g.6, LT-62175, Alytus www.snaige.lt	SAULA LED LN	
UAB "Liutukas ir Ko" Alovės g. 15, LT-46344 Kaunas info@liutukas.lt	ELUMA LED PD	
AB "Grigeo Klaipėdos Kartonas" Alovės g. 15, LT-46344, Kaunas www.grigeo.lt	ELUMA LED PD	
UAB "Albright Lietuva" Kretainio g. 4, LT-94103 Klaipėda www.albrightinternational.com	ELUMA LED PD	
UAB "Agrokonzernas" Užnerio g. 15, LT-47484 Kaunas www.agrokonzernas.lt	SAULA LED LN	AGRO
UAB "Kaunas Aircraft Maintenance Services" (Ryanair) Oro Uosto g. 4, Karmėlava, LT-54460 Kauno r. www.kams.lt	SAULA LED LN	AIRPORT
UAB "Ambertonas" Taikos pr. 98, LT-51177 Kaunas www.ambertonas.lt	ELUMA LED PD	LOGISTICS
UAB "Lavisos LEZ terminalas" Terminalo g. 6, Biruliškių km, Kauno raj., LT-54469 www.lez-terminalas.lt	SAULA LED LN ELUMA LED PD	
HAMPIDJAN BALTIC Pakruojo g. 34, Šiauliai 76126 www.hampidjan.is	SAULA LED LN	PRODUCTION
PEIKKO LIETUVA, UAB R. Kalantos g. 49, Kaunas 52303 www.peikko.lt	LUMINA LED LUMINA SAULA LED LN	
VOLFAS ENGELMAN, UAB Kaunakiemio g. 2, LT-44354 Kaunas www.volfasengelman.lt	ELUMA LED ZL	BREWERY
UAB "Inter Cars Lietuva" Titnago g. 6, LT-02300 Vilnius www.intercars.lt	ELUMA LED PD	WHOLESALE
UAB "Bennet distributors" Metalo g. 2B, LT-02190 Vilnius www.bennet.lt	LUMINA T5	
UAB "Novameta" Draugystės g. 15D, LT-51227 Kaunas www.novameta.lt	SAULA LED LN	
UAB "Arimex" Kirtimų g. 49, LT-02244 Vilnius www.arimex.lt	ELUMA LED ZL	
UAB "Mantinga" Stoties g. 51, LT-68261 Marijampolė www.mantinga.lt	ELUMA LED ZL	PRODUCTION
UAB "Camira fabrics" Žemaičių g. 47, Ariogala, LT-60252 Raseinių r. www.camirafabrics.com	ELUMA LED ZL SAULA LED LN	
UAB "Kaefer" Ringuvos g. 65A, LT-45245 Kaunas www.termoizola.lt	ELUMA LED ZL	
Šiaulių teniso mokykla, VšĮ Gardino g. 8, LT-78232 Šiauliai www.siauliaitennis.lt	SAULA LED LN	TENNIS HALL
UAB "Kauno vaisių ir daržovių prekyba" Ateities pl. 75A, LT-52104 Kaunas www.kaunovaisiai.lt	ELUMA	FOOD
UAB "Spaudos kontūrai" Pašilaičių k., Zujūnų sen., LT-14158 Vilniaus r. www.s-k.lt	SAULA LED LN	PRINTING HOUSE
UAB "Skirliūta" Kauno g. 3-2, Miklūsėnai, LT-62461 Alytaus r. www.apziura.lt	SKY PANEL ELUMA	SERVICES

POLAND

COMPANY	PRODUCTS	INDUSTRY
INS Lighting Reymonta 56, 80-290 Gdańsk www.inslighting.pl	ALL PRODUCTS	DISTRIBUTION
TELMEX Sp. Z o.o. Ul. Gdańska 22, 12-200 Pisz www.telmex.com.pl	SAULA LED	
ADAMS Ul. Giżycka 5, 11-700 Mrągowo www.adams.com.pl	SAULA T5 SAULA LED	
GLOBMETAL Ul. Drowcowa 56, 76-004 Sianów www.globmetal.eu	LUMINA T5	
Dovista sp. z o.o. Wędkowy 83-115 Swarzędz www.sanitex.eu	T8-T5 adaptors	
KAPEO POLSKA sp. z o.o. ul. Strażacka 3, 83-321 Mściszewice www.kapeco.com.pl	ELUMA T5	
ALLTEAMS Abrahama 10, 84-300 Lębork www.alteams.com	SAULA T5	
SATEL sp. z o.o. Ul. Budowlanych 66, 80-298 Gdańsk www.satel.pl	T8-T5 adaptors	PRODUCTION
GREINER PACKAGING sp. Z o.o. Al.XX-lecia 54, 96-515 Teresin www.greiner-gpi.com	SAULA LED ELUMA LED ZL	
CP Glass S.A. Oddział Huta Szkła „Orzesze” ul. Gliwicka 59, 43-180 Orzesze www.hso.pl	SAULA LED LN XT	
LUBAWA S.A. ul. Waryńskiego 32-36, 86-300 Grudziądz www.lubawa.com.pl	ELUMA LED SKY PANEL LED	
Wojskowe Zakłady Uzbrojenia S.A. Parkowa 42, 86-300 Grudziądz, Poland www.wzu.pl	SAULA LED	
Federal - Mogul Gorzyce Sp. z o.o. ul. Odlewników 52, 39 - 432 Gorzyce Polska www.wzu.pl	SAULA LED SAULA LED XT ELUMA LED	
BLACK RED WHITE S.A. ul. Krzeszowska 63, 23-400 Biłgoraj www.brw.com.pl	SAULA LED ELUMA LED ZL ECOLINE LED	
DAJAR Sp. z o.o. ul. Poławska 6, 75-072 Koszalin http://www.dajar.pl	ELUMA LED ZL SAULA LED	DISTRIBUTION
KORNIX Sp. z o.o. ul. Kościarska 18 83-250 Skarszewy	LUMINA LED	
MAZURY Sp. z o.o. ul. Przemysłowa 8, 14-100 Ostróda www.ostmazury.pl	SAULA LED LN	
CONVEX-GLASS Sp. z o.o. Chmiełek 204B, 23-412 Łukowa www.convexglass.pl	ELUMA LED ZL	
TREFFL S.A Plac Dwóch Miast 1, 81-731 Sopot www.treffl.com	ELUMA LED ZL SAULA LED LN	
ZAKŁAD PRODUKCJI OPAKOWAŃ KARTON-PAK S.A. ul. Hutnicza 10-12, 67-100 Nowa Sól www.kartonpak.pl	ECOLINE LED	PRODUCTION
SERWISTAL Sp. z o.o. ul. Dojazdowa 2a 19-300 Elk www.serwistal.pl	LUMINA LED	
ORISTO Sp. z o.o. Montowo 59, 13-324 Grodziczno www.oristo.pl	ECOLINE LED ZL ELUMA LED	
SIM Gdynia Holding ul. Rewerenda 7 80-209 Chwaszczyno www.simgdynia.eu	ECOLINE LED ZL ELUMA LED SKY PANEL LED	
InBet Sp. z o.o. ul. Przemysłowa 10 83-050 Kolbudy www.inbet.com.pl	RADIUS LED	
KRISPAUL ul. Do studzienki 31 80-227 Gdańsk www.krispaul.pl	ZL ELUMA LED SKY PANEL LED	PRINTING HOUSE

COMPANY	PRODUCTS	INDUSTRY
VOLVO GROUP TRUCK CENTER ul. Szwedzka 9 32-050 Skawina	ELUMA LED ZL	TRUCK WORKSHOP
P.P.H. KROS Sp. z o.o. Iłownica 3 83-412 Głódowo kros.com.pl	SAULA LED	FOOD INDUSTRY
H+H Polska Sp. z o.o. ul. Kupiecka 6, 03-046 Warszawa HplusH.pl	SAULA LED XT ZL ELUMA LED	PRODUCTION
LUBIANA S.A. 83-407 Lubiana www.lubiana.com.pl	ZL ELUMA LED SAULA LED	
ETOS Sp. z o.o. ul. Bysewska 23, 80-298 Gdańsk www.etos.pl	ZL ELUMA LED	DISTRIBUTION
UNILEVER POLSKA S.A. ul. Józefa Ignacego Kraszewskiego 20 85-240 Bydgoszcz	SAULA LED	
DR. OETKER SP. Z O.O. ul. Dr. Augusta Oetkera 26 84-103 Łebcz	SAULA LED XT	
DROBEX SP. Z O.O. ul. Powstańców 19 86-050 Solec Kujawski www.drobex.com.pl	ZL ELUMA LED	FOOD INDUSTRY
MIELEWCZYK SP. Z O.O. ul. Podgórna 3 83-332 Dzierżążno www.mielewczyk.pl	ZL ELUMA LED SAULA LED INOX SAULA LED	

GERMANY

COMPANY	PRODUCTS	INDUSTRY
RMBH GmbH Steinweg 3-5, 91567 Herrieden, GERMANY www.rmbh.de	LED PRODUCTS	DISTRIBUTION
Weisert & Daur GmbH & Co. KG Benzstraße 9, 74076 Heilbronn www.weisert-daur.de	LUMINA LED LN	PACKING
Grafschafter Gymnasium Bankstraße 20, 47441 Moers, Germany www.grafschafter-gymnasium.de	SAULA LED LN	GYMNASIUM
Kessler & Co. GmbH & Co. KG Hüttlinger Str. 18-20, D-73453 Abtsgmünd www.kessler-axles.de	LUMINA LED LN	
HORSCH Maschinen GmbH Sitzenhof 1, 92421 Schwandorf www.horsch.com	LUMINA LED LN SAULA LED LN	AUTOMOTIVE
Johann Hoefler & Sohn GmbH & Co. KG Balbiererstraße 30, 90763 Fürth, Germany www.hoefler-und-sohn.de	SAULA LED LN	
Backhaus Grömminger GmbH Heimstettener Straße 1 85599 Parsdorf	LUMINA LED LN	PRODUCTION
CURTISS-WRIGHT INDUSTRIAL GROUP Schleissheimer Str. 91A, 85748 Garching, Germany	SAULA LED LN	
Linde Gas Vertriebspartner Technische Gase - Spedition Wüst GmbH & Co. KG Lehenwiesenweg 31, 91781 Weißenburg in Bayern, Germany	LUMINA LED LN	LOGISTICS
GIMA Gips- und Malerbedarf GmbH & Co Groß- und Einzelhandels KG Windmühle 11, 91567 Herrieden, Germany	LUMINA LED LN	RETAIL
Münster Therme Münsterstraße 13, 40477 Düsseldorf, Germany www.baeder-duesseldorf.de	ELUMA LED ZL	SERVICES
Ebalta Kunststoff GmbH Rothenburg ob der Tauber, 91541 Rothenburg ob der Tauber, Germany www.ebalta.de	LUMINA LED LN	
Vogel & Sohn GmbH & Co.KG Hardtstraße 22, 91522 Ansbach, Germany www.schrott-vogel.de	SAULA LED LN LUMINA LED LN	PRODUCTION
Schirmer Galvanotechnik GmbH Am Kieferschlag 18, 91126 Schwabach, Germany www.schirmer-galvanik.de	SAULA LED LN	
MAN Truck & Bus - Nuremberg plant Vogelweierstraße 33, 90441 Nürnberg, Germany www.mantruckandbus.com	SAULA LED LN LUMINA LED LN	AUTOMOTIVE
Liebherr-MCCTec Rostock GmbH Liebherstraße 1, 18147 Rostock, Germany www.liebherr.com	ELUMA LED ZL	PRODUCTION
Düsseldorf International Airport Flughafenstraße 105, 40474 Düsseldorf www.dus.com	SAULA LED LN	AIRPORT
Bädergesellschaft Düsseldorf mbH Kettwiger Straße 50 40233 Düsseldorf	SAULA LED LN	AQUA PARK

SLOVENIA

COMPANY	PRODUCTS	INDUSTRY
Kostroj Strojgradnja d.o.o. Tovarniška cesta 2, 3210 Slovenske Konjice, Slovenia www.kostroj.com	LUMINA T5	
AquafilSLO d.o.o. Letaliska Cesta, 15 – 1001 Ljubljana – SLOVENIA www.aquafil.com	SAULA LED LN	
ALPINA SHOES FACTORY Strojarska ulica 2, 4226 Žiri www.alpina.si	SAULA LED LN ELUMA LED ZL RADIUS LED ST	
SAVATECH, d.o.o. Industrial Rubber Products and Tyres Škofjeloška c. 6, SI-4000 Kranj, Slovenia www.savatech.eu	ELUMA LED PD	
Itw Metallflex, d.o.o. Poljubinj 89e, 5220 Tolmin, Slovenia www.itwmetallflex.com	SAULA LED LN SKY PANEL LED	
Unior kovaška industrija d.d. Kovaška cesta 10, 3214 Zreče, Slovenia www.unior.si	SAULA LED LN	PRODUCTION
Sij Acroni d.o.o. Cesta Borisa Kidriča 44, 4270 Jesenice, Slovenia www.sij.acroni.si	SAULA LED LN	
Etiketa, tiskarna, d.d. Industrijska ulica 6, 4226 Žiri, Slovenia www.etiketa.si	EUMA LED ZL	
Goričane tovarna papirja Medvode, d.d. Ladja 10, 1215 Medvode, Slovenia www.goricane.si	EUMA ZL T5	
Mufon, družba za usposabljanje in zaposlovanje invalidov, d.o.o. Stationery store in Radeče, Slovenia	ELUMA LED PD	
Papirnica Vevče d.o.o. 1261 Ljubljana - Dobrunje, Slovenia www.brigl-bergmeister.com	ELUMA LED PD	
Iskra ISD d.o.o. Savska loka 4, 4000 Kranj, Slovenia www.iskra-isd.si	ELUMA LED PD	
Lipar, proizvodno in trgovsko podjetje, d.o.o. Lahovče 31, 4207 Cerklje na Gorenjskem, Slovenia www.lipar.si	SAULA LED LN	RETAIL
Goodyear Dunlop Sava Tires, proizvodnja pnevmatik, d.o.o. Škofjeloška cesta 6, 4000 Kranj, Slovenia www.sava-tires.si	SAULA LED LN ELUMA LED PD	LOGISTICS
Tkk tovarna kemičnih izdelkov in proizvodnja krede Srpenica d.d. Srpenica 1, 5224 Srpenica, Slovenia www.tkk.si	ELUMA LED PD	PRODUCTION
Maksim D.O.O. Bežigrajska cesta 6, 3000 Celje, Slovenia www.maksim.si	SAULA LED LN, RADIUS, ELUMA ZL, SKY PANEL	PRODUCTION
ETERNIT D.O.O. Anhovo 9, 5210 Deskle www.esal.si	LUMINA LED LN	LUMINA LED LN

CROATIA

COMPANY	PRODUCTS	INDUSTRY
CALLIGARIS D.O.O. MAKSIMIRSKA 112, 10020 ZAGREB, Croatia www.calligaris.co.uk	SAULA LED LN ELUMA LED PD	PRODUCTION
Mundus Viridis d.o.o. Grabić 17, Gradec 10340, Vrbovec www.mundus-iridis.hr	LUMINA LED LN ELUMA LED ZL RADIUS LED ST	PRODUCTION
Brenta d.o.o. Klenovec Humski 89/1, 49231, Hum na Sutli www.brenta.hr	SAULA LED LN, ELUMA ZL, SKY PANELS	PRODUCTION
Town Krapina	RADIUS LED ST	MUNICIPALITY
Prostoria Pustodol Začretski 19G 49223 Sv. Križ Začretje www.prostoria.eu	SAULA LED LN	PRODUCTION

DENMARK

COMPANY	PRODUCTS	INDUSTRY
CANTOR LIGHT DESIGN Østerbrogade 226 DK-2100 København - Danmark www.cantorlightdesign.dk	ALL LED PRODUCTS	DISTRIBUTION
Ecofoss ApS Elmevej 8, Glyngøre (Jamohuset), 7870 Roslev www.ecofoss.dk	ALL LED PRODUCTS	
Rørving City Municipality	RON LED SAULA LED LN SAULA LED LP	MUNICIPALITY BUILDINGS
Valby-Hallen Julius Andersens Vej 3, 2450 København SV, Denmark	SAULA LED LN	SPORT ARENA

SERBIA

COMPANY	PRODUCTS	INDUSTRY
Peštan d.o.o. Put 1300 Kaplara 189, Arandelovac 34301 www.pestan.net	LUMINA LED LN ELUMA LED ZL	PRODUCTION
TOWN BABUŠNICA	RADIUS LED ST	MUNICIPALITY
Michelin Srbija Nikole Pašića 213, Piro 18300, Serbia www.tigar-tyres.com	SAULA LED LN	PRODUCTION
Termoprodukt RS-1 DOO Marka Aurelija bb, 22000 Sremska Mitrovica www.termoprodukt.com	SAULA LED LN, ELUMA ZL, SKY PANELS	PRODUCTION
Rollo Doors doo Drago Todorovic, Kragujevac, Serbia www.rollodoors.com	ELUMA ZL	PRODUCTION

ESTONIA

COMPANY	PRODUCTS	INDUSTRY
Rimi Eesti Food AS Põrguvälja tee 3, Pildiküla, Rae vald, Harjumaa www.rimi.ee	T8-T5 adaptors	RETAIL
Maxima Eesti OÜ Peterburi tee 47, 11415 Tallinn www.maxima.ee	T8-T5 adaptors	
Smelta OÜ Tööstuse 47, 10416 Tallinn, Estonia www.smelta.com	ALL LED PRODUCTS	DISTRIBUTION
Wendre AS Lina 31, 80041 Pärnumaa, Pärnu www.wendre.ee	SAULA LED LN	PRODUCTION
Loo Metall Linnuka tee 2, Jõelähtme, 74201 Harju maakond info@globen.ee	SAULA LED LN	PRODUCTION
Nataman AS Paljassaare tee 4, 10313 Tallinn www.netaman.ee	SAULA LED LN	PORT
DBT AS Koorma 13, Harjumaa, 74115 Harju www.dbtmuga.ee	LUMINA LED LN	LOGISTICS

LATVIA

COMPANY	PRODUCTS	INDUSTRY
SIA "RIMI LATVIA" A.Deglava 161, Rīga LV-1021 www.rimi.lv	T8-T5 adaptors	RETAIL
International Exhibition Center Kīpsalas iela 8, Rīga, LV-1048, Latvia www.rigaexpo.lv	ELUMA T5	EXHIBITION CENTER
PROELEKTRO SIA Tallinas str. 13, Rīga, Latvia, LV-1001 www.proelektro.eu	ALL PRODUCTS	DISTRIBUTION
AS "Latvijas Finieris" Bauskas iela 59, LV- 1004 Rīga www.finieris.lv	SAULA LED LN SAULA LED LP ELUMA LED PD	
Schoeller Allibert SIA Rītausmas street 2, LV-1058 Rīga info.riga@schoellerallibert.com	SAULA LED LN ELUMA LED PD	PRODUCTION
VALPRO, SIA L.Laicena iela 2, Valmiera LV- 420 valpro@valpro.lv	SAULA T5	
RAAP, SIA Antilērijas iela, 48, Rīga, LV-1009 www.raap.lv	ELUMA LED PD	
ALDARIS A/S Rīga, Tvaika iela 44, LV-1005 www.aldaris.lv	ELUMA LED ZL	BREWERY
BAUSKA MUNICIPALITY Uzvaras iela 1, Bauska www.bauska.lv	RADIUS LED	STREETS
ZS Amatnieki Baltinava Baltinavas novads, LV-4594	RAMUNE LED	FARMING
Brabantia Latvija SIA Darba iela 7, Pastende, Talsu nov. www.brabantia.com	SAULA LED LN ELUMA LED ZL	PRODUCTION
Elipse Blc Sia Airport Rīga, Mārupes nov. www.elipse-blc.lv	ECOLINE LED EC	LOGISTICS
Siera nams A/S Rāmuļu iela 25, Rīga www.sieranams.lv	ELUMA LED ZL	LOGISTICS
TC Kurši Salaspils, Zviedru iela 6 www.kurshi.lv	ELUMA LED ZL	LOGISTICS
Code, Codes pag., Bauskas nov.	RADIUS LED ST	MUNICIPALITY

MACEDONIA

COMPANY	PRODUCTS	INDUSTRY
I-Impuls Ltd TC Beverly Hills 1/11, 1000 Skopje, Macedonia www.i-impuls.mk	ALL PRODUCTS	DISTRIBUTION
BAS Tuti Fruti Skupi 20 bb, Skopje, Macedonia www.bastutifruti.com	ELUMA T5	PRODUCTION
Hemija Komerc	ELUMA T5	
Johnson Matthey DOOEL TIDZ Skopje 1, 1041 Ilinden, MACEDONIA http://ect.jmcatalysts.com	ELUMA T5	PRODUCTION
Detal VELD www.detalveld.com	ELUMA T5	
DUROPAK KOMUNA AD - SKOPJE Romanija str., bb 1040 Skopje - MACEDONIA www.komuna.com.mk	ELUMA T5	RETAIL
BADEV Kavadarci	ELUMA T5	
SC Boris Trajkovski www.scoristrajkovski.gov.mk	ELUMA T5	SPORT
LIRIJA School	ELUMA T5	FOOD INDUSTRY
LION Sv. Nikole Regionalen Pat R-105 bb Sveti Nikole, 2220, Macedonia www.lion.com.mk	ELUMA T5	
Swisslion доо ул. "Качанички пат" 83, 1000 Скопје http://swisslion.com.mk	ELUMA T5	PHARMACEUTICAL
ALKALOID AD SKOPJE Blvd. Aleksandar Makedonski 12, 1000 Skopje www.alkaloid.com.mk	ELUMA T5	
NELT ST DOOEL Skopje 32 br.20 1041 Ilinden www.neltst.mk	ELUMA LED ZL RADIUS LED ST	LOGISTICS

IRELAND

COMPANY	PRODUCTS	INDUSTRY
E. Kavanagh & Sons St Thomas Gate, Thomas St, Waterford, Ireland www.kavanaghslighting.ie	SAULA LED LN	DISTRIBUTION

AUSTRALIA

COMPANY	PRODUCTS	INDUSTRY
REMTRON AUTOMATION Melbourne, Unit 12/2 Sibthorpe Street, Braeside Vic 3195 www.remtron.com.au	ELUMA T5	DISTRIBUTION
Q Industries Pty Ltd 16 Fullarton Drive, VIC 3076 Epping, Australia www.qindustries.com.au	SAULA LED LN	DISTRIBUTION

NETHERLANDS

COMPANY	PRODUCTS	INDUSTRY
Gunneman BV 2e Industrieweg 4, 8051 CM Hattem www.gunneman.nl	ALL PRODUCTS	DISTRIBUTION

KINGDOM OF SAUDI ARABIA

COMPANY	PRODUCTS	INDUSTRY
AL SALEM KITCHENS AND LIGHTING CO. LTD P.O. BOX 11976 JEDDAH 21463 KSA www.kitchendesigners-ksa.com	SAULA LED	DISTRIBUTION
ASTRA FOOD CO. LTD 1485 Tabuk 71431, KSA www.astrafood.com	ELUMA LED ZL	PRODUCTION
Optimal Engineering Solutions LTD Office 3, Bldg 2980, Falsteen Str. P.O. Box 5475 JEDDAH 21422, KSA	SKY PANEL LED	HOTELS

U.A.E.

COMPANY	PRODUCTS	INDUSTRY
DEL MONTE FOODS (U.A.E) FZE Street 14 & 17, Central Fruit and Vegetable Market Area, Awir P.O. Box 294484, Dubai, UAE www.delmonte.com	SAULA LED ELUMA LED ZL	PRODUCTION

ITALY

COMPANY	PRODUCTS	INDUSTRY
GeneralLeds s.r.l. Via Albiroli 10, 40126 BOLOGNA - ITALIA www.generaleds.com	SAULA LED LN	DISTRIBUTION
MANLED LIGHTING s.r.l. Via Garibaldi Franceschi, 4 Borgo San Lorenzo 50032, Italy www.manled.it	SAULA LED LN	

JORDAN

COMPANY	PRODUCTS	INDUSTRY
Consolidated Energy & Economic Engineering Amman – Jordan www.cthreee.com	ALL LED PRODUCTS	DISTRIBUTION
Siniora Food Industries King Abdallah II Industrial City, Amman 11512, Jordan www.siniorafood.com	SAULA LED LN ELUMA LED ZL	FOOD INDUSTRY
Al Jabali Trading Group http://al-jabali.com	SAULA LED LN ELUMA LED ZL	LOGISTICS
AL HUSSAM PLASTICS INDUSTRIES LIMITED Po Box 184352 11134 Amman, Jordan www.alhussampack.com	ELUMA LED LD	PRODUCTION
National Poultry Company (NPC) Baider Wadi Al-Seir Industrial Area www.delmontearabia.com	SAULA LED LN ELUMA LED ZL	FOOD INDUSTRY
Intercontinental Jordan Hotel Islamic College Street, Amman 11180, Jordan www.intercontinental.com	LED retrofits	HOTELS
Crown Plaza Resort Dead Sea Dead Sea, 18186 Sowayma, Jordan www.crowneplaza.com	LED retrofits	
Crown Plaza Amman K. Faysal Ben Abdul Aziz St. Amman, Jordan www.crowneplaza.com	LED retrofits	PRODUCTION
Qatrana Cement Mecca Towers Center, Amman 11821 Jordan www.qcc.jo	RADIUS LED ST SAULA LED LN	
Huda Lighting Jordan Building Technology Suppliers King Abdullah II Bin Al Hussein St. Kalbouneh Center 1st Floor P.O. Box 3360 www.hudalighting.com	SAULA LED LN	WHOLESALE
HIKMA PHARMACEUTICALS AMMAN Amman, Jordan www.hikma.com	SKY PANEL	MEDICAL

CZECH REPUBLIC

COMPANY	PRODUCTS	INDUSTRY
NBB Bohemia s.r.o. Sídliště 693, 407 22 Benešov nad Ploučnicí, Czech Rep. www.nbb.cz	ALL PRODUCTS	WHOLESALE
LUMIDEE Svornosti 12, 150 00 Praha, Czech Republic www.lumidee.cz	LUMINA T5 SAULA T5 & LED ELUMA LED	
ALEDO s.r.o. Vodní 987/9, 796 01 Prostějov, Czech Republic www.aledo.cz	LED PRODUCTS	LOGISTICS
DHL	SAULA T5	
Velkoobchodní a logistické centrum EGT Velká Bystřice	SAULA T5	PRODUCTION
S.O.K. stavební, s.r.o. Žďárského 196, 674 01 Třebíč, Czech Republic www.sok.cz	SAULA LED LN	
TLP Kunice - hala D 2	SAULA T5	PRODUCTION
TRÍDIČ, s. r. o. Pískoviště 1663/3, 785 01 Šternberk, Czech Republic www.keestrack.com	SAULA LED	
HANAKOV, spol. s r.o. Pod Kosířem 3127/74, 796 03, Prostějov, Česká republika www.hanakov.cz	SAULA LED	HOSPITAL
Psychiatrická nemocnice Bohnice Ustavni 91, 181 02 Praha 8, Česká republika www.bohnice.cz	SAULA LED	
ISTAR USTI N/L Dráždanská 856/74B, 400 07 Ústí nad Labem- Neštémice-Krásné Březno http://www.istasro.cz	ELUMA LED ZL	BUILDING
ITW Pronovia, Ltd. Vlkovská 595, 595 01 Velká Bíteš www.itwpronovia.cz	SAULA LED LN	AUTOMOTIVE
CPI Moravia Books, s.r.o. Brněnská 1024, 691 23 Pohořelice www.cpi-print.cz	SAULA LED LN	PRINTING HOUSE
UNIMARCO a.s. 4. května 678, 763 11 Želechovice nad Dřevnicí www.unimarco.cz	SAULA LED LN	WHOLESALE
HPM Tec, Ltd. Herbenova 869/42, 693 01 Hustopeče www.hpmtec.cz	SAULA LED LN	WHOLESALE

Note: This reference list does not include all installations and sales and is only as indicative document to understand in which industries and countries our luminaries are being used.

WORLDWIDE PARTNERS

LITHUANIA



USI INTERNATIONAL, UAB

J. Kubiliaus g. 6-2, Vilnius LT-08234, Lithuania
+370 5 243 0300
usi@usi.lt, www.usi.lt

LATVIA



SIA PROELEKTRO

Mazjumpravas iela 32, Riga, Latvia, LV-1063
Tel. +371 67373718
proelektro@proelektro.lv, www.proelektro.lv

POLAND



INS Ewa Porzych

ul. Reymonta 56, 80-290 Gdańsk, Poland
Tel. +48 58 341 34 19
info@inslighting.pl, www.inslighting.pl

CZECH REPUBLIC



NBB BOHEMIA s.r.o.

40722 Benesov nad Ploucnic, Czech Republic
Tel. +420 414 120 560
hotmail@nbb.cz, www.nbb.cz

NETHERLANDS



Gunneman BV

2e Industrieweg 4, 8051 CM Hatterm
T +31 38 443 24 00
info@gunneman.nl, www.gunneman.nl

NORWAY



Q-LIGHT AS

Kongsgård Alle 62 4632 Kristiansand
T +37 905 36 641
post@qlight.no, www.qlight.no

GERMANY



RMBH GmbH

Steinweg 3-5, 91567 Herrieden, Germany
Tel. +49 9825 203829 10
info@rmbh.de, www.rmbh.de

JORDAN



Consolidated Energy & Economic Engineering

Tel. +962 6 4620050
info@cthreee.com, www.cthreee.com

FRANCE



L'ATELIER LUMIERE

123 rue Mac Mahon, 54000 Nancy, France
Tel. +33 3 83351014
contact@atelum.fr, www.atelum.fr

AUSTRALIA



Q Industries Pty Ltd

16 Fullarton Drive, VIC 3076 Epping, Australia
Tel. 03 9401 4666
info@qindustries.com.au, www.qindustries.com.au

NORTH MACEDONIA



I-Impuls Ltd

TC Beverly Hills 1/11, 1000 Skopje, Macedonia
Tel. +389 2 313 11 13
info@i-impuls.com.mk, www.i-impuls.com.mk

FINLAND



Greon Oy

Hakamaantie 23, 90440 Kempele
T +35 840 1546380
info@greon.fi, www.greon.fi

SLOVENIA



ERCO I d.o.o.

Žorgova ulica 27, 1231 Ljubljana, Slovenia
Tel. +386 1 750 61 97
info@erco.si

UNITED KINGDOM



FOTOLEC TECHNOLOGIES LTD

5 Baird Way, Thetford, IP24 1JA, UK
Tel. +44 1842 763 752
sales@glassguard.co.uk, www.glassguard.co.uk

ITALY



MANLED LIGHTING s.r.l.

50032 Borgo San Lorenzo, Florence, Italy
Tel. +39 055 8459840
info@manled.it, www.manled.it

SLOVENIA



ELBI I d.o.o.

Cesta 1. maja 75, 4000 Kranj, Slovenia
Tel. +386 41 321 155
info@elbi.si

MAROCCO



Solugy

1 rue Ohoud, Angle avenue Michlifen – Agdal Rabat
Tel. +212 5 37 68 18 91
contact@solugy.ma, www.solugy.ma

ECOLIGHT

Industry Disruptor

ECOLIGHT is a fast-growing company seeking to disrupt the global industry of LED lighting. As an official partner of SIGNIFY (former Philips Lighting), ECOLIGHT employs state-of-the-art lighting technologies to create ultra-efficient, yet reasonably priced luminaires. Our unique business and production model is encapsulated in our brand slogan: No Nonsense. Just Raw Efficiency.

Specialisation

ECOLIGHT's main specialisation is in the production of heavy-duty LED luminaires for factories and warehouses. Our industrial lighting systems are perfectly balanced to achieve excellent energy saving results, while also creating a healthy and efficient working environment. Moreover, ECOLIGHT's range of products includes special models for the food industry, models for chemically aggressive environments, vandal resistant luminaires, and luminaires compatible with extreme temperatures. In the last several years, ECOLIGHT has also branched out to other segments including street lights, intelligent solar street lights, office lights, and human-centric school lights.

Global Reach

ECOLIGHT's ENEC-certified products are sold in over twenty countries worldwide. Key markets include Germany, Slovenia, Poland, United Arab Emirates, Great Britain, Czech Republic, Latvia, Denmark, Jordan, Saudi Arabia, Ireland, and Italy. Products are distributed via a network of exclusive and reliable country partners. If you want to represent ECOLIGHT in your market, contact us at info@ecolight.lt. In 2019, ECOLIGHT is launching CamelsPanels.com, a direct trade platform for European-certified LED lights for office and service environments.

Social Responsibility

Since 2011, ECOLIGHT has been operating as a social enterprise. The company's factory is located in Linksmakalnis, Lithuania, where over sixty percent of all employees are people with various degrees of disability. Social responsibility, however, is not about hiring people with disabilities, but about empowering them. In 2018, our efforts in this area were recognised with an award for the most socially responsible enterprise in the region.

ECOLIGHT is an ISO 9001, ISO 14001 and OHSAS 18001 certified company.



ECOLIGHT consumes electricity, 100% of which is produced from renewable energy sources (RES).



Ecolight[™]
Save simple.

ELEKTROS TAUPYMO SPRENDIMAI, UAB
Moletu str. 13, Didžioji Riese (PC "Link Moletu"), Vilnius distr. 14028, Lithuania
Liepu str. 15, Linksmakalnis, Kaunas distr. 53290, Lithuania
E: info@ecolight.lt T: +370 5 2328207 F: +370 5 2784262
W: www.ecolight.lt, www.ecolight-lights.co.uk

ISO 9001 - ISO 14001
OHSAS 18001

BUREAU VERITAS
Certification

