

KITCHEN & BEDROOM LIGHTING RANGE 2016

LIGHTING INNOVATION WITH NO BOUNDARIES

We believe in pushing the boundaries.

Our focus on British lighting design, high quality products and maintaining an unrivaled support structure, is what sets us apart. We want to show you the future of LED furniture lighting.

We place our focus on doing things differently and dedicate our time to designing and developing the latest cutting edge lighting solutions, first. Products to truly inspire you and bring your designs to life. We are always looking for the very latest LED technology and features to integrate into our products, allowing you to fulfil all of your customers needs when designing their new kitchen or bedroom.

To further emphasise the value we place on the high quality of our products, we have a 5 year guarantee on our kitchen & bedroom fittings. Alongside this is our dedicated support structure, we offer comprehensive training and continuously improve our support structure, allowing us to offer the best guidance to all our customers. Our representatives all originate from the furniture industry so we truly believe we have the skills and understanding to meet your requirements.

M. Linsky

MICHAEL LINSKY
DIRECTOR





AWARD WINNING PRODUCT DESIGN







Contents

Why Sensio...

06	Company history
08	Product design - what sets us apart
12	Quality
16	Discover us online
20	Approved Retailer Programme
27	Point of sale

Planning your lighting scheme...

10	The importance of lighting
13	LED. The smart choice
14	Cool white vs. warm white
18	Software
22	A new way of living
24-26	Developing a lighting scheme
29	Where to position lights in your kitchen
112	Sensio products for every bedroom
141	Cable connect system
142	Connecting by colour

Building a reputation to be proud of.

Founded in 2000, Sensio has grown from a small, family run business operating from the family's garage, to a market leading authority on furniture lighting solutions. Still operating as a family business, we pride ourselves on bringing high quality, innovative UK product designs and excellent service to our customers year on year.

2008

New premises –
9,000 square feet

2007

The Sensio brand is launched

2000

Company founded
by the Linsky family

2002

First premises acquired at
a size of 2,000 square feet

2011

Recognition in KBB Innovation Awards Excel London

Winner in Kitchen Retailer Ireland Awards 2011

2013

Sensio Slovenia established

Sensio appoints their first product designer following a successful internship in 2012

Sensio move into their current premises – 29,000 square feet

2015

New Senior Product Designer joins the team

Sensio's third product design internship begins

The SLS Quadra launches - a unique Sensio product design

2010

Sensio America begins trading

Sensio Awarded Gold in The Design Awards from Designer magazine

2012

Sensio receives Best lighting award in the House Beautiful Awards

Sensio introduces first product design internship programme

2014

A 5 year guarantee is introduced on our kitchen/bedroom lighting products

The redesigned and redeveloped Sensio website launches

sensio[®]



PRODUCT
DESIGN
WHAT SETS
US APART

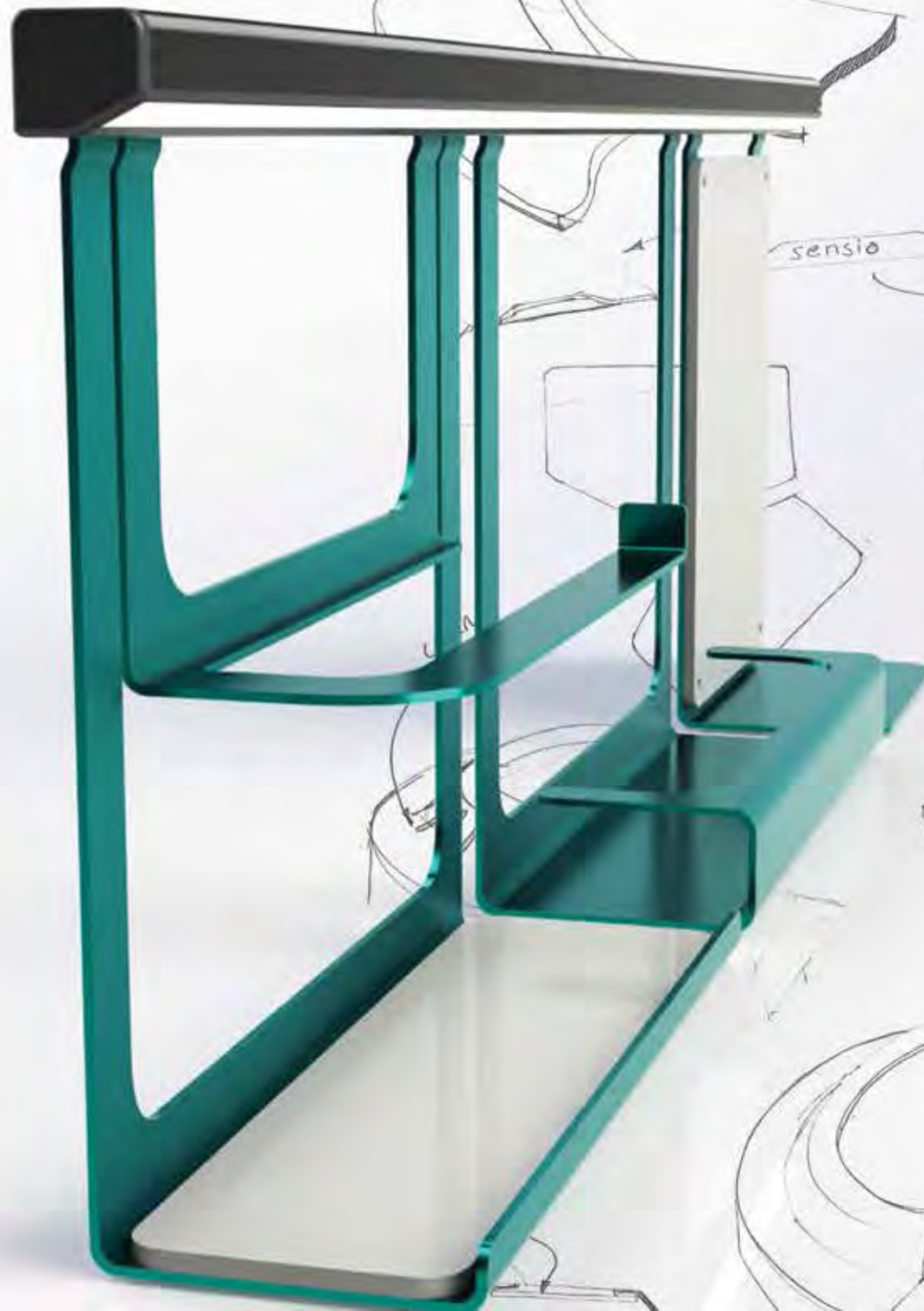

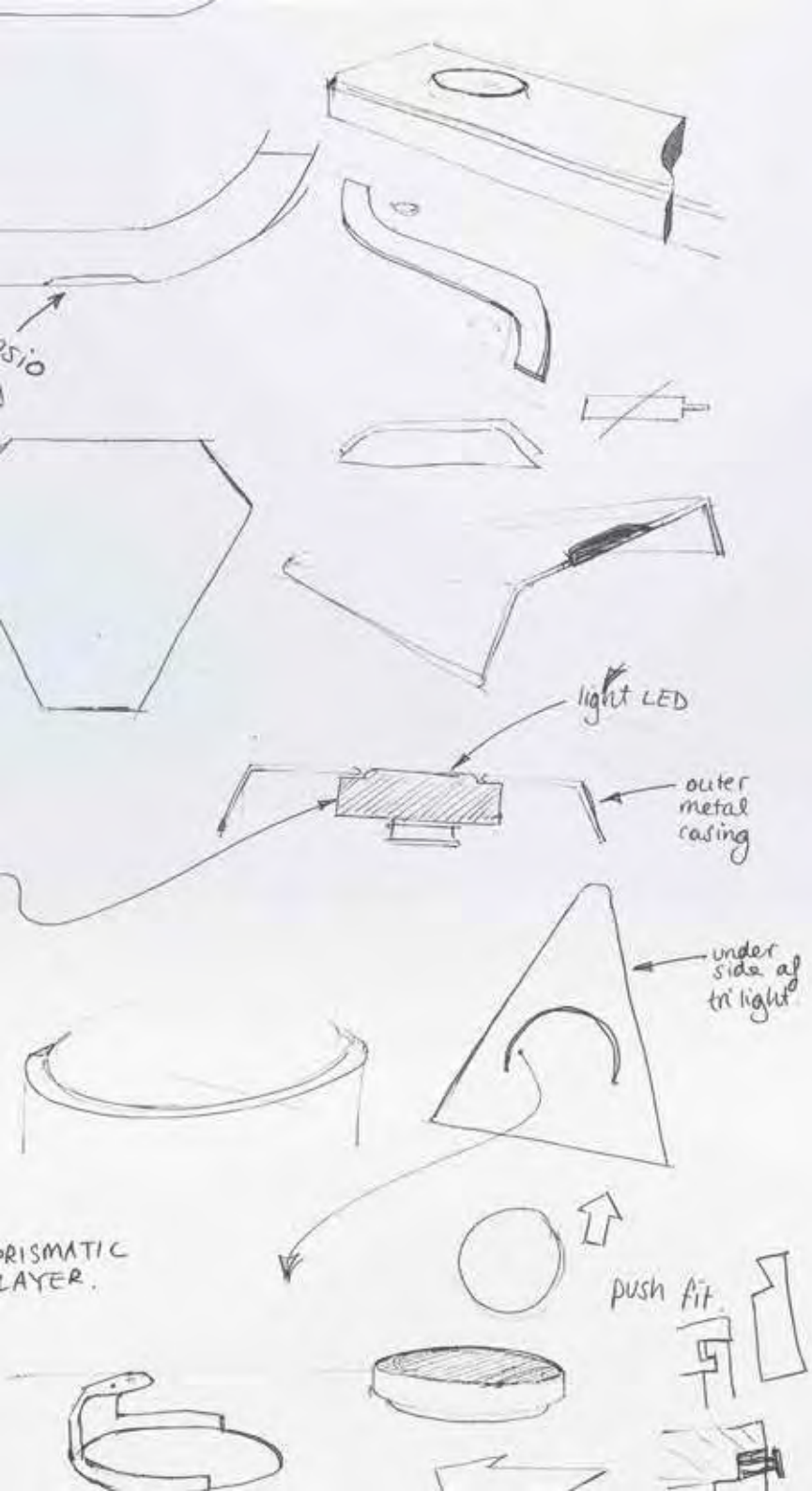

- > UK based product design and development department
- > Allows us to maintain the highest degree of control over our product offering
- > We can offer unique products which incorporate the latest LED technology, bespoke style & materials
- > Truly thinking differently about our upcoming new product designs. Designing, developing and perfecting
- > Pushing the boundaries of our industry
- > We keep fully abreast of the latest consumer opinions and market trends; it's what fuels our ideas for new product development and prototypes
- > We don't just think lighting, we think furniture to ensure our products have been designed to fit your furniture designs to the best degree
- > We also place a focus on constantly looking at improving our existing product offering, enhancing and upgrading products

See page 98 for the Sensio Midway Hanging Rail

The importance of kitchen lighting...

Lighting is no longer just a kitchen accessory, it's a necessity. Transform your kitchen designs by incorporating a lighting scheme in the initial design stages. Just look at how a lighting scheme transforms this kitchen which only has ceiling spot lights.



Before **sensio** lighting

innovate.
create.
illuminate.™



After **sensio** lighting



Quality is Priority.

5 Year Guarantee.

To reflect the high quality of our product portfolio, products in this catalogue come complete with a 5 year guarantee for your customers' peace of mind.

*For exclusions see www.sensio.co.uk/guarantee

At Sensio we pride ourselves on offering superior quality products, using the best components and materials to guarantee long-life performance, high light output and enhanced durability.



LED. The Smart Choice.

Want a better understanding of the benefits of investing in LED lighting for the home? Find out here why LED is fast becoming the only light to live by in the home...



The initial cost is outweighed by the benefits

Initial fitting costs:

- £15.72 - SLS Hype
- £5.76 - Halogen Surface Light plus replacement lamps - G4 capsule lamp at approximately £1.15 each (13 replacements required in the lifespan of the Hype) - £14.95

Annual electricity cost per fitting:

- £2.69 per year to run the Hype
- £28.97 per year to run halogen

* Readings taken using Belkin Conserve Insight Energy Use Monitor
The meter takes an average reading for the year based on 5 hours per day usage.



A lifespan of over 12 times longer

Sensio LED fittings last up to 50,000 hours.
A halogen fitting lasts only 4,000 hours.



More efficient light output

A halogen fitting has a light output of up to 320 lm, however the beam angle of a halogen fitting is 360 degrees meaning a large proportion of the light is dispersed and wasted rather than being useful light. With LED you can now achieve a light output of up to 285 lm from a single under cabinet spot light, with an average beam angle of 55 degrees, there is no light wastage.



Save **£131.40** per year on energy bills

You can see how choosing LED in the first instance may cost more initially but in the long run costs much less.



Constant advancements

Major advancements in LED technology are made year on year. This allows us to offer more innovative, advanced product designs allowing for a much more diverse range of products. There are differing LED technologies in our range which allows us to offer a range of products at different price points.

Colour Temperatures

The LED colour that you choose for your kitchen can make a huge impact! Use these pages as a guide to help you choose the best LED colour for your kitchen design.



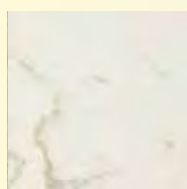

Marble



Sandstone

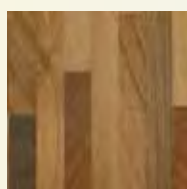

Walnut Timber



Black Granite, Gold Fleck



Grey Granite

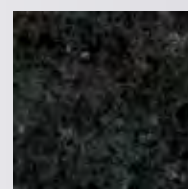

Slate

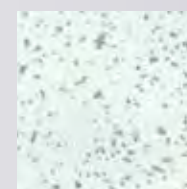

White Granite, Silver Fleck

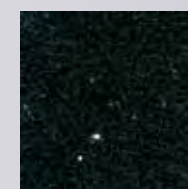

Granite, Silver Fleck



Oak Timbers



Oak Timbers



Oak, Walnut,
Beech or Ash



Painted Doors



White

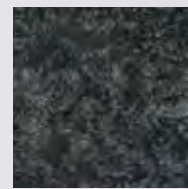

Granite - Dark Grey

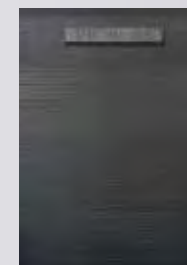

Wenge



Gloss White

Warm White

Warm white LED's emit a yellow glow (similar to that of halogen) and complement a traditional style kitchen featuring wood surfaces and muted worktops perfectly.

Cool White

Cool white LED's are more suited to contemporary/modern kitchen styles. Gives a more modern effect, bouncing off gloss or contemporary surfaces to create a stunning effect.

The general rule of thumb is; for contemporary kitchen designs, opt for cool white LED and for traditional kitchen designs opt for warm white LED. However, it is important that you consider the worktop when selecting your under cabinet lighting. Use the guide above to ensure you choose the best LED colour for your designs every time.

Discover the entire Sensio range online.

The Sensio website has been designed to aid anyone who aspires to introduce a lighting scheme into their kitchen, bedroom or bathroom.

Find everything you need on the Sensio website, quickly and easily. Our lighting is categorised by location or simply enter the Sensio code or product name into the search bar if you are looking for a specific product.

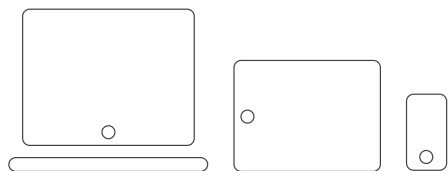

Desktop • Tablet • Mobile
www.sensio.co.uk

What's on there?

- Product information
- Lifestyle shots of all Sensio products
- White shots of all Sensio products
- Installation sheets
- Technical information
- FAQ's
- Video's
- Barcodes

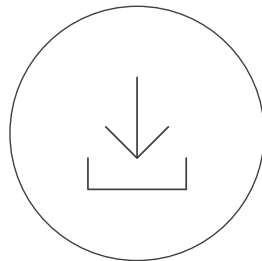

Downloadable Content.

- **Sensio literature**
- **Training material**

Our lighting guide features all of the information you need to design the perfect lighting scheme for your kitchen or bedroom.

- Progress orders and manage your account
- Access to exclusive online discount codes

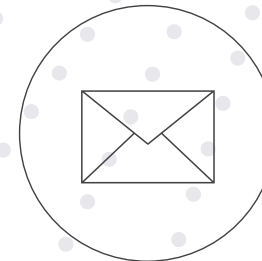

Subscribe to our Newsletter!

Keep up to date with the latest news from us.



Order Online

Key features:

- Place orders online quickly and easily
- Check product availability
- Download additional information/resources

Software

We know how important it is for you to show your customers exactly how their kitchen design will look in the initial stages. Adding a stunning lighting scheme to your plans may just give you the edge and provide the additional 'WOW factor' your customer is looking for. That's why we've made it as easy as possible for you by ensuring the entire Sensio product portfolio is available on the leading kitchen design software.



sensio[®] LIGHTING SPECIFICATION MODULE

Image taken from 2020 showing Sensio warm white LED flexible strip along the plinth and LED lighting in the glass fronted unit. All lighting used is from the Sensio catalogue.

Our product catalogue is available on all the leading kitchen design and online ordering software platforms...

2020

www.2020spaces.com

A quick and simple system with which you can plan and specify a truly representative full lighting plan into your kitchen designs. This means your customer can get a real feel for how their kitchen will look with the exact lighting they will receive included.

- > Select lighting by location as the products are laid out in the Sensio catalogue.
- > The lighting models are a true representation of the actual products – lumen values, beam angles, kelvins and dimensions have all been taken into consideration when the models were produced.
- > Create a quote for the lighting specified in 20-20 Technologies directly, alternatively link to KBB Connect to create your quote with no need to re-input the information.

KBBConnect
KBBSmart

www.smart-systems.co.uk

Easily quote and order Sensio items. The Sensio listing has been designed to save you time, with all the information you need in one place. We've thoroughly thought out the information and layout of the information on KBB Connect and spent a lot of time in perfecting the system to make it as simple and effective to use as possible.

- > In-situ photographs of all products so your customers can fully appreciate how the fitting will look when in place.
- > Products are broken down by kitchen location, making it even easier to choose the required lighting options.
- > We've added a pop-up feature for all items which require a driver/cabbling to run, so it's clear and simple to select the correct driver/cable before ordering.

Compusoft
more faster easier

www.compusoftgroup.com

The Sensio catalogue is available to users of the Winner Design software (Compusoft GB Ltd). A quick and simple, yet effective piece of software which makes it simple to specify the required lighting for your designs.

- > Generic product models, however the full Sensio catalogue is available and the Sensio codes are added to your design in the area's specified.
- > The cost of the lighting is added to the customer quotation for all lighting specified. Following confirmation of the quotation you are able to send an email directly to your supplier of Sensio products, to save you time.
- > Calculate your profit margin via the Winner software.

Become a Sensio Approved Retail Partner.

The ARP is a partnership between Sensio and selected retailers. After extensive research with you, the retailer, we were made aware of how little support there was in the industry to help retailers sell kitchen lighting to customers.

We know you know how integral lighting truly is to a kitchen design; it is the finishing touch that really can create the WOW factor. However, specifying the right lighting for your kitchen designs is key.

We want to help – let us make selling lighting quicker and easier for you and ensure you have the knowledge to specify the perfect lighting scheme for each of your kitchen designs.

Approved
Partner

sensio[®]
furniture lighting solutions

Why should you become a member?

Have the edge over your competitors; if you want to offer an extra, bespoke service to your customers then the ARP is for you. Retailers who are part of the programme will receive a host of benefits including:

- **FREE** showroom lighting planning – let a member of our experienced team plan the lighting schemes for your showroom displays
- Product training
- Access to a dedicated Sensio lighting consultant
- A **FREE** listing in the 'Find a dealer' section of the Sensio website
- **FREE** point-of-sale material to be displayed in your showroom
- Exclusive approved Sensio partner door decal
- **FREE** consumer friendly catalogues for use in the showroom
- Monthly updates from us – stay up-to-date with the latest news, hottest trends and new arrivals direct to your inbox
- Optional online training scheme



How do I become an Approved Retail Partner?

Apply online:



www.sensio.co.uk/arp

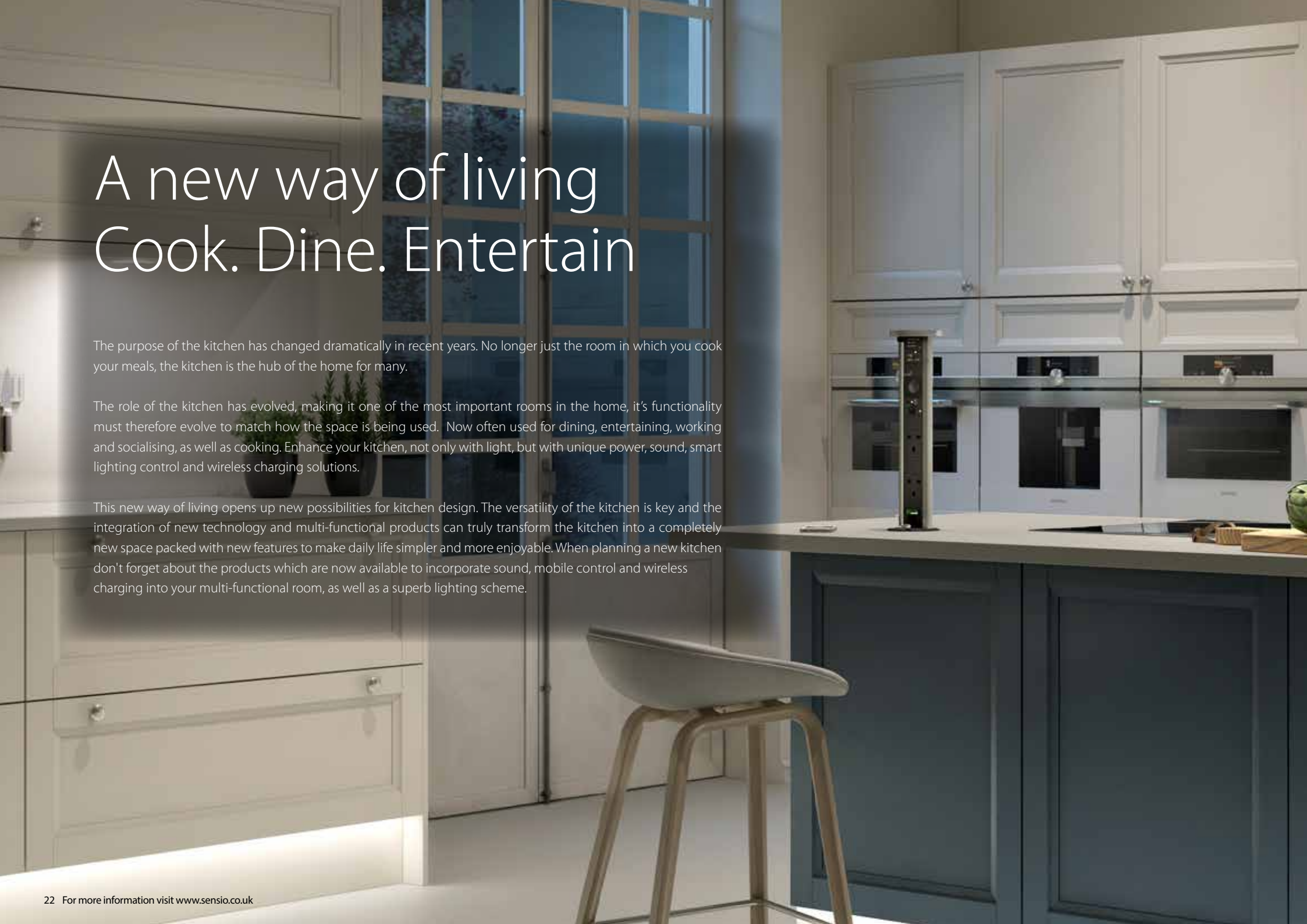

A new way of living Cook. Dine. Entertain

The purpose of the kitchen has changed dramatically in recent years. No longer just the room in which you cook your meals, the kitchen is the hub of the home for many.

The role of the kitchen has evolved, making it one of the most important rooms in the home, it's functionality must therefore evolve to match how the space is being used. Now often used for dining, entertaining, working and socialising, as well as cooking. Enhance your kitchen, not only with light, but with unique power, sound, smart lighting control and wireless charging solutions.

This new way of living opens up new possibilities for kitchen design. The versatility of the kitchen is key and the integration of new technology and multi-functional products can truly transform the kitchen into a completely new space packed with new features to make daily life simpler and more enjoyable. When planning a new kitchen don't forget about the products which are now available to incorporate sound, mobile control and wireless charging into your multi-functional room, as well as a superb lighting scheme.



Task Lighting

Understanding the lighting needs of the kitchen as a working space is crucial when planning a lighting scheme. Ask your customers how they envisage using the space and where and when they will need specific light sources.

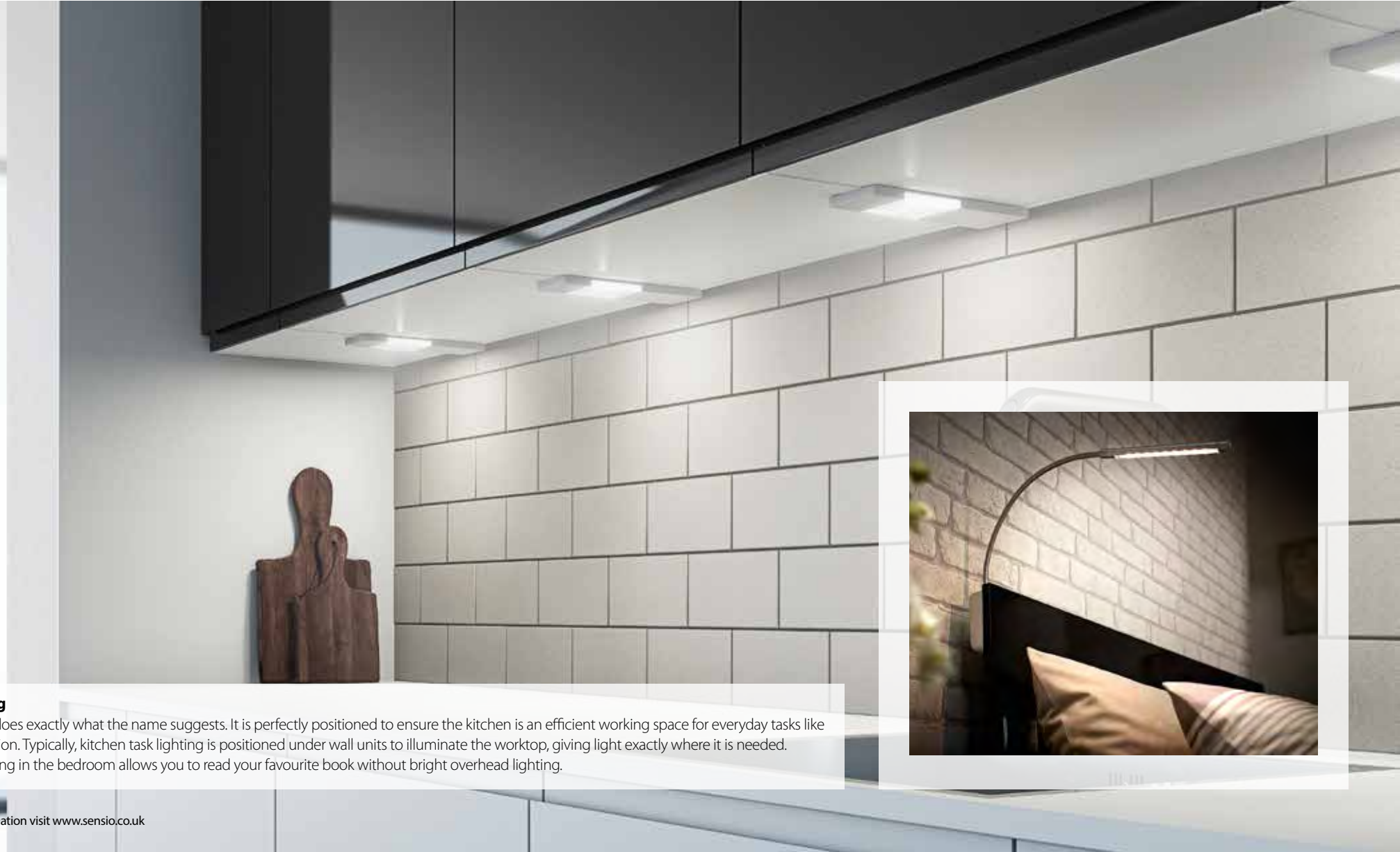

Task Lighting

Task lighting does exactly what the name suggests. It is perfectly positioned to ensure the kitchen is an efficient working space for everyday tasks like food preparation. Typically, kitchen task lighting is positioned under wall units to illuminate the worktop, giving light exactly where it is needed. Reading lighting in the bedroom allows you to read your favourite book without bright overhead lighting.

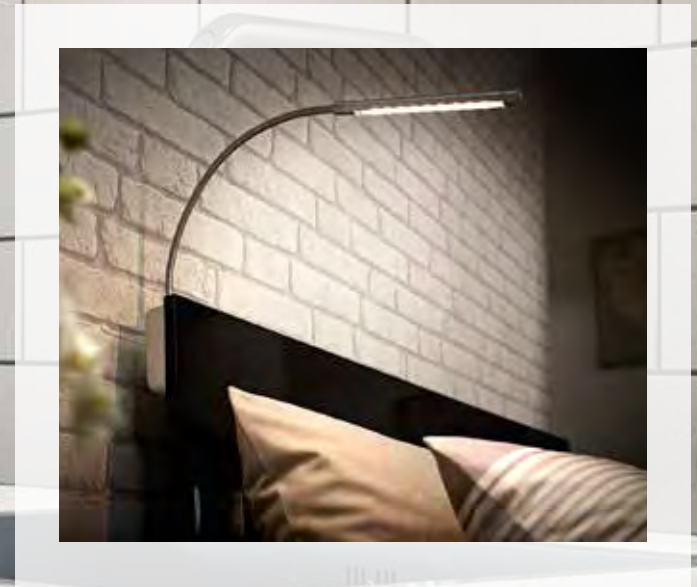

Mood Lighting

The key to achieving a lighting scheme that meets your customers' aesthetic aims as well as their practical needs is in understanding how they will use the space. Often, the kitchen is used as a social space as well as a practical one, so the integration of mood lighting provides an additional depth to the room and a change in atmosphere when required.



Mood Lighting

Mood lighting is used to add dimension and depth to the room in order to create atmosphere and ambience. Consider lighting along the plinth, uplighting above wall units, lighting beneath breakfast bars or on the underside of a worktop and lighting the internal of glass fronted cabinets. Often the most overlooked aspect of a lighting scheme, Mood Lighting really does have the biggest impact!

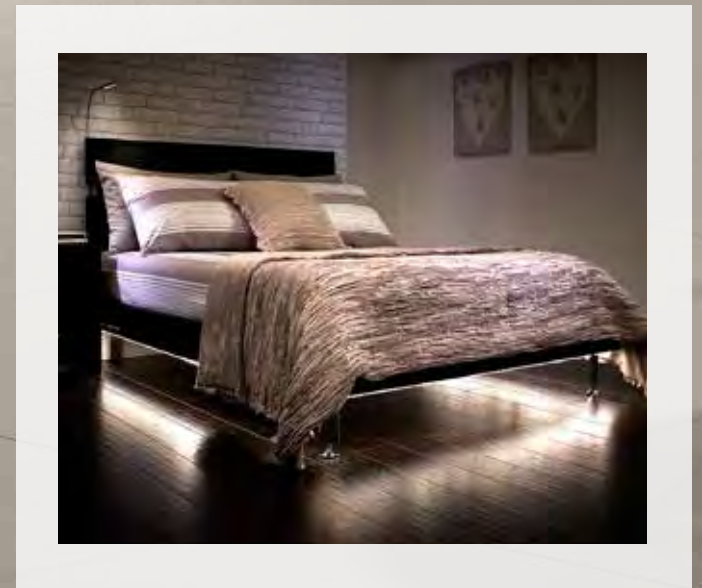

Convenience Lighting

innovate.
create.
illuminate.™



Convenience Lighting

Convenience lighting illuminates cupboards, wardrobes and drawers when opened, for ultimate ease of use. A beautiful added extra which brings a level of luxury to any kitchen or bedroom design.

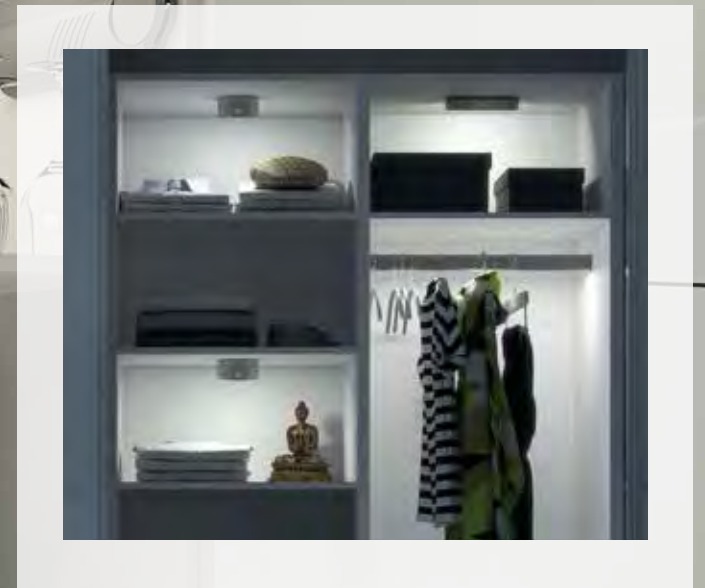

Point of Sale

As part of our commitment to helping the retailer, we offer a POS lighting display unit to help you to communicate our product offer and to help ensure your customer chooses the right lighting solution for their new kitchen.



The point of sale lighting board is the perfect solution to demonstrate different lighting options to your clients.

Featuring the latest in LED technology with a range of spot lights, strip lights and lighting control, inspire your customer with Sensio Lighting products.

Order yours today...

Product code: **POSBOARD**

For pricing please contact your Sensio Area Business Manager.

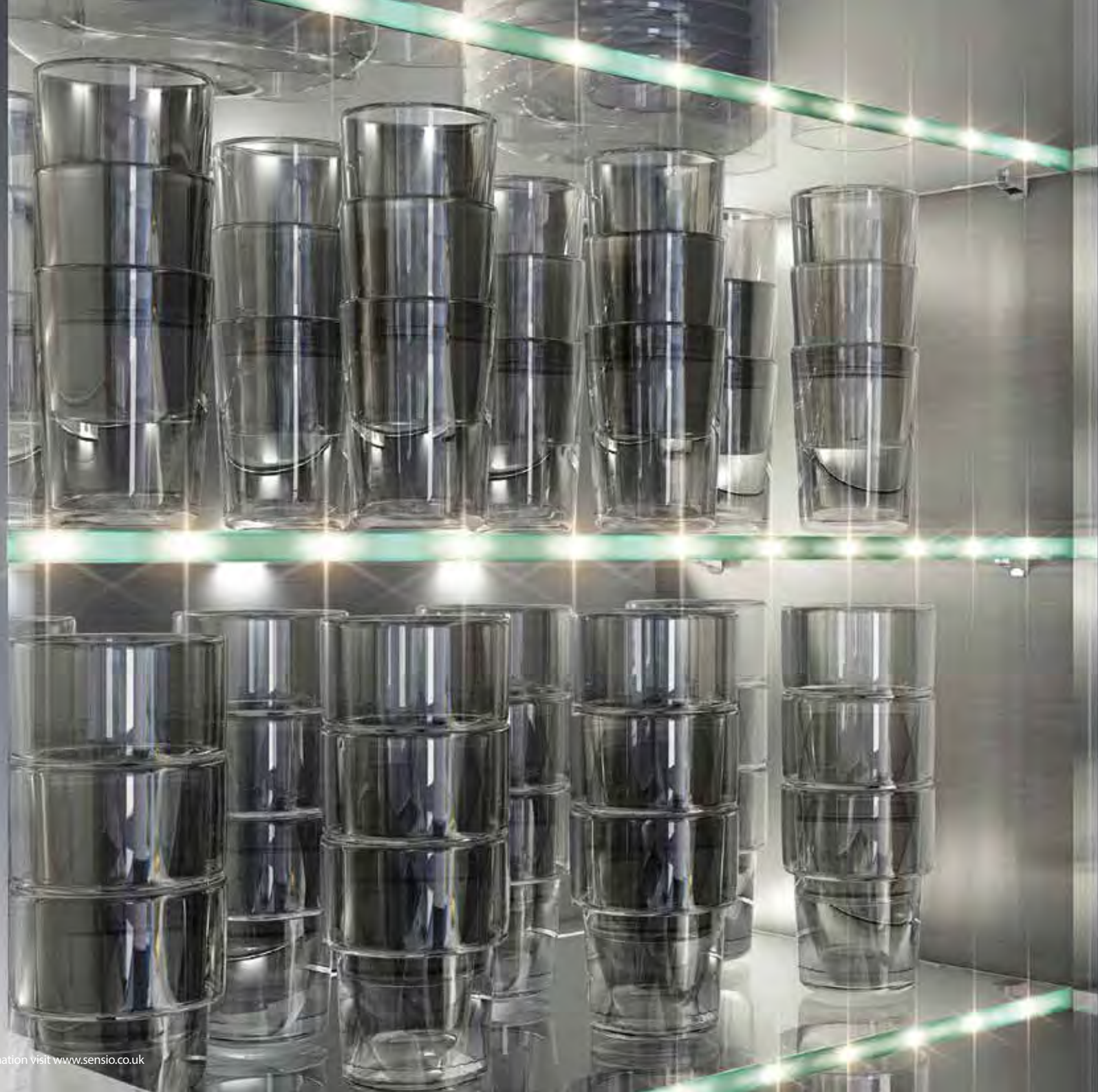

Sensio products
for every area of
your kitchen...

- 30** Under Cabinet Spot Lighting
- 53** Under Cabinet Strip Lighting
- 58** In Cabinet Lighting
- 64** Shelf Lighting
- 68** Drawer Lighting
- 71** Over Cabinet Lighting
- 74** Plinth Lighting
- 82** Flexible Strip Lighting
- 92** Integrated Solutions
- 96** Sensio Midway Hanging Rail
- 100** Fire Rated Ceiling Lighting
- 102** Wireless Charging
- 104** Sensiopod
- 132** Lighting Control
- 143** Drivers

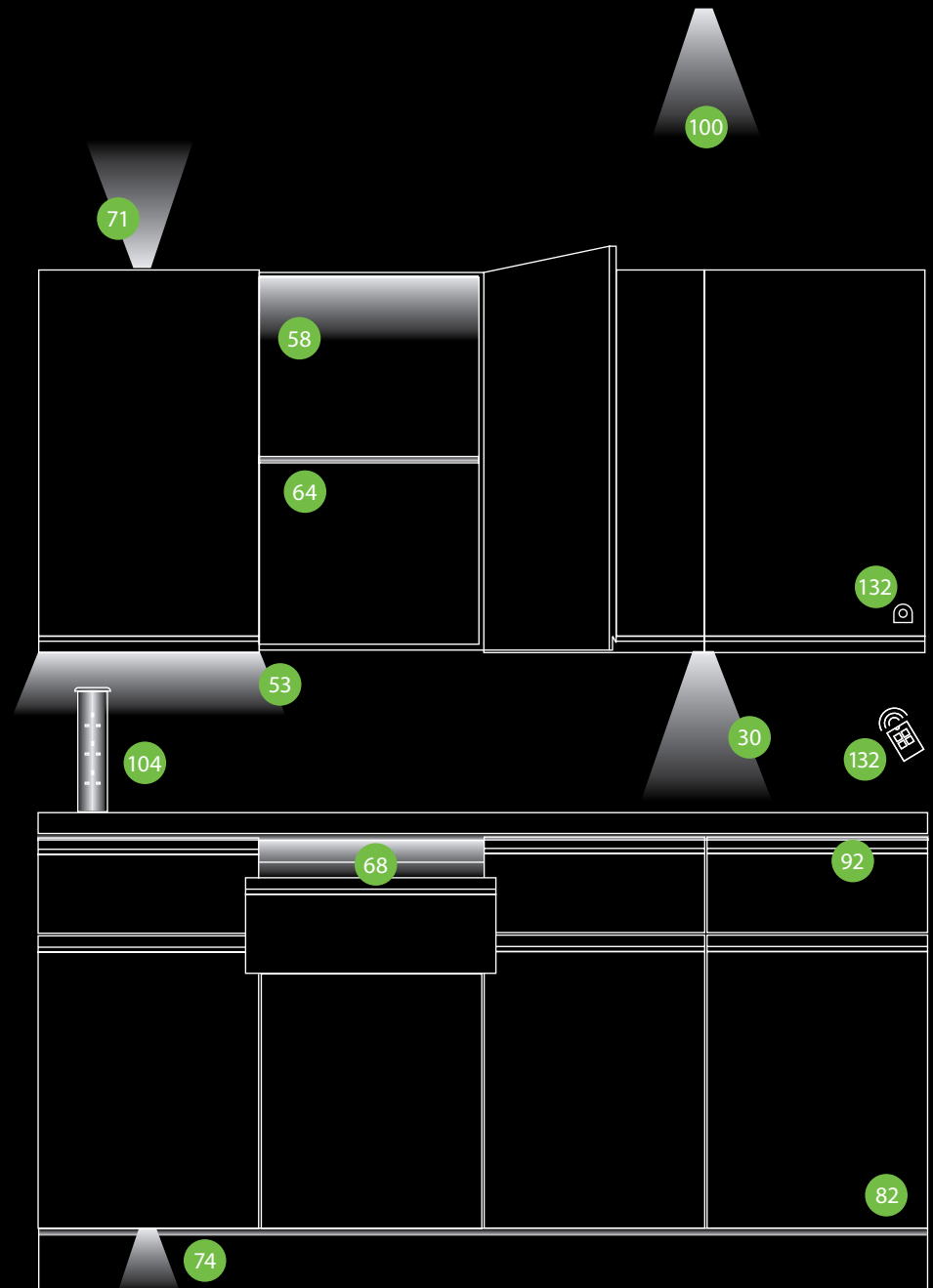

Look out for our latest
products - marked by
this symbol

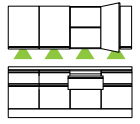

Under Cabinet Spot Lighting >



Under Cabinet Spot Lighting >

SensioSound LED Bluetooth Speaker Light

FINISH:
stainless steel

LED COLOUR:
cool warm

DRIVER:
12V

LAMP LIFE:
13 years

RECOMMENDED LOCATION:

BEAM ANGLE:
120°

'kitchen lighting you can play your music through'

- > High output LED light with built-in Bluetooth RF audio speaker. Wirelessly connect your mobile device with the SensioSound to play your music through the product.
- > One device provides task lighting and allows you to play your music, perfect for when you're cooking or entertaining. Keep your kitchen surfaces tidy from external devices used to play music through.
- > Has the highest light output of any current Sensio under cabinet spotlight. Diffused LED points for a streamlined look.
- > Two of these fittings can be used in sync with one another to fill the room with music.
- > Quick and extremely simple to use, all you need is a SensioSound fitting, 12V driver and a mobile device with Bluetooth. No receivers, wireless boxes or additional wiring required.
- > Operational range of up to 10m.
- > Simple to install via surface mounted fixing with a steel effect finish.



Code	Wattage	LED Colour	Lumen's	Cable	Driver	RRP
SE21090C0	8W	Cool White (5000K)	334 lm	1.8m	■	£84.60
SE21090W0	8W	Warm White (3000K)	228 lm	1.8m	■	£84.60

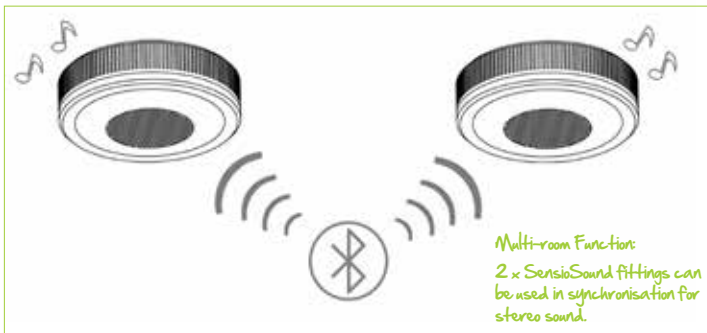

Search for 'SensioSound' via your Bluetooth device. Connect.



Once connected, select the music you'd like to play - whether it be music stored on your mobile device, music via the internet or radio.

Titon

COB LED Triangle Light

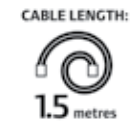
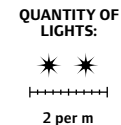
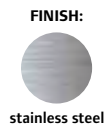

'COB LED in the ever popular triangle housing'

- > Guaranteed to provide the highest luminous efficacy when compared to other like-for-like products currently on the market*
- > COB LED is a unique configuration of closely compacted LED's. It provides enhanced efficiency, a higher light output and a more uniform appearance.
- > This fitting has a maximum luminous efficacy of 95 lm/W.
- > Stainless Steel fitting available with either cool white or warm white LED, great for both contemporary and traditional kitchens.
- > Despite the high output of this fitting, a low wattage of 3W is maintained.
- > IP43 rated - suitable for use close to a sink (protected against direct sprays or splashes of water).
- > Choose the triangle fitting to angle the light towards the front of the worktop.
- > Switch/dim using Sensio sensors and controllers.

* Correct at the time of print



Code	Wattage	LED Colour	Qty	Lumen's	Driver	RRP
SE21390C0	3W	Cool White (5000K)	1	285 lm	■	£22.56
SE21390C2	6W	Cool White (5000K)	2	285 lm	6W included	£60.48
SE21390C3	9W	Cool White (5000K)	3	285 lm	15W included	£89.52
SE21390W0	3W	Warm White (3000K)	1	270 lm	■	£22.56
SE21390W2	6W	Warm White (3000K)	2	270 lm	6W included	£60.48
SE21390W3	9W	Warm White (3000K)	3	270 lm	15W included	£89.52

Accessories		
Code	Description	RRP
SE9009	2.5m Extension Cable	£2.16

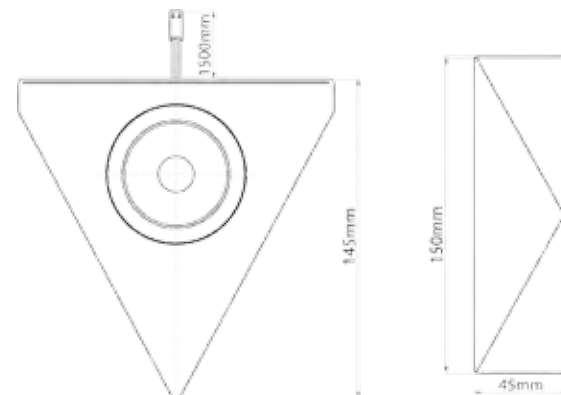

Under Cabinet Spot Lighting >

SLS Bermuda LED Triangle Light

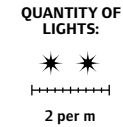

'the popular Bermuda with diffused LED's'

- > The LED's are diffused by a frosted cover making for a more aesthetically pleasing fitting, whilst retaining a high light output.
- > This fitting has a luminous efficacy of 61 lm/W, making it almost 10% brighter than others on the market*.
- > Stainless Steel fitting available with either cool white or warm white LED, great for both contemporary and traditional kitchens.
- > The style of the fitting makes it a direct replacement for a halogen under cabinet triangle light. Purchase in warm white LED for a very similar colour representation also.
- > Long lamp life - lasts up to 17 years more than halogen.
- > Over 90% less energy used when comparing to halogen. Save money on electricity bills when switching from halogen.
- > Switch/dim using Sensio sensors and controllers.

* Correct at the time of print



Code	Wattage	LED Colour	Qty	Lumens	Driver	RRP
SE21000C0	1.65W	Cool White (5000K)	1	100 lm	■	£18.72
SE21000C2	3.3W	Cool White (5000K)	2	100 lm	6W included	£52.68
SE21000C3	4.95W	Cool White (5000K)	3	100 lm	6W included	£72.96
SE21000W0	1.65W	Warm White (3000K)	1	93 lm	■	£18.72
SE21000W2	3.3W	Warm White (3000K)	2	93 lm	6W included	£52.68
SE21000W3	4.95W	Warm White (3000K)	3	93 lm	6W included	£72.96

Accessories

Code	Description	RRP
SE9009	2.5m Extension Cable	£2.16

Diffused LED's



SLS
surface light source

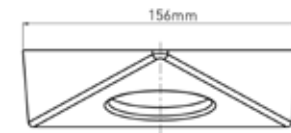
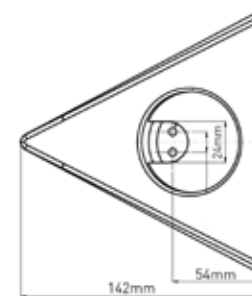

Complete with the Sensio cable connect system

Bermuda HD LED Triangle Light

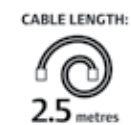
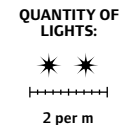
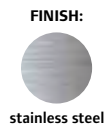

'traditional look, modern solution'

- > Stainless Steel fitting available with either cool white or warm white LED, great for both contemporary and traditional kitchens.
- > High Definition LED, each diode has a lens over it to intensify the light output.
- > This fitting has a luminous efficacy of 80 lm/W, making it almost 30% brighter than equivalent products on the market*.
- > The style of the fitting makes it a direct replacement for a halogen under cabinet triangle light. Purchase in warm white LED for a very similar colour representation also.
- > Long lamp life - lasts up to 17 years more than halogen.
- > Over 90% less energy used when comparing to halogen. Save money on electricity bills when switching from halogen to HD LED.
- > Compatible with Sensio sensors and controllers.

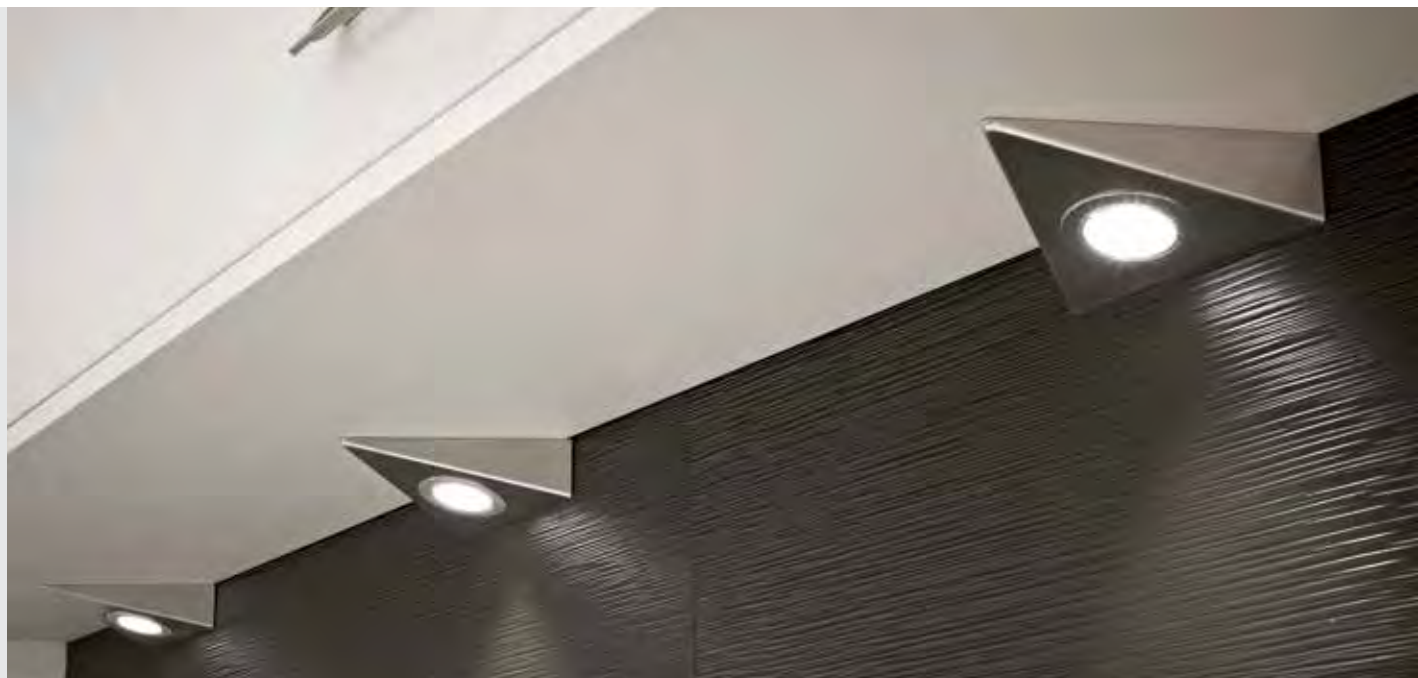

Code	Wattage	LED Colour	Qty	Lumens	Driver	RRP
SE9001HDSSCW	1.65W	Cool White (5000K)	1	132 lm	■	£18.72
SE9001HDSSCWK2	3.3W	Cool White (5000K)	2	132 lm	6W included	£57.24
SE9001HDSSCWK3	4.95W	Cool White (5000K)	3	132 lm	6W included	£75.60
SE9001HDSSWW	1.65W	Warm White (3000K)	1	123 lm	■	£18.72
SE9001HDSSWWK2	3.3W	Warm White (3000K)	2	123 lm	6W included	£57.24
SE9001HDSSWWK3	4.95W	Warm White (3000K)	3	123 lm	6W included	£75.60

Accessories

Code	Description	RRP
SE9009	2.5m Extension Cable	£2.16

Cool White LED



Warm White LED

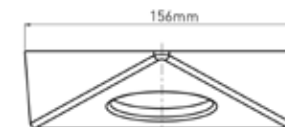
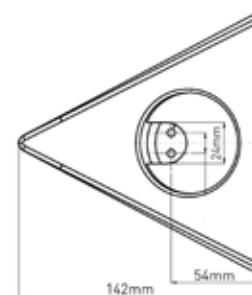

Complete with the Sensio cable connect system

Under Cabinet Spot Lighting >

Novus HD LED Triangle Light

FINISH:
aluminium

LED COLOUR:
cool warm

LAMP LIFE:
18.5
years

DRIVER:
24V

QUANTITY OF LIGHTS:
2 per m

CABLE LENGTH:
2.5 metres

DIMMABLE:

BEAM ANGLE:
50°

'slim exterior, high brightness'

- > Slim profile design. Perfect for contemporary kitchens without a pelmet.
- > This fitting has a luminous efficacy of 80 lm/W, making it almost 30% brighter than equivalent products on the market*.
- > The sensor version has an integrated IR sensor, swipe your hand past the sensor to illuminate the fitting and connected lights.
- > Two non-sensor fittings can be connected to the sensor version via ports on the back of the fitting.
- > Sensor illuminates red to ensure visibility if the kitchen is dark.
- > By using an IR swipe sensor with task lighting in the kitchen, hygiene levels are maintained when preparing food etc.
- > High definition LED - each diode has a lens over it to intensify the light output.
- > Available in both cool white and warm white LED to suit a variety of kitchen designs.



	Code	Wattage	LED Colour	Qty	Lumens	Driver	RRP
Non-sensor	SE9001HDCW	1.65W	Cool White (5000K)	1	132 lm	■	£24.84
	SE9001HDCWK2	3.3W	Cool White (5000K)	2	132 lm	6W included	£70.80
	SE9001HDCWK3	4.95W	Cool White (5000K)	3	132 lm	6W included	£95.88
	SE9001HDWW	1.65W	Warm White (3000K)	1	123 lm	■	£24.84
	SE9001HDWWK2	3.3W	Warm White (3000K)	2	123 lm	6W included	£70.80
	SE9001HDWWK3	4.95W	Warm White (3000K)	3	123 lm	6W included	£95.88
Sensor	SE9001HDSCW	2.15W	Cool White (5000K)	1	132 lm	■	£35.76
	SE9001HDSCWK2	3.8W	Cool White (5000K)	2	132 lm	6W included	£81.72
	SE9001HDSCWK3	5.45W	Cool White (5000K)	3	132 lm	6W included	£106.68
	SE9001HDSWW	2.15W	Warm White (3000K)	1	123 lm	■	£35.76
	SE9001HDSWWK2	3.8W	Warm White (3000K)	2	123 lm	6W included	£81.72
	SE9001HDSWWK3	5.45W	Warm White (3000K)	3	123 lm	6W included	£106.68

Non-sensor



Sensor



Two non-sensor fittings can be connected to the sensor version via ports on the back of the fitting and all 3 lights controlled via the one sensor.

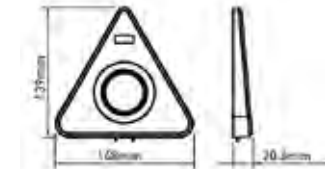
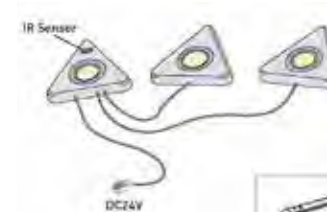

Complete with the Sensio cable connect system



Swipe your hand within 5cm of the IR sensor to switch the lights on/off

Accessories

Code	Description	RRP
SE9009	2.5m Extension Cable	£2.16

Under Cabinet Spot Lighting >

GX53 Trigon LED Triangle Light

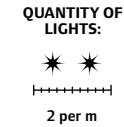
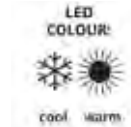

'no LED driver required'

- > Stainless steel triangle light fitting only.
- > Buy the fitting and then choose your LED lamp from the table below.
- > This fitting runs at 240V so no driver is required. Connect directly to the mains.
- > Choose from cool white or warm white high power, energy efficient GX53 LED lamps.
- > Extremely simple connection system, the mains cable has a connector attached which plugs into the SE11175 (see accessories below). When this accessory is used these fittings can be installed by anyone.
- > 50 diodes integrated for optimum light output.
- > The angled aspect of a triangle light fitting means the light is directed forward onto the worktop.
- > The lamps are simple to replace via a simple twist and lock mechanism.



1 Order your GX53 triangle light fitting

Code	Finish	Connection	RRP
SE11147SS	Stainless Steel	240V	£11.52

2 Choose your GX53 lamp

Code	Wattage	LED Colour	LED Qty	Lumens	Connection	RRP
SE10156CW	3W	Cool White (5800K)	50	250 lm	240V	£19.20
SE10156WW	3W	Warm White (3000K)	50	245 lm	240V	£22.68

3 Do you require GX53 accessories?

SE11172	GX53 2m extension cable	£3.48
SE11175	GX53 6 way distributor block with 1.5m cable & plug	£11.28

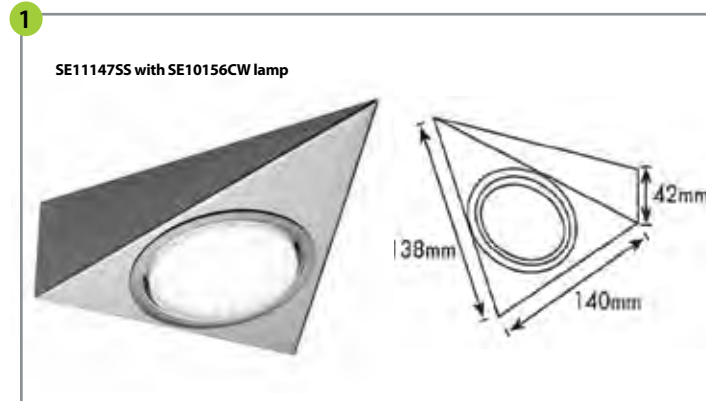

2 SE10156 - GX53 LED Lamp



3 SE11172 - GX53 2m extension cable



Venus

COB LED Recess/Surface Light

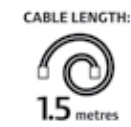
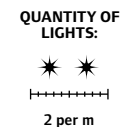
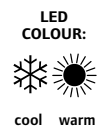

'COB LED - the latest LED technology'

- > Guaranteed to provide the highest luminous efficacy when compared to other like-for-like products currently on the market*
- > COB LED is a unique configuration of closely compacted LED's. It provides enhanced efficiency, a higher light output and a more uniform appearance.
- > The fitting is supplied with the collar. Can be either surface or recess mounted.
- > This fitting has a maximum luminous efficacy of 95 lm/W.
- > Stainless Steel fitting available with either cool white or warm white LED, great for both contemporary and traditional kitchens.
- > Despite the high output of this fitting, a low wattage of 3W is maintained.
- > IP43 rated - suitable for use close to a sink (protected against direct sprays or splashes of water).
- > Switch/dim using Sensio sensors and controllers.

* Correct at the time of print



Code	Wattage	LED Colour	Qty	Lumen's	Driver	RRP
SE21290C0	3W	Cool White (5000K)	1	285 lm	■	£20.64
SE21290C2	6W	Cool White (5000K)	2	285 lm	6W included	£56.64
SE21290C3	9W	Cool White (5000K)	3	285 lm	15W included	£83.76
SE21290W0	3W	Warm White (3000K)	1	270 lm	■	£20.64
SE21290W2	6W	Warm White (3000K)	2	270 lm	6W included	£56.64
SE21290W3	9W	Warm White (3000K)	3	270 lm	15W included	£83.76

Accessories		
Code	Description	RRP
SE9009	2.5m Extension Cable	£2.16

Surface Mounted



Recessed

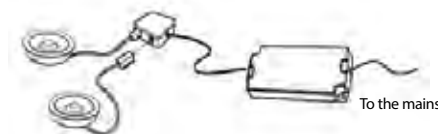
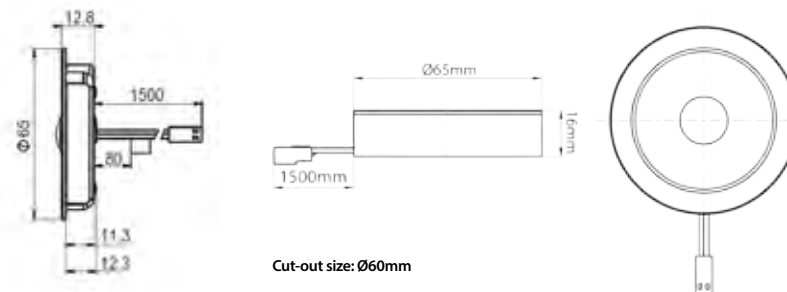

Under Cabinet Spot Lighting >

SLS Lara Surface/Recessed Light

FINISH:
aluminium

LED COLOUR:
cool warm

LAMP LIFE:
13
years

DRIVER:
24V

QUANTITY OF LIGHTS:
2 per m

DIMMABLE:

BEAM ANGLE:
105°

'high quality, high output'

- > Surface Light Source (SLS) products are LED fittings with no visible LED points.
- > This fitting has a luminous efficacy of 72 lm/W, making it over 35% brighter than others on the market*.
- > The sleekest and brightest of all of the current Sensio SLS LED under cabinet spot lights.
- > Available in both cool white and warm white LED, choose the option which will work best with the work surface and kitchen style.
- > Use as task lighting under cabinets or to illuminate cabinet interiors in glass fronted wall units.
- > Spacer included, fitting can be surface mounted or recessed.
- > Long lamp life - lasts up to 11.5 years more than halogen.
- > Switch from halogen and see significant savings on your energy bills.
- > Why this SLS spot light? The aluminium of this fitting has good thermal conduction, which in turn creates over double the light output than a steel SLS fitting.

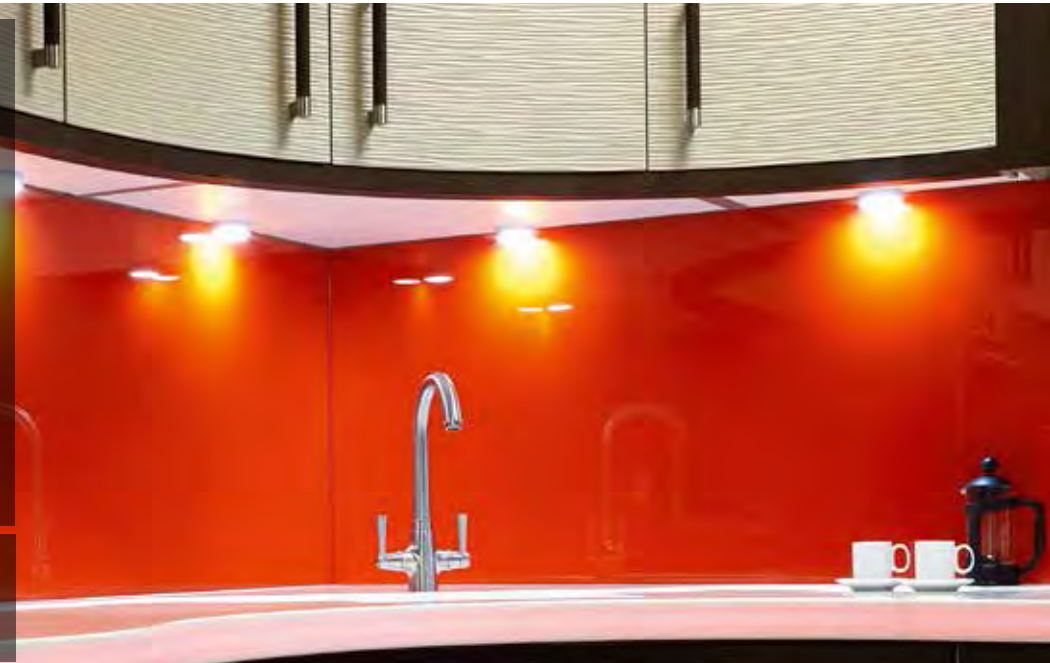

Code	Wattage	LED Colour	Qty	Lumens	Cable	Driver	RRP
SE10166C0	3W	Cool White (5000K)	1	216 lm	1.5m	■	£24.12
SE10166C2	6W	Cool White (5000K)	2	216 lm	1.5m	6W included	£65.40
SE10166C3	9W	Cool White (5000K)	3	216 lm	1.5m	15W included	£95.52
SE10166W0	3W	Warm White (3000K)	1	194 lm	1.5m	■	£24.12
SE10166W2	6W	Warm White (3000K)	2	194 lm	1.5m	6W included	£65.40
SE10166W3	9W	Warm White (3000K)	3	194 lm	1.5m	15W included	£95.52

Accessories		
Code	Description	RRP
SE9009	2.5m Extension Cable	£2.16

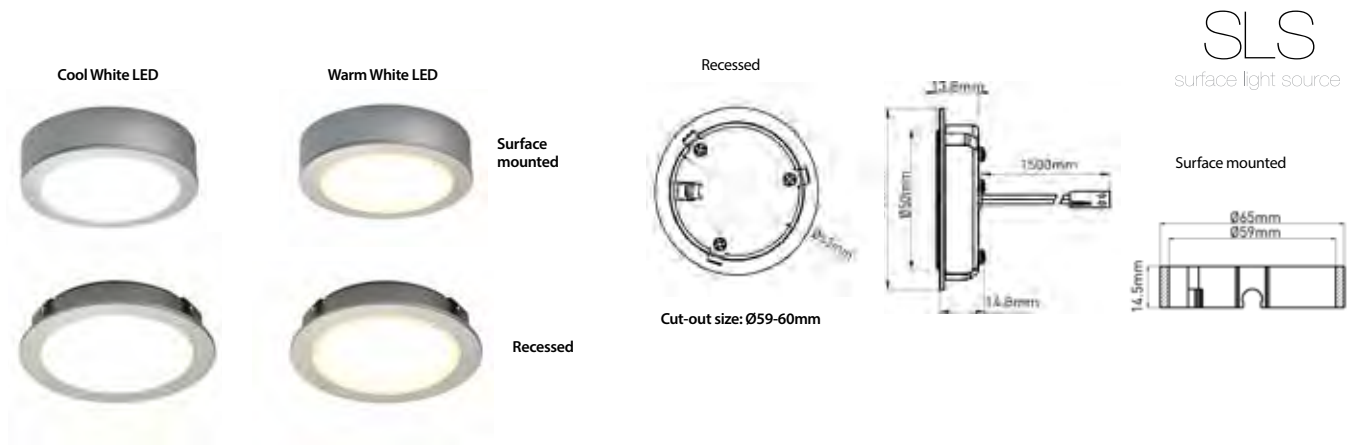

Under Cabinet Spot Lighting >

SLS Hype LED Recess/Surface Light

FINISH:  stainless steel	LED COLOUR:  cool warm	LAMP LIFE:  18.5 years	DRIVER:  24V	QUANTITY OF LIGHTS:  2 per m	CABLE LENGTH:  2.5 metres	DIMMABLE: 	BEAM ANGLE:  105°
--	---	--	--	--	---	---	---

'frosted cover for diffused LED's'

- > The fitting is supplied with the collar, can be either surface or recess mounted.
- > Sleek appearance. The LED's are diffused by a frosted cover making for a more aesthetically pleasing fitting, whilst retaining a high light output.
- > This fitting has a luminous efficacy of 61 lm/W, making it almost 10% brighter than others on the market*.
- > Stainless Steel fitting available with either cool white or warm white LED, great for both contemporary and traditional kitchens.
- > The style of the fitting makes it a direct replacement for a halogen under cabinet recess/surface light. Purchase in warm white LED for a very similar colour representation also.
- > Long lamp life - lasts up to 17 years more than halogen.
- > Over 90% less energy used when comparing to halogen. Save money on electricity bills when switching from halogen.



* Correct at the time of print

Code	Wattage	LED Colour	Qty	Lumens	Driver	RRP
SE21100C0	1.65W	Cool White (5000K)	1	100 lm	■	£15.72
SE21100C2	3.3W	Cool White (5000K)	2	100 lm	6W included	£48.12
SE21100C3	4.95W	Cool White (5000K)	3	100 lm	6W included	£65.52
SE21100W0	1.65W	Warm White (3000K)	1	93 lm	■	£15.72
SE21100W2	3.3W	Warm White (3000K)	2	93 lm	6W included	£48.12
SE21100W3	4.95W	Warm White (3000K)	3	93 lm	6W included	£65.52

Accessories		
Code	Description	RRP
SE9009	2.5m Extension Cable	£2.16

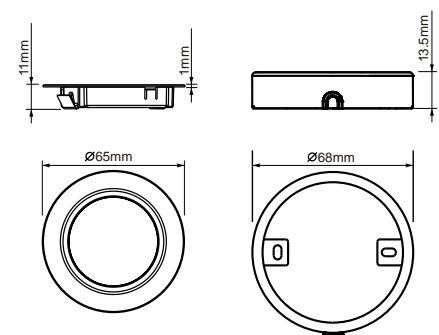

Cut-out size: Ø60mm



Complete with the Sensio cable connect system

SLS
surface light source

Under Cabinet Spot Lighting >

Hype/Argo HD LED Surface Light

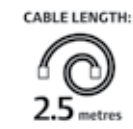
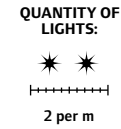
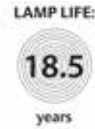

'the classic high output LED surface/recess light'

- > The fitting is supplied with the collar, can be either surface or recess mounted.
- > Steel or aluminium finishes available in cool and warm white LED. Be sure to find the perfect spot light for your kitchen from this popular range.
- > This fitting has a luminous efficiency of 80 lm/W, making it almost 30% brighter than equivalent products on the market*.
- > High definition LED – a lens over each diode intensifies the light output.
- > Use as task lighting under cabinets or to illuminate cabinet interiors in glass fronted wall units.
- > Over 90% less energy used when comparing to halogen. Save money on electricity bills when switching from halogen to HD LED.
- > Long lamp life - lasts up to 17 years more than halogen.
- > Fittings are complete with the Sensio cable connect system.
- > Can be used with the range of Sensio switches and dimmers.
- > Use the SE9009 to extend the cable on each fitting by 2.5m. RRP - £2.16.



Stainless Steel finish

Code	Wattage	LED Colour	Qty	Lumens	Driver	RRP
SE9005HDSSCW	1.65W	Cool White (5000K)	1	132 lm	■	£15.72
SE9005HDSSCWK2	3.3W	Cool White (5000K)	2	132 lm	6W included	£49.68
SE9005HDSSCWK3	4.95W	Cool White (5000K)	3	132lm	6W included	£65.52
SE9005HDSSWW	1.65W	Warm White (3000K)	1	123 lm	■	£15.72
SE9005HDSSWWK2	3.3W	Warm White (3000K)	2	123 lm	6W included	£49.68
SE9005HDSSWWK3	4.95W	Warm White (3000K)	3	123 lm	6W included	£65.52

Aluminium finish

Code	Wattage	LED Colour	Qty	Lumens	Driver	RRP
SE9005HDCW	1.65W	Cool White (5000K)	1	132 lm	■	£21.24
SE9005HDCWK2	3.3W	Cool White (5000K)	2	132 lm	6W included	£61.32
SE9005HDCWK3	4.95W	Cool White (5000K)	3	132lm	6W included	£82.68
SE9005HDWW	1.65W	Warm White (3000K)	1	123 lm	■	£21.24
SE9005HDWWK2	3.3W	Warm White (3000K)	2	123 lm	6W included	£61.32
SE9005HDWWK3	4.95W	Warm White (3000K)	3	123 lm	6W included	£82.68

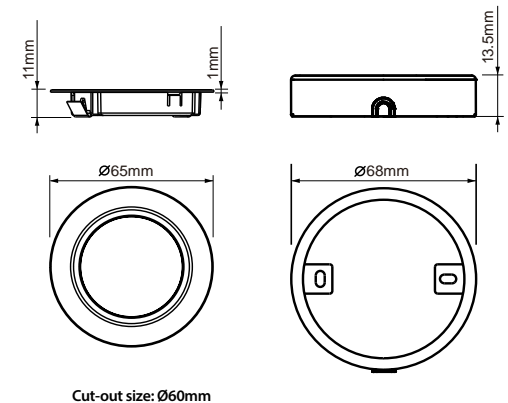

Nico

240V LED Surface/Recessed Light



'anyone can install - our first 240V SLS fitting'

- > Surface Light Source (SLS) products are LED fittings with no visible LED points.
- > This fitting runs at 240V so no driver is required.
- > Extremely simple to install if you use the 6 way distribution block. Simply connect up to 6 of the Nico fittings into the ports on the distributor block and connect this directly to the mains supply (13A plug pre-wired to the SE211570).
- > When using the distribution block anyone can install these fittings - no need for Part P as it is all plug and play.
- > Use as task lighting under cabinets or to illuminate cabinet interiors in glass fronted wall units.
- > Spacer included, fitting can be surface mounted or recessed.
- > Extremely long lamp life. This fitting will more than likely outlive your kitchen.
- > A much smaller and neater fitting than GX53 with a connector small enough to fit through an 8mm hole.



Code	Wattage	LED Colour	Qty	Lumen's	Cable	Voltage	RRP
SE21190C0	3W	Cool White (5000K)	1	180 lm	1.5m	240V	£27.96
SE21190C2	6W	Cool White (5000K)	2	180 lm	1.5m	240V	£70.08
SE21190C3	9W	Cool White (5000K)	3	180 lm	1.5m	240V	£98.16
SE21190W0	3W	Warm White (3000K)	1	170 lm	1.5m	240V	£27.96
SE21190W2	6W	Warm White (3000K)	2	170 lm	1.5m	240V	£70.08
SE21190W3	9W	Warm White (3000K)	3	170 lm	1.5m	240V	£98.16

Accessories		
Code	Description	RRP
SE211570	Nico 6 Way Distribution Block	£13.44
SE211750	Nico 1.5m Extension Cable	£5.16

SLS
surface light source



Cut-out: Ø 59-61mm



SE211750 - Nico
1.5m Extension
Cable



SE211570 - Nico 6
Way Distribution
Block

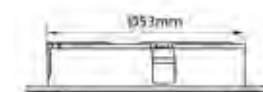
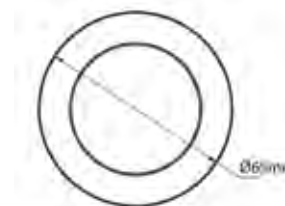

Under Cabinet Spot Lighting >

GX53 Circa LED Recessed/Surface Light

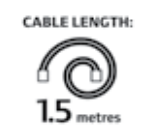
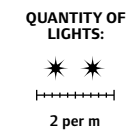
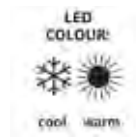

'mains LED spot lighting - anyone can install'

- > The steel fitting can be either surface mounted or recessed.
- > Buy the fitting and then choose your LED lamp from the table below.
- > Choose from two high power, energy efficient GX53 LED lamps, available in both cool white or warm white LED.
- > This fitting runs at 240V so no driver is required. Connect directly to the mains.
- > Extremely simple connection system, the mains cable has a connector attached which plugs into the SE11175 (see accessories below). When this accessory is used these fittings can be installed by anyone as the distribution unit has a 13A plug pre-wired.
- > 50 diodes integrated in the GX53 lamps for optimum light output.
- > The lamps are simple to replace via a simple twist and lock mechanism.



1 Choose your GX53 fitting

Code	Finish	Fitting Type	Connection	RRP
SE11146SS	Stainless Steel	Recess/Surface	240V	£12.72

2 Choose your GX53 lamp

Code	Wattage	LED Colour	LED Qty	Lumens	Connection	RRP
SE10156CW	3W	Cool White (5800K)	50	250 lm	240V	£19.20
SE10156WW	3W	Warm White (3000K)	50	245 lm	240V	£22.68

3 Do you require GX53 accessories?

SE11172	GX53 2m Extension Cable	£3.48
SE11175	GX53 6 Way Distributor Block with 1.5m Cable & Plug	£11.28



2 SE10156 - GX53 LED Lamp

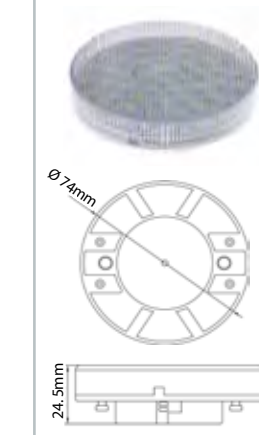

3 SE11172 - GX53 2m extension cable



Orbit Tiltable LED Light

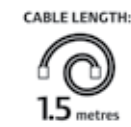
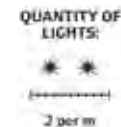

'tiltable, super bright LED spot light'

- > The tiltable centre section of this fitting allows you to direct the light to the position on the worktop or in a cabinet as you require.
- > The fitting is supplied with the collar, can be either surface or recess mounted.
- > 35% - 59% brighter than the SE9005HDWW/CW.
- > This fitting has a luminous efficacy of 59/81 lm/W.
- > High performance LED chips for optimum light output.
- > Available in both cool white and warm white LED to suit a variety of kitchen designs.
- > Use as task lighting under cabinets or to illuminate cabinet interiors.
- > Long lamp life - lasts up to 17 years more than halogen.
- > Can be used with the range of Sensio switches and dimmers.
- > Die cast metal exterior with an aluminium effect finish.



Code	Wattage	LED Colour	Qty	Lumens	Driver	RRP
SE9008HDCW	3W	Cool White (5000K)	1	243 lm	■	£28.08
SE9008HDCWK2	6W	Cool White (5000K)	2	243 lm	6W included	£71.52
SE9008HDCWK3	9W	Cool White (5000K)	3	243 lm	15W included	£105.24
SE9008HDWW	3W	Warm White (3000K)	1	176 lm	■	£28.08
SE9008HDWWK2	6W	Warm White (3000K)	2	176 lm	6W included	£71.52
SE9008HDWWK3	9W	Warm White (3000K)	3	176 lm	15W included	£105.24

Accessories		
Code	Description	RRP
SE9009	2.5m Extension Cable	£2.16

Surface Mounted

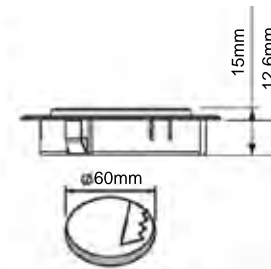

Recessed



Cut-out size: Ø60mm

Under Cabinet Spot Lighting >

LED PAD

Dimmable SLS LED Light

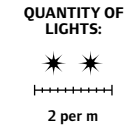

'integrated LED dimming technology'

- > Slimline fitting with a depth of only 10mm.
- > Fittings available with or without integrated sensor. The features of the sensor are;
 - On/Off function: Place hand within 10cm of the IR sensor to switch the light on/off.
 - Dimming function: Place hand within 10cm of the IR sensor and the brightness will alter between 5% and 100%. The lighting level will continue to change until you move your hand, do so when you reach the desired level.
- > Simple to install, these fittings daisy chain together. Link a maximum of 4 non-sensor fittings to a sensor fitting for synchronised switching.
- > Uniform illumination with a wide spread of light from each fitting.
- > Available in both cool white and warm white LED, choose the option which will work best with the work surface and kitchen style.
- > Luminous efficacy of 80-91 lm/W.



	Code	Wattage	LED Colour	Qty	Lumens	Driver	RRP
Non-Sensor	SE21002C0	4W	Cool White (5000K)	1	365 lm	■	£41.04
	SE21002C2	8W	Cool White (5000K)	2	365 lm	15W included	£104.16
	SE21002C3	12W	Cool White (5000K)	3	365 lm	15W included	£145.68
	SE21002W0	4W	Warm White (3000K)	1	320 lm	■	£41.04
	SE21002W2	8W	Warm White (3000K)	2	320 lm	15W included	£104.16
	SE21002W3	12W	Warm White (3000K)	3	320 lm	15W included	£145.68
Sensor	SE21102C0	4W	Cool White (5000K)	1	365 lm	■	£47.04
	SE21102C3	12W	Cool White (5000K)	3	365 lm	15W included	£151.68
	SE21102W0	4W	Warm White (3000K)	1	320 lm	■	£47.04
	SE21102W3	12W	Warm White (3000K)	3	320 lm	15W included	£151.68

Non-Sensor



With Dimming On/Off Sensor

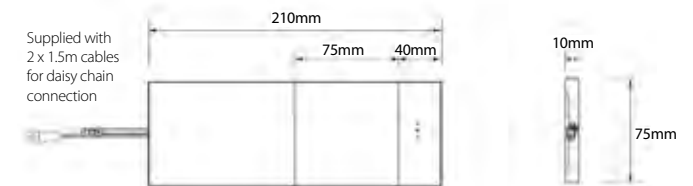

Accessories

Code	Description	RRP
SE9009	2.5m Extension Cable	£2.16

SLS
surface light source

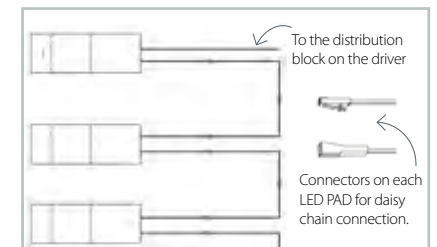

Under Cabinet Spot Lighting >

SLS Quadra

LED Under/Over Cabinet Light

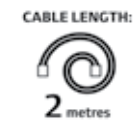
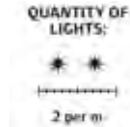

'multi-functional UK product design'

- > An upgrade from the original Quadra under and over cabinet lights. Designed by Sensio in the UK this is a unique product design.
- > Transform this product into an over cabinet light by purchasing a bracket.
- > The specialised lens on this product diffuses the LED's to create the appearance of invisible diodes.
- > Featuring a higher number of LED's than the original Quadra range for an improved light output.
- > The sensor has been upgraded to IR to maintain hygiene levels in the kitchen.
- > The fittings daisy chain together (run 6 from a 15W driver). Daisy chain non-sensor fittings into one sensor fitting for synchronised switching of all lighting in the run via the integrated IR sensor switch.
- > Specially designed mounting brackets for simple installation. The over cabinet bracket slides along the fitting for desired positioning of the light.
- > The new elongated design allows for an increased spread of light across the worktop.



Designed in the UK



	Code	Wattage	LED Colour	Qty	Lumens	Driver	RRP
Non-sensor	SE21092C0	2.5W	Cool White (5600K)	1	170 lm	■	£18.48
	SE21092C2	5W	Cool White (5600K)	2	170 lm	6W included	£52.20
	SE21092C3	7.5W	Cool White (5600K)	3	170 lm	15W included	£74.40
	SE21092W0	2.5W	Warm White (3000K)	1	155 lm	■	£18.48
	SE21092W2	5W	Warm White (3000K)	2	155 lm	6W included	£52.20
	SE21092W3	7.5W	Warm White (3000K)	3	155 lm	15W included	£74.40
Sensor	SE21192C0	2.5W	Cool White (5600K)	1	170 lm	■	£23.88
	SE21192C2	5W	Cool White (5600K)	2	170 lm	6W included	£57.72
	SE21192C3	7.5W	Cool White (5600K)	3	170 lm	15W included	£79.44
	SE21192W0	2.5W	Warm White (3000K)	1	155 lm	■	£23.88
	SE21192W2	5W	Warm White (3000K)	2	155 lm	6W included	£57.72
	SE21192W3	7.5W	Warm White (3000K)	3	155 lm	15W included	£79.44

SLS
surface light source

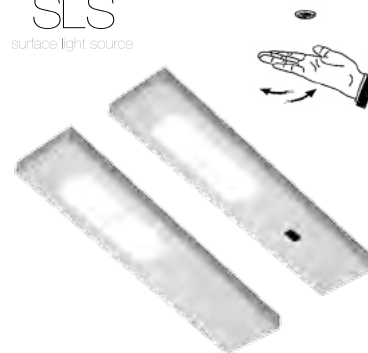

The non-sensor fitting can also be used with the Sensio range of switches and controllers.



Buy the mounting bracket separately to transform the under cabinet light (without sensor) into an over cabinet light.

SE240920 - Mounting Bracket for Quadra SLS - £1.08

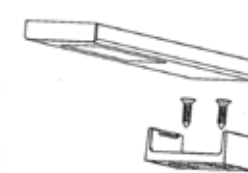

Over cabinet mounting (each bracket to be bought separately)

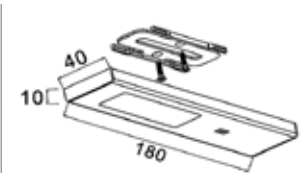

Under cabinet mounting (bracket provided with each fitting).

Optional accessories

- Over Cabinet Mounting Bracket (SE240920) - £1.08
- Aluminium Cable Channel (SE7003AL) - £3.84
- 2.5m Extension Cable (SE9009) - £2.16

Under Cabinet Spot Lighting >

Quadra PLUS - U LED Under Cabinet Light

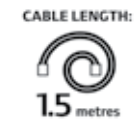
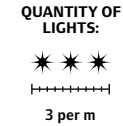

'the original slimline LED under cabinet light'

- > The lens on this fitting has a triphosphor coating, creating an even spread of light.
- > Available in both cool white and warm white LED, allowing you to select the light colour which is best suited to the design of your kitchen.
- > The fittings daisy chain together meaning a maximum of 6 fittings can be run from 1 x 15W driver (6 fittings if connected individually).
- > Daisy chain non-sensor fittings into one sensor fitting for synchronised switching of all lighting in the run via the integrated touch sensor.
- > The touch sensor illuminates blue when the light is off for visibility.
- > Slimline, discreet fitting.
- > The aluminium finish and design of this fitting makes it ideal for use in contemporary kitchens.



	Code	Wattage	LED Colour	Qty	Lumens	Driver	RRP
Non-sensor	01.1000.0610	2.4W	Cool White (5670K)	1	113 lm	■	£18.48
	01.1000.0612	4.8W	Cool White (5670K)	2	113 lm	6W included	£52.20
	01.1000.0613	7.2W	Cool White (5670K)	3	113 lm	15W included	£71.16
	01.1000.0620	2.4W	Warm White (3000K)	1	113 lm	■	£18.48
	01.1000.0622	4.8W	Warm White (3000K)	2	113 lm	6W included	£52.20
	01.1000.0623	7.2W	Warm White (3000K)	3	113 lm	15W included	£71.16
Sensor	01.1001.0610	2.5W	Cool White (5670K)	1	113 lm	■	£24.48
	01.1001.0612	5W	Cool White (5670K)	2	113 lm	6W included	£60.12
	01.1001.0613	7.5W	Cool White (5670K)	3	113 lm	15W included	£80.04
	01.1001.0620	2.5W	Warm White (3000K)	1	113 lm	■	£24.48
	01.1001.0622	5W	Warm White (3000K)	2	113 lm	6W included	£60.12
	01.1001.0623	7.5W	Warm White (3000K)	3	113 lm	15W included	£80.04

Without Touch Sensor



With Touch Sensor

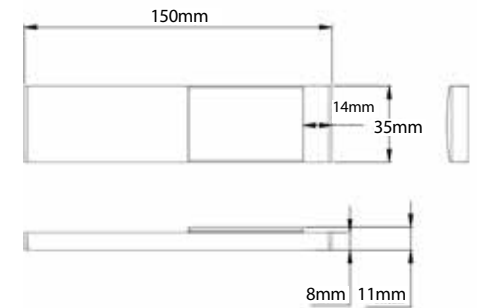
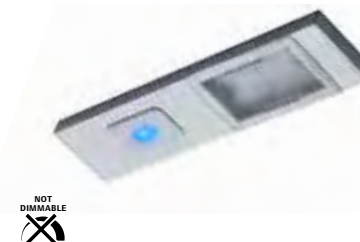

Accessories

Aluminium Cable Channel (SE7003AL) - £3.84
2.5m extension cable (SE9009) - £2.16

The non-sensor fitting can also be used with the Sensio range of switches and controllers



SE7003AL (top)

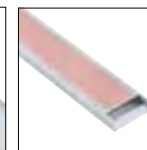

SE7003AL (bottom)

Ora Square Surface Light

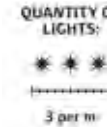

'perfect for the minimalist kitchen design'

- > Stainless Steel fitting available with either cool white or warm white LED - great for both contemporary and traditional kitchens.
- > This fitting has a depth of only 8.8mm, making it perfect where invisible lighting is required.
- > Now 72% brighter than when the product was originally launched.
- > This fitting has a luminous efficacy of 75 lm/W, making it over 20% brighter than equivalent products on the market*.
- > Use as task lighting under cabinets or to illuminate cabinet interiors in glass fronted wall units.
- > 18 High Definition LED's integrated, each diode has a lens over it to intensify the light output.
- > Long lamp life of 35,000 hours.
- > Can be used with the range of Sensio switches and dimmers.



Code	Wattage	LED Colour	Qty	Lumens	Driver	RRP
SE9007HDCW	1.8W	Cool White (5000K)	1	135 lm	■	£18.60
SE9007HDCWK2	3.6W	Cool White (5000K)	2	135 lm	6W included	£52.44
SE9007HDCWK3	5.4W	Cool White (5000K)	3	135 lm	6W included	£71.04
SE9007HDWW	1.8W	Warm White (3000K)	1	128 lm	■	£18.60
SE9007HDWWK2	3.6W	Warm White (3000K)	2	128 lm	6W included	£52.44
SE9007HDWWK3	5.4W	Warm White (3000K)	3	128 lm	6W included	£71.04

Accessories

Code	Description	RRP
SE9009	2.5m Extension Cable	£2.16

Stainless steel fitting

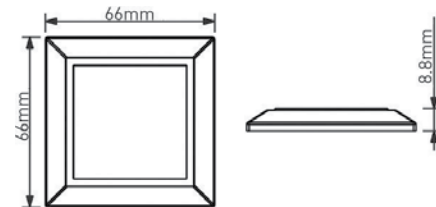

Complete with the Sensio cable connect system

Under Cabinet Spot Lighting >

Genus LED Triangle Light

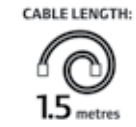
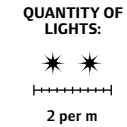

'traditional LED lighting'

- > Stainless steel triangle light with standard SMD LED chips.
- > The LED lamp in this fitting lasts 13.5 years longer than a halogen lamp (on average). Save energy and money by switching to LED lighting.
- > Energy saving, each fitting runs at only 1.1W.
- > Stainless steel finish and cool white LED, compliments grey, black, silver and white worktop tones perfectly.
- > The angled aspect of a triangle light fitting means the light is directed forward onto the worktop.
- > The centre of the fitting containing the LED's simply pops out so can be replaced down the line if required.
- > This range has recently been upgraded to give you the very best light output, longest lifespan and neatest appearance for your money.
- > Compatible with Sensio sensors and controllers.



Code	Wattage	LED Colour	Qty	Lumens	Driver	RRP
SE11010SSCW	1.1W	Cool White (5750K)	1	95 lm	12V	£14.16
SE11010SSCWK2	2.2W	Cool White (5750K)	2	95 lm	6W included	£42.72
SE11010SSCWK3	3.3W	Cool White (5750K)	3	95 lm	6W included	£57.24

Accessories

Code	Description	RRP
SE9009	2.5m Extension Cable	£2.16

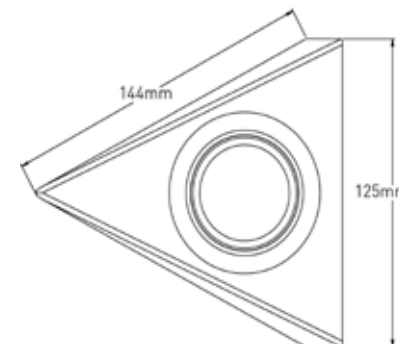

Under Cabinet Spot Lighting >

Genus LED Surface Light

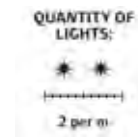

'traditional LED lighting'

- > Stainless steel recessed/surface light with standard SMD LED chips.
- > The fitting comes with the collar, however this can be removed if you wish to recess the fitting.
- > Extremely long lamp life of up to 15 years.
- > Energy saving, each fitting runs at only 1.1W.
- > Stainless steel finish, perfect for both modern or traditional kitchens.
- > Choose from cool white or warm white LED to best augment your work surface.
- > This range has recently been upgraded to give you the very best light output, longest lifespan and neatest appearance for your money.



Code	Wattage	LED Colour	Qty	Lumens	Driver	RRP
SE11025SSCW	1.1W	Cool White (5750K)	1	95 lm	■	£12.00
SE11025SSWW	1.1W	Warm White (2750K)	1	95 lm	■	£12.00
SE11025SSCWK2	2.2W	Cool White (5750K)	2	95 lm	included	£38.28
SE11025SSCWK3	3.3W	Cool White (5750K)	3	95 lm	included	£50.64

Accessories		
Code	Description	RRP
SE9009	2.5m Extension Cable	£2.16

SE11025SSCW Off



Warm white LED

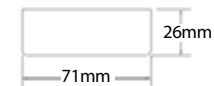

Cut-out size: Ø56mm

Anglo HD LED Wedge Light

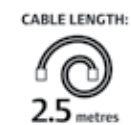
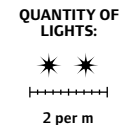
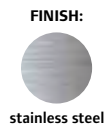

'traditional look, modern solution'

- > High Definition LED, each diode has a lens over it to intensify the light output.
- > This fitting has a luminous efficiency of 80 lm/W, making it almost 30% brighter than equivalent products on the market*.
- > Stainless Steel fitting available with either cool white or warm white LED, choose the LED colour which is best suited to the worktop.
- > The style of the fitting makes it a direct replacement for halogen under cabinet lights. Purchase in warm white LED for a very similar colour representation also.
- > Long lamp life - lasts up to 17 years more than halogen.
- > Over 90% less energy used when comparing to halogen. Save money on electricity bills when switching from halogen to HD LED.
- > Compatible with the Sensio range of switches and controllers.



Code	Wattage	LED Colour	Qty	Lumens	Driver	RRP
SE9002HDSSCW	1.65W	Cool White (5000K)	1	132 lm	■	£18.72
SE9002HDSSCWK2	3.3W	Cool White (5000K)	2	132 lm	6W included	£52.68
SE9002HDSSCWK3	4.95W	Cool White (5000K)	3	132 lm	6W included	£71.76
SE9002HDSSWW	1.65W	Warm White (3000K)	1	123 lm	■	£18.72
SE9002HDSSWWK2	3.3W	Warm White (3000K)	2	123 lm	6W included	£52.68
SE9002HDSSWWK3	4.95W	Warm White (3000K)	3	123 lm	6W included	£71.76

Accessories

Code	Description	RRP
SE9009	2.5m Extension Cable	£2.16

High output wedge light - cool white



Warm white

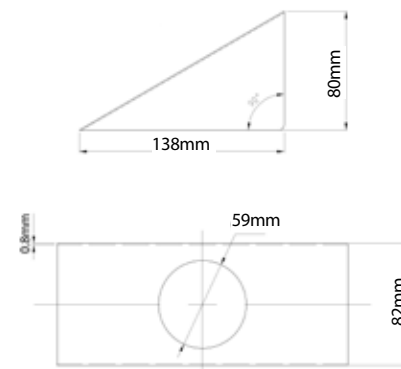

Complete with the Sensio cable connect system

Under Cabinet Spot Lighting >

Calida LED Flat Disc Light



'stylish, super thin,
compact design'

- > This fitting can be used under kitchen cabinets as a task light or inside glass fronted wall units to introduce stunning, yet discreet mood lighting.
- > The wide beam angle of the LED's in this fittings gives a superb spread of light.
- > This fitting is extremely discreet, having a depth of only 6mm.
- > Extremely low wattage. Each fitting runs at only 1.5W.
- > Available in both cool white and warm white LED. This fitting looks stunning in both contemporary and traditional kitchens alike.
- > 19 LED's integrated.
- > Surface mount using two screws or a self-adhesive pad (provided with each fitting).



Code	Wattage	LED Colour	Qty	Lumens	Driver	RRP
SE10138CW	1.4W	Cool White (5000K)	1	75 lm	■	£13.80
SE10138CWK3	4.2W	Cool White (5000K)	3	75 lm	6W included	£54.84
SE10138WW	1.4W	Warm White (3000K)	1	73 lm	■	£13.80
SE10138WWK3	4.2W	Warm White (3000K)	3	73 lm	6W included	£54.84

Accessories

Code	Description	RRP
SE9009	2.5m Extension Cable	£2.16

Cool white LED



Warm white LED

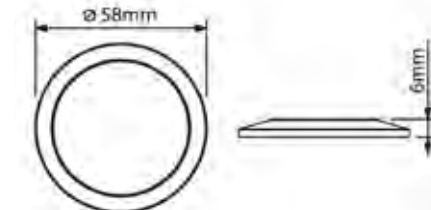

Under Cabinet Spot Lighting >

Aura Round Glass LED Light

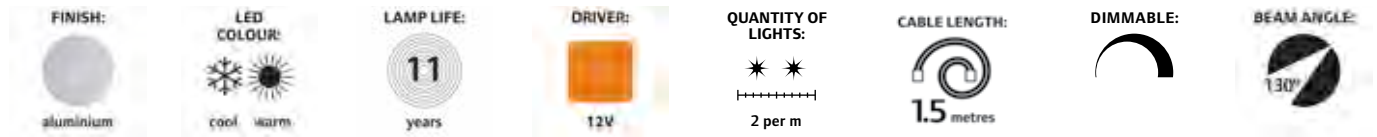

'traditional design, energy saving features'

- > Decorative LED task light. The fitting features an 8mm thick round glass surround.
- > This traditional design features an LED centre, containing 21 high output LED's.
- > Extremely low wattage. Each fitting runs at only 1.26W.
- > Available in both cool white and warm white LED. This fitting looks stunning in both contemporary and traditional kitchens alike.
- > When fixed, the glass fascia of the fitting sits 20mm from the underside of the wall unit.
- > Surface mount using two screws (provided with each fitting).
- > Use with the range of Sensio switches and controllers.



Code	Wattage	LED Colour	Qty	Lumens	Driver	RRP
SE10105C0	1.26W	Cool White (4000K)	1	71 lm	■	£21.60
SE10105C2	2.52W	Cool White (4000K)	2	71 lm	6W included	£58.08
SE10105C3	3.78W	Cool White (4000K)	3	71 lm	6W included	£80.04
SE10105W0	1.26W	Warm White (3000K)	1	71 lm	■	£21.60
SE10105W2	2.52W	Warm White (3000K)	2	71 lm	6W included	£58.08
SE10105W3	3.78W	Warm White (3000K)	3	71 lm	6W included	£80.04

Accessories

Code	Description	RRP
SE9009	2.5m Extension Cable	£2.16



Warm White LED

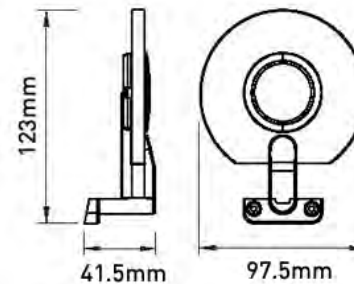

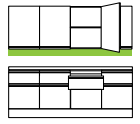

Under Cabinet Strip Lighting >



Arrow

Slim Profile SLS LED Strip Light



'continuous, diffused LED under cabinet lighting'

- > The Arrow contains a unique configuration of diffusers that evenly distribute the light, meaning there are absolutely no visible LED points.
- > This slimline fitting is extremely adaptable. We offer 4 lengths, however the strips can be seamlessly interlinked with no visible joins for a superior streamline appearance.
- > With a slim profile of only 13mm this fitting is extremely discreet.
- > Available in both cool and warm white LED, the Arrow is suitable for both contemporary and more traditional kitchen designs also.
- > A high lumen output and wide beam angle for an optimum light cast.
- > When interlinking the Arrow a maximum length of 3600mm can be achieved.
- > Each end cap measures 20mm - ensure you account for this when specifying.
- > The starter cable is to be purchased separately. One starter cable is required for each run of strips to be connected back to the driver.



Code	Wattage	Length	LED Colour	Lumens	Driver	RRP
SE9071HDCW	2.5W	200mm	Cool White (5000K)	295 lm	■	£21.84
SE9071HDWW	2.5W	200mm	Warm White (3000K)	258 lm	■	£21.84
SE9074HDCW	4W	300mm	Cool White (5000K)	472 lm	■	£27.00
SE9074HDWW	4W	300mm	Warm White (3000K)	413 lm	■	£27.00
SE9075HDCW	7.5W	570mm	Cool White (5000K)	958 lm	■	£49.20
SE9075HDWW	7.5W	570mm	Warm White (3000K)	838 lm	■	£49.20
SE9076HDCW	11.5W	870mm	Cool White (5000K)	1387 lm	■	£83.88
SE9076HDWW	11.5W	870mm	Warm White (3000K)	1213 lm	■	£83.88

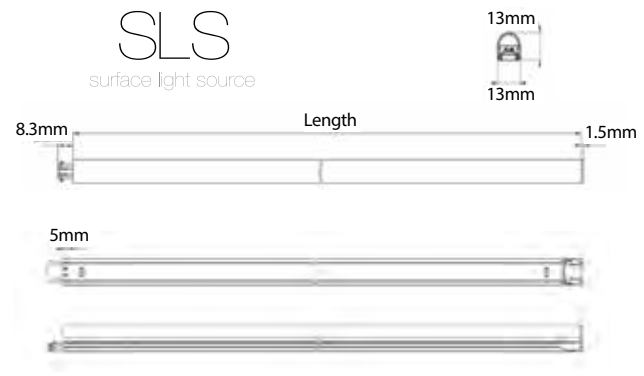
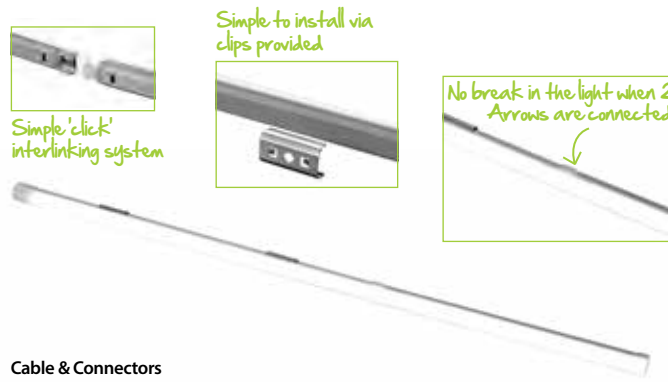

Cable & Connectors

- 1.5m Arrow Starter Cable - (SE9078HD) - £4.08
- Required to run the Arrow (at least one required per run)
- 50mm Arrow Corner Connector - (SE9077HD) - £2.76
- 500mm Inter-Connecting Cable - (SE9079HD) - £3.24



Under Cabinet Strip Lighting >

Connex 240V SLS LED Strip Light

FINISH:  aluminium	LED COLOUR:  warm	LAMP LIFE:  10 years	 240V	RECOMMENDED LOCATION: 	CABLE LENGTH:  1 metre	BEAM ANGLE:  120°
--	---	---	---	---	--	---

'the LED alternative to T5 with no visible LEDs'

- > The Connex features SLS (surface light source) technology meaning the LED points are not seen. The diffused look of the LED's produces the same look as a T5 fluorescent with an even higher light output.
- > Mains fitting for ultra simple installation.
- > Available in warm white LED, the perfect LED strip light for the more traditional kitchen design.
- > Save on energy bills. These LED options run at a much lower wattage than the fluorescent equivalents.
- > The fittings can be directly interlinked to form a continuous run of light.
- > Each fitting is supplied with 1m of mains cable for simple installation (no driver required).



Code	Wattage	Length	Lumens	Kelvin	Connection	RRP
SE10173W0	4.4W	270mm	450 lm	3000K	240V	£22.92
SE10183W0	6.4W	396mm	540 lm	3000K	240V	£24.72
SE10193W0	8.4W	524mm	720 lm	3000K	240V	£29.52
SE10203W0	10.2W	623mm	900 lm	3000K	240V	£32.04

Accessories			
Code	Description	Cable Length	RRP
SE120450	Connex Inter-Connecting Lead	500mm	£2.88
SE120750	Connex Inter-Connecting Lead	1.5m	£3.72

Use these cables between two Connex fittings when direct connection is not possible. This allows you to run a single mains cable for one run of lights.

SLS
surface light source

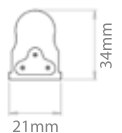
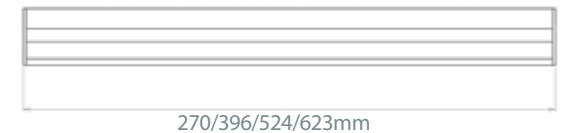
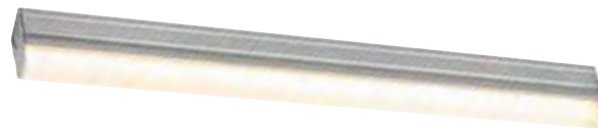

Under Cabinet Strip Lighting >

Click Slideline Track System With Sensor

FINISH:
aluminium

LED COLOUR:
cool warm

LAMP LIFE:
9 years

DRIVER:
24V

BEAM ANGLE:
60°

'customise your lighting'

- > Three lengths of the track available. However the product can be cut to size if required.
- > Effective lighting solution, the lamps click on and off of the track meaning you can add or remove lights as required simply.
- > A great solution to easily show clients the effect of both cool white and warm white LED.
- > Slide the lamps along the track to where you are working in the kitchen to heighten the level of lighting.
- > Choose a solution to suit you; choose the length of track, choose either round or square lamps in either cool or warm white LED.
- > High definition LED for a more intense light output.
- > Integrated infra-red sensor. To maintain hygiene levels the lights can be switched on/off by simply swiping your hand past the sensor.

* When calculating the driver requirement for this product, please allow an additional 1W for the sensor.



HD LED Click Slideline Track

Code	Length	Qty per pack	Cable	Driver	RRP
SE9056HD	600mm	1	1.5m included	■	£19.92
SE9057HD	900mm	1	1.5m included	■	£24.48
SE9058HD	1200mm	1	1.5m included	■	£27.36

HD LED Click Slideline Lamp

Code	Wattage	LED Colour	Shape	Lumens	Driver	RRP
SE9055HDRCW	1.65W	Cool White (5000K)	Round	80 lm	■	£21.96
SE9055HDSWCW	2W	Cool White (5000K)	Square	80 lm	■	£22.56
SE9055HDRWW	1.65W	Warm White (3000K)	Round	74 lm	■	£21.96
SE9055HDSWW	2W	Warm White (3000K)	Square	74 lm	■	£22.56

HD LED Click Slideline System With Sensor



HD LED Click Slideline Lamp



Accessories

2.5m extension cable (SE9009) - £2.16

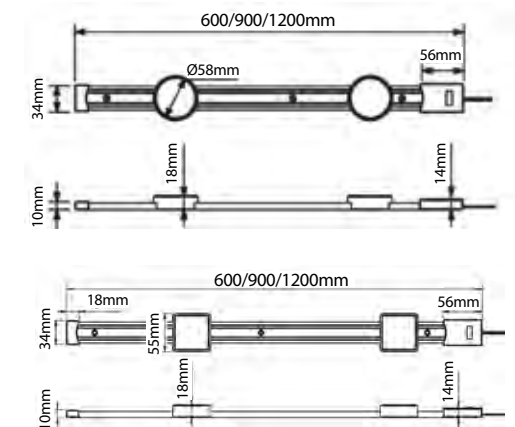

Albus LED Strip Light

FINISH:



LED COLOUR:



LAMP LIFE:



RECOMMENDED LOCATION:



BEAM ANGLE:



'ultimate ease of installation'

- > The fittings can be directly interlinked to form a continuous run of light.
- > Mains LED fitting, no external driver required.
- > Integrated on/off switch on each fitting. Switch via one fitting when in a run.
- > Each fitting contains a high number of LED's for optimum light output.
- > Angled fitting for optimum illumination of the kitchen worktop.
- > Available in cool white LED, this mains powered LED strip light has an extremely high light output to provide powerful task lighting.
- > Each fitting is supplied with a 1m length of mains cable for simple installation.



Code	Wattage	Length	Lumens	Cable	Connection	RRP
SE12250 - 250mm	2.7W	250mm	235 lm	1m included	240V	£34.80
SE12330 - 330mm	3.6W	330mm	325 lm	1m included	240V	£39.84
SE12550 - 550mm	6.8W	550mm	605 lm	1m included	240V	£57.12

Accessories		
Code	Description	RRP
SE12001	Male & Female Connector	£4.08
SE12005	500mm Link Cable	£2.88



Accessories

SE12001
Allows you to wire a length of mains cable between 2 fittings to link them together.



SE12005
To link two units together where direct interlinking is not suitable.



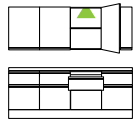

In Cabinet Lighting >



For retrofit in
cabinet lighting see
pages 118 - 123

SLS Quadra LED In Cabinet Light

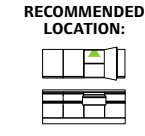
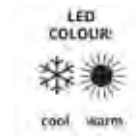

'improved design, unique to Sensio in the UK'

- > An upgrade from the original Quadra PLUS-I. Designed by Sensio in the UK this is a unique product design.
- > The specialised lens on this product diffuses the LED's to create the appearance of invisible diodes.
- > The integrated IR sensor operates the light as the cabinet door is opened/ closed. With light coloured doors the fitting can be placed 50mm from the door. With dark coloured doors the distance is 25mm.
- > Featuring a higher number of LED's than the original Quadra range for an improved light output.
- > Specially designed mounting bracket for simple installation.
- > The new elongated design allows for an increased spread of light throughout the cabinet.



Code	Wattage	LED Colour	Lumens	Driver	RRP
SE23092C0	2.5W	Cool White (5600K)	170 lm	■	£25.92
SE23092W0	2.5W	Warm White (3000K)	155 lm	■	£25.92

Optional accessories

Code	Description	RRP
SE9009	2.5m Extension Cable	£2.16
SE7003AL	300mm Quadra Cable Channel	£3.84

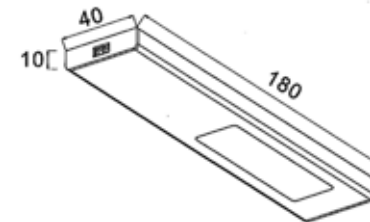

Measurements are in mm

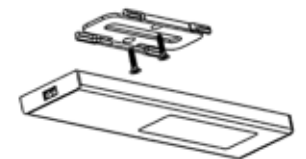

SLS
surface light source

In Cabinet Lighting >

Cona In Cabinet Light with PIR

FINISH:
aluminium

LED COLOUR:
cool

DRIVER:
12V

COLOUR TEMPERATURE:
6000K

RECOMMENDED LOCATION:

CABLE LENGTH:
2 metres

BEAM ANGLE:
120°

'ultra bright internal lighting'

- > Integrated PIR Sensor. The PIR has a detection range of 2m meaning the fitting can be mounted as required in the cabinet.
- > Various lengths to ensure great coverage for all cabinet sizes.
- > Angled light source for optimum illumination of the cabinet interior.
- > The high number of HD LED diodes integrated ensures an even illumination.
- > Cool white LED, the brightest light source.



Code	Wattage	Length	No of LEDs	Lumens	Driver	RRP
SE7200HDCW	2.7W	400mm	36	160 lm	■	£55.44
SE7205HDCW	3.6W	550mm	48	215 lm	■	£63.96
SE7208HDCW	5.7W	850mm	78	320 lm	■	£86.40
SE7210HDCW	6.3W	950mm	87	355 lm	■	£93.36
SE7215HDCW	7.8W	1150mm	108	515 lm	■	£110.64

Accessories		
Code	Description	RRP
SE9009	2.5m Extension Cable	£2.16

With PIR

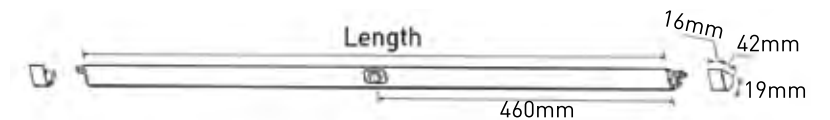

Picca

In Cabinet Light With IR Sensor

FINISH:
aluminium

LED COLOUR:
cool warm

DRIVER:
24V

RECOMMENDED LOCATION:

CABLE LENGTH:
1.5 metres

BEAM ANGLE:
70°

'make the most of your cabinet interior'

- > Integrated IR sensor on the front edge of the fitting, for on/off switching activated by the opening and closing of the cabinet door.
- > The light floods to the back of the cabinet for optimum illumination.
- > Cool white for maximum illumination, warm white for wooden carcasses .
- > High Definition LED's integrated.
- > Low wattage fittings – minimal energy usage.
- > **Also suitable to be used in wardrobes.**



Code	Wattage	Length	LED Colour	Lumens	Driver	RRP
SE9080HDCW	2W	430mm	Cool White (5000K)	77 lm	■	£40.20
SE9080HDWW	2W	430mm	Warm White (3000K)	71 lm	■	£40.20

Accessories

Code	Description	RRP
SE9009	2.5m Extension Cable	£2.16

In Cabinet light With IR Sensor Integrated

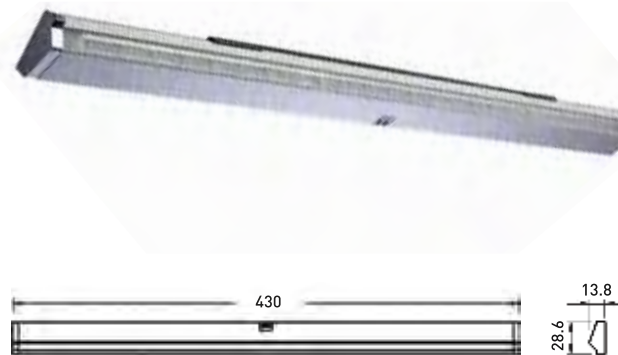

Picca

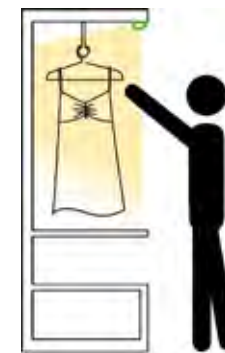

No glare

T5 equivalent



Inca

Internal Light with PIR Sensor

FINISH:
aluminium

LED COLOUR:
cool warm

DRIVER:
12V

RECOMMENDED LOCATION:

CABLE LENGTH:
1.5 metres

BEAM ANGLE:
60°

'lighting just where you need it'

- > Integrated PIR Sensor. The PIR has a detection range of 2m meaning the fitting can be mounted as required in the cabinet.
- > Fitting can be surface mounted or recessed.
- > Both cool white and warm white available, choose which best suits the cabinet.
- > Slimline fitting, the ultimate solution for discreet interior lighting.
- > Adds an element of luxury to your kitchen.
- > Perfect for use in larders and wardrobes as well as kitchen cabinets.



Code	Wattage	Length	LED Colour	Lumens	Driver	RRP
SE7400HDCW	2.3W	420mm	Cool White (6000K)	138 lm	■	£39.72
SE7400HDWW	2.3W	420mm	Warm White (3000K)	120 lm	■	£39.60
SE7405HDCW	2.9W	520mm	Cool White (6000K)	156 lm	■	£46.80
SE7405HDWW	2.9W	520mm	Warm White (3000K)	125 lm	■	£46.80

Accessories

Code	Description	RRP
SE9009	2.5m Extension Cable	£2.16

In Cabinet Light with PIR Sensor



Surface mounted



Recessed

Surface mounted

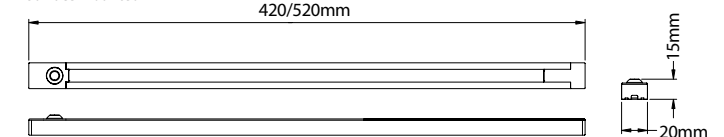

Recess mounted

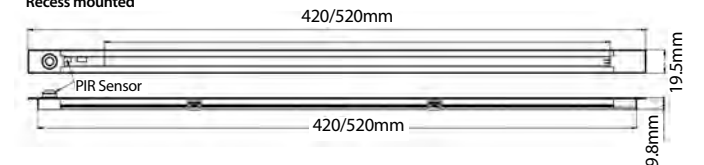

In Cabinet Lighting >

Quadra PLUS - I LED In Cabinet Light

FINISH:



aluminium

LED
COLOUR:



cool warm

DRIVER:



12V

RECOMMENDED
LOCATION:



CABLE LENGTH:



1.5 metres

BEAM ANGLE:



140°

'neat and stylish lighting just where you need it'

- > The lens of the fitting has a Triphosphur coating to ensure an even spread of light.
- > IR sensor integrated on the front edge of the fitting, the light is activated on the opening of the cabinet door. When the door is closed the light will switch off.
- > Low wattage fitting – minimal energy usage.
- > Ideal for smaller cabinets.
- > Both cool white and warm white available, choose which best suits the cabinet.



Code	Wattage	LED Colour	Lumens	Driver	RRP
03.1000.0610	2.5W	Cool White (5325K)	113 lm	■	£23.04
03.1000.0620	2.5W	Warm White (3050K)	113 lm	■	£22.92

Accessories

Code	Description	RRP
SE9009	2.5m Extension Cable	£2.16

In Cabinet Light

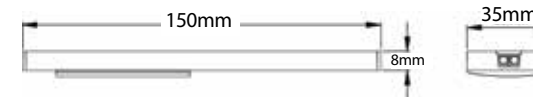
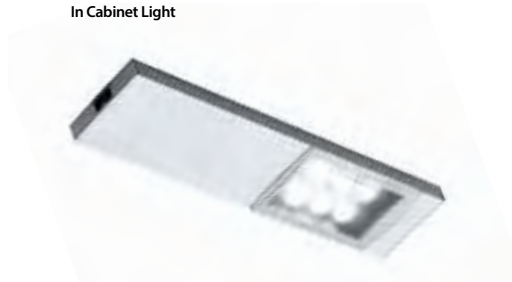

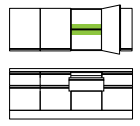

Shelf Lighting >



Shelf Lighting >

Edge SLS LED Glass Clip Light

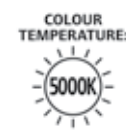

'glass shelves are a feature. Light them'

- > Fits a 6-8mm pane of glass.
- > Use on glass shelves inside glass fronted cabinets to introduce soft, ambient mood lighting.
- > The white diffused finish of the profile means the lights shines out towards the front edge of the glass and illuminates the inside of the cabinet itself also.
- > Can be cut to length if required (every 90mm or 7 LED's along the PCB).
- > Features an integrated diffuser for the 'no dot' look on the front edge of the glass.
- > Extremely low wattage, meaning minimal energy consumption.
- > Use two lengths side by side for longer units.
- > Simple to install, clips onto the back of a glass pane and connects up to the suitable driver.
- > A relatively low cost item which creates a stunning effect.



Code	Wattage	Length	LED's	Lumens	Driver	RRP
SE9063HDCW	2W	450mm	35	281 lm	■	£16.68

Accessories		
Code	Description	RRP
SE9009	2.5m Extension Cable	£2.16

SLS
surface light source

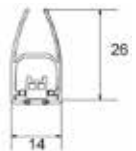

Inset shows the integrated diffuser on the Edge LED Glass Clip Light.



Measurements in mm

Arc LED Glass Box Shelf

FINISH:



aluminium

LED COLOUR:



cool

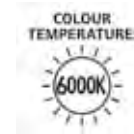

LAMP LIFE:



years

RECOMMENDED LOCATION:



CABLE LENGTH:



'updated version of an old favourite'

- > Fitting has an aluminium frame with panes of glass on both the top and bottom.
- > High output, cool white LED strip integrated.
- > On/off switch integrated (located on the underside of the shelf – to the right hand side when fit).
- > LED driver built-in so no need to purchase and fit a separate driver.
- > Extremely long lifespan of the LED strip integrated so there is no need for replacement lamps.
- > The LED's in this fitting have a total lifespan of 50,000 hours.
- > The frosted glass panes on this fitting diffuse the LED's for absolutely no visible LED points.
- > The maximum weight load of the shelf is 5kg.
- > Slimline design, depth of only 50mm.



Code	Wattage	Length	LEDs	Lumens	Connection	RRP
07.1120.0610	5.8W	450mm	24	528 lm	240V	£87.72
07.1121.0610	7.9W	600mm	33	726 lm	240V	£92.04
07.1122.0610	12W	900mm	51	1122 lm	240V	£116.64

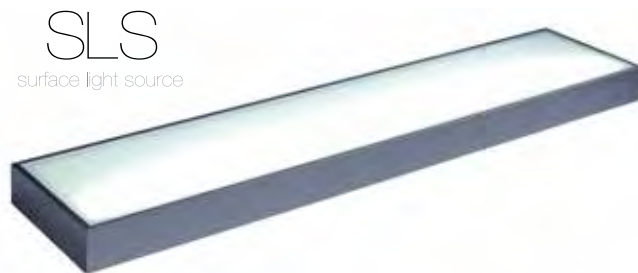

SLS
surface light source

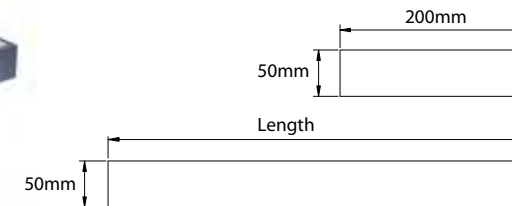

Florence

IP44 LED Glass Shelf Light

FINISH:



aluminium

LED COLOUR:



cool

COLOUR TEMPERATURE:



LAMP LIFE:



years

RECOMMENDED LOCATION:



CABLE LENGTH:



1 metre

'add ambience and additional storage space'

- > The Florence has an aluminium frame containing a high power LED strip light. A pane of frosted glass slots into the frame and a diffused and subtle lighting effect is created.
- > High output, cool white LED strip integrated.
- > On/off switch integrated (located on the underside of the shelf – to the right hand side when fit).
- > LED driver built-in so no need to purchase and fit a separate driver.
- > Long lifespan of the LED strip integrated so there is no need for replacement lamps.
- > The maximum weight load of the shelf is 3kg.
- > IP44 rated, protected against splashing water. This fitting is perfect if you require additional storage space/illumination in close proximity to the sink. (The shelf must be fit a minimum of 0.6m away from the sink).



Code	Wattage	Length	Width	Connection	RRP
SE30156W0	12W	500mm	135mm	240V	£73.32

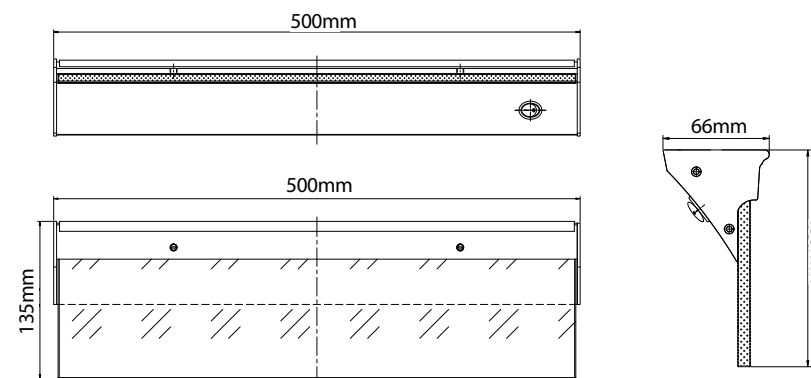
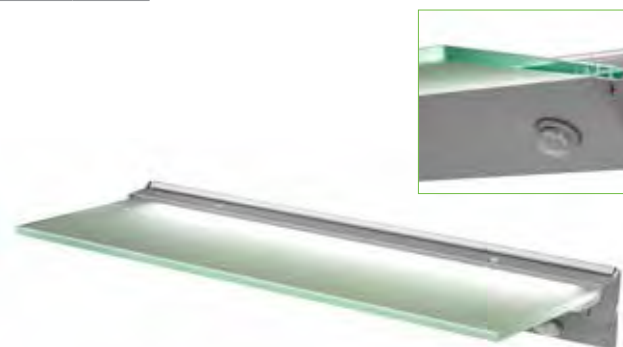

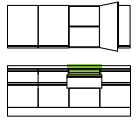

Drawer Lighting >



Drawer Lighting >

Verso LED Drawer Light

FINISH:



aluminium

LED COLOUR:



cool

DRIVER:



12V

COLOUR TEMPERATURE:



RECOMMENDED LOCATION:



CABLE LENGTH:



2 metres

BEAM ANGLE:



120°

'the ultimate functional light'

- > Various lengths available to suit standard drawer carcasses.
- > Cool white high definition LED to provide optimum light output.
- > IR sensor integrated on the front edge of the fitting, as soon as the drawer is opened the light will illuminate. Once the drawer is closed the fitting will switch off immediately to ensure no energy wastage.
- > The ideal solution to illuminate pan drawers.
- > Low wattage, meaning a full drawer stack can be illuminated using only one LED driver.
- > Brackets and cable tidy supplied.
- > This fitting is suitable for use in both the kitchen and the bedroom.



Code	Wattage	Length	LEDs	Lumens	Driver	RRP
SE7300HDCW	2.6W	462mm	33	205 lm	■	£39.00
SE7305HDCW	3.3W	562mm	42	250 lm	■	£45.72
SE7310HDCW	4.5W	762mm	60	340 lm	■	£52.20
SE7315HDCW	5.4W	862mm	72	380 lm	■	£58.68
SE7320HDCW	6W	962mm	81	430 lm	■	£67.20
SE7325HDCW	7.3W	1162mm	99	515 lm	■	£73.80

Accessories

Code	Description	RRP
SE9009	2.5m Extension Cable	£2.16

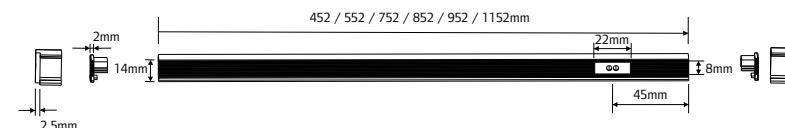

Vista LED Battery Drawer Light

FINISH:



aluminium

LED COLOUR:



cool

BATTERY OPERATED:



RECOMMENDED LOCATION:



BEAM ANGLE:



'no wiring - anyone can install'

- > No wiring necessary so anyone can install this fitting.
- > Requires 4 x AAA batteries to run (not included).
- > IR Sensor in-built (located in the centre of the fitting).
- > Two functions of this fitting:
 - Use as a drawer/in-cabinet light (the light switches on with the opening of a drawer/door).
 - Use as an under unit light (the light switches on/off when a hand passes the sensor).
- > When used for 3 minutes per day the batteries in the fitting will last approximately 1.5 years.
- > 5cm detection range of the IR Sensor.
- > The function-switch button is on the back of the fitting, press once to change the function of the product.



Code	Wattage	Cable	Power Source	Kelvin	RRP
SE9030HD	0.8W	n/a	4 x AAA Batteries	6500K	£26.40



1. If mounted inside a drawer, select the monostable function.
2. Open the drawer, light turns on.
3. Close the drawer, light turns off.



1. If mounted underneath a cabinet, select the bistable function.
2. Move hand within 5cm of the IR sensor, light turns on.
3. Move hand within 5cm of the IR sensor once more, light turns off.

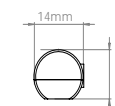
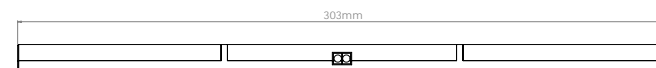

Idea!

Fit in the drawer where the torches and batteries are kept in case of a power cut.

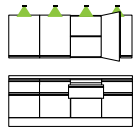

Over Cabinet Lighting >

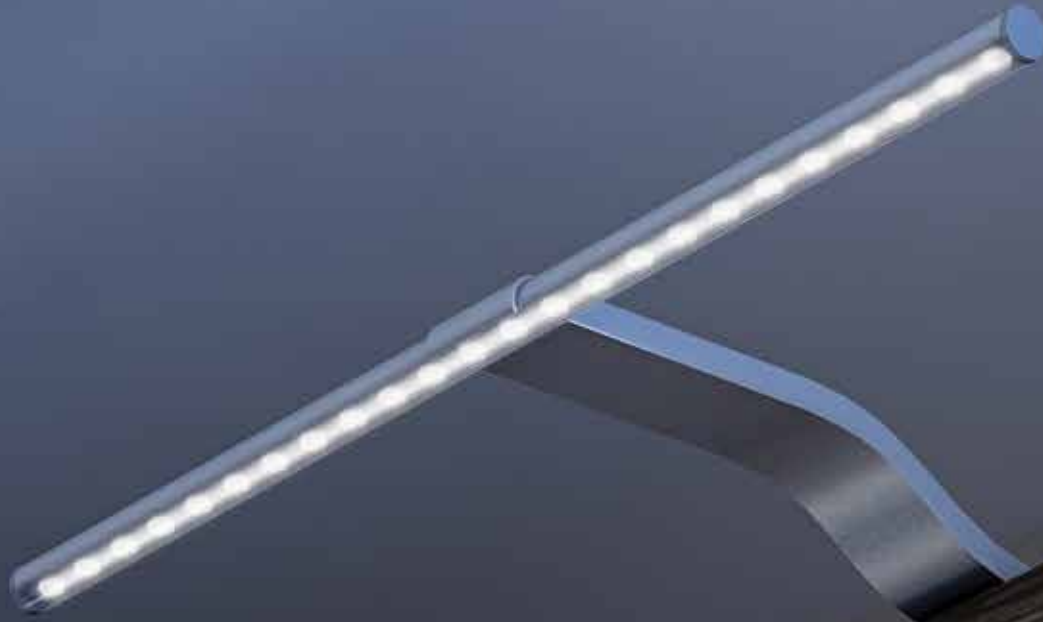

Asta Over Cabinet Light



'optimum illumination of cabinet fronts'

- > Fitting has an adjustable head for optimum illumination of the cabinet front (adjusts by 30°).
- > Available in both cool white and warm white LED, allowing you to create the perfect mood lighting to suit your cabinetry.
- > 24 high definition LED diodes integrated in each fitting.
- > The 340mm head of the fitting ensures an even illumination across the cabinet front.
- > Can also be used above wardrobes.
- > A simple way to introduce mood lighting into the kitchen or bedroom.

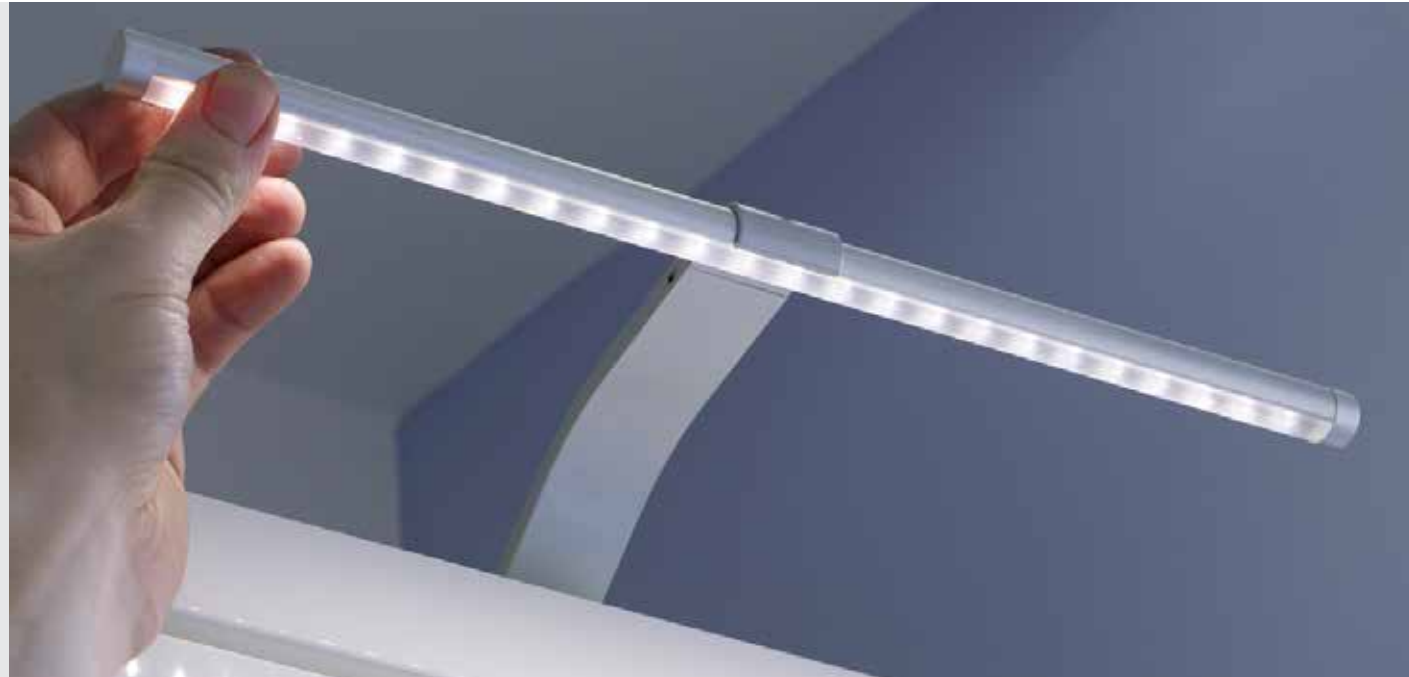

Code	Wattage	LED Colour	Qty	Lumens	Driver	RRP
SE9015HDCW	1.65W	Cool White (5000K)	1	77 lm	■	£25.44
SE9015HDCWK2	3.3W	Cool White (5000K)	2	77 lm	6W included	£69.36
SE9015HDCWK3	4.95W	Cool White (5000K)	3	77 lm	6W included	£94.80
SE9015HDWW	1.65W	Warm White (3000K)	1	71 lm	■	£25.92
SE9015HDWWK2	3.3W	Warm White (3000K)	2	71 lm	6W included	£73.68
SE9015HDWWK3	4.95W	Warm White (3000K)	3	71 lm	6W included	£99.60

Accessories		
Code	Description	RRP
SE9009	2.5m Extension Cable	£2.16

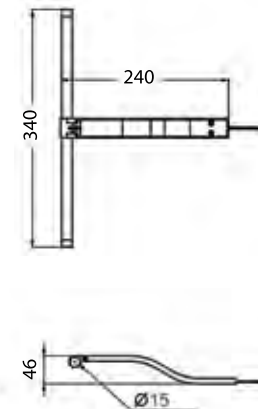

Quadra PLUS - O LED Over Cabinet Light

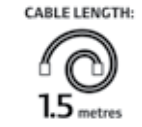

'it's all about the doors'

- > The lens on this fitting has a Triphosphor coating, creating an even spread of light from the LED diodes integrated.
- > Use this fitting to create mood lighting by illuminating the cabinet fronts.
- > Both cool white and warm white available, choose which best suits the cabinetry.
- > Long lamp life and extremely low energy consumption.
- > This fitting can also be used above wardrobes.



Code	Wattage	LED Colour	Qty	Lumens	Driver	RRP
04.1000.0610	2.4W	Cool White (5650K)	1	113 lm	■	£17.16
04.1000.0612	4.8W	Cool White (5650K)	2	113 lm	6W included	£62.76
04.1000.0613	7.2W	Cool White (5650K)	3	113 lm	15W included	£79.44
04.1000.0620	2.4W	Warm White (3000K)	1	113 lm	■	£17.16
04.1000.0622	4.8W	Warm White (3000K)	2	113 lm	6W included	£61.20
04.1000.0623	7.2W	Warm White (3000K)	3	113 lm	15W included	£77.76

Quadra LED Over Cabinet Light

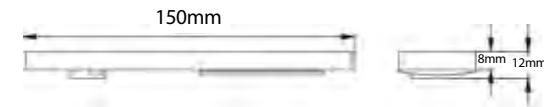

Accessories		
Code	Description	RRP
SE9009	2.5m Extension Cable	£2.16

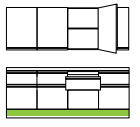

Plinth Lighting >



We've reformatted our plinth light packs

- Run larger quantities from one driver
- Switch and dim using Sensio sensors and controllers
- New pack sizes
- Individual add on's now available
- Makes buying and installing Sensio plinth lights much simpler

Applies to the following; Luce, Puro & Specto.



Features as follows;

- > 4 & 8 light packs available.
- > Single add-on units available.
- > Packs include a standard Sensio 6W driver with 4 port JB4 distribution block (■ SE40553).
- > You have the ability to order the exact number of plinth lights you need to run from a single driver (either included in the kit or buy as separate components).
- > The plinth lights can now be used with the Sensio range of sensors/controllers and the Sensio Multi-Light App.

Luce SLS LED Square Plinth Light

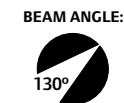
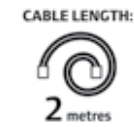
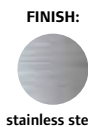

'invisible LED's'

- > The stainless steel surround provides a high quality finish.
- > The fitting has 3 concealed LED's integrated into the top edge to create a diffused light effect with no visible LED points.
- > Available as a 4 or 8 light pack, containing a 6W driver.
- > Individual fittings also available should you wish to have more than 8 fittings in a single run from one driver.
- > Light sits flush to the plinth for a sleek and stylish look.
- > Fittings daisy chain together for simple installation.
- > Suited to both contemporary and modern kitchens as you can choose from both cool & warm white LED.
- > Compatible with Sensio 24V switches and dimmers.
- > The driver in the packs (SE40553) has a maximum allowance of 6W .
A maximum of 10 fittings can be run from the one driver (based on the fittings being daisy chained).



Code	Wattage	LED Colour	Lumens	Light Qty	Driver	RRP
SE15090C0	0.6W	Cool White (4000K)	16 lm	1	■	£4.80
SE15090W0	0.6W	Warm White (3000K)	16 lm	1	■	£4.80
SE15090C4	2.4W	Cool White (4000K)	16 lm	4	6W included	£35.40
SE15090W4	2.4W	Warm White (3000K)	16 lm	4	6W included	£35.40
SE15090C8	4.8W	Cool White (4000K)	16 lm	8	6W included	£56.16
SE15090W8	4.8W	Warm White (3000K)	16 lm	8	6W included	£56.16

SLS
surface light source

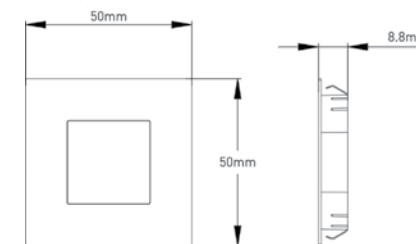

Cut-out size: Ø44mm

Luce single light fitting and SE40553 driver (which is included in the the 4 & 8 light kits).

Puro LED Round Plinth Light

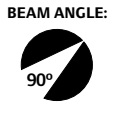

'compact & simple,
yet very effective'

- > Available as pack, containing 4 or 8 fittings and 1 x 6W driver.
- > Individual fittings also available should you wish to have more than 8 fittings in a single run from one driver.
- > The fitting itself is completely transparent – the perfect invisible dot plinth lighting solution.
- > 15mm fittings – very discreet.
- > The fittings daisy chain together for simple installation.
- > 2 x 1m cables per fitting.
- > Compatible with Sensio 24V switches and dimmers.
- > The driver in the packs (SE40553) has a maximum allowance of 6W .
A maximum of 25 fittings can be run from the one driver (based on the fittings being daisy chained).



Code	Wattage	LED Colour	Lumens	Light Qty	Driver	RRP
SE15094C0	0.24W	Cool White (5500K)	10 lm	1	■	£4.08
SE15094W0	0.24W	Warm White (3000K)	10 lm	1	■	£4.08
SE15094C4	0.96W	Cool White (5500K)	10 lm	4	6W included	£32.52
SE15094W4	0.96W	Warm White (3000K)	10 lm	4	6W included	£32.52
SE15094C8	1.92W	Cool White (5500K)	10 lm	8	6W included	£50.16
SE15094W8	1.92W	Warm White (3000K)	10 lm	8	6W included	£50.16

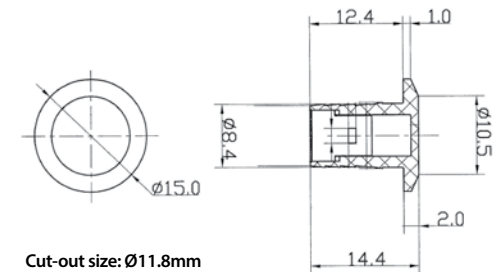

Puro single light fitting and SE40553 driver (which is included in the the 4 & 8 light kits).

Plinth Lighting >

Specto LED Round Plinth Light

FINISH:



chrome

LED COLOUR:



cool warm

LAMP LIFE:



9 years

DRIVER:



24V

RECOMMENDED LOCATION:



CABLE LENGTH:



2 metres

BEAM ANGLE:



90°

'stylish, discreet fitting, stunning effect'

- > Available as a pack, containing either 4 or 8 fittings and 1 x 6W driver.
- > Individual fittings also available should you wish to have more than 8 fittings in a single run from one driver.
- > Each fitting runs at only 0.16W.
- > IP65 rated (protected against water ingress).
- ideal for use on the kitchen plinth or in zone 1 area's of the bathroom.
- > 15mm fittings – very discreet.
- > Chrome surround with an individual LED per fitting.
- > The fittings daisy chain together for simple installation.
- > Compatible with Sensio 24V switches and dimmers.
- > 6W driver included in the packs (SE40553) meaning a maximum of 37 fittings could be run from the one driver (based on fittings being daisy chained).



Code	Wattage	LED Colour	Lumens	Light Qty	Driver	RRP
SE15091C0	0.16W	Cool White (5500K)	8 lm	1	■	£5.40
SE15091W0	0.16W	Warm White (3000K)	8 lm	1	■	£5.40
SE15091C4	0.64W	Cool White (5500K)	8 lm	4	6W included	£38.16
SE15091W4	0.64W	Warm White (3000K)	8 lm	4	6W included	£38.16
SE15091C8	1.28W	Cool White (5500K)	8 lm	8	6W included	£61.68
SE15091W8	1.28W	Warm White (3000K)	8 lm	8	6W included	£61.68

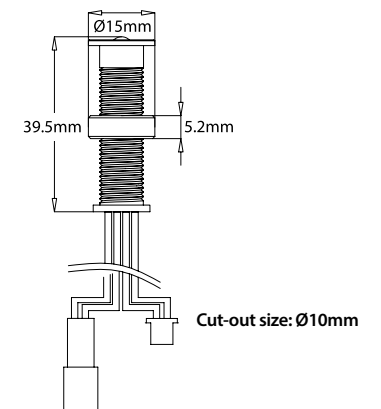

Specto single light fitting and SE40553 driver (which is included in the the 4 & 8 light kits).

Fyra LED Square Plinth Light

FINISH:
satin chrome

LED COLOUR:
cool warm

LAMP LIFE:
11 years

RECOMMENDED LOCATION:

CABLE LENGTH:
2 metres

BEAM ANGLE:
120°

'set the mood'

- > Pack includes; 4 x fittings and 1 x plugged LED driver
- > The driver in this pack has a maximum allowance of 4W.
A maximum of 8 fittings can be run from the one driver.
- > Fittings daisy chain together for simple installation.
- > Both cool white and warm white LED available to suit both contemporary and traditional kitchens.
- > Only 0.5W per fitting for minimal energy usage.
- > Simple to install, press fit with self-adhesive backing on each fitting for additional support.
- > Each fitting has 1 x 500mm cable and 1 x 1500mm cable for daisy chain connection.
- > Plugged LED driver included in the pack - ready to connect straight to the mains supply.

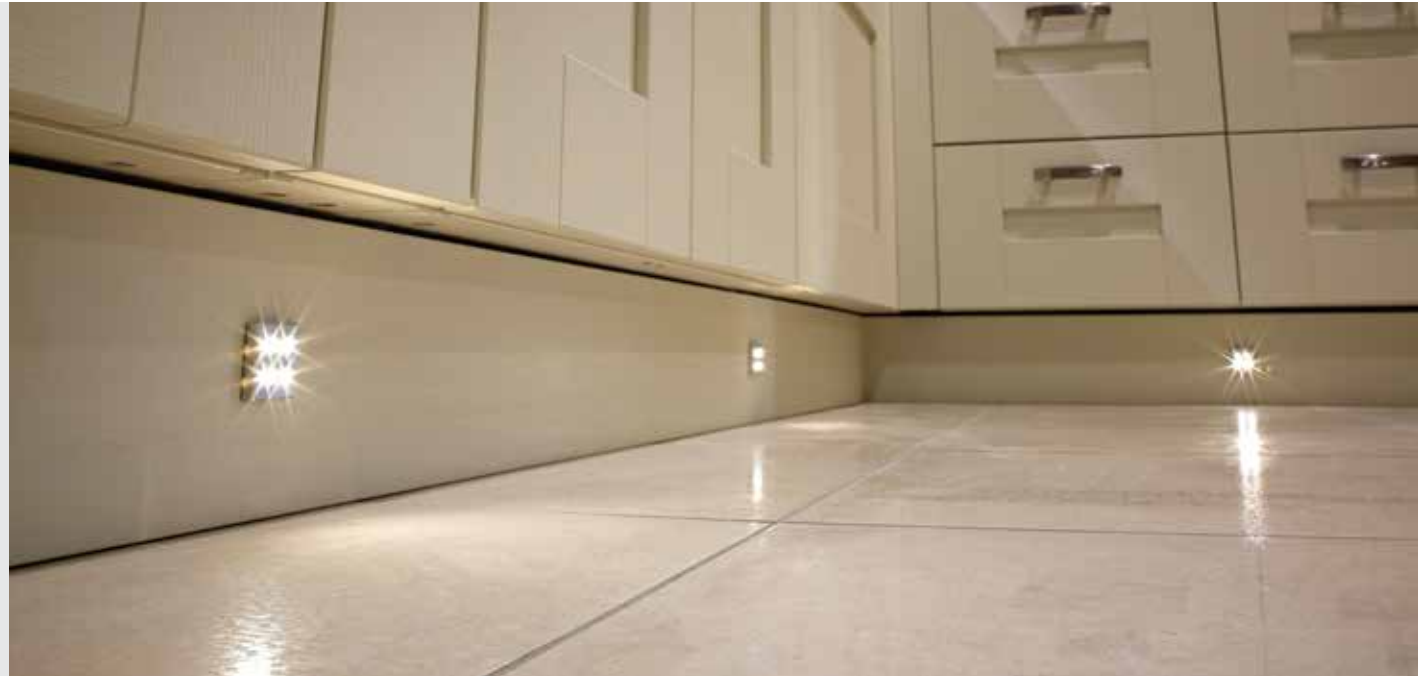

Code	Wattage	LED Colour	Lumens	Light Qty	Driver	RRP
SE10133CW	2W	Cool White (6500K)	16 lm	4	included	£33.60
SE10133WW	2W	Warm White (3000K)	15 lm	4	included	£33.60

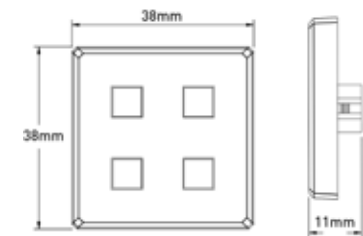

Cut-out size: Ø10mm

Plinth Lighting >

Nimbus LED Plinth Light Kit

FINISH:

stainless steel

LED COLOUR:

cool

LAMP LIFE:

18.5
years

CABLE LENGTH:

1.5 metres

RECOMMENDED
LOCATION:

BEAM ANGLE:

30°

'mood lighting for the kitchen or bathroom'

- > IP67 rated fittings suitable for use on kitchens plinths or in bathrooms.
- > All components required are included in the pack (6 fittings and LED driver).
- > 2 x 500mm cables on each individual fitting. 1.5 metres of mains cable from the driver (includes 13A plug).
- > Quality stainless steel fitting.
- > The maximum walkover pressure is 100kg.
- > As well as using in a plinth, this fitting is also suitable for use in ceramic tiles, natural stone, hard wood or Quartz flooring.
- > Cool white LED, an ideal plinth lighting option for the contemporary kitchen design.
- > Low energy consumption, each fitting runs at only 0.3W.
- > The maximum wattage load of the driver in this pack is 8W.



Code	Wattage	LED Colour	Qty	Cable	Lumens	Driver	RRP
SE10196CWC	1.8W	Cool White (5500K)	6	1m PF*	22.8 lm	8W included	£46.08

* PF - per fitting

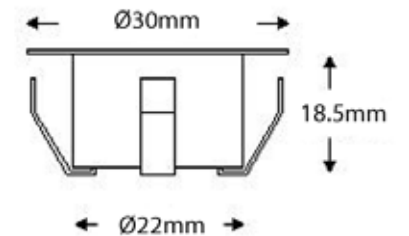

Cut-out size: Ø24mm

Senza Up/Down Light with Driver



'use in the plinth, hallway or staircase walls'

- > Available in a matt black or matt white finish.
- > The fitting has a powerful 1W LED integrated into the top/bottom edge (dependant on mounting) to create a flood of light onto the floor or up the wall.
- > Anti-glare design as the LED is concealed.
- > Each fitting is supplied with it's own individual 350mA driver pre-wired and a 15cm length of mains cable from the driver.
- > The matt white finished product is perfect if discreet or invisible lighting is required in the plinth on a neutral kitchen or wall.
- > The matt black finish is perfect if a contrasting finish is required.
- > Light sits flush to the plinth/wall for a sleek and stylish look.
- > The wattage of the driver supplied with each fitting is 6W.
- > Simple design, stunning effect.



Code	Wattage	Finish	LED Colour	Lumens	Driver	RRP
SE15002C0	1W	Matt White	Cool White (5000K)	73 lm	6W included	£32.16
SE15002W0	1W	Matt White	Warm White (3000K)	49 lm	6W included	£32.16
SE15008C0	1W	Matt Black	Cool White (5000K)	73 lm	6W included	£32.16
SE15008W0	1W	Matt Black	Warm White (3000K)	49 lm	6W included	£32.16

The above listings are for one Senza light fitting with connected driver



Senza: available in a white or black finish.
Each fitting is supplied with its own LED driver.

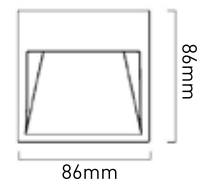

Cut-out size: 80mm x 80mm



Flexible Strip Lighting >



An introduction to flexible strip lighting...

Flexible strip quick selection guide

There are a few things you need to know before selecting the best flexible strip for your design. Our quick selection guide below will help you make a quick and informed decision.

	Compact	Vega	Viva	Primo	RGB	DuoFlex
Maximum length of strip you can run from a single driver	8m	6.6m	12m	13.75m	10m	6m
Available lengths	1m & 2m	1m & 2m	30cm, 1m & 2m	5m	33cm & 2m	1m & 2m
LED colour	CW & WW	CW & WW	CW & WW	CW & WW	RGB	Mix CW & WW
Number of LED's	90	36	36	72	36	36/72
Brightness	360 lm	503 lm	107.5 lm	342 lm	180 lm	300 lm
How many times the strip can be cut and re-used	Once	Once	Once	Up to 50	None	None
Product section visual						

Figures are based on a 1m length, Cool White LED & using the largest driver available (or the maximum allowance). The RGB & DuoFlex can be cut however the cut section cannot be re-used.

Our designer suggests...

Add depth to your kitchen by adding flexible strip lighting above wall units, along the plinth or under the worktop.



Flexible Strip Lighting >

Vega HD LED Flexible Strip

FINISH:



white

LED COLOUR:



cool warm

LAMP LIFE:



9 years

DRIVER:



24V

RECOMMENDED LOCATION:



DIMMABLE:



BEAM ANGLE:



'the brightest LED flexible strip light'

- > Self-adhesive 3M tape backing allows for quick and simple installation.
- > High light output, 3.5 times brighter than the Viva flexible LED strip light.
- > Male and female ends on the strip allow you to create the length required.
- > The strip can be cut to length, scissor marks on the product mark where suitable to cut (every 55-56mm).
- > Cut the strip ONCE and re-use the cut off piece using the mini-cut connector (SE90317HD).
- > Use this product for a variety of applications (on the plinth, on the underside of the bed, above cabinets/wardrobes to up-light the ceiling to name a few).
- > All you need to install is an adequate amount of flexible strips, driver connection lead(s) – one per run of strips and an LED driver.
- > Run a maximum length of 6.66m from one driver (based on the 50W driver).
- > Use with all ■ (24V) sensors/controllers.



Code	Wattage	Length	LED's	LED Colour	Lumens	Driver	RRP
SE90310HDCW	2.5W	330mm	12	Cool White (5000K)	168 lm	■	£20.88
SE90310HDWW	2.5W	330mm	12	Warm White (3000K)	155 lm	■	£20.88
SE90311HDCW	7.5W	1000mm	36	Cool White (5000K)	503 lm	■	£51.60
SE90311HDWW	7.5W	1000mm	36	Warm White (3000K)	465 lm	■	£51.60
SE90312HDCW	15W	2000mm	72	Cool White (5000K)	1005 lm	■	£92.52
SE90312HDWW	15W	2000mm	72	Warm White (3000K)	930 lm	■	£92.52

Packs (includes; 1 x flexible strip, 1 x driver connection lead & 1 x 15W driver).

SE90311HDCWK1	7.5W	1000mm	36	Cool White (5000K)	503 lm	included	£72.96
SE90311HDWWK1	7.5W	1000mm	36	Warm White (3000K)	465 lm	included	£72.96
SE90312HDCWK1	15W	2000mm	72	Cool White (5000K)	1005 lm	included	£111.12
SE90312HDWWK1	15W	2000mm	72	Warm White (3000K)	930 lm	included	£111.12

SE90317HD Cut Joining Connector



Cables

HD LED Flexible Strip Driver Connection Lead – 2500mm - (SE90314HD) - £2.64
Required to run the HD LED Flexible Strip

HD LED Flexible Strip Inter-Connecting Lead – 500mm - (SE90315HD) - £2.28
HD LED Flexible Strip Corner Connection Lead – 50mm - (SE90316HD) - £1.92
HD LED Flexible Strip Cut Joining Connector - (SE90317HD) - £0.96
2.5m Extension Cable - (SE9009) - £2.16



SE90314HD



SE90315HD



SE90316HD

Compact Multi-point LED Flexible Strip

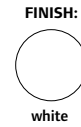

'more diodes, closer together - no dark spots'

- > A higher number of diodes per flexible strip means there are minimal dark spots. This provides a sleeker finish when used on a plinth in a kitchen with a glossy tiled floor or in a profile.
- > Self-adhesive 3M tape backing allows for quick and simple installation.
- > Male and female ends on the strip allow you to create the length required.
- > The strip can be cut to length, scissor marks on the product mark where suitable to cut (every 65mm).
- > Cut the strip ONCE and re-use the cut off piece using the mini-cut connector (SE90317HD).
- > Use this product for a variety of applications (on the plinth, on the underside of the bed, above cabinets/wardrobes to up-light the ceiling to name a few).
- > All you need to install is an adequate amount of flexible strips, driver connection lead(s) – one per run of strips and a LED driver.
- > Run 8m from one 50W driver (an extra 1.34m than the Vega).



Code	Wattage	Length	LED's	LED Colour	Lumens	Driver	RRP
SE20015C0	6W	1000mm	90	Cool White (5000K)	360 lm	■	£51.60
SE20015W0	6W	1000mm	90	Warm White (3000K)	330 lm	■	£51.60
SE20025C0	12W	2000mm	180	Cool White (5000K)	720 lm	■	£104.64
SE20025W0	12W	2000mm	180	Warm White (3000K)	660 lm	■	£104.64

Packs (includes; 1 x flexible strip, 1 x driver connection lead & 1 x 15W driver).

SE20015C1	6W	1000mm	90	Cool White (5000K)	360 lm	included	£72.96
SE20015W1	6W	1000mm	90	Warm White (3000K)	330 lm	included	£72.96
SE20025C1	12W	2000mm	180	Cool White (5000K)	720 lm	included	£125.88
SE20025W1	12W	2000mm	180	Warm White (3000K)	660 lm	included	£125.88

Compact - multi-point flexible strip



More diodes closer together to reduce dark spots



Cable & Connectors

HD LED Flexible Strip Driver Connection Lead – 2500mm - (SE90314HD) - £2.64
 Required to run the Compact LED Flexible Strip

HD LED Flexible Strip Inter-Connecting Lead – 500mm - (SE90315HD) - £2.28
 HD LED Flexible Strip Corner Connection Lead – 50mm - (SE90316HD) - £1.92
 HD LED Flexible Strip Cut Joining Connector - (SE90317HD) - £0.96
 2.5m Extension Cable - (SE9009) - £2.16



Viva LED Flexible Strip

FINISH:



white

LED COLOUR:



cool warm

LAMP LIFE:



9 years

DRIVER:



12V

RECOMMENDED LOCATION:



DIMMABLE:



BEAM ANGLE:



'can be used almost anywhere'

- > Self-adhesive 3M tape backing allows for quick and simple installation.
- > Male and female ends on the strip allow you to create the length required.
- > The strip can be cut to length, scissor marks on the product mark where suitable to cut (every 75-83mm).
- > Cut the strip ONCE and re-use the cut off piece using the mini-cut connector (SE10318MCC).
- > Extremely low energy consumption, only 5W per 2000mm.
- > Use this product for a variety of applications (on the plinth, on the underside of the bed, above cabinets/wardrobes to up-light the ceiling to name a few).
- > All you need to install is an adequate amount of flexible strips, driver connection lead(s) – one per run of strips and a LED driver.
- > Run a maximum length of 12m from one driver (based on using the 30W driver).



Code	Wattage	Length	LED No.	LED Colour	Lumens	Driver	RRP
SE10310CW	0.8W	300mm	12	Cool White (5000K)	36 lm	■	£9.96
SE10310WW	0.8W	300mm	12	Warm White (3200K)	36 lm	■	£9.96
SE10312CW	2.5W	1000mm	36	Cool White (5000K)	107.5 lm	■	£25.68
SE10312WW	2.5W	1000mm	36	Warm White (3200K)	107.5 lm	■	£25.68
SE10311CW	5W	2000mm	72	Cool White (5000K)	215 lm	■	£50.76
SE10311WW	5W	2000mm	72	Warm White (3200K)	215 lm	■	£50.76

Packs (includes; 1 x flexible strip, 1 x driver connection lead & 1 x 6W or 15W driver).

SE10312CWK1	2.5W	1000mm	36	Cool White (5000K)	107.5 lm	included	£45.00
SE10312WWK1	2.5W	1000mm	36	Warm White (3200K)	107.5 lm	included	£45.00
SE10311CWK1	5W	2000mm	72	Cool White (5000K)	215 lm	included	£77.04
SE10311WWK1	5W	2000mm	72	Warm White (3200K)	215 lm	included	£77.04

2m Flexible LED Strip Light



SE10318MCC Cut Joining Connector

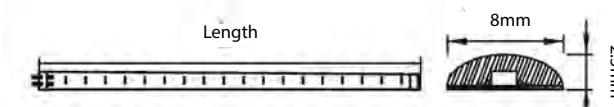

Cables/Accessories



Cable & Connectors

LED Flexible Strip Driver Connection Lead – 2500mm - (SE10314) - £2.04
Required to run the Viva Flexible LED Strip Light.

LED Flexible Strip Corner Connection Lead – 50mm - (SE10316) - £0.96
LED Flexible Strip Inter-Connecting Lead – 500mm - (SE10315) - £1.32
LED Flexible Strip Inter-Connecting Lead – 1500mm - (SE10317) - £1.68

Accessories

LED Flexible Strip Cut Joining Connector (SE10318MCC) - £0.60
2.5m Extension Cable - (SE9009) - £2.16

Primo

5m Clip LED Flexible Strip

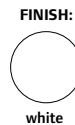

'cut and reconnect up to 50 times!'

- > This customisable flexible strip allows you to illuminate several areas of a room using just one strip.
- > Supplied as a 5m reel.
- > The strip can be cut every 100mm, scissor marks on the product mark where suitable to cut.
- > The strip has connection points every 100mm. When cutting the strip and reconnecting or connecting the first strip; slide the strip into the clip connector so the connectors sit under the 2 prongs and push down the clip head. (Ensure the polarity is correct as you do this).
- > Each reel is supplied with 3M self-adhesive backing and Silicon fixing clips for secure installation.
- > Use this versatile product for a variety of applications.
- > All you need to install is a 5m Primo reel, driver connection lead(s) – one per run of strips and a LED driver.

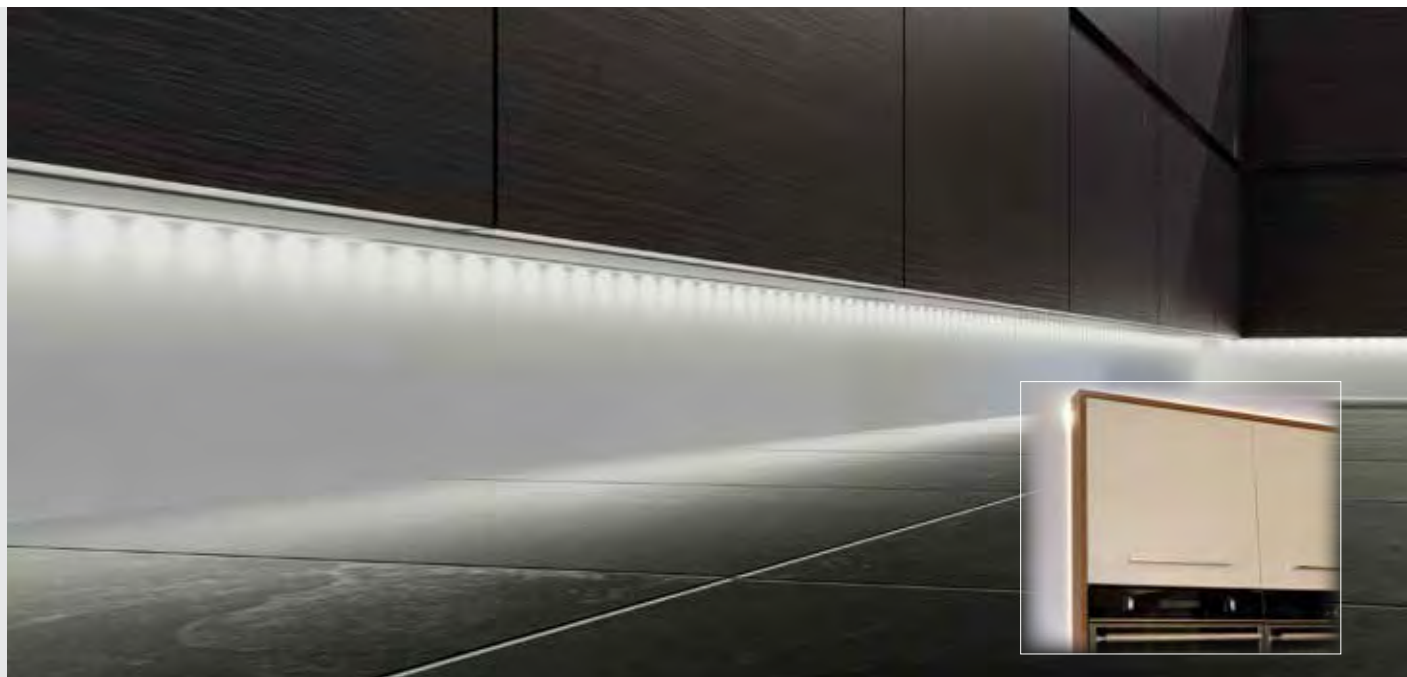

Code	Wattage	Length	LED's	LED Colour	Lumens	Driver	RRP
SE1005C0	18W	5m	357	Cool White (5000K)	1709 lm	■	£83.04
SE1005W0	18W	5m	357	Warm White (3000K)	1555 lm	■	£83.04
Packs*							
SE1005C1	18W	5m	357	Cool White (5000K)	1709 lm	included	£119.04
SE1005W1	18W	5m	357	Warm White (3000K)	1555 lm	included	£119.04

* Each pack contains; 1 x SE1005C0/W0 (5m Primo reel), 1 x SE101080 (2.5m driver lead) & 1 x SE40556 (30W LED driver).

Primo - 5m Clip Flexible Strip Reel



The strip has connection points every 100mm, the strip can be cut at each of these points. When cutting the strip and reconnecting or connecting the first strip; slide the strip into the clip connector so the connectors sit under the 2 prongs, and push down the clip head. (Ensure the polarity is correct as you do this).

Cable & Connectors

Primo 2.5m Driver Connection Cable - (SE101080) - £3.60
Required to run the Primo Flexible Strip

Primo Interconnecting Clip - (SE100050) - £1.20
 Primo 50mm Corner Connector - (SE101050) - £2.16

2.5m Extension Cable - (SE9009) - £2.16



DuoFlex Flexible Strip

FINISH: white	LED COLOUR: cool natural warm	LAMP LIFE: 13 years	DRIVER: 24V	RECOMMENDED LOCATION: 	DIMMABLE: 	BEAM ANGLE: 120°
-----------------------------	---	-----------------------------------	---------------------------	----------------------------------	----------------------	--------------------------------

'seamlessly mix colour to create the perfect mood'

- > The DuoFlex brings real flexibility to the flexible strip light range. With only one flexible strip the LED colour can be set from warm white through the full spectrum to cool white.
- > Self-adhesive 3M backing allows for quick and simple installation.
- > Male and female ends on the strip allow you to create the length required.
- > The strip can be cut to length, scissor marks on the product mark where it is suitable to cut (every 165mm). The strip can be cut once and once cut that is the end of the run. The cut piece with the female end cannot be reused.
- > Operate using a remote control, inline switch or Sensio Multi-Light app. One remote will control all receivers within a 15m radius.
- > A maximum length of 6m of the DuoFlex can be run from each receiver.
- > Ten brightness levels of the LED, dim or brighten in 10% increments.
- > The wattage of the driver included in the packs is 30W.



DuoFlex - warm white

Main image shows the DuoFlex set to cool white

Code	Wattage	Length	LED No.	Colour Temp.	Lumens	Driver	RRP
SE10011D0	3.75W	1000mm	72	2700-5000K	282-300 lm		£42.24
SE10021D0	7.5W	2000mm	144	2700-5000K	282-300 lm		£80.04

Packs

Code	Wattage	Length	Cable	Controller	Driver	RRP
SE10053D1	7.5W	2000mm	2 x 2.5m	Inline switch	included in pack	£116.64
SE10073D1	7.5W	2000mm	2 x 2.5m	Remote & Receiver	Included in pack	£156.36

SE1003000 - DuoFlex Remote Control (see page 89 for details)

SE1004100 - DuoFlex Receiver (see page 89 for details)

SE1006300 - DuoFlex Inline Switch (see image opposite & page 89 for pricing)

Cool white & warm white diodes side by side. The strip is marked at intervals where it can be cut.



From top to bottom: warm white LED, natural white LED and cool white LED.



Cable/accessories

Driver Connection Lead – 2500mm - (SE10325) -£2.52
One driver lead is required for each run of the DuoFlex.

DuoFlex Inter-Connecting Lead – 500mm (SE10328) - £2.40
 DuoFlex Corner Connection Lead – 50mm (SE10327) - £1.56

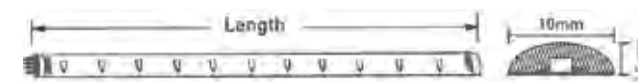

The Inline Switch
 - included in the SE10053D1 Starter Pack
 - order separately - SE1006300

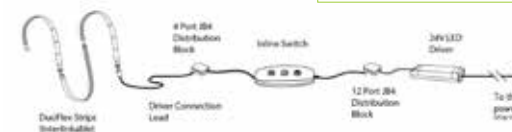

DuoFlex Remote Control

'control both LED colour and brightness'

- > The DuoFlex remote control allows you to choose from both cool white and warm white LED, or to create a natural white tone by mixing the two colours.
- > One remote can control multiple receivers (as many as you require, within a 15m radius), allowing you to control DuoFlex located in different areas of the kitchen.
- > Functions of the DuoFlex remote control:
 - Rotate the colour temperature wheel to select the desired colour temperature.
 - Decrease the brightness level of the DuoFlex strips (in 10% increments).
 - Increase the brightness level of the DuoFlex strips (in 10% increments).
 - On/off – switch the connected fittings on/off.
 - Memory function of the last setting before switched off.
 - Radio Signal - the maximum range of the remote control is 15m.



Code	Product Description	Max Wattage	Driver	RRP
SE1003000	DuoFlex Remote Control	n/a	■	£22.44
SE1004100	DuoFlex Receiver	22.5W per receiver	■	£30.96
SE1006300	DuoFlex Inline Switch	30W	■	£13.56

NB: When buying the DuoFlex flexible strip lighting, you require a driver, driver connection lead and controller (either Inline Switch or Remote & Receivers) for each run of strips. These are purchased separately (unless buying in a pack). One receiver is required for each driver.



The SE40555 15W driver will run a maximum of 4m of the DuoFlex.
The SE40556 30W driver will run a maximum of 6m of the DuoFlex.

The maximum length of the DuoFlex which can be run from one DuoFlex receiver is 6m.

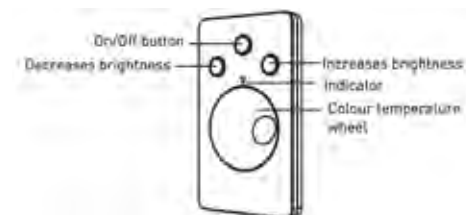

Remote Receiver

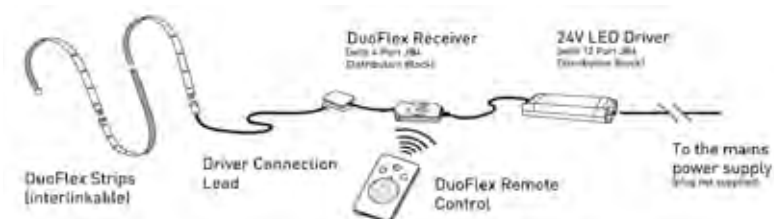
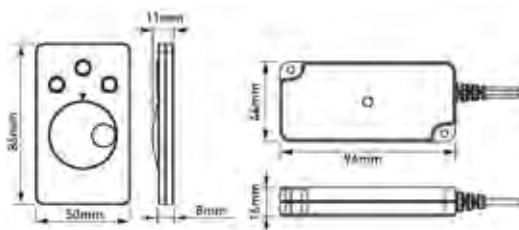

RGB Colour Changing Flexible Strip

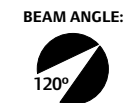

'7 colours, 3 effects'

- > Self-adhesive 3M tape backing allows for quick and simple installation.
- > 7 preset colours of the RGB (cool white, violet, yellow, cyan, green, red and blue).
- > The perfect product to create mood lighting, either set to one of the 7 colours, or select the slow or rapid colour change option.
- > Male and female ends on the strip allow you to create the length required.
- > The strip can be cut to length, scissor marks on the product mark where suitable to cut (every 75-83mm).
- > Use the RGB remote control or Sensio Multi-Light app to create the effect or choose the colour that is perfect for you at the touch of a dial.
- > All you need to install is an adequate amount of flexible strips, driver connection lead(s) – one per run of strips, driver and a RGB control.
- > Run a maximum length of 10m from one driver.
- > When using the RGB remote control, each new run of RGB strip lighting requires a driver and a receiver, however multiple receivers can now be controlled via one remote control.



Code	Wattage	Length	LED Colour	No. of LED's	Driver	RRP
SE10005R0	1.8W	330mm	RGB	12pcs	■	£10.92
SE10025R0	10W	2000mm	RGB	72pcs	■	£66.00

Pack

Code	Wattage	Length	Cable	Includes	RRP
SE10160R1	10W	2000mm	2 x 2.5m	1 x 30W Driver, 1 x Receiver & 1 x Remote	£181.68

LED RGB Colour Changing Flexible Strip Light



SE793990 - RGB LED Bluetooth Receiver for Sensio Multi-Light Control app. [See page 135.](#)

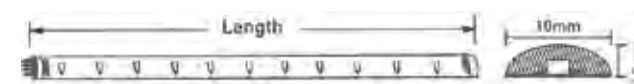

Cables

LED RGB Flexible Strip Driver Connection Lead - 2500mm (SE10325) - £2.52
Required to run the RGB LED flexible Strip

LED RGB Flexible Strip Corner Connection Lead - 50mm (SE10327) - £1.56
LED RGB Flexible Strip Inter-Connecting Lead - 500mm (SE10328) - £2.40

Cables/Accessories



Accessories

30W RGB Inline Switch (SE790990)
60W RGB Receiver (SE791050)
RGB Remote Control (SE791090)

RGB Remote Control

'quickly and easily set the mood'

- > Create the effect or choose a single colour that is perfect for you.
- > Multiple receivers can be controlled from one remote control (all receivers within a 15m radius of the remote at any one time).
- > 24V system allows for 60W of RGB product to be run per receiver.
- > Functions of the RGB remote control:
 - Single colour mode – select one colour by rotating the wheel
 - Gradual colour change – light colour gradually changes
 - Flashing colour change mode – light colour rapidly changes
 - Colour change speed – change the speed at which the colours change
 - Brightness level – change through the 3 brightness levels of the RGB
 - On/off – switch the connected fittings on/off
- > Memory function of the performance before last switched off.
- > Radio Signal - Maximum range of controller is 15m.
- > The remote control is powered by a 3V button lithium battery (supplied).



Code	Product Description	Max Wattage	Driver	RRP
SE791090	RGB Remote Control	n/a	■ ■	£41.04
SE791050	RGB Receiver	30W/60W per receiver	■ ■	£29.76
SE790990	RGB Inline Switch	15W/30W	■ ■	£10.80

NB: reference the maximum wattages stated above, the lower value relates to 12V (orange) and the higher value, 24V (green).

When buying Sensio RGB lighting, you require a driver, driver connection lead and controller (either Inline Switch or Remote & Receivers) for each run of strips. These are purchased separately (unless buying in a pack). One receiver is required for each driver.

RGB Inline Switch



RGB Remote Control



RGB Remote Control

Single colour; gradual colour change; rapid colour change; change colour change speed; dim; on/off

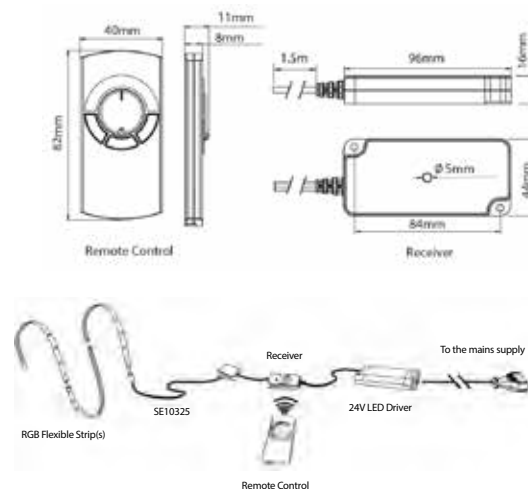
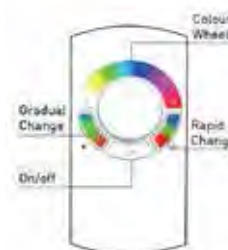

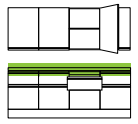

Integrated
Solutions >



Fino Surface Mounted Profile



'customisable lighting'

- > Choose from our range of flexible strip lighting to create the perfect solution for your customer.
- > Select the HD LED flexible strip light for the ultimate light output, use under a cabinet to create a continuous run of streamlined task lighting.
- > The profile is extremely slim to create the ultimate discreet lighting solution.
- > Aluminium profile with a frosted cover.
- > The profile protects the flexible strip light from dust and moisture, and ultimately creates a more professional finish.
- > A versatile solution as both the profile and flexible strip can be cut to length. Perfect when you have bespoke sizes to meet.
- > Butt lengths of the profile together if a longer run is required.
- > Use this product under kitchen cabinets, inside wardrobes or inside kitchen cabinets.
- > End caps and mounting brackets included.



Code	Length	LED Strip	Cable	Driver	RRP
10.1000.0600	1m	Profile only	N/A	N/A	£12.72
10.1004.0600	2m	Profile only	N/A	N/A	£23.28

Flexible Strip Lighting sold seperately - see pages 84-90 for options.

Accessories		
Code	Description	RRP
10.1016.0602	2 x End caps for Surface Mounted Profile	£1.20
10.1018.0602	2 x Mounting Brackets for Surface Mounted Profile	£1.20



End caps and mounting brackets included

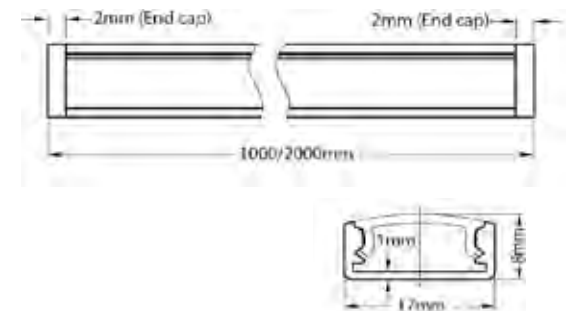

10.1016.0602



10.1018.0602

Linia

Recessed Aluminium Profile

FINISH:
aluminium

RECOMMENDED
LOCATION:

'flush fit for a minimalist look'

- > Perfect for use under kitchen cabinets, inside larders or inside wardrobes.
- > Create the perfect task lighting or convenience lighting by selecting the LED flexible strip light with the required output or effect.
- > Use with one of our in cabinet sensor switches (pages 139 & 140) when using inside a larder or cabinet so the light comes on as the door opens and switches off as the door is closed.
- > The profile is extremely slim to create the ultimate discreet lighting solution.
- > Aluminium profile with a frosted cover.
- > A versatile solution as both the profile and flexible strip can be cut to length.
- > Butt lengths together for longer runs.



Code	Length	LED Strip	Cable	Driver	RRP
10.1008.0600	1m	Profile only	N/A	N/A	£10.08
10.1012.0600	2m	Profile only	N/A	N/A	£20.16

Flexible Strip Lighting sold separately - see pages 84-90 for options.

Accessories		
Code	Description	RRP
10.1017.0602	2 x End caps for Recessed Profile	£1.20
10.1019.0602	2 x Mounting brackets for Recessed Profile	£1.20



Recessed Aluminium Profile

End caps and mounting brackets included

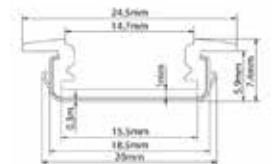
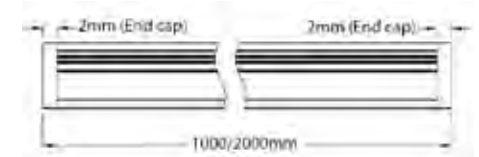

Cut-out
Width: 18.5mm - 19mm
Depth: 6mm - 6.2mm



10.1017.0602



10.1019.0602

Continuum Profile

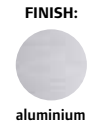

'diffused light for a professional finish'

- > Integrated lighting, designed to be seen.
- > Create stunning mood lighting with this product. The profile diffuses the LED's for the ultimate professional finish.
- > A key design consideration would be to fit this product beneath the worktop or to router into the worktop itself.
- > Another consideration would be to face fix the profile at plinth height.
- > Use around the frame of a wardrobe or walk-in wardrobe to create a stunning and unique look.
- > Choose from the comprehensive range of LED flexible strip lights to create the perfect lighting solution you envisage.
- > Butt lengths together for longer runs.
- > Versatile product as the profile and the flexible strip can be cut to length.



Code	Length	LED Strip	Cable	Driver	RRP
10.1032.0600	1m	Profile only	N/A	N/A	£15.00
10.1036.0600	2m	Profile only	N/A	N/A	£27.96

Flexible Strip Lighting sold seperately - see pages 84-90 for options.

Accessories		
Code	Description	RRP
10.1040.0602	2 x End caps for Continuum Profile	£1.20

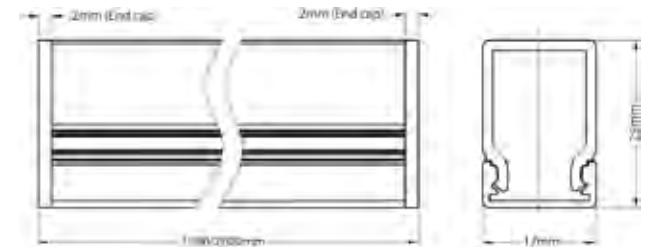
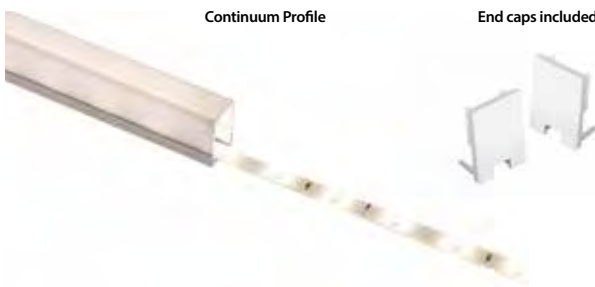

Sensio *Midway* Hanging Rail



The ultimate solution for kitchen organisation and illumination

- Illuminated hanging rail system to be mounted midway between the wall units and the work surface.
- A Sensio product design. Unique to Sensio in the UK.
- Build your own solution:
 - Four accessories available; large shelf, small shelf, utensil holder & kitchen roll holder.
 - Pick any flexible strip from the range to include inside the profile.
- Keep worktops clear and necessities to hand.
- Designed, developed, perfected.

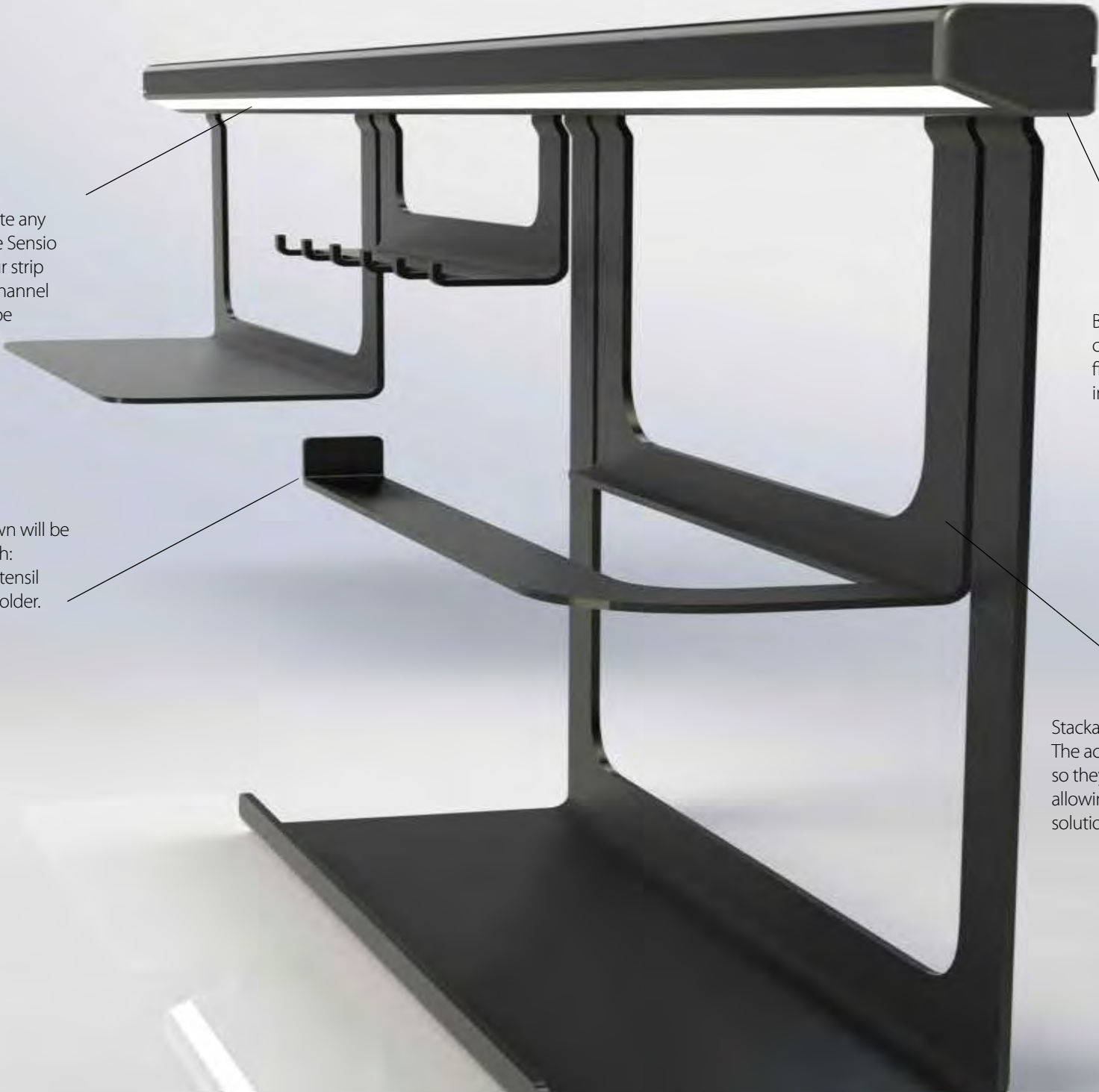

Midway will accommodate any flexible LED strip from the Sensio range, simply choose your strip and insert in the profile channel (driver and cable also to be purchased separately).

Branded end caps with cable channel for a high quality, neat finish and complete ease of installation.

The four accessories shown will be available in the first launch: Large Shelf, Small Shelf, Utensil Hooks and Kitchen Roll Holder.

Stackable accessories. The accessories have been developed so they can be sat against one another, allowing you more usable storage solutions in a compact space.

Designed and developed by Sensio in the UK. Completely unique product design.



Sensio Midway V1 Hanging Rail System



'kitchen organisation at its best'

- > Midway allows you to utilise the space between your wall units and worktop, providing task lighting and that essential additional storage space.
- > Build your perfect solution.
- > Designed by Sensio in the UK this is a completely unique product.
- > Two finishes of the Midway rail and accessories available; silver or black.
- > Four initial accessories available; kitchen roll holder, utensil holder, small shelf and large shelf.
- > The profile is available in a 1m length, however if a longer length is required simply butt two profiles alongside one another.
- > Choose any flexible strip from the Sensio range and simply slot into the profile channel. Midway has been carefully designed to ensure all Sensio flexible strips fit the channel.
- > The profile can be cut to length (ensure chosen accessories fit if you do cut).
- > The profile and accessories have an extremely high quality finish.
- > The cable can come through either the left or right side of the profile
- > Branded end caps included.

Available Q2 2016



Code	Length	LED Strip	Cable	Driver	RRP
SE180221	1m	Profile only	N/A	N/A	£40.44
SE18012C1	1m	SE20015C0 included	2.5m included	6W included	£117.96

Flexible Strip Lighting sold seperately - see pages 84-90 for options.

Or buy the kit above which contains the Compact flexible strip, cable and driver.

Accessories		
Code	Description	RRP
SE180520	Small Shelf	£40.20
SE180620	Large Shelf	£52.20
SE180720	Utensil Hooks	£28.68
SE180920	Kitchen Roll Holder	£37.56



Midway Profile

Kitchen Roll Holder



Utensil Hooks



Small Shelf



Large Shelf



UK Product Design

Sensio Midway V1 Hanging Rail System



Midway Profile



Kitchen Roll Holder



Utensil Hooks



Small Shelf



Large Shelf

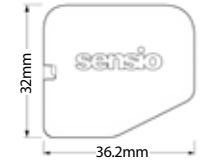
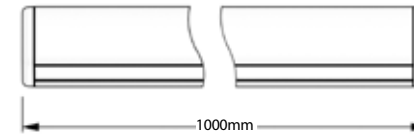

The profile is extremely simple to install

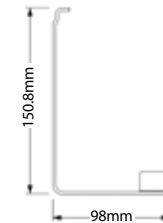

Kitchen Roll Holder

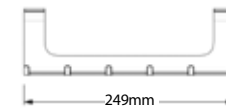

Utensil Hooks

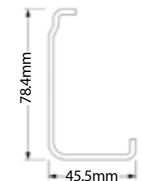

Code	Length	LED Strip	Cable	Driver	RRP
SE180821	1m	Profile only	N/A	N/A	£40.44
SE18018C1	1m	SE20015C0 included	2.5m included	6W included	£117.96

Flexible Strip Lighting sold separately - see pages 84-90 for options.

Or buy the kit above which contains the Compact flexible strip, cable and driver.

Accessories		
Code	Description	RRP
SE180530	Small Shelf	£40.20
SE180630	Large Shelf	£52.20
SE180730	Utensil Hooks	£28.68
SE180930	Kitchen Roll Holder	£37.56

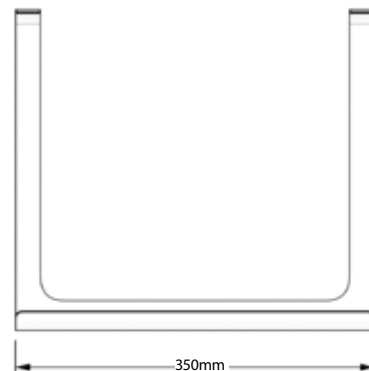

Large Shelf

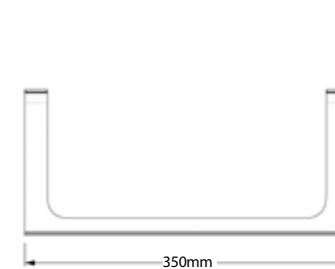
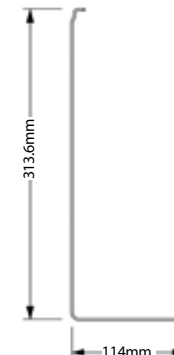

Small Shelf

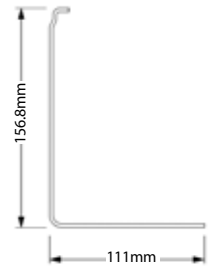

Dimensional drawings apply to both the silver and the black finish

Ceiling Lighting >



GU10 Fire Rated Ceiling Spot Light

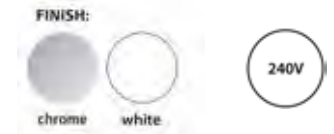

'complete your lighting scheme'

- > Fire rated fitting - up to 90 minutes fire rated. This fitting has been tested and proved to maintain the integrity of the surface in which it is fit . The fitting will expand if heated above a certain temperature and fill any gaps around it, containing fire.
- > Part B/C/E compliant.
- > IP65 rated fitting.
- > GU10 fitting. Runs at 240V so no external transformer or driver is required.
- > Available in a choice of 2 finishes; chrome or white.
- > Two LED lamp types to choose from; a GU10 high output LED lamp or a GU10 dimmable COB LED lamp.
- > Choose the required finish, then select the LED lamp you'd like, choosing from warm white or cool white LED.

* Lamps not included with the fittings - purchase separately



Code	Finish	Power Supply	IP Rating	Cut out	RRP
SE30034W0	White	240V	IP65	75mm	£35.64
SE30042W0	Chrome	240V	IP65	75mm	£37.68

Lamps

Code	Wattage	LED Colour	Lumens	Beam angle	RRP
SE37005C0	4W	Cool White (6000K)	360 lm	30°	£10.56
SE37005W0	4W	Warm White (2500K)	290 lm	30°	£10.56
SE37105C0	4W	Cool White (6000K)	330 lm	37°	£14.52
SE37105W0	4W	Warm White (2500K)	310 lm	37°	£14.52



SE30034W0



SE30042W0



SE37005C0/W0



SE37105C0/W0

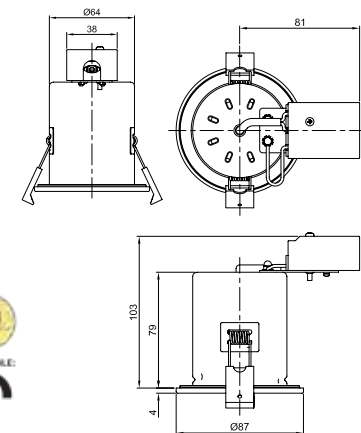

Wireless Charging >



Qi Wireless Charger



'integrated wireless charging for the kitchen'

- > Integrate into the work surface for a flush fit, discreet and convenient wireless charging solution.
- > Simply sit any Qi enabled mobile device on top of the charger. If your device does not have Qi built-in an additional interface is required (see options below).
- > Removes the need for power cords. Simply place your phone on the charger for convenient charging whilst you're cooking or entertaining.
- > Charging distance 0-6mm.
- > Two finishes available; black and white. The white finish option has a silver finish around the edge of the fitting.
- > The charger must be fitted with a 25mm clearance from the edge of the work surface. The maximum worktop depth item is suitable for is 60mm.
- > The lip is only 1mm deep for a completely flush fit.
- > Input: DC 5V - 1.5A. Output: DC 5V - 1A.



Code	Finish	Connection	Wattage	RRP
SE870980	Black	Micro USB cable (plug not included)	5W	£61.56
SE870990	White	Micro USB cable (plug not included)	5W	£61.56

Phone cases

SE871980	Qi Wireless Charging Receiver Phone Case (Black) - iPhone 5s	£57.24
SE872980	Qi Wireless Charging Receiver Phone Case (Black) - iPhone 6	£57.24
SE873980	Qi Wireless Charging Receiver Phone Case (Black) - iPhone 6+	£57.24

Accessories

SE2007000	Pluggable USB Charger with 5m cable	£10.68
-----------	-------------------------------------	--------

The charger above is to be purchased if you require a longer cable than the 1.5m supplied. This also comes with a plug should you not have a suitable adapter.



SE870980



SE870990



SE871980



A phone case is only required for mobile devices which do not have qi capabilities built in.

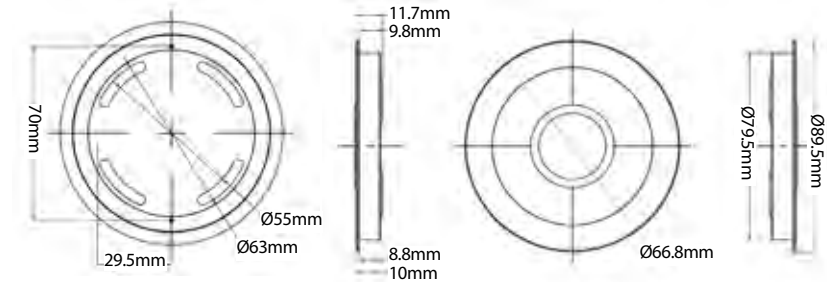

80mm diameter hole cut required

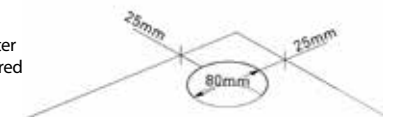

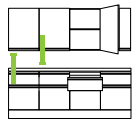

SensioPod >



SensioPod Bluetooth Pull up Socket

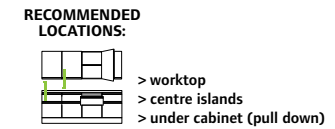

'perfect for the modern living kitchen'

- > The first SensioPod pull up socket with an in-built Bluetooth speaker.
- > Add a touch of luxury to your kitchen designs with this exclusive product.
- > Perfect for an open plan living space which is used for cooking, dining, entertaining and spending time with family.
- > Multi-functional product; power, Bluetooth audio and USB.
- > Two USB ports (with a combined max. allowance of 2100mA) for charging the latest mobile devices.
- > Aluminium casing, slim profile and steel finish top to give a high end look.
- > Specially designed handle makes it simple to pull the fitting up.
- > IP54 rated with inbuilt water channels, protected against splashing water.
- > Quick release catch to guarantee the unit will always close securely.
- > Neon green switch provides a simple means of checking appliances have been turned off when not in use to save on energy bills.
- > Visible plugs and unsightly cables will no longer be seen as the SensioPod can be retracted fully whilst products are still plugged in.



Code	Connection	Features	RRP
SE890920	13A plug included	2 x power sockets, Bluetooth speaker & 2 x USB ports	£175.80

Audio specifications:

- > 2W miniature audio speaker
- > Sensitivity at L/R380MV
- > SNR > 80db
- > Frequency range: 280Hz-16KHz
- > Suitable for use with any Bluetooth enabled audio device and 3.5mm headphone jack (including MP3, MP4, Android Smart phones, iPhone's and iPad).



Please note: if charging a Smart device with a high mA requirement, please only charge one item at any one time.

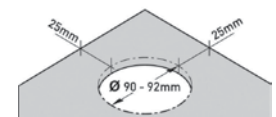

Cut-out Ø90-92mm

SensioPower U Bluetooth Power System with Shelf

FINISH:
aluminium

RECOMMENDED
LOCATION:

CABLE LENGTH:

2.5 metres

'everything you need for the kitchen of today'

- > Add a touch of luxury to your kitchen designs with this exclusive product.
- > Multi-functional product; power, Bluetooth audio, hanging rail and USB.
- > Mount under kitchen wall units.
- > Place your iPad or cookbook on the aluminium hanging shelf when cooking or baking.
- > Two power sockets and Bluetooth audio; plug your appliances in and wirelessly play your music whilst cooking or entertaining through a single device.
- > Perfect for an open plan living space which is used for cooking, dining, entertaining and spending time with family.
- > Two USB ports (with a combined max. allowance of 2100mA) for charging the latest mobile devices.
- > Aluminium finish of the power unit and hanging rail for a high end look.
- > IP54 rated so the product is not affected by splashing water or steam.
- > Neon green switch provides a simple means of checking appliances have been turned off when not in use to save on energy bills.



Code	Connection	Features	RRP
SE891920	13A plug included	2 x power sockets, Bluetooth speaker, 2 x USB ports & hanging shelf	£163.92

Audio specifications:

- > 2W miniature audio speaker
- > Sensitivity at L/R380MV
- > SNR > 80db
- > Frequency range: 280Hz-16KHz
- > Suitable for use with any Bluetooth enabled audio device and 3.5mm headphone jack (including MP3, MP4, Android Smart phones, iPhone's and iPad).



Please note: if charging a Smart device with a high mA requirement, please only charge one item at any one time.

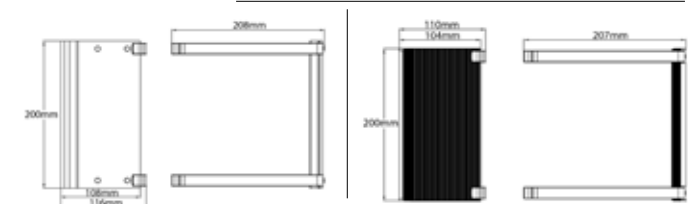
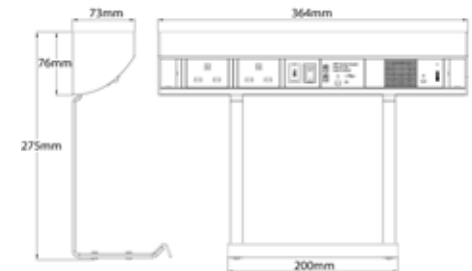

SensioPower R Recessed Power Socket & USB



'flush fit hidden power point'

- > The perfect discreet single socket power solution, perfect if you have minimal void space available below the worktop.
- > Two USB ports for mobile phone & iPod charging.
- > Stainless steel finish top for a high quality finish.
- > Alternatively use this product in the side panel of an island.
- > Neat finish. The lip of the product which sits on top of the work surface is only 5mm.
- > The depth of the steel lid itself is only 1mm.
- > The hinged lid is magnetised and simply lifts up. The lid will remain upright until closed if mounted in a worktop.
- > Illuminated red power icon provides a simple means of indicating whether there is power being supplied to the product.
- > Suitable for use in kitchens, bedrooms or home office.



Code	Finish	Connection	Sockets	RRP
SE890900	Stainless Steel	13A plug included	1 x power & 2 x USB	£74.04

Please note: if charging a Smart device with a high mA requirement, please only charge one item at any one time.

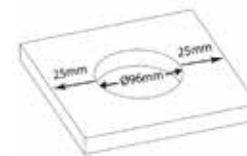
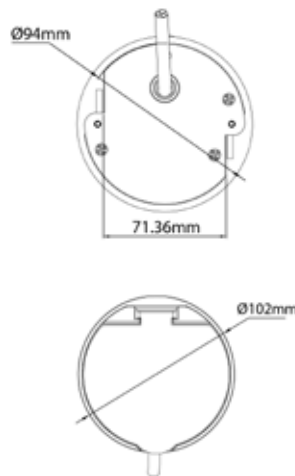

Cut-out Ø96mm



SensioPod >

SensioPod+ Pull up Socket

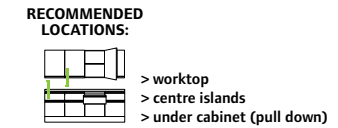
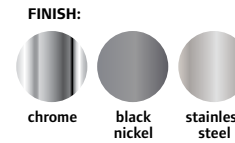

'slim profile, contemporary finishes'

- > Die cast metal top in a choice of three finishes, Chrome, Black Nickel and Stainless Steel.
- > Two USB ports integrated to charge the latest USB devices. The maximum allowance across both USB ports is 2100mA.
- > Aluminium casing and slim profile design.
- > IP54 rated with inbuilt water channels, protected against splashing water.
- > Quick release catch to guarantee the unit will always close securely.
- > Neon green control switch provides a simple means of checking appliances have been turned off when not in use to save on energy bills.
- > Visible plugs and unsightly cables will no longer be seen as the SensioPod+ can be retracted fully whilst products are still plugged in.
- > No need to access the fuse under the plinth should it need changing, as the fuse is built into the model below the on/off switch.



SE80050CH

Code	Finish	Connection	Sockets	RRP
SE80050CH	Chrome	13A plug included	3 x power & 2 x USB	£127.56
SE80050GM	Black Nickel	13A plug included	3 x power & 2 x USB	£127.56
SE80050SS	Stainless Steel	13A plug included	3 x power & 2 x USB	£127.56

Please note: if charging a Smart device with a high mA requirement, please only charge one item at any one time.

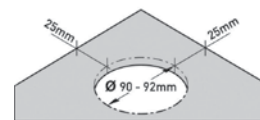

Cut-out Ø90-92mm

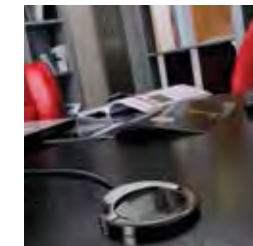
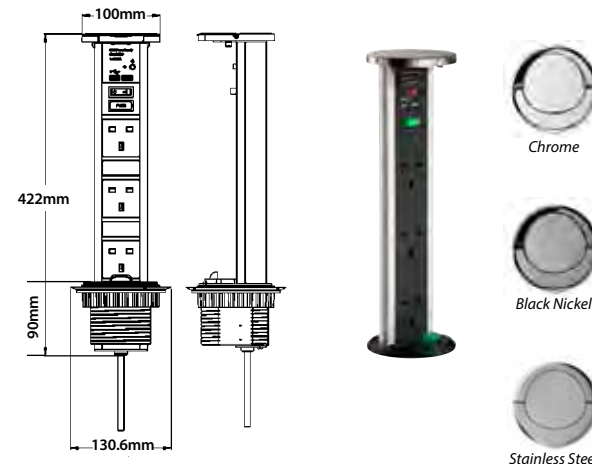

SE80050GM - Black Nickel



SE80050SS - Stainless Steel

SensioPod >

SensioPod Pull up Socket

FINISH:
aluminium

RECOMMENDED LOCATIONS:
> worktop
> centre islands
> under cabinet (pull down)

CABLE LENGTH:
2.5 metres

'great for usb charging'

- > Two USB ports integrated to charge the latest USB devices. The maximum allowance across both USB ports is 2100mA.
- > Slim profile design with aluminium casing.
- > This product has a specially designed chrome handle which makes it simple to pull the fitting up.
- > IP54 rated with inbuilt water channels, protected against splashing water.
- > Quick release catch to guarantee the unit will always close securely.
- > Neon green control switch provides a simple means of checking appliances have been turned off when not in use to save on energy bills.
- > Visible plugs and unsightly cables will no longer be seen as the SensioPod can be retracted fully whilst products are still plugged in.
- > No need to access the fuse under the plinth should it need changing, as the fuse is built into the model below the on/off switch.



Highest mA allowance across the USB's in the UK currently on like-for-like product.

Code	Finish	Connection	Sockets	RRP
SE80050AL	Aluminium Effect	13A plug included	3 x power & 2 x USB	£82.56

Please note: if charging a Smart device with a high mA requirement, please only charge one item at any one time.

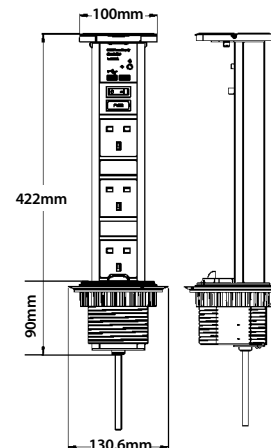
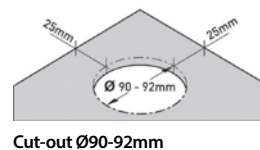

Fuse Cover



IP54 Rated

SensioPod >

SensioPod Eco Pull up Socket

FINISH:



black

RECOMMENDED LOCATIONS:



- > worktop
- > centre islands
- > under cabinet (pull down)

CABLE LENGTH:



2.5 metres

'great value convenience'

- > Economical SensioPod, this version has 3 power sockets only with a neon red on/off switch and quick release catch.
- > Aluminium casing and slim profile design, in-keeping with contemporary design trends.
- > IP54 rated with inbuilt water channels, protected against splashing water.
- > Quick release catch to guarantee the unit will always close securely.
- > Neon red control switch provides a simple means of checking appliances have been turned off when not in use to save on energy bills.
- > Visible plugs and unsightly cables will no longer be seen as the SensioPod can be retracted fully whilst products are still plugged in.
- > No need to access the fuse under the plinth should it need changing, as the fuse is built into the model below the on/off switch.
- > Plastic top with a matt black finish. This product contains a specially designed chrome handle which makes it simple to pull the fitting up.



Code	Finish	Connection	Sockets	RRP
SE80050BK	Black	13A plug included	3 x power	£60.48

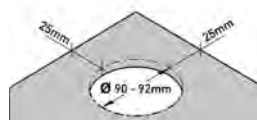

Cut-out Ø90-92mm

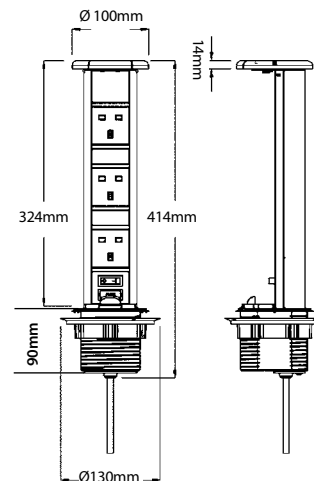

Black



Fuse Cover



IP54 Rated

SensioPod Data Pull up Socket

FINISH:
aluminium effect

RECOMMENDED LOCATIONS:
 > worktop
 > centre islands
 > under cabinet (pull down)
 > Home office
 > Bedroom

CABLE LENGTH:
2.5 metres

'perfect for the home office'

- > Two RJ45 ports for PC/Laptop connectivity. Where wireless internet is not available, the SensioPod™ DATA allows for laptop connection with the home's internet router or network.
- > Aluminium casing and slim profile design, in-keeping with contemporary design trends.
- > Specially designed chrome handle makes it simple to pull the fitting up.
- > IP54 rated with inbuilt water channels, protected against splashing water.
- > Quick release catch to guarantee the unit will always close securely.
- > Neon green control switch provides a simple means of checking appliances have been turned off when not in use to save on energy bills.
- > Visible plugs and unsightly cables will no longer be seen as the SensioPod retracts with items plugged in.



Code	Finish	Connection	Sockets	RRP
SE80060AL	Aluminium Effect	13A plug included	3 x power & 2 x RJ45 ports	£84.84

Dimensions	A	B	C	D	E
SE80060AL	Ø 100mm	424mm	334mm	10mm	130.5mm

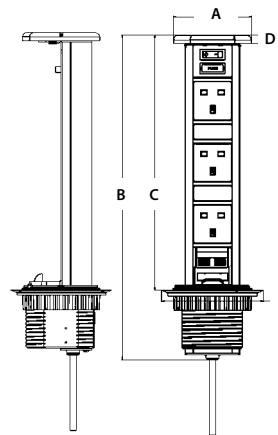
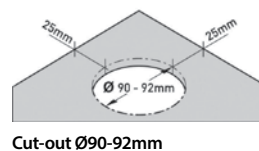

Sensio products for every bedroom...

- 116** Rechargeable Battery Wardrobe Lighting
- 124** Low Voltage Wardrobe Lighting
- 128** LED Reading Lights
- 143** Drivers

Also consider...

- 30** LED Spot Lighting
- 68** Drawer Lighting
- 82** Flexible Strip Lighting
- 92** Integrated Solutions
- 102** Wireless Charging
- 104** Sensiopod
- 132** Lighting Control





The importance of bedroom lighting

A great lighting scheme can really make a difference to the functionality & atmosphere of the bedroom. Consider wardrobe lights and reading lights for practicality, and flexible strip lighting to create a relaxing atmosphere. Here's an example of how Sensio LED lighting can truly transform the bedroom.



Before **sensio** lighting

innovate.
create.
illuminate.™



After **sensio**® lighting



Lithium-ion Battery Wardrobe Lighting >



Innovative Lithium-ion Battery

Use our Rechargeable Lithium-ion battery solutions in wardrobes or kitchen cabinets. Simple, yet extremely effective.

Advantages of our rechargeable battery lighting range

- **No wiring.** No electrical installation required. Can be retrofit by anyone.
- **Simple to maintain.** The battery within these fittings is to be recharged as required using a pluggable USB charger.
- **Low running cost.** The battery only needs to be recharged 2-3 times a year (based on an average usage figure).
- **Flexibility.** The fitting can be placed in any position in the cabinet without having to worry about visible cables or drilling holes for the cable.

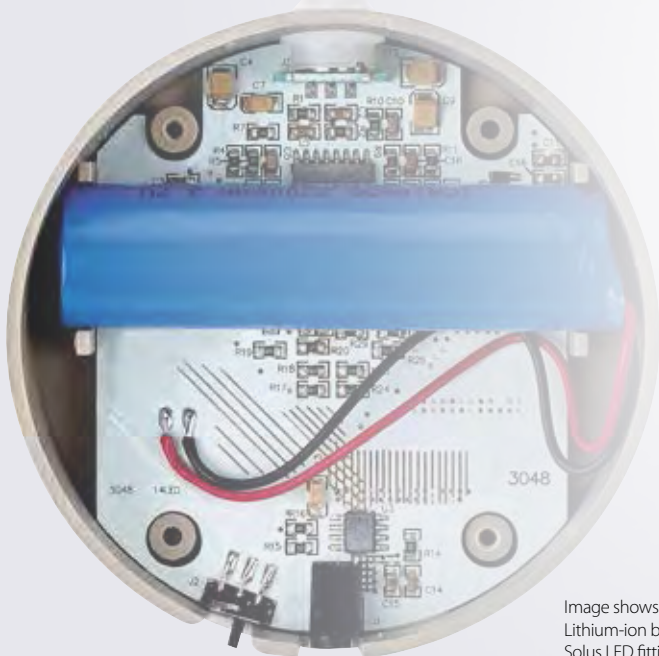

Image shows the rechargeable Lithium-ion battery inside the Solus LED fitting.

Image shows the Solus on charge using the USB outlet on the charger.



About the battery

- Lithium-ion battery
- Rechargeable
- High energy density
- Slow loss of charge when not in use
- Self-discharge rate of approximately 5-10% per month
- The lifespan of all products in this range is 30,000 hours
- Pluggable charger with 5m USB charging cable
- Charging time 5-6 hours on average
- The running time of battery operated products between charging is 8 months on average (based on 2.5 minutes usage per day)

Alto LED Wardrobe Rail Light

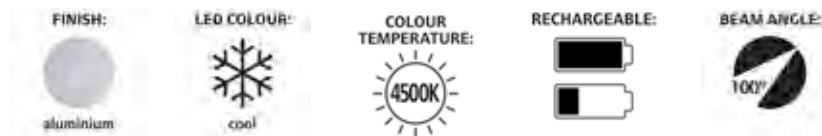

'speed up your morning routine'

- > Aluminium wardrobe rail light with anti-slip design.
- > Features an integrated PIR sensor which automatically switches the light on when the wardrobe door is opened.
- > The PIR will remain on for 30 seconds and then automatically switch off if no movement is detected to ensure there is no power wastage.
- > The rail is available in 10 lengths, most of which can be cut down if required. (The cut lengths stated below are the maximum lengths which can be cut from the left side of the unit)
- > No electrical installation required. Contains a Lithium-ion rechargeable battery.
- > The run time of the product is 6.5 months based on 2.5 minutes of use per day. The charging time is 5.5 hours on average.
- > The LED's in this fitting have a lifespan of 30,000 hours.
- > Recharge the unit using the 03.2005.0800 pluggable USB charger.
- > The maximum weight load of the rail is 20kg.



Code	Wattage	Length	LED Qty	LED Colour	Cut Length	Lumens	RRP
SE20182C1	0.35W	312mm	6pcs	Cool White	N/A	30 lm	£46.08
SE20192C0	0.4W	362mm	7pcs	Cool White	50mm	35 lm	£43.44
SE20202C1	0.45W	412mm	8pcs	Cool White	N/A	40 lm	£60.96
SE20212C1	0.5W	462mm	9pcs	Cool White	50mm	45 lm	£60.96
03.2001.0610	0.6W	562mm	11pcs	Cool White	100mm	55 lm	£59.52
SE20222C1	0.7W	662mm	13pcs	Cool White	200mm	65 lm	£73.92
03.2002.0610	0.8W	762mm	15pcs	Cool White	300mm	75 lm	£72.84
SE20232C1	0.9W	862mm	17pcs	Cool White	400mm	85 lm	£81.36
03.2003.0610	1W	962mm	19pcs	Cool White	500mm	95 lm	£80.64
03.2004.0610	1.2W	1162mm	23pcs	Cool White	600mm	115 lm	£84.96
03.2005.0800	Pluggable USB Charger with 5m USB charging cable						£8.64
03.2006.0603	Top mounting brackets with centre support						£7.56



Pluggable USB Charger
(purchase separately)
03.2005.0800

Side mounting
bracket set included



Top mounting brackets with
additional centre support (sold
separately)



562/762/962/1162mm



PIR sensor
switch

Incline LED Wardrobe Strip Light

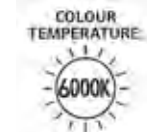
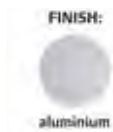

'light angled to prevent glare'

- > Features an integrated PIR sensor which automatically switches the light on when the wardrobe door is opened.
- > The PIR will remain on for 30 seconds and then automatically switch off to ensure there is no power wastage.
- > This fitting is available in 5 standard lengths, however can be cut down if required.
- > No electrical installation required. Contains a Lithium-ion rechargeable battery.
- > The run time of the product is 6.5 months based on 2.5 minutes of use per day. The charging time is 4.5 hours on average.
- > The LED's in this fitting have a lifespan of 30,000 hours.
- > Recharge the unit using the 03.2005.0800 pluggable USB charger.
- > Cool white LED for optimum light output.
- > Suitable for use in a wardrobe or kitchen cabinet.



Code	Length	Wattage	LED Qty	LED Colour	Cut Length	Lumens	RRP
SE20242C0	350mm	0.4W	6pcs	Cool White	N/A	27 lm	£72.60
SE20252C0	550mm	0.6W	10pcs	Cool White	100mm*	48 lm	£74.52
SE20262C0	750mm	0.8W	14pcs	Cool White	300mm*	70 lm	£87.72
SE20272C0	850mm	0.9W	16pcs	Cool White	400mm*	80 lm	£89.64
SE20282C0	950mm	1W	18pcs	Cool White	400mm*	95 lm	£92.76

Accessories

03.2005.0800	Pluggable USB Charger with 5m USB charging cable	£8.64
--------------	--	-------

* Maximum cut length. An equal amount has to be cut from each end of the fitting. (Except the SE20282C0, 250mm is to be cut from the left and 150mm from the right).



Pluggable USB Charger (purchase separately) 03.2005.0800

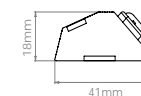
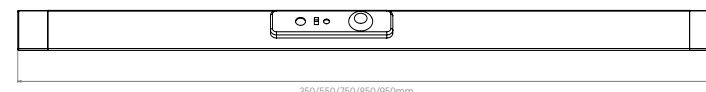

Lithium-ion Battery Wardrobe Lighting >

Solus Angled LED Wardrobe Spot Light



'so simple to install and maintain'

- > Contains a rechargeable Lithium-ion battery. No electrical installation required.
- > The product is cable free for ease of installation.
- > Rechargeable via a pluggable USB charger.
- > Angled surface light to reduce glare.
- > Features an integrated PIR sensor which automatically switches the light on when the wardrobe or cabinet door is opened.
- > The detection range of the PIR is 2m, meaning the fitting can be positioned as required inside the wardrobe.
- > The run time of the product is 8 months based on 2.5 minutes of use per day. The charging time is 6.5 hours on average.
- > The perfect fitting for use inside wardrobes with several storage compartments.
- > The product has an additional on/off switch for optional use.
- > Suitable for use in a wardrobe or kitchen cabinet.



Can be used in the kitchen as well as the bedroom

Code	Wattage	LED Qty	LED Colour	Quantity	Lumens	RRP
SE20061C0	0.7W	14pcs	Cool White	1	52 lm	£38.52
SE20061C3	2.1W	14pcs (PF)	Cool White	3	52 lm (PF)	£126.24

Accessories		
SE2007000	Pluggable USB Charger with 5m cable	£10.68

PF - per fitting

Pack includes 3 fittings and a USB charger.

Surface mounted with integrated PIR



Charging point & on/off switch



Rechargeable battery via USB Charger.
Charge using the plug provided or via the USB cable (using a laptop for example).

Red indicator light shows that the unit is charging.

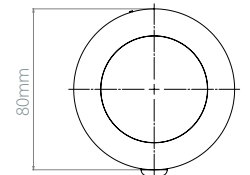

Mounting bracket included for installation

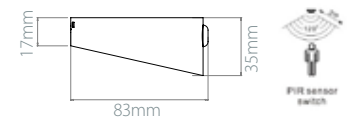

Mimas LED Wardrobe Light



'lighting just where you need it'

- > Contains a rechargeable Lithium-ion battery. No electrical installation required.
- > The product is cable free for ease of installation.
- > An ideal product for bedroom wardrobes or cabinets.
- > Features an integrated PIR sensor which automatically switches the light on when the wardrobe/cabinet door is opened.
- > The PIR will remain on for 30 seconds and then automatically switch off if no movement is detected to ensure there is no power wastage.
- > The PIR has a detection range of 2m, allowing you to place the fitting where you require in the wardrobe/cabinet.
- > The run time of the product is 8 months based on 2.5 minutes of use per day. The charging time is 6.5 hours on average.
- > Recharge the unit using the pluggable USB charger.
- > The product has an additional on/off switch for optional use.



Use in a kitchen wall unit as well as a wardrobe

Code	Wattage	LED Qty	LED Colour	Qty	Lumens	RRP
SE20051C0	0.7W	14pcs	Cool White	1	52 lm	£46.92
SE20051C3	2.1W	14pcs (PF)	Cool White	3	52 lm (PF)	£152.16

Accessories

SE2007000	Pluggable USB Charger with 5m cable	£10.68
-----------	-------------------------------------	--------

PF - per fitting

Pack includes 3 fittings and a USB charger.



Charging point & on/off switch



Pluggable USB Charger
(purchase separately)
SE2007000

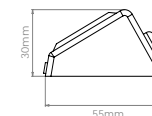

Mounting bracket included for installation

Prisma Tiltable LED Wardrobe Light



'angle the light as you need it'

- > Contains a rechargeable Lithium-ion battery.
- > No electrical installation required. The fitting is cable free for simple installation. Anyone can install.
- > Rechargeable via a pluggable USB charger.
- > Contains a tiltable LED centre. Angle the light to the position you require.
- > Has an integrated PIR sensor which automatically switches the light on when the wardrobe or cabinet door is opened.
- > The charging time of this product is only 3 hours.
- > This fitting is also great for use in kitchen cabinets or a pantry.
- > The LED's in this fitting have a lifespan of 30,000 hours.
- > This is the most discreet rechargeable solution – it has the slimmest profile.
- > Fitting can be retrofit.



Code	Wattage	LED Qty	LED Colour	Quantity	Lumens	RRP
SE20230W0	0.5W	8pcs	Cool White	1	57 lm	£32.52

Accessories

SE2007000	Pluggable USB Charger with 5m cable					£10.68
-----------	-------------------------------------	--	--	--	--	--------

Surface mounted with integrated PIR



Charging point & on/off switch



Rechargeable battery via USB Charger.
Charge using the plug provided or via the USB cable
(using a laptop for example).



Pluggable USB Charger
(purchase separately)
SE2007000

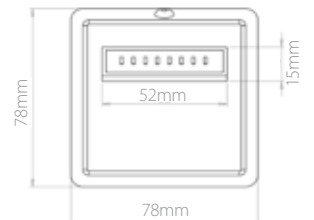

Mounting bracket included for installation

Lithium-ion Battery Lighting >

Orion LED Under Bed Light



'illuminates the floor as motion is detected'

- > Comes with a rechargeable Lithium-ion battery pack.
- > No electrical installation required. Anyone can install.
- > Recharge the battery pack using the pluggable USB charger.
- > Simple to install, the Orion has an adjustable hinge which is simply to be screwed to the underside of the bed.
- > PIR sensor integrated. When the product is mounted on the edge of the bed the sensor will detect movement from a 2m range and will project a beam of light across the floor.
- > The LED's in this fitting have a lifespan of 30,000 hours.
- > The fitting has an on/off switch on it's right end so can be switched off when use is not required.
- > This product is also suitable to be mounted in wardrobes or kitchen cabinets.



Code	Wattage	LED Qty	LED Colour	Finish	Lumens	RRP
SE20292W0	0.4W	6pcs	CoolWhite	Aluminium	32 lm	£39.96

Accessories

SE2007000	Pluggable USB Charger with 5m cable					£10.68
-----------	-------------------------------------	--	--	--	--	--------

Integrated PIR & Rechargeable Battery Pack



Pluggable USB Charger (purchase separately) SE2007000



Rechargeable Battery Pack

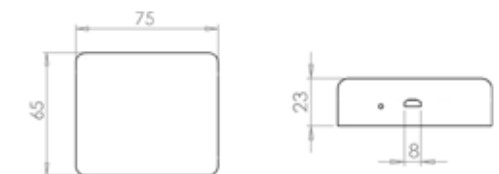



Low Voltage Wardrobe Lighting >



Elara LED Wardrobe Rail Light

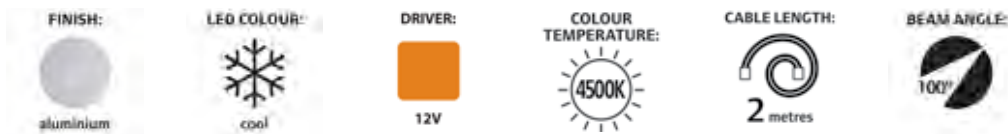

'lighting truly integrated into your wardrobe'

- > Aluminium wardrobe rail light.
- > Features an integrated PIR sensor which automatically switches the light on when the wardrobe door is opened.
- > The PIR will remain on for 30 seconds and then automatically switch off if no movement is detected to ensure there is no power wastage.
- > The rail is available in 4 standard lengths, however can be cut down from the left side if required. Ensure you leave 100mm from the left side of the sensor and the remaining length can then be cut as required.
- > Contains a soft rubber strip to prevent items from slipping on the rail.
- > The maximum weight load of the rail is 20kg.
- > Side mounting brackets provided.
- > The advantages of the Elara over the Alto are; the higher light output and no maintenance is required (no requirement to recharge).

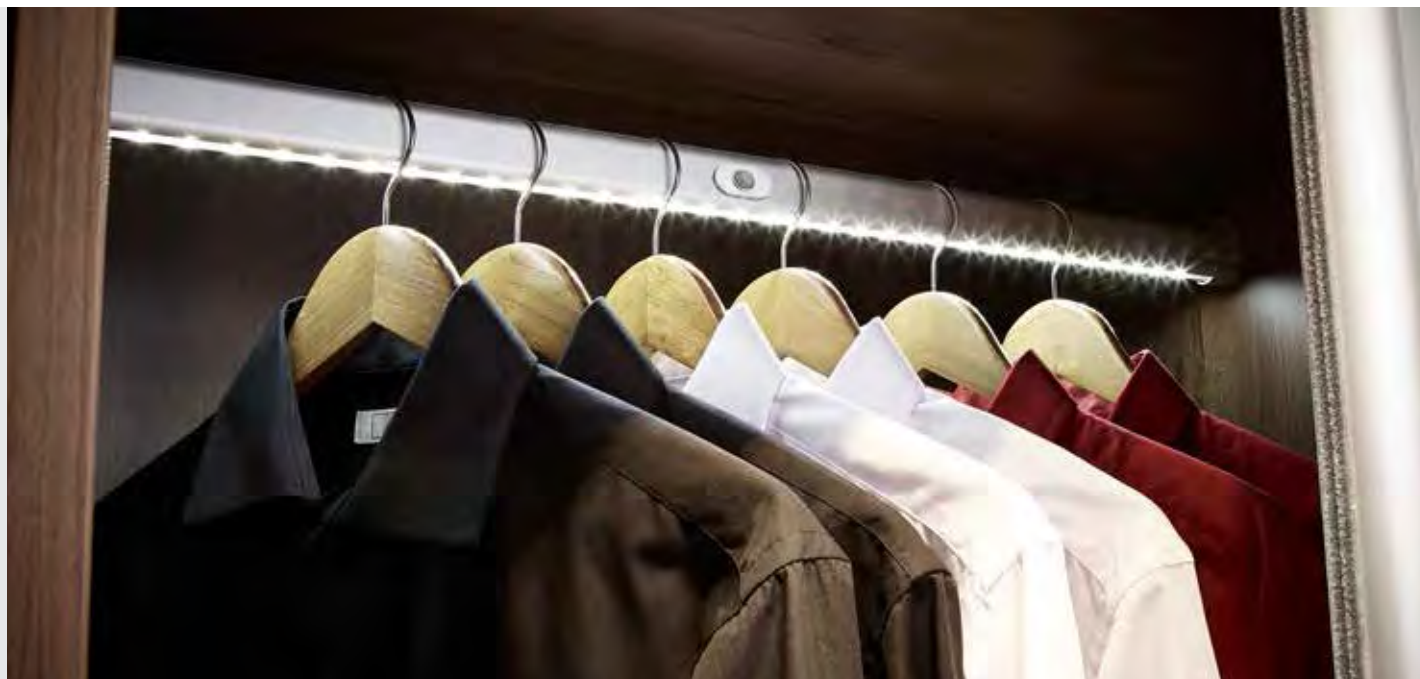

Code	Wattage	Length	LED Qty	Cut Length	Lumens	Driver	RRP
SE20011C0	1.9W	562mm	24pcs	100mm*	110 lm	■	£43.08
SE20021C0	2.6W	762mm	36pcs	300mm*	132 lm	■	£47.88
SE20031C0	3.2W	962mm	45pcs	300mm*	152 lm	■	£56.52
SE20041C0	3.9W	1162mm	54pcs	400mm*	170 lm	■	£61.44

* Cut length refers to the amount which can be cut from each fitting. Keep 100mm from the left side of the PIR sensor switch, the remaining length on the left side can be cut.

Accessories

03.2006.0603	Top Mounting Brackets with Centre Support	£7.56
SE9009	2.5m Extension Cable	£2.16
Driver (for more drivers see page 143)		
SE40625	6W LED Driver with 4 Port JB4 Distributor	£15.12

Built-in PIR



Side mounting bracket set included



Top mounting brackets with additional centre support sold separately

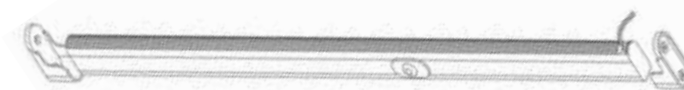

10mm hole required to feed the cable & JB4 plug

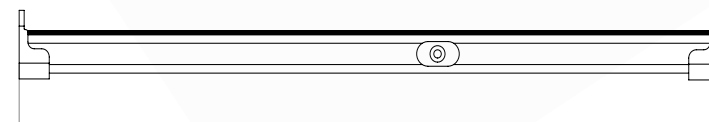

562/762/962/1162mm

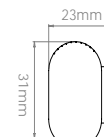

PIR sensor switch

Operio Mini LED Wardrobe Light

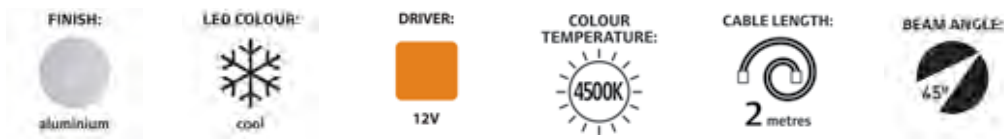

'small and discreet, side or top mount'

- > Surface mounted product for simple installation.
- > Fit at the top of a wardrobe/cabinet or at the side as pictured to throw light across the width of the wardrobe.
- > Compact design for a discreet lighting solution.
- > Contains an integrated PIR sensor switch, so the light will switch on when the wardrobe/cabinet door is opened.
- > The PIR has a detection range of 2m so the fitting can be positioned in the wardrobe as required.
- > The LED's in this fitting are concealed.
- > The curved aspect of the fitting means the light is dispersed evenly and is directed back into the wardrobe/cabinet as required.
- > High light output, low energy consumption.
- > Each 120mm fitting runs at only 1.2W.



One Operio Mini is fit at either side of this corner unit to flood the wardrobe with light

Code	Wattage	LED Qty	LED Colour	Qty	Lumens	Driver	RRP
SE20081C0	1.2W	3pcs	Cool White	1	28 lm		£29.28
SE20081C2	2.4W	3pcs (PF)	Cool White	2	28 lm (PF)	Included	£74.04

PF - per fitting

Pack includes 2 fittings and one 6W driver.

Accessories

SE9009	2.5m Extension Cable	£2.16
--------	----------------------	-------

Driver (for more drivers see page 143)

SE40625	6W LED Driver with 4 Port JB4 Distributor	£15.12
---------	---	--------

Integrated PIR



Concealed LED's

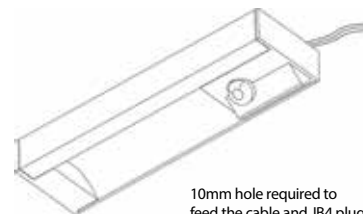

10mm hole required to feed the cable and JB4 plug

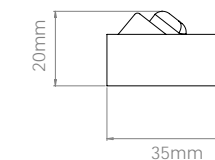
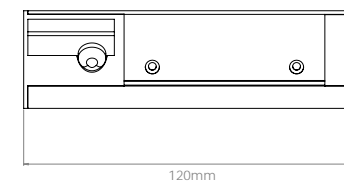

Operio Wardrobe Light

FINISH:  aluminium	LED COLOUR:  cool	DRIVER:  12V	COLOUR TEMPERATURE:  4500K	CABLE LENGTH:  2 metres	BEAM ANGLE:  65°
--	---	--	--	---	--

'two sensors for left & right doors'

- > Contains 2 integrated PIR sensor switches, so the light will switch on no matter which side of the wardrobe is opened.
- > The PIR has a detection range of 2m so the fitting can be placed in the centre of the wardrobe and will still detect the door opening.
- > Surface mounted product for simple installation.
- > The LED's in this fitting are concealed.
- > The curved aspect of the fitting means the light is dispersed evenly and is directed back into the wardrobe/cabinet as required.
- > The LED's in this fitting have a lifespan of 30,000 hours.
- > High light output, low energy consumption.
- > Each 400mm fitting runs at only 2.2W.



Code	Wattage	LED Qty	LED Colour	Finish	Lumens	Driver	RRP
SE20111C0	2.2W	30pcs	Cool White	Aluminium	100 lm		£47.88

Accessories

SE9009	2.5m Extension Cable						£2.16
--------	----------------------	--	--	--	--	--	-------

Driver (for more drivers see page 143)

SE40625	6W LED Driver with 4 Port JB4 Distributor						£15.12
---------	---	--	--	--	--	--	--------

Surface mounted with 2 x PIR switches



Concealed LED's

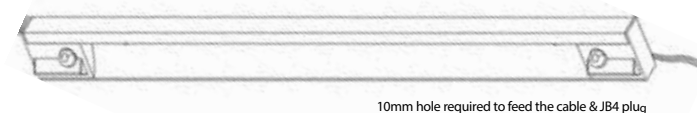

10mm hole required to feed the cable & JB4 plug

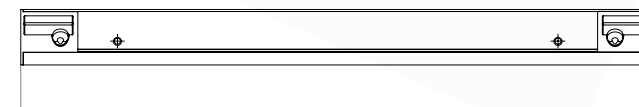

400mm

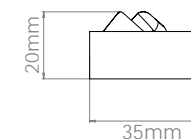

20mm

35mm



PIR sensor switch



LED Reading Lights >



Opus LED Reading Light

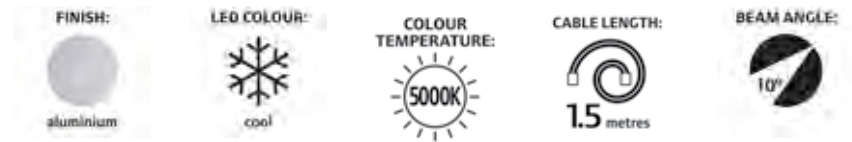

'one high power LED for the brightest output'

- > This fitting contains one high power LED, the brightest of the Sensio reading light range.
- > Built-in driver for ultimate ease of installation.
- > The 350mm flexible arm makes it simple to adjust the position of the light.
- > The fitting has a small push switch on the top of the light head, making it simple to switch the light on/off as required.
- > Low energy consumption. Each fitting runs at only 1.7W.
- > The 10 degree beam angle means the light source is very direct.
- > The small size of the light head makes for a discreet but powerful task light.
- > Quick and simple to install. Either hard-wire or connect to a 3-pin plug top and connect directly to the mains supply with no need for an external driver.



Code	Wattage	LED Qty	Qty per pack	Lumens	RRP
SE20121C0	1.7W	1pc	1 light	66 lm	£46.44
SE20121C2	1.7W (PF)	1pc (PF)	2 lights	66 lm (PF)	£92.88

PF - Per Fitting

On/off switch integrated



Built-in driver

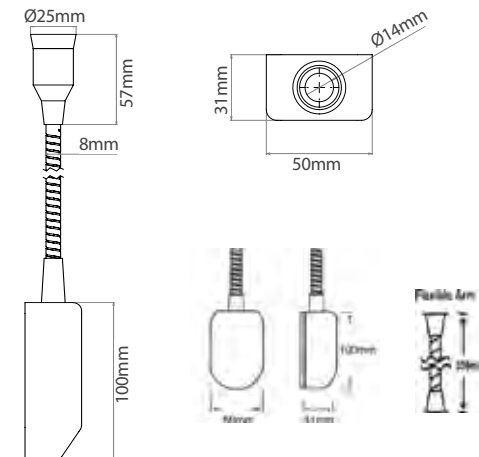

Flecto LED Reading Light

FINISH:  aluminium	LED COLOUR:  cool	COLOUR TEMPERATURE:  5000K	CABLE LENGTH:  1.5 metres	BEAM ANGLE:  140°
--	---	--	---	---

'in-built driver for ease of installation'

- > The long head of the lamp and 140 degree beam angle allows for greater dispersion of the light.
- > Built-in driver for ultimate ease of installation.
- > The 350mm flexible arm makes it simple to adjust the position of the light.
- > The fitting has a small push switch on the end of the light head, making it simple to switch the light on/off as required.
- > Extremely low energy consumption. Each fitting runs at only 1.6W.
- > Quick and simple to install. Either hard-wire or connect to a 3-pin plug top and connect directly to the mains supply with no need for an external driver.



Code	Wattage	LED Qty	Qty per pack	Lumens	RRP
SE20131C0	1.6W	9pcs	1 light	32 lm	£41.28
SE20131C2	1.6W (PF)	9pcs (PF)	2 lights	32 lm (PF)	£82.68

Built-in driver

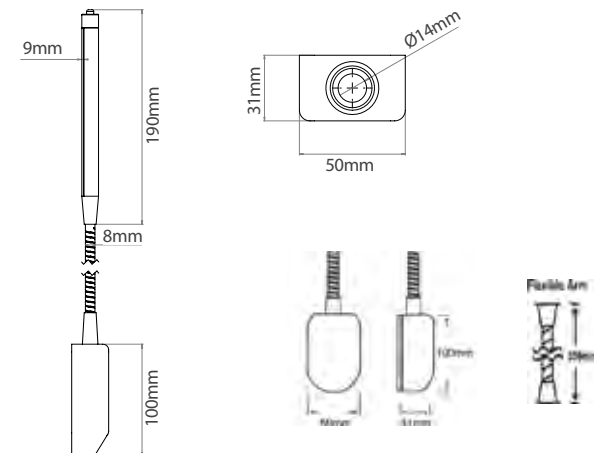

Tactus LED Reading Light

FINISH:  aluminium	LED COLOUR:  cool	DRIVER:  12V	COLOUR TEMPERATURE:  5000K	CABLE LENGTH:  1.5 metres	BEAM ANGLE:  80°
--	---	--	--	---	--

'touch on/off functionality built-in'

- > Touch on/off function. Touch the fitting to switch the light on/off.
- > The 25cm flexible arm allows the fitting to be positioned as required.
- > The bracket on the fitting is adjustable, meaning the reading light can be positioned on either side of the bed.
- > 19 cool white LED's integrated for optimum light output.
- > Low energy consumption, each fitting runs at only 1.4W.
- > The 25,000 hour lifespan of the fitting means if used for 2 hours every day it would last 34 years before a replacement fitting was needed.
- > 12V fitting.
- > Includes screws for installation.



Code	Wattage	LED Qty	Qty	Lumens	Driver	RRP
SE30155AL	1.4W	19pcs	1	40 lm		£36.84
SE30155ALK2	1.4W (PF)	19pcs (PF)	2	40 lm (PF)	Included	£88.92

Driver	(for more drivers see page 143)	RRP
SE40625	6W LED Driver with 4 Port JB4 Distributor	£15.12

PF - Per Fitting

Touch on/off function.
Touch the fitting to switch the light on/off.

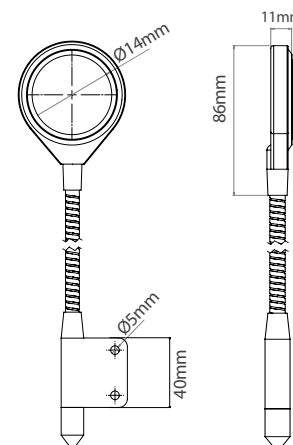

Touch on/off function

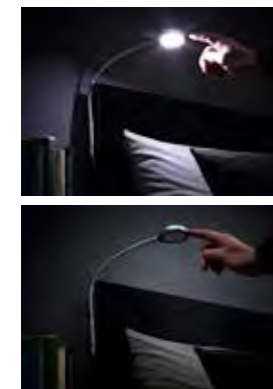

Lighting Control >



LED Dimming Remote Control

'dimming and switching for all areas of lighting'

- > Create or choose the lighting level that is perfect for you at the touch of a button.
- > Multiple functions of the dimmer:
 - Dim to the lowest light level - press the left hand button once.
 - Set to full brightness - press the right hand button once.
 - Select the desired light level by turning the dial.
 - On/off switching - press the middle button.
- > Memory function of the performance before last switched off.
- > There is no limit on the number of receivers which can be controlled via one remote control. All receivers within a 15m range of the remote can be controlled via a single remote.
- > One receiver is required for each driver (connected to the lights you wish to control).
- > Suitable for single colour LED lighting only.



Multiple receivers can be run from 1 dimming remote control

Code	Product Description	Max Wattage	Driver	RRP
SE790050	LED Dimming Receiver	30W (orange) or 60W (green)	orange green	£38.88
SE793090	LED Dimming Remote Control	n/a	orange green	£30.12



LED Dimming Remote Control

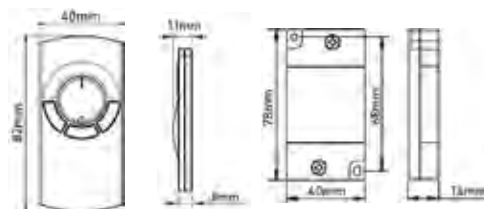

Driver(s) to be purchased separately

Sensio Multi-Light Mobile Lighting Control

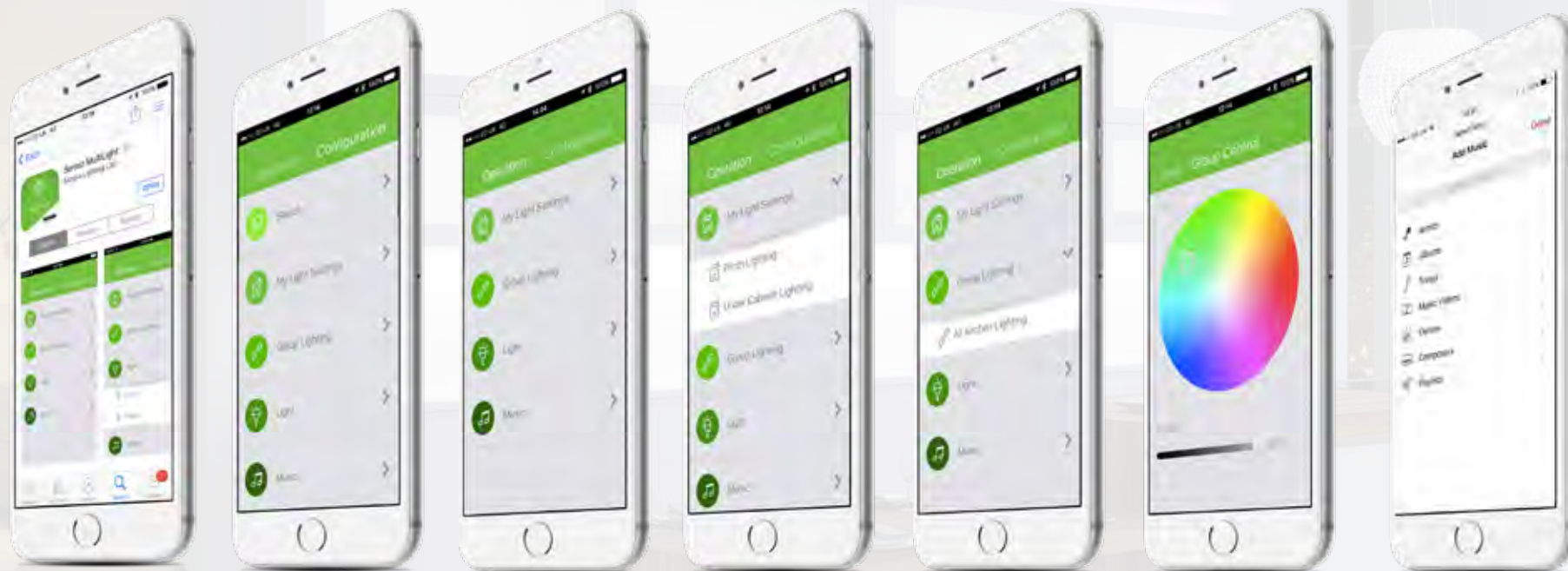

■ Multiple light type control (single colour, RGB, DuoFlex)

■ Simple installation, now or later (can be retrofit)

■ Easy to use FREE iOS App

■ No more remotes, control all lighting from one App

Sensio Multi-Light App Bluetooth Receivers

'control Sensio lighting from your mobile device'

> Control any Sensio lighting product which requires a 12/24V Sensio driver from an Apple mobile device.

> How it works:

- Simply plug the relevant type of receiver for your lighting (single colour, RGB or Duo Colour) into your drivers. A receiver is required for each driver which is connected to lighting you'd like to control from the App.
- Download 'Sensio Multi Light' from the Apple App store (free to download).
- Switch all lighting to be controlled via the App on.
- Follow the Sensio instructions to simply configure your preferred settings.

> Features:

- On/off switching of connected lights
- Single product selection - choose to control each type/area of lighting individually
- Group lighting - group all/some of your lighting to be controlled together
- Your settings - set-up lighting area's and control each area separately
- Music - colour changing lighting will change to the sound of your music



Code	Product Description	Max Wattage	Driver	RRP
SE792990	Bluetooth Receiver - Single Colour LED	36W () or 72W ()	() ()	£26.28
SE793990	Bluetooth Receiver - RGB LED	36W () or 72W ()	() ()	£30.12
SE794990	Bluetooth Receiver - Duo Colour LED	72W ()	()	£28.92

Driver(s) to be purchased separately

Detection range of the receivers is ≤10m

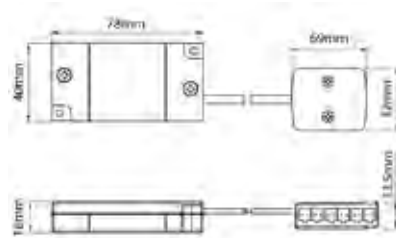

Single colour LED - 12 ports

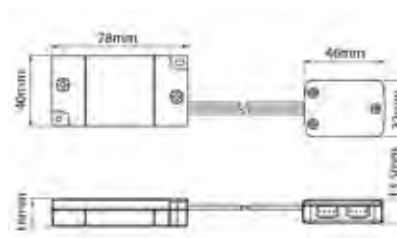

RGB & DuoFlex - 4 ports

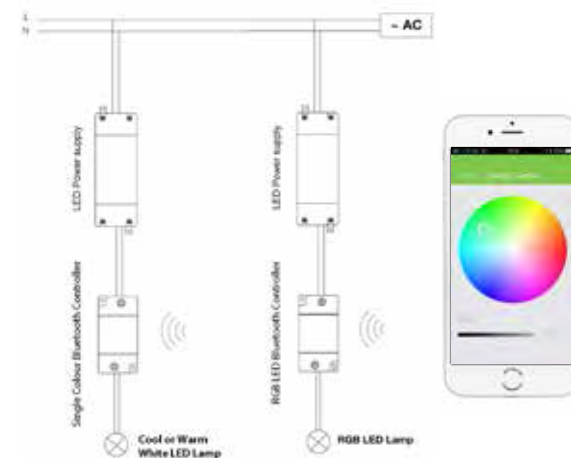

Dual-function sensors >

Cannon Cabinet/Swipe Sensor Switch

FINISH:
aluminium

CABLE LENGTH:
1.5 metres

'activate lights with motion'

- > Can be used with 12V & 24V products (without an integrated sensor).
- > Works as an on/off switch for these fittings.
- > Two functions of the sensor:
 - Mount inside a cabinet – open door to activate light.
 - Mount under cabinet – lights are activated when a hand passes before the sensor.
- > 5cm detection range, so unwanted detection is not a problem.
- > Can be surface mounted or recessed into a pelmet.
- > Plug and play, and no additional wiring is required by the electrician.
- > The product is preset to the Monostable function.
- > Infra-red sensor for use with LED lighting.
- > 1 x JB4 Distribution Block supplied with each sensor.



Code	Max Wattage	Cut out:	Detection range	Driver	RRP
SE40516	15W (orange) or 30W (green)	14mm	5cm	orange green	£18.24

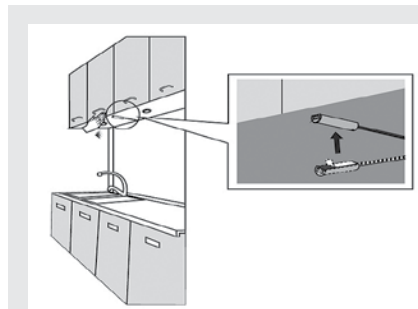

Bistable function

For under cabinet mounting.

1. Move your hand over the sensor (within a 5cm range) to switch the connected lights on.
2. Move your hand over the sensor once more to switch the connected lights off.

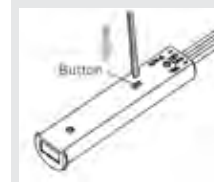

Function set:

1. To set the function, first connect to the power supply.
2. Pressing the button switches the function from one to the other.

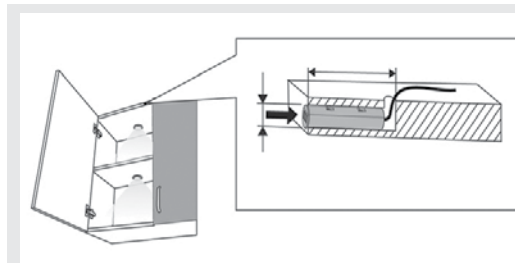

Monostable function

For internal cabinet mounting.

1. Open the cabinet door to switch the connected lights on.
2. Close the cabinet door to switch the connected lights off.

Connect to driver

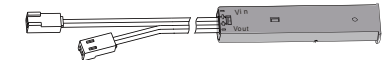

Connect to distribution block supplied.
Connect up to 5 lights to this block

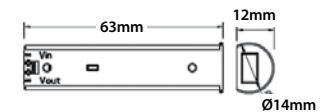

Moda LED Dimming Sensor Switch

FINISH:
aluminium

CABLE LENGTH:
1.5 metres

'3 functions including dimming'

- > Multi-functional product.
- > The SE40520 has 3 functions; use as a dimmer, external on/off switch or in-cabinet on/off switch for 12V & 24V LED products.
- > Attractive product, perfect for contemporary kitchens.
- > Use with any 12V or 24V Sensio product (without an integrated sensor).
- > Aluminium effect finish to match many of our best selling products.
- > Plug and play, and no additional wiring is required by the electrician.
- > IR Sensor with a 5cm detection range (swipe on/off function).
- > Memory function of the last setting before the lighting was switched off.
- > 1.5m cable from the sensor to the JB4 plug and 1.5m from the sensor to the 6 port JB4 distribution block.



Code	Max Wattage	Detection range	Driver	RRP
SE40520	15W (orange) or 30W (green)	5cm	orange green	£16.08

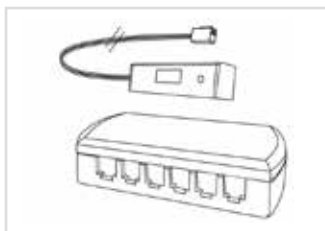

Extremely simple connection system. The JB4 plug from the sensor connects to the LED driver and the lights connect to the distribution block on the sensor.

Operation:
The SE40520 sensor has three functions.



Under cabinet - The lights are activated by a hand swipe across the sensor and deactivated the same way.

In Cabinet - The lights are activated by the opening of a cabinet door and deactivated once the door closes.

Dimming - Hold your hand in front of the sensor to dim the lights. The lights will dim/brighten in increments of 10%. Remove your hand once the desired brightness level is achieved.

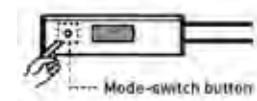

Once a power source is connected a red indicator light within the sensor will illuminate when the lights are off.

This fitting can be used under a cabinet or inside a cabinet. To switch the function of the sensor press the mode-switch button.

A maximum of 11 products can be connected to the Moda (unless daisy chained).

SE40520 - Dimming Sensor Switch

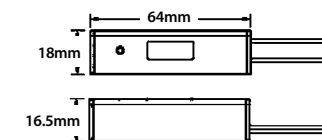



250W Infra-red Sensor Switch

'activate your lights with motion'

- > Maximum detection range: 5-10cm, to ensure the sensor is not activated when not required. Swipe hand past the sensor to activate lights.
- > Can be used with; 12V, 24V or 240V fittings.
- > Suitable to use with the majority of Sensio fittings.
- > The motion sensor detects body heat motion and automatically switches the lights on or off.
- > High wattage of 250W means the sensor will run a large number fittings.
- > Rated input voltage: AC100-240V.
- > Discreet fitting, sits almost flush to the furniture with a cut-out of only 13mm required.



Code	Max Wattage	Cut out:	Cable length:	Detection range	Driver	RRP
SE40517	250W	13mm	2m	5-10cm		£25.32

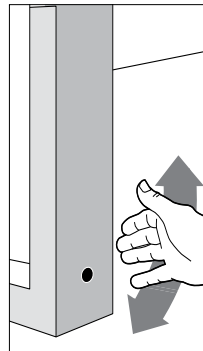

Recess into the side panel of a kitchen cabinet. A hand swipe will switch all connected lighting on/off.

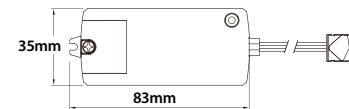
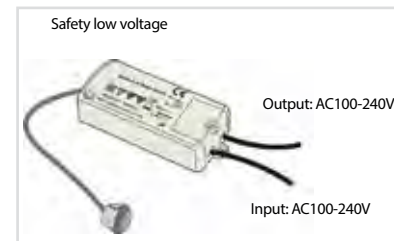

In Cabinet PIR Sensor Switch

FINISH:
aluminium

CABLE LENGTH:
1.5 metres

'discreet in-cabinet motion sensor switch'

- > Suitable to be used with 12V or 24V products without an integrated sensor. The SE40515 can also be used with 240V products.
- > Works as an on/off switch for lighting installed inside cabinets or wardrobes. Mount in a side panel or back panel of an internal unit.
- > Small and discreet product.
- > On the SE2015000, the sensor has a 1.5m cable to the sensor, a 300mm cable with JB4 plug to connect to the driver and a 4 port JB4 distribution block for extremely simple plug and play connection. The SE40515 does not have any JB4 connectors.
- > A dial on the front of the sensor unit allows you to select the time delay on the sensor (from 10 seconds to 3 minutes).
- > 80° detection angle.
- > 0.5m - 2.5m detection range.



Code	Max Wattage	Detection range	Driver	RRP
SE2015000	30W (orange) or 60W (green)	0.5-2.5m	orange green	£25.32
SE40515	250W	0.5-2.5m	orange green or 240V	£26.16

Connect the 300mm cable with JB4 connector to your driver.
Plug your lights into the 4 port distribution block on the sensor.

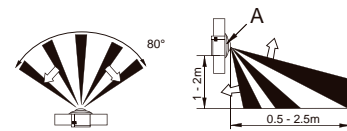

Top View

Side View
Part A should be positioned parallel to the floor.

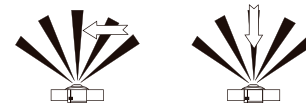

Good Sensitivity

Poor Sensitivity

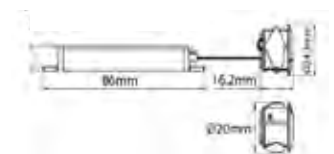
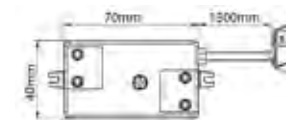

250W In-Cabinet IR Sensor Switch

CABLE LENGTH:



'door sensor switch to activate your lights'

- > Detection range of 5-10cm. Recess into internal shelves in wall units or wardrobes. When the door is opened all connected lighting will be switched on and switched off when the door closes.
- > Can be used with; 12V, 24V or 240V fittings which do not have an integrated switch or sensor.
- > High wattage of 250W means the sensor will run a large number fittings.
- > The light(s) will switch on once the door opens as the sensor detects that the door is no longer blocking its path and they'll be switched off once the door is closed.
- > Very discreet switching option, especially in darker furniture.
- > Can be used in kitchens or bedrooms.



Code	Max Wattage	Cut out:	Cable Length	Detection range	Driver	RRP
SE40518	250W	13mm	2m	5-10cm		£25.32

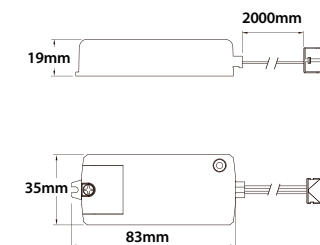
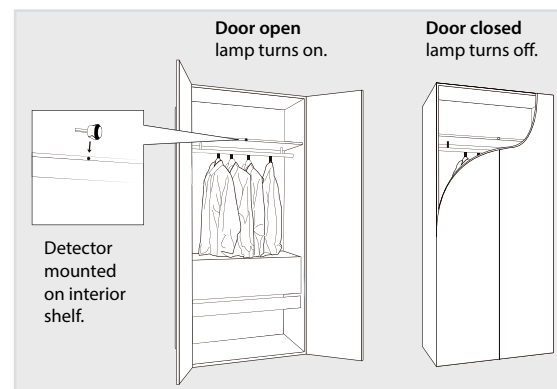

Cable connect system

Changing LED light fittings couldn't be simpler!
The Sensio cable connect system enables light fittings to be easily changed without the need to access or remove existing cabling.

Save time and money with the Sensio cable connect system

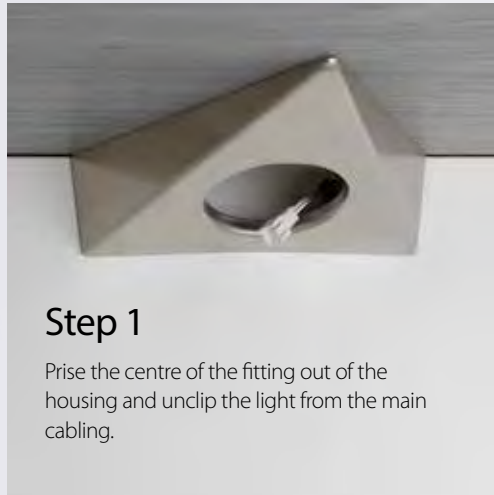

Features & benefits:

- > No need for a fitter if you wish to change or replace an LED fitting as the cabling does not need to be accessed or pulled through from behind the cabinet.
- > Lamps can be changed by anyone.

- > Available on HD LED under cabinet spot light products.
- > Each fitting has a 2.5m cable. The lamp has a 35mm cable with JB4 plug which connects to the main run of cable.

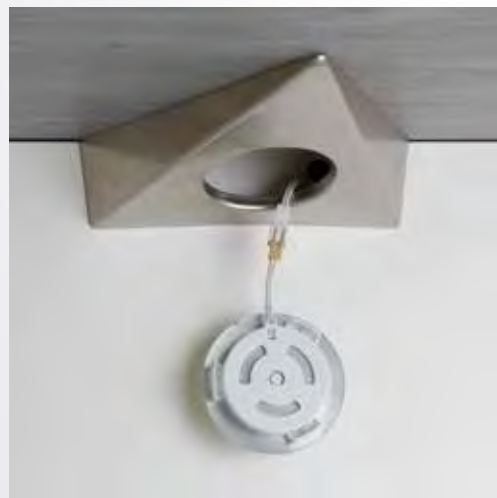

Step 2

Clip the JB4 connector on the end of the new fitting into the adapter on the main cabling.



Step 3

Push the LED fitting into the lamp housing.

Connecting by colour

Sensio's colour coding system makes ordering everything required for your lighting design that little bit simpler.

To simplify the process of selecting the appropriate driver for your lighting requirements, Sensio use a simple colour coding system. The cable on the light fitting, the distributor block on the driver and the outer packaging for each product all carry a colour-coded label.

- > All **components** are **colour coded**.
- > The **packaging** is **colour coded**.
- > The **cable** on the product (above the connection plug) is **colour coded**, this ensures that there is no danger of connecting a product to a driver of the incorrect voltage.
- > The **wattage of the driver is also indicated on the block** so when connecting fittings you can be sure not to exceed the wattage allowance of the driver.

All components and even the packaging is colour coded.



All drivers featured in this brochure are coded with a small coloured square. Simply refer to the product table opposite to find the colour that is correct for your lights.

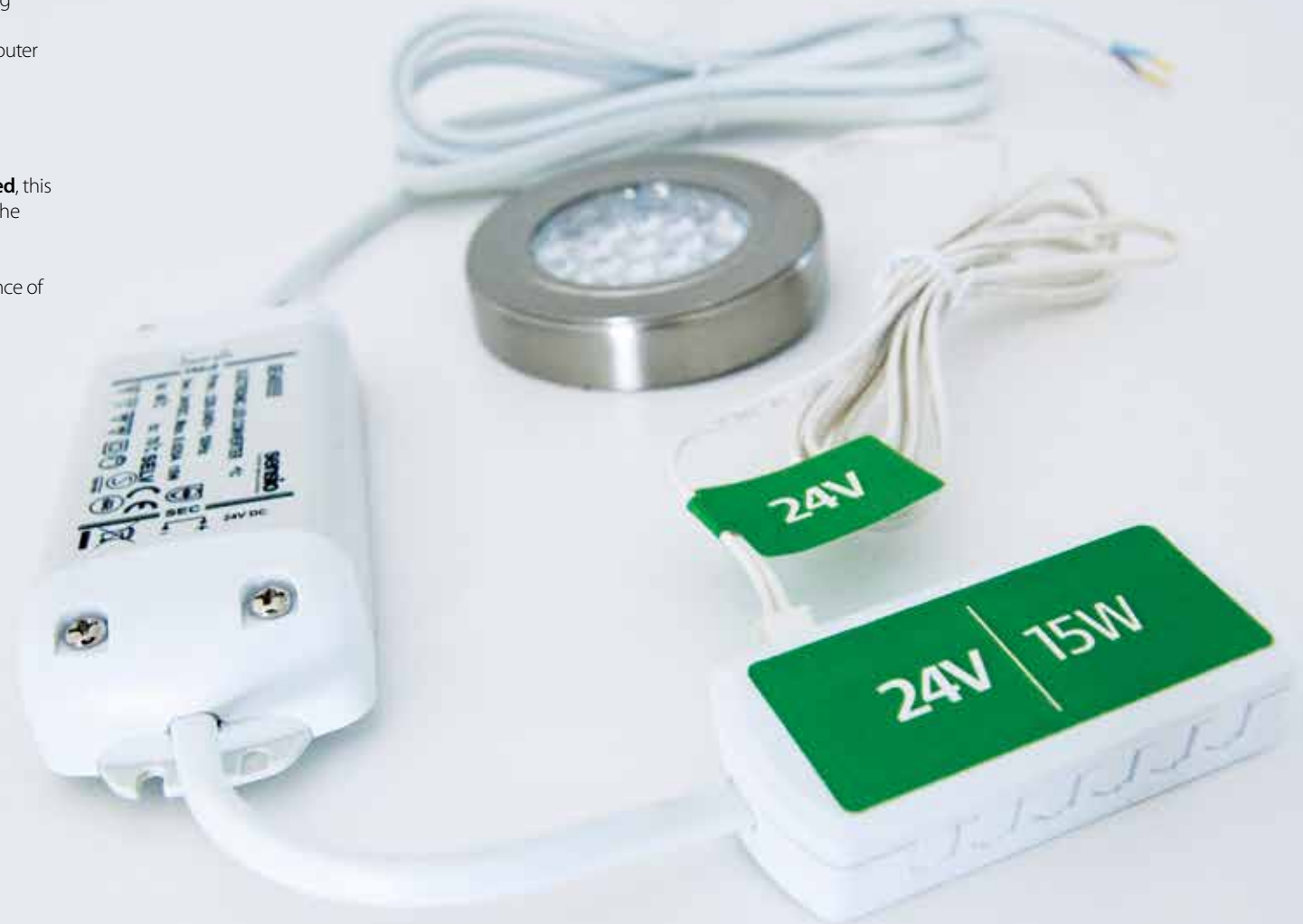

Drivers

How to select the right driver for your lights:

1. All **drivers** in this brochure are **colour coded**. Refer to the product table to find the colour that is correct for your lights.
2. Each driver can run a number of lights. Simply **divide the wattage of the driver by the wattage of a single light** and this will tell you exactly how many lights can be run by the driver.

Example:
15W driver with 3W lights
 $15 \div 3 = 5$ lights

3. **Sensio drivers are available in various wattages** e.g. 15W and 30W. Simply work out the best option dependent on the number of lights you have.

Note: Drivers have a limited number of ports where lights are connected. A driver with 12 ports is therefore limited to a maximum of 12 lights. See the table for the number of ports.

Code	Description	Colour Coding	Dimensions (LxWxD)	RRP
SE40625	6W Driver with 4 Port JB4 Distributor	■	52x34x20mm	£15.12
SE40525	15W Driver with 6 Port JB4 Distributor	■	120x45x20mm	£20.52
SE40526	30W Driver with 12 Port JB4 Distributor	■	150x40x31mm	£36.12
SE40553	6W Driver with 4 Port JB4 Distributor	■	52x34x20mm	£17.16
SE40555	15W Driver with 6 Port JB4 Distributor	■	120x45x20mm	£20.88
SE40556	30W Driver with 12 Port JB4 Distributor	■	155x42x32mm	£34.20
SE40557	50W Driver with 12 Port JB4 Distributor	■	185x60x31mm	£53.88



12V & 24V driver examples



Unit 7 Speedwell Road
Whitwood, Castleford
West Yorkshire
WF10 5PY

tel: +44 (0)845 0340 780
fax: +44 (0)845 0340 781
email: info@sensio.co.uk
web: www.sensio.co.uk

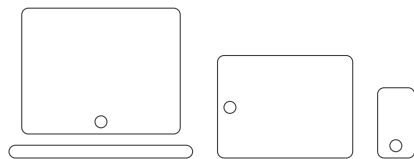

Desktop • Tablet • Mobile

www.sensio.co.uk

All prices are inclusive of 20% VAT and are Sensio's recommended retail prices. Prices are correct at the time of print (January 2016) and are subject to change after this date, without prior notification. All technical information is correct at the time of print however is subject to change throughout the course of the year.