



Unit 7 Speedwell Road,
Whitwood, Castleford,
West Yorkshire
WF10 5PY

tel: +44 (0)845 1639 047
fax: +44 (0)845 0340 781
email: info@sensio.co.uk
web: www.sensio.co.uk



The future of furniture lighting...



With a focus on British lighting design, high quality products and an unrivalled support structure, we want to show you the future of LED furniture lighting solutions.

We're always looking to the future and this year we strive to design and develop new and unique concepts for you and your customers. Designs to truly inspire you and bring your kitchen design to life, the way you want.

This year, to further emphasise the value we place on the high quality of our products, we have implemented a 5 year guarantee on all standard fittings. Alongside this we will further grow our support structure. Our representatives all originate from the furniture industry so we truly believe we have the skills and understanding to meet your requirements.

A handwritten signature in black ink that reads 'M. Linsky'.

Michael Linsky
Managing Director



Why Sensio?

Quality

We pride ourselves on offering superior quality products, using the best components and materials to guarantee long-life performance, high light output and enhanced durability. All of our products are certified by UK laboratories, are in line with our Quality Assurance Policy and come with a 5 Year Guarantee.

Innovation

Design and development has always been at the heart of what we do. We don't just follow the trends, we help set them. We design products in the UK, allowing us to put our expertise and industry knowledge to use to ensure every detail is designed with sheer excellence and to the highest standard.

Support

We offer comprehensive training, specialist marketing resources and an unrivalled support structure to offer guidance to all our customers. With over 13 years in the industry, we believe we have the knowledge and understanding to exceed your expectations.

Award winning product design:



INNOVATION AWARDS
EXCEL LONDON 2011



Contents...

Why Sensio...

- 4 About us
- 6 New for 2014
- 8 SLS LED technology
- 9 Which LED option?
- 10 Lithium-ion battery
- 12 The importance of kitchen lighting
- 14 Product design
- 15 Quality
- 16 Software
- 18 Point of sale
- 19 Approved Retailer Programme

Planning your lighting scheme...

- 20 Save energy - save money!
- 22 Which colour temperature?
- 24 Cable connect system
- 25 Connecting by colour
- 26-29 Developing a kitchen lighting scheme
- 30-31 Traditional kitchen solution
- 32-37 Modern kitchen solutions
- 38 Where to position lights in your kitchen

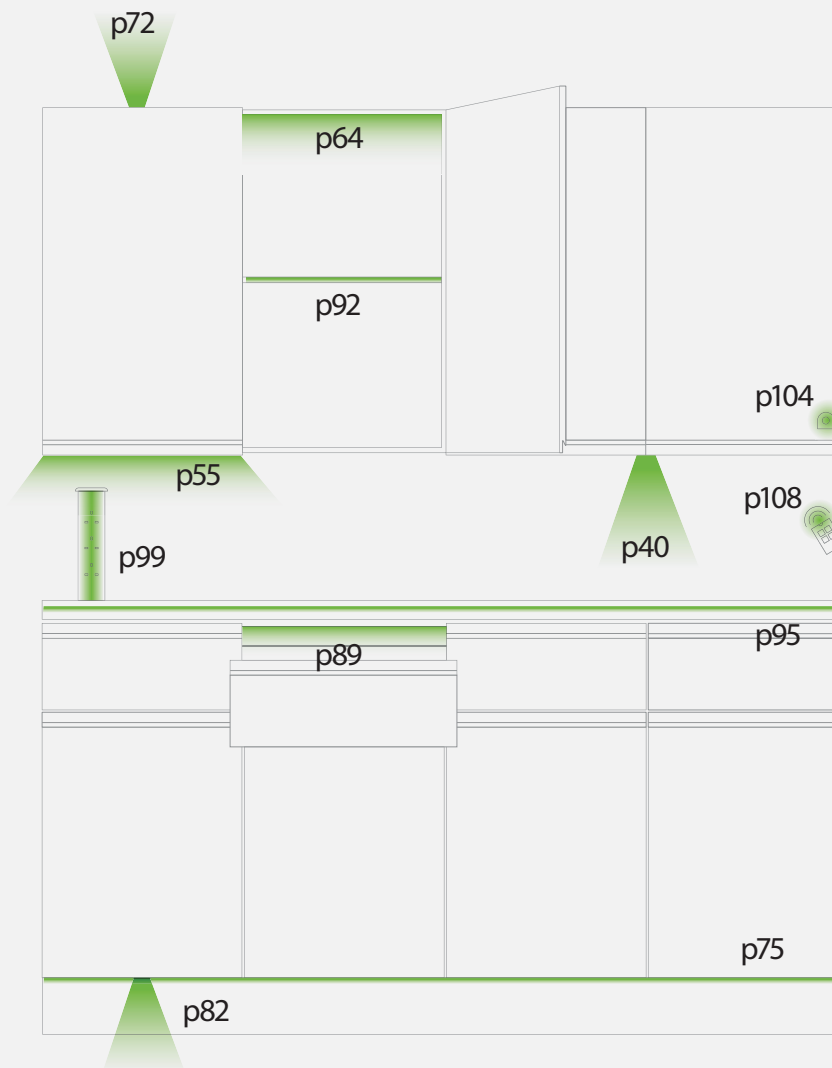

Sensio products for every kitchen...

- 40 Under Cabinet Spot Lighting
- 55 Under Cabinet Strip Lighting
- 64 In Cabinet Lighting
- 72 Over Cabinet Lighting
- 75 Flexible Strip Lighting
- 82 Plinth Lighting
- 89 Drawer Lighting
- 92 Shelf Lighting
- 95 Integrated Solutions
- 99 Sensiopod
- 104 Sensors & Controllers
- 108 Dimming Remote Controls
- 111 Drivers

About us...

Sensio was established in 2006 as a small, family run business, stemming from humble beginnings over 13 years ago. Still operating as a family business, Sensio's reputation for introducing high quality, pioneering lighting solutions continues to grow year on year.

In 2013 Sensio invested in new premises in Castleford, West Yorkshire. Moving from the previous 9,000 square foot premises to the current 29,000 square foot premises. The new premises has allowed restructuring of the business internally, allowing for a more efficient and professional operation. Sensio now has their own product design and development department, allowing for unique and inspiring lighting designs to come to life in-house.

A fast growing, global brand, Sensio is established and operates in the UK, America & Slovenia. We boast a high OTIF performance and a low returns rate of only 0.025%.



innovate.
create.
illuminate.™



NEW for 2014...

Look out for this symbol on the product pages to indicate new products for 2014.

NEW



Page 56

Connex SLS LED Under Cabinet Strip Light



Surface Light Source (SLS) products are the latest in LED technology. The fitting has a diffused cover meaning there are no visible LED points. The Connex is a direct alternative to the inefficient T5 Fluorescent strip lights. Available in warm white LED to compliment traditional kitchen styles.



Page 41

SLS Recessed/Surface Light



Also new to the SLS range is the sleek recessed/surface light. With its aluminium finish, high output and concealed LED's, this is the ultimate contemporary under cabinet spot light. Available in both cool white and warm white LED to suit all kitchen styles.



Page 76

DuoFlex Dual Colour LED Flexible Strip

The DuoFlex encompasses both cool and warm white LED's on the one flexible strip. Bringing true flexibility to flexible strip lighting, the DuoFlex allows you to seamlessly mix colour to create the perfect mood.





Incline Rechargeable LED Strip Light



Rechargeable, angled LED strip light containing a Lithium-ion battery. Recharge via USB outlet or socket. Integrated PIR sensor for on/off switching. 5 lengths available but can be cut to length if required. No electrical installation required – anyone can install.



Solus Rechargeable LED Angled Spot Light



Rechargeable, angled LED spot light containing a Lithium-ion battery. Recharge the product via a USB outlet or socket. Integrated PIR sensor for on/off switching. Cable free, no electrical installation required – anyone can install.

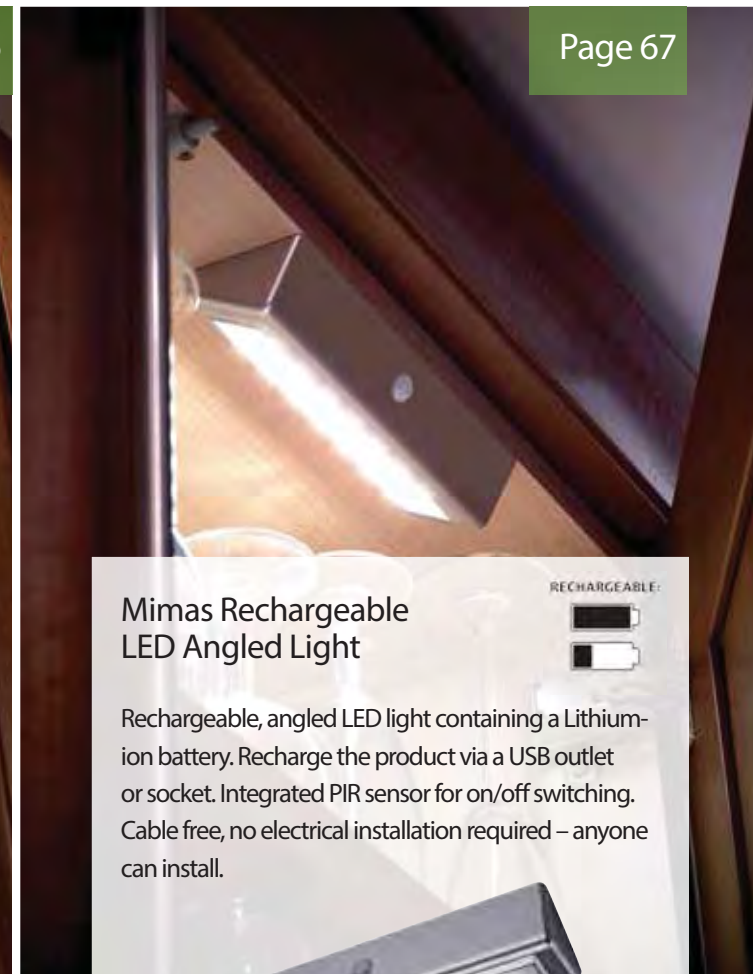

Mimas Rechargeable LED Angled Light



Rechargeable, angled LED light containing a Lithium-ion battery. Recharge the product via a USB outlet or socket. Integrated PIR sensor for on/off switching. Cable free, no electrical installation required – anyone can install.



A Bright **NEW** Idea from Sensio

The latest LED technology. Higher light output and no visible LED points.

SLS
surface light source

- No visible diodes. The LED's are concealed by an opaque cover to create a diffused effect without compromising on output.
- Latest technology. The SLS fittings have more LED's integrated to provide the high light output.
- Two styles available. The SLS Recess/Surface Light in cool or warm white LED and the Connex strip light in warm white LED.
- Sleek, contemporary updates. The SLS Recess/Surface Light & Connex can be specified as replacements for halogen and T5 fluorescent.

Why Sensio's SLS?

- Sleek designs
- Low energy consumption
- Highest lumen output
- Wide beam angles
- Simple to install
- Long life span

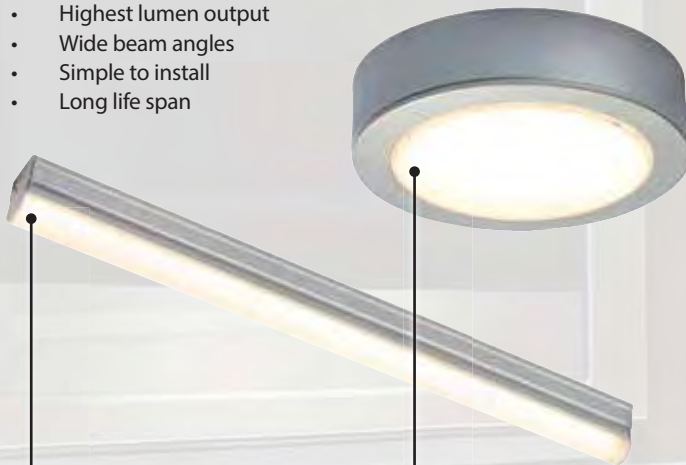





> Connex Strip Lights can be interlinked to form a continuous run of light.

> Recess/Surface Lights can be surface-mounted or recessed, and comes with a spacer for surface mounting.



Which LED option?

With constant advancements in LED technology it can be difficult to quickly determine which LED option is the best option for you. Use our quick reference table which compares the different features of the 4 types of LED available in our LED spot lighting category.

	SLS	HD	Genus	GX53
Wattage	3W	1.65W	1.4W	2.8W
Voltage	■ 24V	■ 24V	■ 12V	240V
Lumens	194-216Lm	80-85Lm	72Lm	245-250Lm
Kelvin	3000/5000K	3200/5000K	4000K	3000/5800K
Beam angle	105°	60°	100°	120°
LED Qty	30	24	21	50
Dimmable?	Yes	Yes	Yes	No
Lifespan	12.5 years	12.5 years	12.5 years	12.5 years
Finishes	Aluminium	Aluminium & stainless steel	Stainless steel	Stainless steel
Fitting styles	Surface/recess	Surface/recess & triangle	Surface/recess, triangle & rectangle	Surface/recess & triangle
Surface/recess option image				
Why this range?	No visible LED points, achieve the same look and light output as you would from halogen.	Various fitting styles and finishes available. A best selling range since its introduction in 2009.	First generation LED. The budget option with a RRP of £16.44 for a surface/recess light option.	Mains voltage, no driver required, simple to install & maintain. Highest light output with 50 LED's integrated.

Innovative Lithium-ion Battery

Rechargeable Lithium-ion battery fittings are new for 2014. There are 3 products in the in-cabinet section of this catalogue (pages 65-67). This page tells you all about the features of the rechargeable battery.

Advantages of our rechargeable battery lighting range

- No wiring. No electrical installation required. Anyone can fit.
- Simple to maintain. The battery within these fittings is to be recharged as required using a pluggable USB charger.
- Low running cost. The battery only needs to be recharged 2-3 times a year (based on an average usage figure).
- Flexibility. The fitting can be placed as required in the cabinet without worrying about holes for cable.

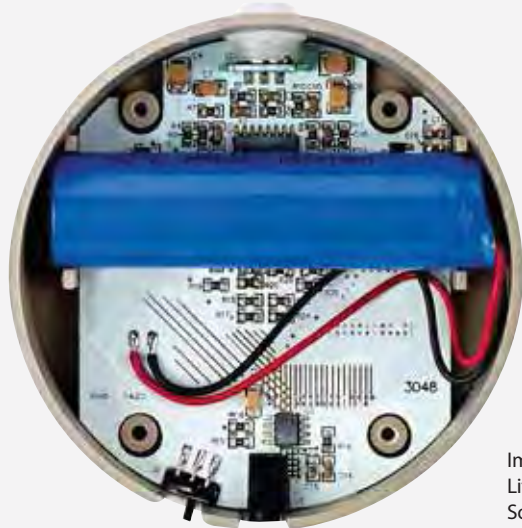

Image shows the rechargeable Lithium-ion battery inside the Solus LED fitting.



Image shows the Solus on charge using the USB outlet on the charger.

About the battery

- Lithium-ion battery
- Rechargeable
- High energy density
- Slow loss of charge when not in use
- Self-discharge rate of approximately 5-10% per month
- The lifespan of all products in the battery range is 30,000 hours
- Pluggable charger with 1m or 5m USB charging cable
- Charging time 5-6 hours on average
- The running time of battery operated products between charging is 8 months on average (based on 2.5 minutes usage per day)

LED Bedroom Lighting

Our 50 page LED Bedroom Lighting catalogue consists of bedroom lighting design idea's, a range of innovative Lithium-ion battery products & mains voltage products. Be inspired by the possibilities and stunning effects which can be created by using the unique and innovative products in this catalogue.



To request a copy of our LED Bedroom Lighting catalogue email your company name, address and a contact name to catalogues@sensio.co.uk and quote 'bedroom catalogue'.

The importance of kitchen lighting

If there's one space in the home where getting the lighting right is absolutely critical, it's the kitchen. Here's just one example of how Sensio LED lighting can make the ordinary look, well, simply extraordinary.



before **sensio** lighting

innovate.
create.
illuminate.™



after **sensio** lighting

Product Design in the UK

Our aim is to push the boundaries of our industry by designing and delivering the most innovative, unique products brought to you by our in-house team. We keep fully abreast of the latest consumer opinions and market trends; it's what fuels our ideas for new product development and prototypes.



We design products at our head office in West Yorkshire to ensure we have the highest degree of control and continually deliver new and innovative ideas to excite our customers.

Helping you bring your customers visions to life is our inspiration which is why we will continue to listen and grow our own unique product offering.

We don't just think lighting, we think furniture; to ensure our unique product offering enhances your designs.



sensio^o
furniture lighting solutions

Quality

At Sensio we never compromise on quality, we ensure that every one of our products meets the highest quality standards. When you recommend Sensio products to your customers, you are recommending innovation with long-term benefits.

innovate.
create.
illuminate.™



Sensio is a member of the Lighting Industry Association, whose mission is to strengthen the industry and promote the benefits of good quality lighting by representing all aspects of UK, EU and international legislation and standards. The Association works to protect the interests of both the consumer and its members, so we are the first to hear and react to updates, new legislation and any changes that affect the lighting industry.



To reflect the high quality of our product portfolio, every Sensio lighting product comes complete with a 5 year guarantee* for your customers' peace of mind.

*After 1 year, proof of purchase must be shown.



We pride ourselves on offering superior quality products, using the best components and materials to guarantee long-life performance, high light output and enhanced durability. All Sensio products have a Colour Rendering Index (CRI) of at least 80. All of our products are certified by UK laboratories.

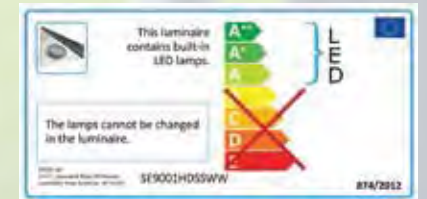

New regulation for 2014 - energy efficiency labelling. The energy labels indicate the energy rating of each luminaire. A++ indicates the most energy efficient products, and E, the least efficient. These labels will be included on the product packaging and on the product data sheet (www.sensio.co.uk).

Software

We know how important it is for you to show your customers just how their kitchen design will look with well-planned and positioned lighting. That's why we've made it as easy as possible for you by ensuring the Sensio product portfolio is available on the leading kitchen design software.

Why



Sensio product is available

sensio

LIGHTING
SPECIFICATION
MODULE

Image taken from 20-20
Technologies showing a
representation of different
lights from the Sensio range.

(N.B. both cool and warm white LED
are shown for visual purposes only).

... on all the leading kitchen design and online ordering software platforms...



www.2020technologies.com

A quick and simple system with which you can plan and specify a truly representative full lighting plan into any CAD kitchen design.

This means your customer can get a real feel for how their kitchen will look with the exact lighting they will receive included.

- > Select lighting by location as the products are laid out in the Sensio catalogue.
- > The lighting models are a true representation of the actual products – lumen values, beam angles, kelvins and dimensions have all been taken into consideration when the models were produced.
- > Create a quote for the lighting specified in 20-20 Technologies directly, alternatively link to KBB Connect to create your quote with no need to re-input the information.



www.kbbconnect.co.uk

You can easily quote and order Sensio items via this very simple system. The Sensio listing has been designed to save you time, with all the information you need in one place.

We've thoroughly thought out the information and layout of the information on KBB Connect and spent a lot of time in perfecting the system to make it as simple and effective to use as possible.

- > In-situ photographs of all products so your customers can fully appreciate how the fitting will look when in place.
- > Products are broken down by kitchen location, making it even easier to choose the required lighting options.
- > We've added a pop-up feature for all items which require a driver/cabling to run, so it's clear and simple to select the correct driver/cable before ordering.



www.eqsoftware.net

The Sensio listing on EQ Software contains all of the product technical information required to specify lighting for your customer. You can order the products you need easily and efficiently, getting it right first time.

- > Images of all products listed.
- > A good amount of product detail is available, meaning the customer will not need to refer back to the individual product pages of the catalogue for the details such as wattage, dimensions, cable length etc.
- > RRP's.
- > All products have a pop-up feature applied when they are being quoted, the driver, cabling (where required) and optional sensors are listed. This enables the user to select the required driver/cables and gives them the option to choose a control option for their lighting choice.



www.compusoftgroup.com

The Sensio catalogue is available to users of the Winner Design software (Compusoft GB Ltd). A quick and simple, yet effective piece of software which makes it simple to specify the required lighting for your designs.

- > Generic product models, however the full Sensio catalogue is available and the Sensio codes are added to your design in the area's specified.
- > The cost of the lighting is added to the customer quotation for all lighting specified. Following confirmation of the quotation you are able to send an email directly to your supplier of Sensio products, to save you time.
- > Calculate your profit margin via the Winner software.

Point of Sale

As part of our commitment to helping the retailer, we offer a select range of POS to help you to communicate our product offer and to help ensure your customer chooses the right lighting solution for their new kitchen. To discuss POS options please contact your Sensio representative or our office on 0845 0340 780.

The point of sale lighting board is the perfect solution to demonstrate different lighting options to your clients.

Product code: POSBOARD



The cost saving board allows you to demonstrate to customers the money they can save on their energy bills by opting for LED kitchen lighting rather than halogen.

The board contains; 1 x 20W halogen light, 1 x 1.65W HD LED light, appropriate driver/transformer and 2 x energy meters.

Product code: POS1



The Illumination Station has warm white and cool white LED fittings and 2 PIR sensors fitted. This tool allows you to demonstrate to customers the difference warm white and cool white LED's have on different worktops or doors, allowing them to select the best LED option to perfectly compliment and augment the materials chosen for their new kitchen design.

Product code: POS2

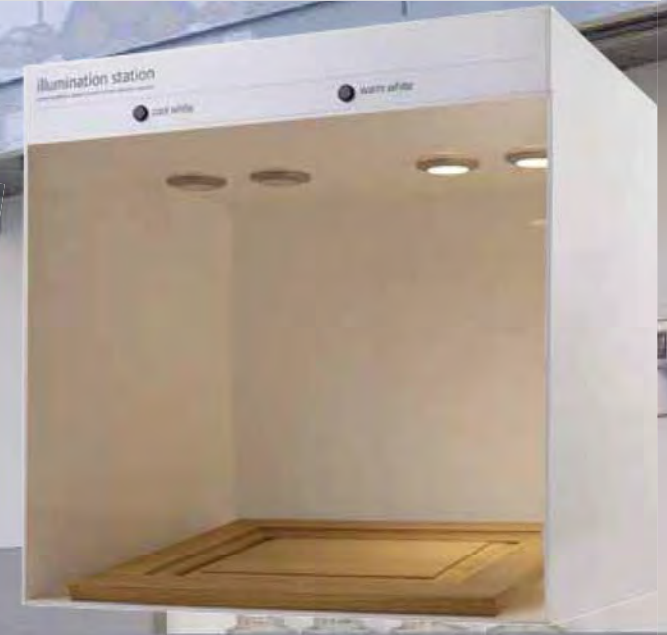

NB Photography is for illustrative purposes only - the configuration of the POS purchased may differ slightly from these images.

Approved Retailer Programme

The aim of the Approved Retailer Programme is to increase your sales of lighting and to supply you with the knowledge and tools so that you are better equipped to inform your customers of the range of lighting possibilities available, therefore helping reinforce your showroom's superiority over your competitors. Benefits include...

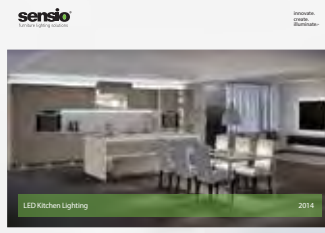

> FREE Showroom kitchen lighting planning
Let Sensio help you plan the perfect lighting schemes for your showroom displays.

> A Consumer friendly lighting catalogue helps you create the perfect lighting solution for your client.

> An exclusive window sticker identifies to the consumer that you are an Approved Retailer of Sensio lighting.

> FREE point of sale materials

> Why Sensio?

When you deal with Sensio you're dealing with quality. We have an award winning profile and we're proud to bring you unique LED lighting solutions. With a sales team originating from the furniture industry, we truly do understand your requirements.

> A FREE listing for your business in the consumer-friendly "Find a Retailer" section of www.sensio.co.uk. Only Approved Retailers are listed here. (From mid 2014).

> Access to a dedicated lighting consultant
FREE technical support for all your lighting queries and needs.

Sensio is unique in the fact that its sales team is formed of staff originating from the furniture industry. The experience that each of Sensio's sales team have allows them to recognise the importance of a comprehensive lighting scheme and the significant impact it can have on both the appearance and functionality of any kitchen design.

> Quarterly updates featuring new product developments, latest lighting trends and industry innovations to help keep you ahead of the competition.



Interested in becoming a Sensio Approved Retailer?
Contact us on 0845 0340 780 and quote 'ARP'. Alternatively, email arp@sensio.co.uk

LED Lighting

LED will soon be the only option when it comes to kitchen lighting. This is mainly due to the energy efficiency, long-term cost saving benefits and the array of possibilities. These pages detail the reasons why LED lighting is the smartest choice.

Save energy, save money

- > Although the initial cost of an LED fitting is higher, they last over 13 times longer than Halogen, saving you money on replacement lamps.
- > The savings you will make on electricity bills more than offsets this initial difference.
- > Thanks to the low power consumption of LED's you will see significant energy cost savings - meaning cheaper electricity
- > The testing station (shown on the right) was set up to measure the energy usage of an LED light v a Halogen light of equal brightness. The difference in energy used was staggering. One single LED light will save you £8.76 annually.

Annual
Cost Savings
£70.08*

- *Cost savings based on:
- > 8 hours usage per day
 - > One 20W halogen fitting costs £9.66 per year to run.
 - > One 1.65W HD LED fitting costs £0.90 per year to run. A saving of £8.76 per fitting per year.
 - > Therefore, based on a kitchen having 8 under cabinet lights installed, the saving on electricity bills per year would be £70.08.



innovate.
create.
illuminate.™



Dimmable

- > The majority of LED lighting in this catalogue can be dimmed via the Sensio range of LED dimmers
- > This gives the customer increased flexibility.



Long Lifespan

- > LED's have a lifespan of approximately 12.5 years, halogen only 1.5 years.
- > The lifespan of an LED fitting can ultimately outlive the kitchen itself.
- > No need to replace fittings or lamps - saving the customer time, hassle and money.



Advanced Technology

- > The advancement of LED technology is rapid
- > LED fittings without visible LED points are now available
- > The LED chip technology continues to advance to give brighter lighting.
- > The look and design of LED fittings continue to advance with ever increasing slimline products which maintain the high light output.



More Options

- > The majority of products are now available in cool white and warm white LED meaning the customer can create stunning lighting effects by choosing the LED colour which will maximise the impact of any kitchen design and colour scheme.
- > LED brings a whole new set of possibilities to kitchen design. For example the range of flexible strips - various levels of brightness, different LED colours - used in numerous locations in the kitchen to create stunning effects.



Eco Friendly

- > LED fittings have an incredibly low power consumption despite their high light output. A standard HD LED under cabinet lighting runs at only 1.65W.
- > LED lighting uses over 90% less energy than halogen lighting.

Colour Temperatures

The following pages demonstrate the impact well-planned and positioned LED lighting can make on any kitchen setting. But first it's important to understand the differences between 'warm white' lighting and 'cool white' lighting and how each interacts with different kitchen surfaces and colourways.



Traditional Style Kitchens

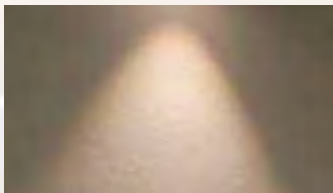

Warm White

2850K – 3250K



Contemporary Kitchens

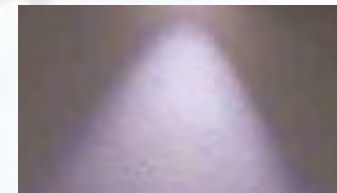

Cool White

5000K – 5650K



Marble



Sandstone

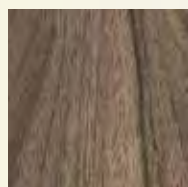

Woodgrains

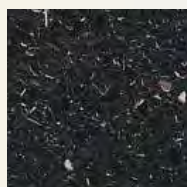

Black Granite, Gold Fleck

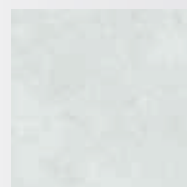

Grey Granite

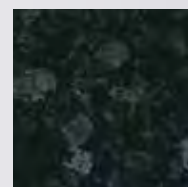

Slate

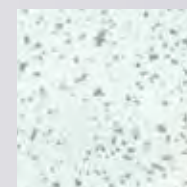

White Granite, Silver Fleck

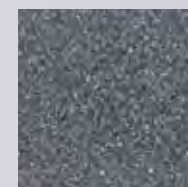

Granite, Silver Fleck



Dark Oak, Medium Oak or Walnut



Light Oak, Beech or Ash



Ivory or Cream



Painted Doors

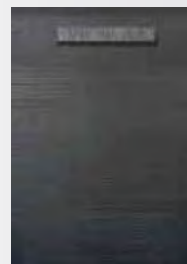

Dark Oak or Dark Ash



Bleached Oak

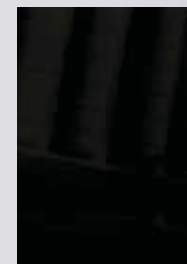

Gloss Black



Gloss White

With this brochure, we're aiming to make it as easy as possible for you to guide your customers towards the right LED lighting solution for their choice of kitchen, ensuring it's as stunning as it is functional. Match your worktop/door finish to one of the LED colours below:

Warm White

Produces a cosy, calming effect which complements a traditional style kitchen featuring wood surfaces and muted worktops perfectly.

Cool White

Gives a more modern effect, bouncing off gloss or contemporary surfaces to create a stunning effect.

Cable connect system

Changing LED light fittings couldn't be simpler!
The Sensio cable connect system enables light fittings to be easily changed without the need to access or remove existing cabling.

Features & benefits:

- > No need for a fitter if you wish to change or replace an LED fitting as the cabling does not need to be accessed or pulled through from behind the cabinet
- > Lamps can be changed by anyone



- > Available on HD LED under cabinet spot light products
- > Each fitting has a 2.5m cable. The lamp has a 35mm cable with JB4 plug which connects to the main run of cable



Connecting by colour

Sensio's colour coding system makes ordering everything required for your lighting design just that little bit simpler.

To simplify the process of selecting the appropriate driver for your lighting requirements, Sensio use a simple colour coding system. The cable on the light fitting, the distributor block on the driver and the outer packaging for each product all carry a colour-coded label.

- > All components are colour coded.
- > The packaging is colour coded.
- > The cable on the product (above the connection plug) is colour coded, this ensures that all products are connected to a driver for the required voltage.
- > The wattage of the driver is also indicated on the block so when connecting fittings you can be sure not to exceed the wattage allowance of the driver.

All components and even the packaging is colour coded.



All drivers featured in this brochure are coded with a small coloured square. Simply refer to the product table opposite to find the colour that is correct for your lights.



Developing a kitchen lighting scheme >

Mood Lighting

The key to achieving a lighting scheme that meets your customers' aesthetic aims as well as their practical needs is in understanding how they will use the space as both a working area and a design feature of the home.



Mood Lighting

Mood lighting is used to add dimension and depth to the room in order to create atmosphere and ambience. Mood lighting is generally soft and unobtrusive, used for decorative rather than functional purpose. Often the most overlooked aspect of kitchen lighting, Mood Lighting really does have the biggest impact!

innovate.
create.
illuminate.™



Developing a kitchen lighting scheme >

Task Lighting

Understanding the lighting needs of the kitchen as a working space is crucial when planning a lighting scheme. Ask your customers how they envisage using the space and where and when they will need specific light sources.



Task Lighting

Task lighting does exactly what the name suggests. It is perfectly positioned to ensure the kitchen is an efficient working space for everyday tasks like food preparation. Typically, task lighting is positioned under wall units to illuminate the worktop, giving light exactly where it is needed.

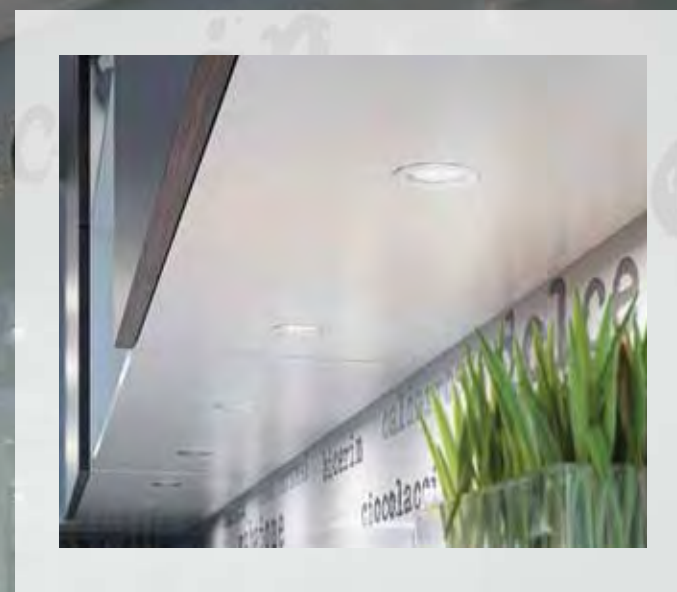

Developing a kitchen lighting scheme >

Convenience Lighting

innovate.
create.
illuminate.™

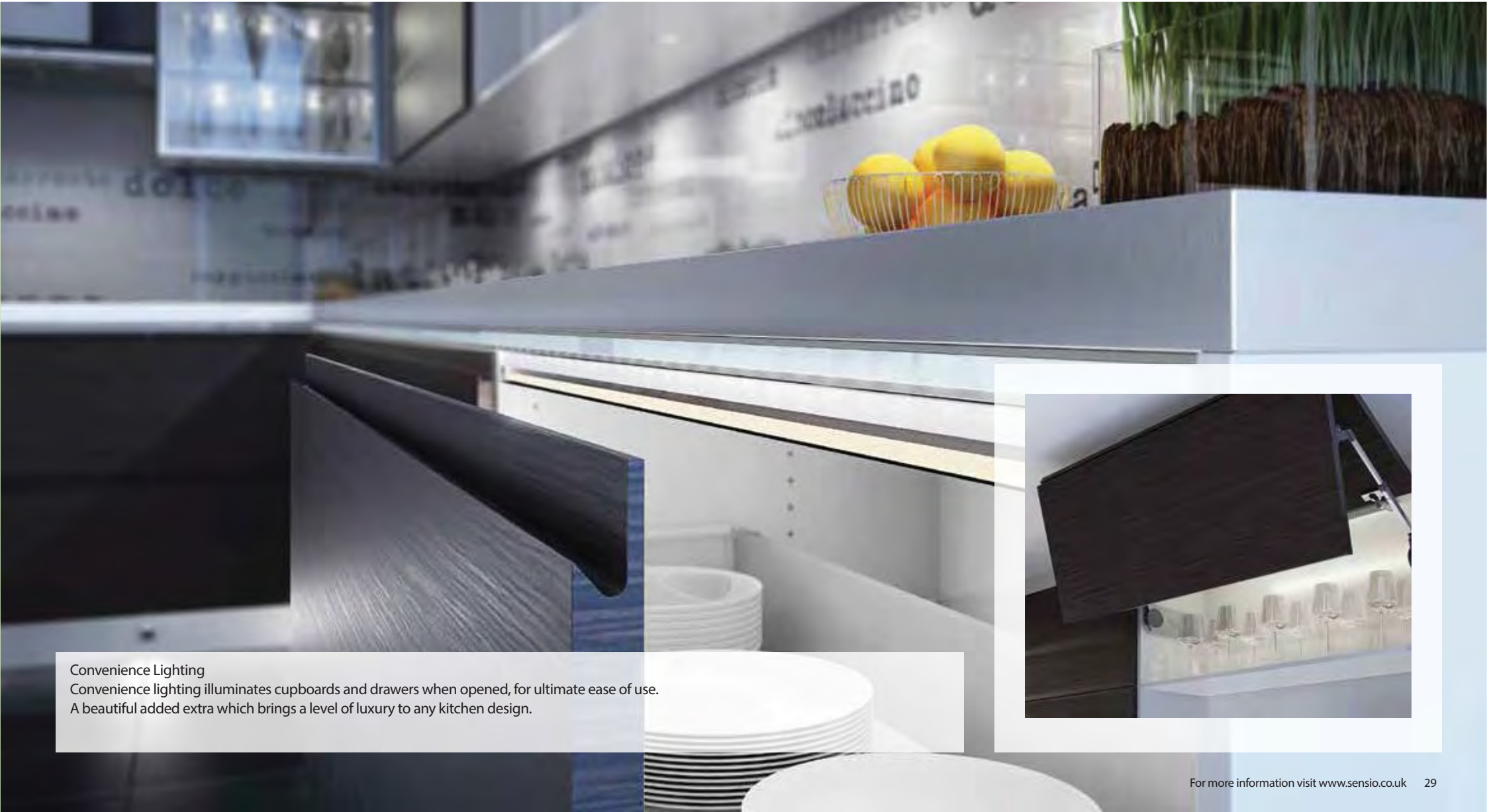

Convenience Lighting

Convenience lighting illuminates cupboards and drawers when opened, for ultimate ease of use. A beautiful added extra which brings a level of luxury to any kitchen design.

Lighting a traditional style kitchen, solution 1

A traditional kitchen setting is shown to its best advantage by using 'warm white' LED lighting.

Here we've taken a wood worktop and cream cabinets and added the finishing touches with warm white task lighting beneath the cabinets and atmospheric warm white mood lighting beneath the mantel and as illumination for the glass-front cabinets and cupboard plinths. The overall effect is calm, serene and inviting.



Light Indicator

Featured products



1
SE10166W0
5 x SLS RECESS/SURFACE
UNDER CABINET LIGHT
See page 41



2
SE10166W0
2 x SLS RECESS/SURFACE
UNDER CABINET LIGHT
See page 41



3
SE10193W0
3 x CONNEX LED STRIP
LIGHT
See page 56



4
SE40682
1 x 2 CHANNEL DIMMING
REMOTE CONTROL
(SE40675 also required)
See page 109



5
SE10311WW
4 x VIVA LED FLEXIBLE
STRIP LIGHT
See page 78



6
SE80050SS
1 x SENSIPOD+
(Stainless Steel)
See page 101



7
SE7305HDCW
2 x VERSO LED DRAWER LIGHT
See page 90

Note: Products shown are not to same scale



Lighting a modern style kitchen, solution 1

A contemporary kitchen such as this is often best complemented by using 'cool white' LED lighting.

This colour temperature bounces off the sleek high gloss surfaces to incredible effect. Strip lighting is perfect for the clean, minimal, modern lines of the design. No fuss, simply stunning.

Light Indicator

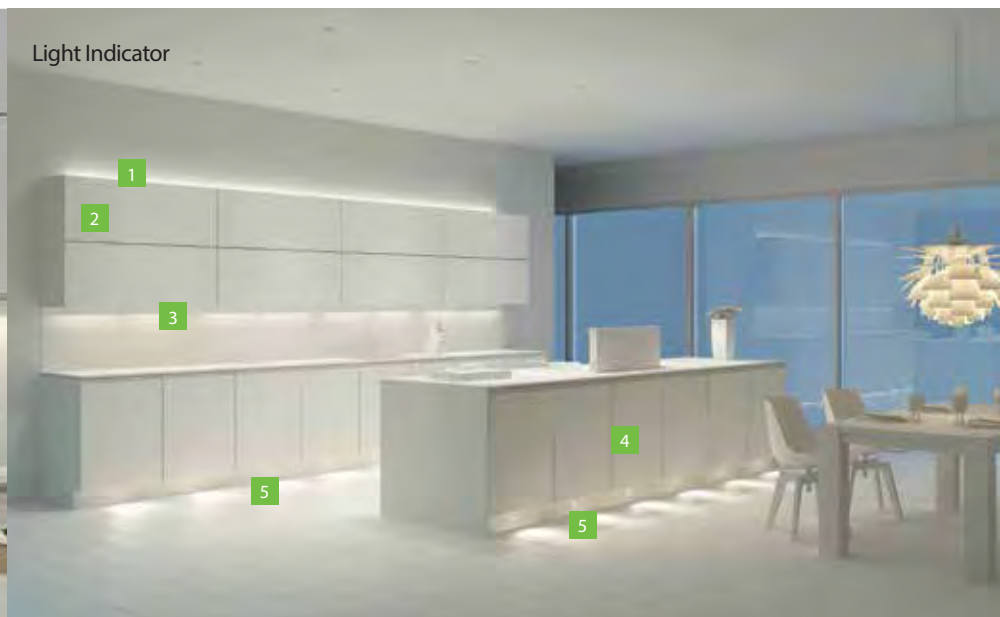

Featured products



1
SE10021DO
2 x DUOFLEX FLEXIBLE STRIP
See page 76



2
SE7210HDCW
4 x CONA LED IN CABINET
LIGHT WITH PIR
See page 68



3
SE7110HDCW
4 x TRIPLO DIMMING UNDER
CABINET STRIP LIGHT
See page 61



4
SE7325HDCW
1 x VERSO LED DRAWER LIGHT
See page 90



5
SE10139CW
2 x SPECTO LED PLINTH LIGHT KIT
See page 87

Note: Products shown are not to same scale



Lighting a modern style kitchen, solution 2

For the ultimate modern kitchen design, opt for the most innovative coolwhiteHDLEDlightingsolution.

Floating base units and frosted glass cabinets demand the very latest RGB flexible strip lighting with 7 pre-set colours. Continuous HD LED strip task lighting and the incredibleSensioPod+set into the island unit make this kitchen as practical as it is a contemporary design statement.

Light Indicator



Featured products



1

SE10322
6 x LED RGB COLOUR
CHANGING FLEXIBLE STRIP
See page 80



2

SE10166C0
8 x SLS RECESSED/SURFACE
UNDER CABINET LIGHT
See page 41



3

SE40520
1 x 250W DIMMING
SENSOR SWITCH
See page 105



4

SE9072HDCW
6 x LINCA LED STRIP
LIGHT
See page 58



5

SE7325HDCW
3 x VERSO LED DRAWER LIGHT
See page 90



6

SE80050SS
1 x SENSIOPOD+
(Stainless Steel)
See page 101

Note: Products shown are not to same scale



Lighting a modern style kitchen, solution 3

For compact, contemporary kitchen layouts, opt for cool white LED lighting to create a feeling of space.

This sleek and simple kitchen design is brought to life with internal HD LED recessed/surface lights to provide mood lighting within frosted cabinets; the HD LED flexible strip to uplight the floating base; and continuous cool white LED strip lighting beneath the cabinets for optimum task lighting. A simple lighting scheme that delivers an incredible visual punch.

Light Indicator



Featured products



1
SE90312HDCW
3 x VEGA HD LED FLEXIBLE
STRIP LIGHT
See page 79



2
SE9005HDSSCW
6 x HYPE HD LED RECESSED/
SURFACE LIGHT
See page 44



3
SE12550
6 x ALBUS LED STRIP LIGHT
See page 63



4
SE7320HDCW
3 x VERSO LED DRAWER LIGHT
See page 90



5
SE80050AL
1 x SENSIPOD
(Aluminium)
See page 100

Note: Products shown are not to same scale



Where To Position Lights in Your Kitchen

Mood Lighting

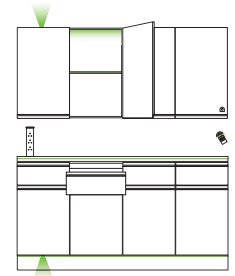

1 Over Cabinet Lighting

See page 72

2 Flexible Strip Lighting

See page 75

3 Plinth Lighting

See page 82

4 Shelf Lighting

See page 92

5 Integrated Solutions

See page 95

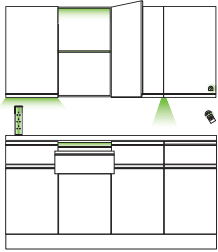

Task & Convenience Lighting

Under Cabinet
Spot Lighting

6

See page 40

Under Cabinet
Strip Lighting

7

See page 55

In Cabinet
Lighting

8

See page 64

Drawer
Lighting

9

See page 89

Integrated
Solutions

10

See page 95

Sensiopod

11

See page 99



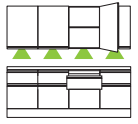

Under Cabinet Spot Lighting >



SLS Surface/Recessed Light

NEW

FINISH:
aluminium

LED COLOUR:
cool warm

LAMP LIFE:
11 years

RECOMMENDED LOCATION:

QUANTITY OF LIGHTS:
2 per m

DIMMABLE:

BEAM ANGLE:
105°

'invisible LED's, the future of LED technology'

- > Surface Light Source (SLS) products are LED fittings with no visible LED points.
- > Achieve the same look and light output as a halogen light whilst seeing significant savings on energy bills.
- > This sleek and elegant design looks great in both contemporary and more traditional kitchens.
- > Available in both cool white and warm white LED, choose the option which will work best with the work surface and kitchen style.
- > Use as task lighting under cabinets or to illuminate cabinet interiors in glass fronted wall units.
- > Spacer included, fitting can be surface mounted or recessed.
- > Long lamp life - lasts up to 11 years more than halogen.
- > Can be used with the range of Sensio switches and dimmers.
- > The SLS are only currently available in Aluminium as the metal is a good conductor of heat, allowing us to achieve the highest light output.

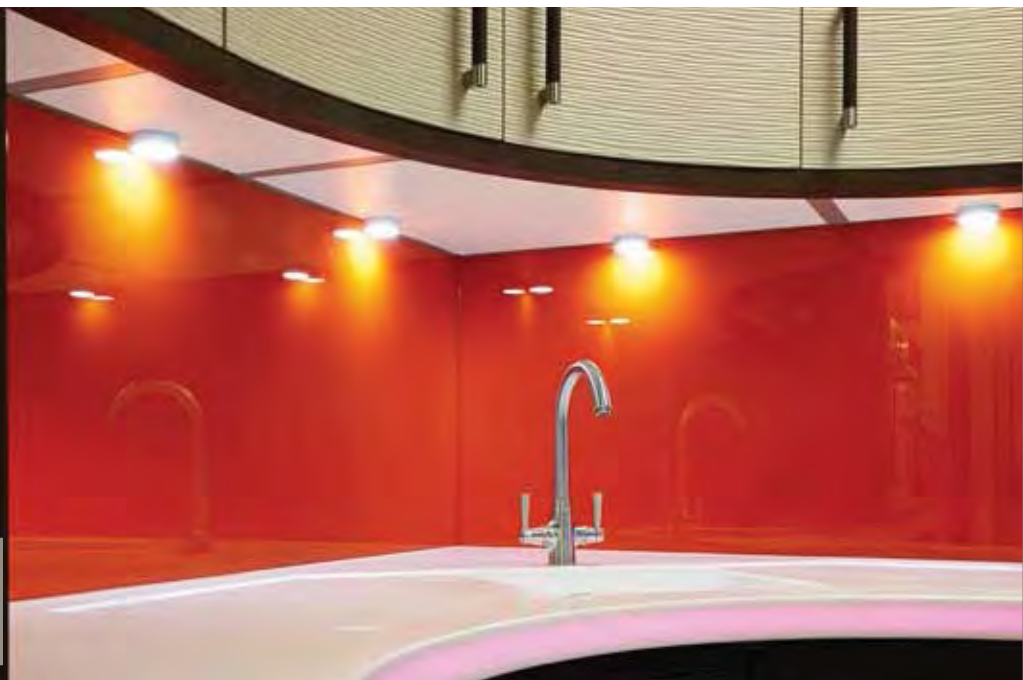

Code	Wattage	LED Colour	Qty	Lumens	Cable	Driver	RRP
SE10166C0	3W	Cool White (5000K)	1	216Lm	1.5m	■	£23.88
SE10166C2	6W	Cool White (5000K)	2	216Lm	1.5m	included	£64.68
SE10166C3	9W	Cool White (5000K)	3	216Lm	1.5m	included	£92.28
SE10166W0	3W	Warm White (3000K)	1	194Lm	1.5m	■	£23.88
SE10166W2	6W	Warm White (3000K)	2	194Lm	1.5m	included	£64.68
SE10166W3	9W	Warm White (3000K)	3	194Lm	1.5m	included	£92.28

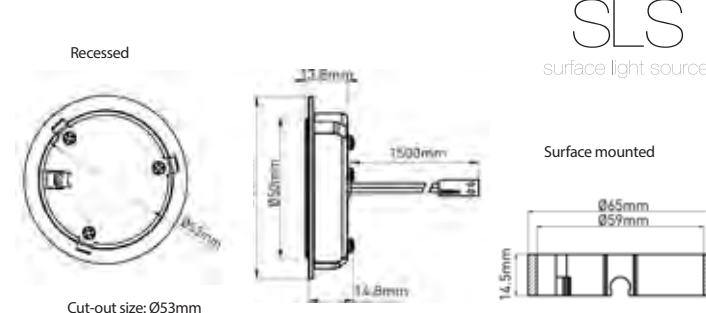

Accessories

- 2.5m extension cable (SE9009) - £2.04
- PIR in cabinet on/off sensor (SE2015000) Page 107
- Under cabinet IR swipe on/off sensor (SE40516) Page 108
- IR swipe on/off sensor switch (SE40517) Page 106

- In cabinet on/off switch (SE40518) Page 107
- IR on/off sensor switch & dimmer (SE40520) Page 105
- LED Dimming Remote Control (SE40580) Page 108
- Dimming remote control & receiver (SE40675 & SE40682/4) Page 109

Under Cabinet Spot Lighting >

Novus HD LED Triangle Light

FINISH:

aluminium

LED COLOUR:
 
cool warm

LAMP LIFE:

years

RECOMMENDED LOCATION:

QUANTITY OF LIGHTS:

2 per m

CABLE LENGTH:

2.5 metres





DIMMABLE:

BEAM ANGLE:

60°

'slim exterior, high brightness'

- > Slim profile design. Perfect where invisible lighting is required. High definition LED - each diode has a lens over it to intensify the light output.
- > Available in both cool white and warm white LED to suit a variety of kitchen designs.
- > Over 90% less energy used when comparing to halogen. Save money on electricity bills when switching from halogen to HD LED (see page 20 for savings calculation).
- > The sensor version has an integrated IR sensor, swipe your hand past the sensor to illuminate the fitting and connected lights.
- > Two non-sensor fittings can be connected to the sensor version via ports on the back of the fitting.
- > Sensor illuminates red to ensure visibility if the kitchen is dark.
- > By using an IR swipe sensor as task lighting in the kitchen, hygiene levels are maintained when preparing food etc.



Code	Wattage	LED Colour	Qty	Lumens	Driver	RRP
SE9001HDCW	1.65W	Cool White (5000K)	1	85Lm		£24.60
SE9001HDCWK2	3.3W	Cool White (5000K)	2	85Lm	included	£70.08
SE9001HDCWK3	4.95W	Cool White (5000K)	3	85Lm	included	£94.92
SE9001HDWW	1.65W	Warm White (3200K)	1	80Lm		£24.60
SE9001HDWWK2	3.3W	Warm White (3200K)	2	80Lm	included	£70.08
SE9001HDWWK3	4.95W	Warm White (3200K)	3	80Lm	included	£94.92
SE9001HDSCW	1.65W	Cool White (5000K)	1	85Lm		£35.40
SE9001HDSCWK2	3.3W	Cool White (5000K)	2	85Lm	included	£80.88
SE9001HDSCWK3	4.95W	Cool White (5000K)	3	85Lm	included	£105.60
SE9001HDSWW	1.65W	Warm White (3200K)	1	80Lm		£35.40
SE9001HDSWWK2	3.3W	Warm White (3200K)	2	80Lm	included	£80.88
SE9001HDSWWK3	4.95W	Warm White (3200K)	3	80Lm	included	£105.60

Non-sensor



Sensor

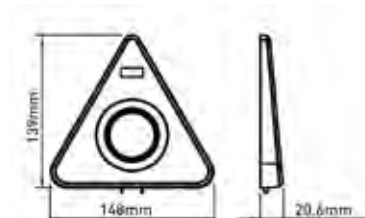

Complete with the Sensio cable connect system

Accessories - Non-sensor

- 2.5m extension cable (SE9009) - £2.04
- Under cabinet IR swipe on/off sensor (SE40516) Page 105
- IR swipe on/off sensor switch (SE40517) Page 106
- IR on/off sensor switch & dimmer (SE40520) Page 105
- LED Dimming Remote Control (SE40580) Page 108
- Dimming remote control & receiver (SE40675 & SE40682/4) Page 109

Accessories - sensor

- 2.5m extension cable (SE9009) - £2.04

Under Cabinet Spot Lighting >

Bermuda HD LED Triangle Light

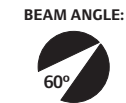
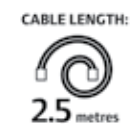
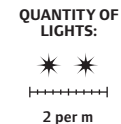
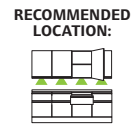
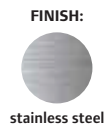

'traditional look, modern solution'

- > Stainless Steel fitting available with either cool white or warm white LED - great for both contemporary and traditional kitchens.
- > High Definition LED, each diode has a lens over it to intensify the light output.
- > The style of the fitting makes it a direct replacement for a halogen under cabinet triangle light. Purchase in warm white LED for a very similar colour representation also.
- > Long lamp life - lasts up to 11 years more than halogen.
- > Over 90% less energy used when comparing to halogen. Save money on electricity bills when switching from halogen to HD LED (see page 20 for savings calculation).
- > Control using the Remote Control Dimmer (page 108).



Code	Wattage	LED Colour	Qty	Lumens	Driver	RRP
SE9001HDSSCW	1.65W	Cool White (5000K)	1	85Lm	■	£18.12
SE9001HDSSCWK2	3.3W	Cool White (5000K)	2	85Lm	included	£56.64
SE9001HDSSCWK3	4.95W	Cool White (5000K)	3	85Lm	included	£74.88
SE9001HDSSWW	1.65W	Warm White (3200K)	1	80Lm	■	£18.12
SE9001HDSSWWK2	3.3W	Warm White (3200K)	2	80Lm	included	£56.64
SE9001HDSSWWK3	4.95W	Warm White (3200K)	3	80Lm	included	£74.88

Surface Mounted

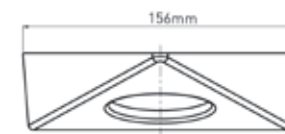
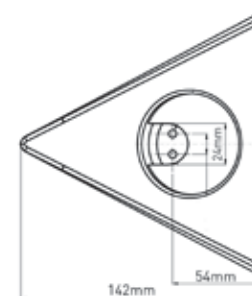

Complete with the Sensio cable connect system

Accessories

- 2.5m extension cable (SE9009) - £2.04
- Under cabinet IR swipe on/off sensor (SE40516) Page 105
- IR swipe on/off sensor switch (SE40517) Page 106
- IR on/off sensor switch & dimmer (SE40520) Page 105
- LED Dimming Remote Control (SE40580) Page 108
- Dimming remote control & receiver (SE40675 & SE40682/4) Page 109

Under Cabinet Spot Lighting >

Hype HD LED Surface Light

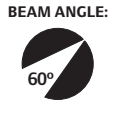
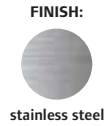

'task or mood lighting, you choose.'

- > The fitting is supplied with the collar, can be either surface or recess mounted.
- > Stainless Steel fitting available with either cool white or warm white LED - great for both contemporary and traditional kitchens.
- > High definition LED - each diode has a lens over it to intensify the light output.
- > Use as task lighting under cabinets or to illuminate cabinet interiors in glass fronted wall units.
- > Over 90% less energy used when comparing to halogen. Save money on electricity bills when switching from halogen to HD LED (see page 20 - for savings calculation).
- > Long lamp life - lasts up to 11 years more than halogen.
- > Can be used with the range of Sensio switches and dimmers.



Code	Wattage	LED Colour	Qty	Lumens	Driver	RRP
SE9005HDSSCW	1.65W	Cool White (5000K)	1	85Lm	■	£15.60
SE9005HDSSCWK2	3.3W	Cool White (5000K)	2	85Lm	included	£49.20
SE9005HDSSCWK3	4.95W	Cool White (5000K)	3	85Lm	included	£64.92
SE9005HDSSWW	1.65W	Warm White (3200K)	1	80Lm	■	£15.60
SE9005HDSSWWK2	3.3W	Warm White (3200K)	2	80Lm	included	£49.20
SE9005HDSSWWK3	4.95W	Warm White (3200K)	3	80Lm	included	£64.92

Surface Mounted



Inset



Complete with the Sensio cable connect system

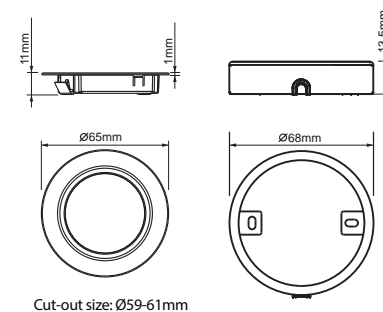

Accessories

2.5m extension cable (SE9009) - £2.04
PIR in cabinet on/off sensor (SE2015000) Page 107
Under cabinet IR swipe on/off sensor (SE40516) Page 105
IR swipe on/off sensor switch (SE40517) Page 106

In cabinet on/off switch (SE40518) Page 107
IR on/off sensor switch & dimmer (SE40520) Page 105
LED Dimming Remote Control (SE40580) Page 108
Dimming remote control & receiver (SE40675 & SE40682/4) Page 109

Under Cabinet Spot Lighting >

Argo HD LED Surface Light

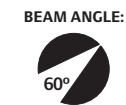
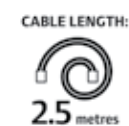
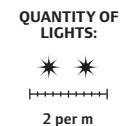
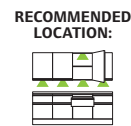

'A simple solution to create a stunning look'

- > The fitting is supplied with the collar, can be either surface or recess mounted
- > Die cast metal exterior with an aluminium effect finish.
- > High definition LED – each diode has a lens over it to intensify the light output.
- > Available in both cool white and warm white LED to suit a variety of kitchen designs.
- > Use as task lighting under cabinets or to illuminate cabinet interiors in glass fronted wall units.
- > Over 90% less energy used when comparing to halogen. Save money on electricity bills when switching from halogen to HD LED (see page 20 for savings calculation).
- > Long lamp life - lasts up to 11 years more than halogen.
- > Can be used with the range of Sensio switches and dimmers.



Code	Wattage	LED Colour	Qty	Lumens	Driver	RRP
SE9005HDCW	1.65W	Cool White (5000K)	1	85Lm	■	£21.00
SE9005HDCWK2	3.3W	Cool White (5000K)	2	85Lm	included	£60.72
SE9005HDCWK3	4.95W	Cool White (5000K)	3	85Lm	included	£81.84
SE9005HDWW	1.65W	Warm White (3200K)	1	80Lm	■	£21.00
SE9005HDWWK2	3.3W	Warm White (3200K)	2	80Lm	included	£60.72
SE9005HDWWK3	4.95W	Warm White (3200K)	3	80Lm	included	£81.84

Surface Mounted



Inset



Complete with the Sensio cable connect system

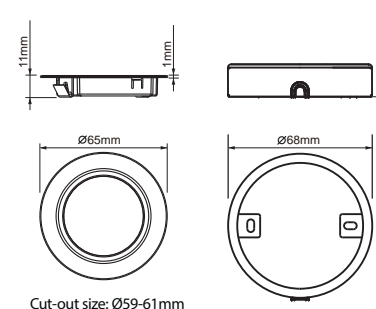

Accessories

2.5m extension cable (SE9009) - £2.04
PIR in cabinet on/off sensor (SE2015000) Page 107
Under cabinet IR swipe on/off sensor (SE40516) Page 105
IR swipe on/off sensor switch (SE40517) Page 106

In cabinet on/off switch (SE40518) Page 107
IR on/off sensor switch & dimmer (SE40520) Page 105
LED Dimming Remote Control (SE40580) Page 108
Dimming remote control & receiver (SE40675 & SE40682/4) Page 109

Under Cabinet Spot Lighting >

Fusion HD LED Surface Light

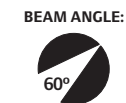
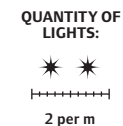
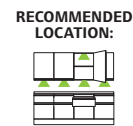

'create invisible lighting in dark cabinetry.'

- > The fitting is supplied with the collar, can be either surface or recess mounted.
- > Die cast metal exterior with a matte black finish.
- > High definition LED – each diode has a lens over it to intensify the light output.
- > Use as task lighting under cabinets or to illuminate cabinet interiors in glass fronted wall units.
- > Available in both cool white and warm white LED to suit a variety of kitchen designs.
- > Over 90% less energy used when comparing to halogen. Save money on electricity bills when switching from halogen to HD LED (see page 20 – for savings calculation).
- > Long lamp life - lasts up to 11 years more than halogen.
- > Can be used with the range of Sensio switches and dimmers.

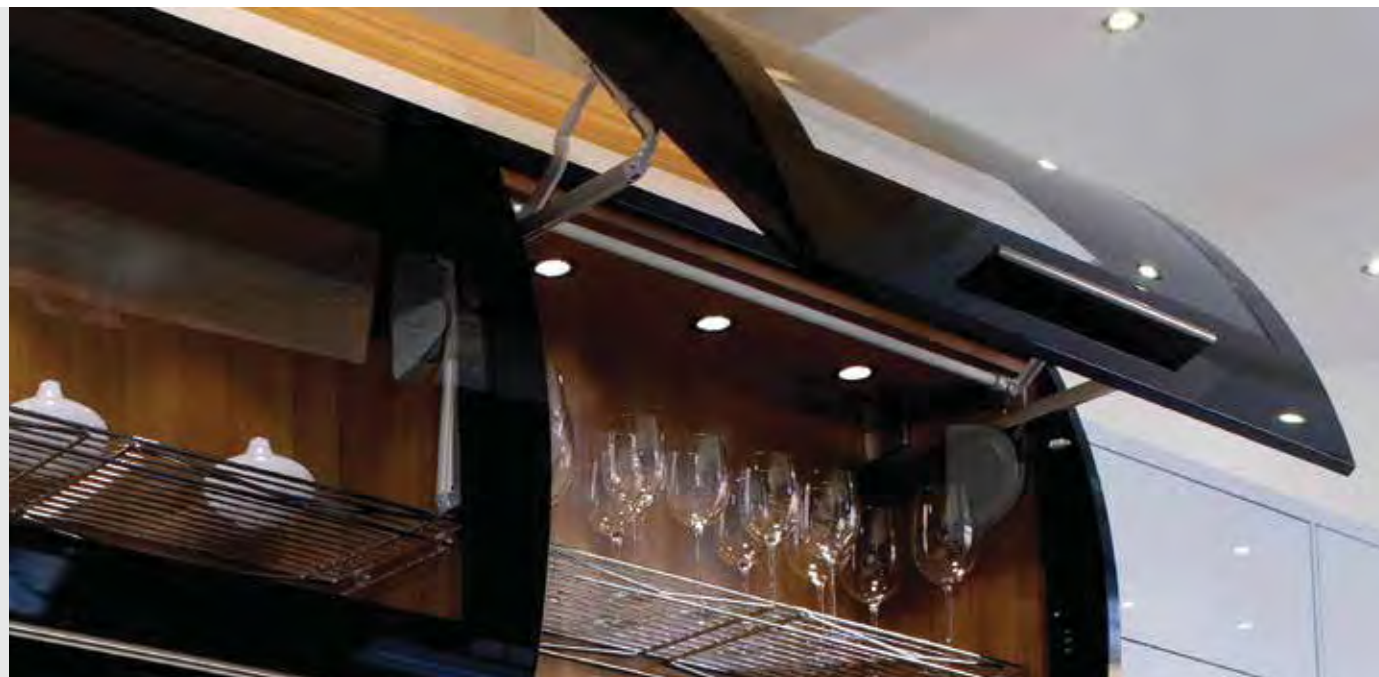

Code	Wattage	LED Colour	Qty	Lumens	Driver	RRP
SE9005HDBKCW	1.65W	Cool White (5000K)	1	85Lm	■	£15.84
SE9005HDBKCWK2	3.3W	Cool White (5000K)	2	85Lm	included	£65.76
SE9005HDBKCWK3	4.95W	Cool White (5000K)	3	85Lm	included	£85.08
SE9005HDBKWW	1.65W	Warm White (3200K)	1	80Lm	■	£15.84
SE9005HDBKWWK2	3.3W	Warm White (3200K)	2	80Lm	included	£63.60
SE9005HDBKWWK3	4.95W	Warm White (3200K)	3	80Lm	included	£85.08

Surface Mounted



Inset



Complete with the Sensio cable connect system

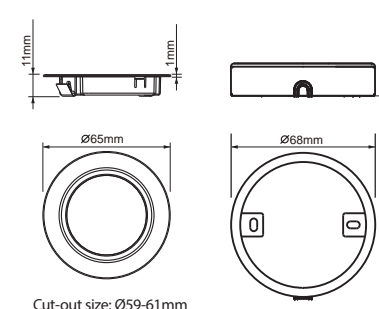

Cut-out size: Ø59-61mm

Accessories

2.5m extension cable (SE9009) - £2.04
PIR in cabinet on/off sensor (SE2015000) Page 107
Under cabinet IR swipe on/off sensor (SE40516) Page 105
IR swipe on/off sensor switch (SE40517) Page 106

In cabinet on/off switch (SE40518) Page 107
IR on/off sensor switch & dimmer (SE40520) Page 105
LED Dimming Remote Control (SE40580) Page 108
Dimming remote control & receiver (SE40675 & SE40682/4) Page 109

Under Cabinet Spot Lighting >

Ora Square Surface Light

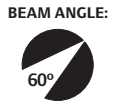
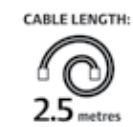
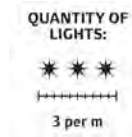
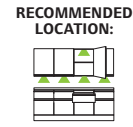

'perfect for the minimalist kitchen design'

- > Stainless Steel fitting available with either cool white or warm white LED - great for both contemporary and traditional kitchens.
- > This fitting has a depth of only 8.8mm, making it perfect where invisible lighting is required.
- > With a wattage of only 1.25W per fitting this product has an extremely low power consumption.
- > Use as task lighting under cabinets or to illuminate cabinet interiors in glass fronted wall units.
- > 18 High Definition LED's integrated, each diode has a lens over it to intensify the light output.
- > Long lamp life - lasts up to 11 years more than halogen.
- > Can be used with the range of Sensio switches and dimmers for on/off switching.



Code	Wattage	LED Colour	Qty	Lumens	Driver	RRP
SE9007HDCW	1.25W	Cool White (5000K)	1	63Lm	■	£18.36
SE9007HDCWK2	2.5W	Cool White (5000K)	2	63Lm	included	£54.84
SE9007HDCWK3	3.75W	Cool White (5000K)	3	63Lm	included	£73.20
SE9007HDWW	1.25W	Warm White (3200K)	1	60Lm	■	£18.36
SE9007HDWWK2	2.5W	Warm White (3200K)	2	60Lm	included	£54.84
SE9007HDWWK3	3.75W	Warm White (3200K)	3	60Lm	included	£73.20

Surface Mounted

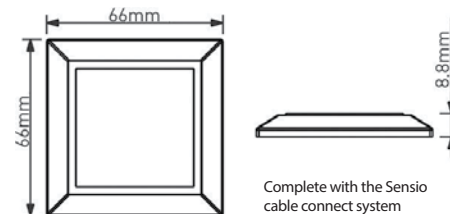

Accessories

2.5m extension cable (SE9009) - £2.04
PIR in cabinet on/off sensor (SE2015000) Page 107
Under cabinet IR swipe on/off sensor (SE40516) Page 105
IR swipe on/off sensor switch (SE40517) Page 106

In cabinet on/off switch (SE40518) Page 107
IR on/off sensor switch & dimmer (SE40520) Page 105
LED Dimming Remote Control (SE40580) Page 108
Dimming remote control & receiver (SE40675 & SE40682/4) Page 109

Under Cabinet Spot Lighting >

Focus HD LED Flat Disc Light

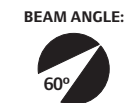
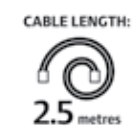
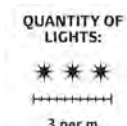
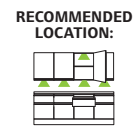

'ultra slim fitting'

- > Cool white LED and aluminium finish, perfect for contemporary kitchen designs.
- > This fitting has a depth of only 8mm, making it perfect where invisible lighting is required.
- > With a wattage of only 1.25W per fitting this product has an extremely low power consumption.
- > Use as task lighting under cabinets or to illuminate cabinet interiors in glass fronted wall units.
- > High Definition LED, each diode has a lens over it to intensify the light output.
- > Long lamp life - lasts up to 11 years more than halogen.
- > Can be used with the range of Sensio switches and dimmers for on/off switching.



Code	Wattage	LED Colour	Qty	Lumens	Driver	RRP
SE9010HDCW	1.25W	Cool White (5000K)	1	63Lm	■	£16.32
SE9010HDCWK2	2.5W	Cool White (5000K)	2	63Lm	included	£51.12
SE9010HDCWK3	3.75W	Cool White (5000K)	3	63Lm	included	£67.56

Surface Mounted

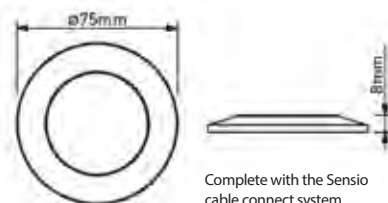

Complete with the Sensio cable connect system

Accessories

2.5m extension cable (SE9009) - £2.04
PIR in cabinet on/off sensor (SE2015000) Page 107
Under cabinet IR swipe on/off sensor (SE40516) Page 105
IR swipe on/off sensor switch (SE40517) Page 106

In cabinet on/off switch (SE40518) Page 107
IR on/off sensor switch & dimmer (SE40520) Page 105
LED Dimming Remote Control (SE40580) Page 108
Dimming remote control & receiver (SE40675 & SE40682/4) Page 109

Under Cabinet Spot Lighting >

Quadra PLUS - U LED Under Cabinet Light

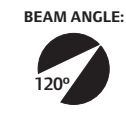
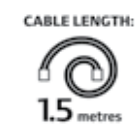
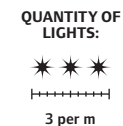
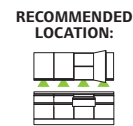

'lighting designed to be seen'

- > The lens on this fitting has a triphosphor coating, creating an even spread of light.
- > Available in both cool white and warm white LED, allowing you to select the light colour which is best suited to the design of your kitchen.
- > The fittings daisy chain together meaning a maximum of 10 fittings can be run from 1 x 15W driver (6 fittings if connected individually).
- > Daisy chain non sensor fittings into one sensor fitting for synchronised switching of all lighting in the run via the integrated touch sensor.
- > The touch sensor illuminates blue when the light is off for visibility.
- > Slimline, discreet fitting.
- > The aluminium finish and design of this fitting makes it ideal for contemporary kitchens.



Code	Wattage	LED Colour	Qty	Lumens	Driver	RRP
01.1000.0610	2.4W	Cool White (5670K)	1	115Lm	■	£16.20
01.1000.0612	4.8W	Cool White (5670K)	2	115Lm	included	£53.40
01.1000.0613	7.2W	Cool White (5670K)	3	115Lm	included	£69.48
01.1000.0620	2.4W	Warm White (3000K)	1	73Lm	■	£16.20
01.1000.0622	4.8W	Warm White (3000K)	2	73Lm	included	£53.40
01.1000.0623	7.2W	Warm White (3000K)	3	73Lm	included	£69.48
01.1001.0610	2.5W	Cool White (5670K)	1	115Lm	■	£23.76
01.1001.0612	5W	Cool White (5670K)	2	115Lm	included	£60.96
01.1001.0613	7.5W	Cool White (5670K)	3	115Lm	included	£77.04
01.1001.0620	2.5W	Warm White (3000K)	1	73Lm	■	£22.20
01.1001.0622	5W	Warm White (3000K)	2	73Lm	included	£59.40
01.1001.0623	7.5W	Warm White (3000K)	3	73Lm	included	£75.48

Without Touch Sensor



With Touch Sensor

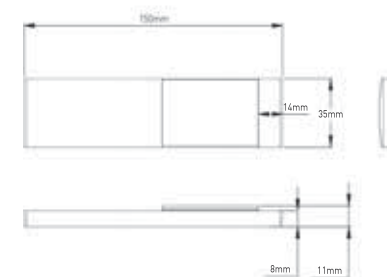

Accessories - Non-sensor

- Touch on/off switch (SE7004AL) Page 106
- Under cabinet IR swipe on/off sensor (SE40516) Page 105
- IR swipe on/off sensor switch (SE40517) Page 106
- IR on/off sensor switch & dimmer (SE40520) Page 105
- LED Dimming Remote Control (SE40581) Page 108
- Dimming remote control & receiver (SE40670 & SE40682/4) Page 109

Accessories - sensor

- 2.5m extension cable (SE9009) - £2.04

Under Cabinet Spot Lighting >

Genus LED Triangle Light

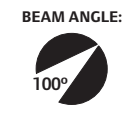
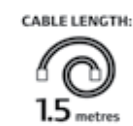
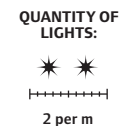
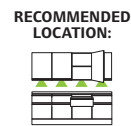
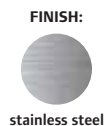

'traditional LED lighting'

- > Stainless steel triangle light with standard SMD LED chips.
- > Extremely long lamp life of approximately 15 years.
- > Energy saving, each fitting runs at only 1.4W.
- > Stainless steel finish and cool white LED, perfect for contemporary kitchen designs.
- > The angled aspect of a triangle light fitting means the light is directed forward onto the worktop.
- > The centre of the fitting containing the LED's simply pop's out so can easily be replaced if required.



Code	Wattage	LED Colour	Qty	Lumens	Driver	RRP
SE11010SSCW	1.4W	Cool White (4000K)	1	72Lm	■	£16.92
SE11010SSCWK2	2.8W	Cool White (4000K)	2	72Lm	included	£48.84
SE11010SSCWK3	4.2W	Cool White (4000K)	3	72Lm	included	£65.76

LED Triangle Light

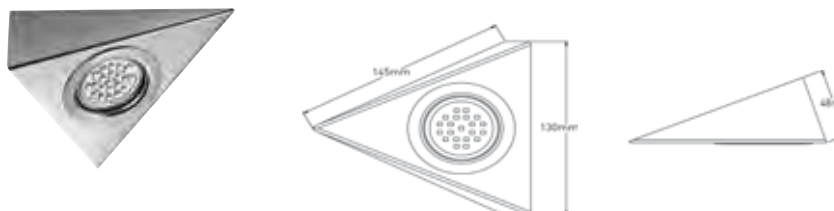

Accessories

- 2.5m extension cable (SE9009) - £2.04
- Under cabinet IR swipe on/off sensor (SE40516) Page 105
- IR swipe on/off sensor switch (SE40517) Page 106
- IR on/off sensor switch & dimmer (SE40520) Page 105
- LED Dimming Remote Control (SE40581) Page 108
- Dimming remote control & receiver (SE40670 & SE40682/4) Page 109

Under Cabinet Spot Lighting >

Genus LED Surface Light

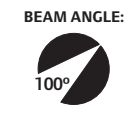
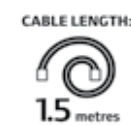
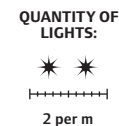
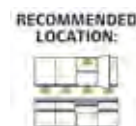
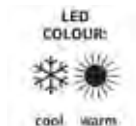
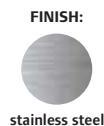

'traditional LED lighting'

- > Stainless steel recessed/surface light with standard SMD LED chips.
- > The fitting comes with the collar, however this can be removed if you wish to recess the fitting.
- > Extremely long lamp life of approximately 15 years.
- > Energy saving, each fitting runs at only 1.4W.
- > Stainless steel finish and cool white LED, perfect for contemporary kitchen designs.
- > The centre of the fitting containing the LED's simply pop's out so can easily be replaced if required.



Code	Wattage	LED Colour	Qty	Lumens	Driver	RRP
SE11025SSCW	1.4W	Cool White (4000K)	1	72Lm		£16.44
SE11025SSWW	1.4W	Warm White (3000K)	1	50Lm		£16.92
SE11025SSCWK2	2.8W	Cool White (4000K)	2	72Lm	included	£47.64
SE11025SSCWK3	4.2W	Cool White (4000K)	3	72Lm	included	£63.96

LED Surface/Recessed Light

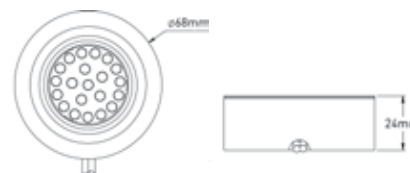

Cut-out size: Ø60mm

Accessories

2.5m extension cable (SE9009) - £2.04
PIR in cabinet on/off sensor (SE2015000) Page 107
Under cabinet IR swipe on/off sensor (SE40516) Page 105
IR swipe on/off sensor switch (SE40517) Page 106

In cabinet on/off switch (SE40518) Page 107
IR on/off sensor switch & dimmer (SE40520) Page 105
LED Dimming Remote Control (SE40581) Page 108
Dimming remote control & receiver (SE40670 & SE40682/4) Page 109

Under Cabinet Spot Lighting >

Genus LED Rectangle Light

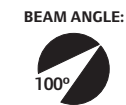
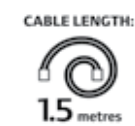
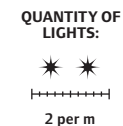
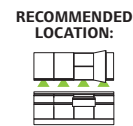
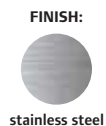

'traditional LED lighting'

- > Stainless steel rectangle light with standard SMD LED chips.
- > Extremely long lamp life of approximately 15 years.
- > Energy saving, each fitting runs at only 1.4W.
- > Stainless steel finish and cool white LED, perfect for contemporary kitchen designs.
- > The angled aspect of a rectangle light fitting means the light is directed forward onto the worktop.
- > The centre of the fitting containing the LED's simply pop's out so can easily be replaced if required.



Code	Wattage	LED Colour	Qty	Lumens	Driver	RRP
SE11040SSCW	1.4W	Cool White (4000K)	1	72Lm	■	£16.92
SE11040SSCWK2	2.8W	Cool White (4000K)	2	72Lm	included	£48.84
SE11040SSCWK3	4.2W	Cool White (4000K)	3	72Lm	included	£65.76

LED Rectangle Light

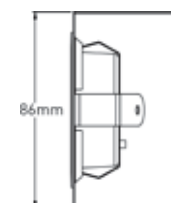

Accessories

- 2.5m extension cable (SE9009) - £2.04
- Under cabinet IR swipe on/off sensor (SE40516) Page 105
- IR swipe on/off sensor switch (SE40517) Page 106
- IR on/off sensor switch & dimmer (SE40520) Page 105
- LED Dimming Remote Control (SE40581) Page 108
- Dimming remote control & receiver (SE40670 & SE40682/4) Page 109

Under Cabinet Spot Lighting >

GX53 Circa LED Recessed/Surface Light

FINISH:



stainless steel



LAMP LIFE:



QUANTITY OF LIGHTS:

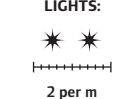

CABLE LENGTH:



BEAM ANGLE:



'mains LED spot lighting for simple installation'

- > Stainless steel surface light with a 50 diode GX53 lamp.
- > The collar can be removed from the fitting if you wish to recess.
- > This fitting runs at 240V so no driver is required.
- > Extremely simple connection system, the mains cable has a connector attached which plugs into the SE11175 (see accessories below). When this accessory is used these fittings can be installed by anyone.
- > 50 diodes integrated for optimum light output.
- > The lamps are simple to replace via a simple twist and lock mechanism.



Code	Wattage	LED Colour	LED Qty	Lumens	Connection	RRP
SE10151CW	3W	Cool White (5800K)	50	250Lm	240V	£31.20
SE10151WW	3W	Warm White (3000K)	50	245Lm	240V	£35.04

SE10151CW

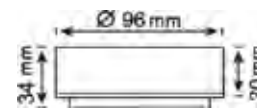

Surface mounted

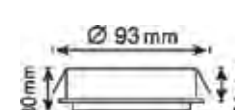

Recessed

Cut-out: Ø84mm

SE11175 - 6 way distribution block with plug



Accessories

- GX53 2m Extension Cable (SE11172) - £3.48
- GX53 6Way Distributor Block with 1.5m Cable & Plug (SE11175) - £11.16

Additional Lamps

- LED GX53 Lamp - Cool White (SE10156CW) - £16.60
- LED GX53 Lamp - Warm White (SE10156WW) - £19.80

Under Cabinet Spot Lighting >

GX53 Trigon LED Triangle Light

FINISH:



stainless steel



cool warm

LAMP LIFE:



12.5 years

RECOMMENDED LOCATION:



QUANTITY OF LIGHTS:



2 per m

CABLE LENGTH:



1.5 metres

BEAM ANGLE:



120°

'no LED driver required for simple installation'

- > Stainless steel triangle light with a 50 diode GX53 lamp.
- > This fitting runs at 240V so no driver is required.
- > Extremely simple connection system, the mains cable has a connector attached which plugs into the SE11175 (see accessories below). When this accessory is used these fittings can be installed by anyone.
- > 50 diodes integrated for optimum light output.
- > The angled aspect of a triangle light fitting means the light is directed forward onto the worktop.
- > The lamps are simple to replace via a simple twist and lock mechanism.



Code	Wattage	LED Colour	LED Qty	Lumens	Connection	RRP
SE10152CW	3W	Cool White (5800K)	50	250Lm	240V	£33.84
SE10152WW	3W	Warm White (3000K)	50	245Lm	240V	£37.80

SE10152CW

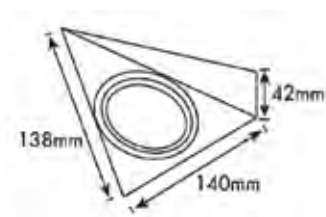
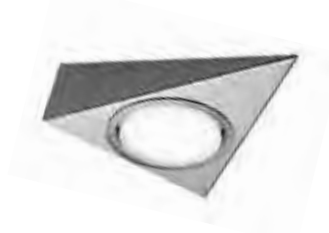

SE11175 - 6 way distribution block with plug



Accessories

GX53 2m Extension Cable (SE11172) - £3.48
GX53 6Way Distributor Block with 1.5m Cable & Plug (SE11175) - £11.16

Additional Lamps

LED GX53 Lamp - Cool White (SE10156CW) - £16.60
LED GX53 Lamp - Warm White (SE10156WW) - £19.80

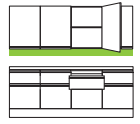

Under Cabinet Strip Lighting >



Under Cabinet Strip Lighting >

Connex SLS LED Strip Light

NEW

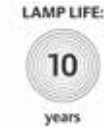

'the LED alternative to T5 with no visible LEDs'

- > The Connex features SLS (surface light source) technology meaning the LED points are not seen. The diffused look of the LED's produces the same look and light output of a T5 fluorescent.
- > Mains fitting for ultra simple installation.
- > Available in warm white LED, the perfect LED strip light for the more traditional kitchen design.
- > Save on energy bills. These LED options run at a much lower wattage than the fluorescent equivalents.
- > The fittings can be directly interlinked to form a continuous run of light.
- > Each fitting is supplied with 1m of mains cable for simple installation (no driver required).
- > When interlinking the Connex a maximum length of 2.5m can be achieved by continuous linking.



Code	Wattage	Length	Lumens	Kelvin	Connection	RRP
SE10173W0	4.4W	270mm	450Lm	3000K	240V	£22.68
SE10183W0	6.4W	396mm	540Lm	3000K	240V	£24.48
SE10193W0	8.4W	524mm	720Lm	3000K	240V	£29.28
SE10203W0	10.2W	623mm	900Lm	3000K	240V	£31.68

SLS
surface light source

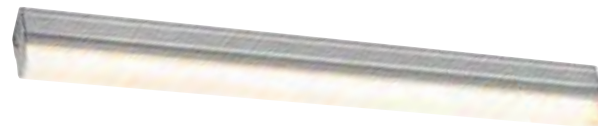

270/396/524/623mm



Under Cabinet Strip Lighting >

Click Slideline Track System With Sensor

FINISH:
aluminium

LED COLOUR:
cool warm

LAMP LIFE:
125 years

RECOMMENDED LOCATION:

BEAM ANGLE:
35°

'customise your lighting'

- > Three lengths of the track available. However the product can be cut to size if required.
- > Effective lighting solution, the lamps click on and off of the track meaning you can add or remove lights as required simply.
- > A great solution to easily show clients the effect of both cool white and warm white LED.
- > Slide the lamps along the track to where you are working in the kitchen to heighten the level of lighting.
- > Choose a solution to suit you; choose the length of track, choose either round or square lamps in either cool or warm white LED.
- > High definition LED for a more intense light output.
- > Integrated infra-red sensor. To maintain hygiene levels the lights can be switched on/off by simply swiping your hand past the sensor.

* When calculating the driver requirement for this product, please allow an additional 1W for the sensor.



HD LED Click Slideline System

Code	Length	Qty per pack	Cable	Driver	RRP
SE9056HD	600mm	1	1.5m included	■	£18.72
SE9057HD	900mm	1	1.5m included	■	£23.04
SE9058HD	1200mm	1	1.5m included	■	£25.80

HD LED Click Slideline Lamp

Code	Wattage	LED Colour	Shape	Lumens	Driver	RRP
SE9055HDCW	1.65W	Cool White (5000K)	Round	85Lm	■	£21.72
SE9055HDSCW	2W	Cool White (5000K)	Square	85Lm	■	£22.32
SE9055HDRWW	1.65W	Warm White (3200K)	Round	80Lm	■	£21.72
SE9055HDSWW	2W	Warm White (3200K)	Square	80Lm	■	£22.32

HD LED Click Slideline System With Sensor



Track and lamps are purchased separately

HD LED Click Slideline Lamp



Accessories

2.5m extension cable (SE9009) - £2.04

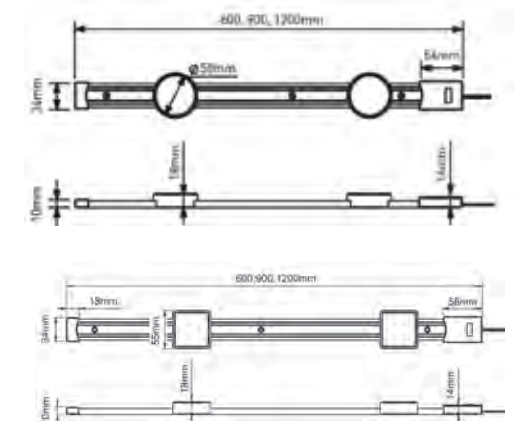

Under Cabinet Strip Lighting >

Linca HD LED Linkable Strip Light

FINISH:



aluminium

LED COLOUR:



cool warm

LAMP LIFE:



years

RECOMMENDED LOCATION:



CABLE LENGTH:



2.5 metres

DIMMABLE:



BEAM ANGLE:



'it's all about the brightness'

- > Interlinkable fittings to create a continuous run of high output task lighting with no breaks in the light.
- > The low wattage of the product means several units can be linked together and run from one driver.
- > Create a maximum continuous run of 4.2m and run from one 50W driver.
- > Available in both cool and warm white LED to suit both contemporary and traditional kitchen designs.
- > With a width of only 22.6mm and a depth of 9.4mm this slim line and discreet fitting is perfect where invisible lighting is required.
- > High definition LED's for optimum light output.



Code	Length	Wattage	LED Colour	Lumens	Driver	RRP
SE9070HDCW	400mm	4.6W	Cool White (5000K)	433Lm	■	£39.84
SE9070HDWW	400mm	4.6W	Warm White (3000K)	372Lm	■	£39.84
SE9072HDCW	600mm	7.1W	Cool White (5000K)	676Lm	■	£56.40
SE9072HDWW	600mm	7.1W	Warm White (3000K)	578Lm	■	£56.40

Linkable



Slimline

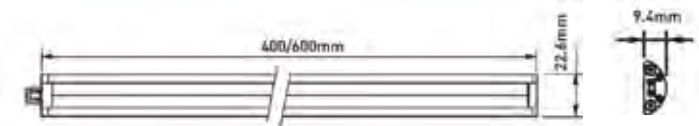

Accessories

2.5m extension cable (SE9009) - £2.04
 Under cabinet IR swipe on/off sensor (SE40516) Page 105
 IR swipe on/off sensor switch (SE40517) Page 106

IR on/off sensor switch & dimmer (SE40520) Page 105
 LED Dimming Remote Control (SE40580) Page 108
 Dimming remote control & receiver (SE40675 & SE40682/4) Page 109

Under Cabinet Strip Lighting >

Quadra PLUS - B LED Bar Light

FINISH:



aluminium

LED COLOUR:



cool warm

LAMP LIFE:



years

RECOMMENDED LOCATION:



CABLE LENGTH:



1.5 metres

DIMMABLE:



BEAM ANGLE:



120°

'sleek and discreet with a spot lighting effect'

- > The lens on this fitting has a triphosphor coating, creating an even spread of light.
- > Available in both cool white and warm white LED, allowing you to select the light colour which is best suited to the design of your kitchen.
- > Slimline, discreet fitting.
- > Modular product, the fittings are linkable to create a continuous run of light to suit your cabinets.
- > The aluminium finish and design of this fitting makes it ideal for contemporary kitchens.
- > Use with a range of external sensor switches/controllers to operate the lighting as required.



Code	Wattage	Length	LED Colour	LED sections	Lumens	Driver	RRP
01.1002.0610	2.4W	500mm	Cool White (5670K)	2	167Lm	■	£20.76
01.1003.0610	3.6W	600mm	Cool White (5670K)	3	250Lm	■	£27.72
01.1004.0610	4.8W	800mm	Cool White (5670K)	4	323Lm	■	£35.52
01.1005.0610	4.8W	900mm	Cool White (5670K)	4	323Lm	■	£36.36
01.1002.0620	2.4W	500mm	Warm White (3000K)	2	133.6Lm	■	£21.12
01.1003.0620	3.6W	600mm	Warm White (3000K)	3	200Lm	■	£27.72
01.1004.0620	4.8W	800mm	Warm White (3000K)	4	258.4Lm	■	£35.52
01.1005.0620	4.8W	900mm	Warm White (3000K)	4	258.4Lm	■	£36.36

900mm Quadra Bar Light



Accessories

Quadra Plus Link Cable – 80mm (00.1000.0000) - £1.56
2.5m extension cable (SE9009) - £2.04

Touch on/off switch (SE7004AL) Page 106
Under cabinet IR swipe on/off sensor (SE40516) Page 105

IR swipe on/off sensor switch (SE40517) Page 106
IR on/off sensor switch & dimmer (SE40520) Page 105
LED Dimming Remote Control (SE40581) Page 108
Dimming remote control & receiver (SE40670 & SE40682/4) Page 109

Under Cabinet Strip Lighting >

Topaz Touch Switch Profile

FINISH:



aluminium

LED COLOUR:



cool warm

LAMP LIFE:



years

RECOMMENDED LOCATION:



CABLE LENGTH:



1.5 metres

BEAM ANGLE:



90°

'various options with functionality built-in'

- > This fitting has an integrated on/off touch switch.
- > Touch switch outer illuminates blue when the lights are off for visibility.
- > Fitting can be recessed or surface mounted under cabinets.
- > Available in both cool white and warm white LED. Create the perfect solution.
- > Four standard lengths available.
- > Contains High Definition LED's.

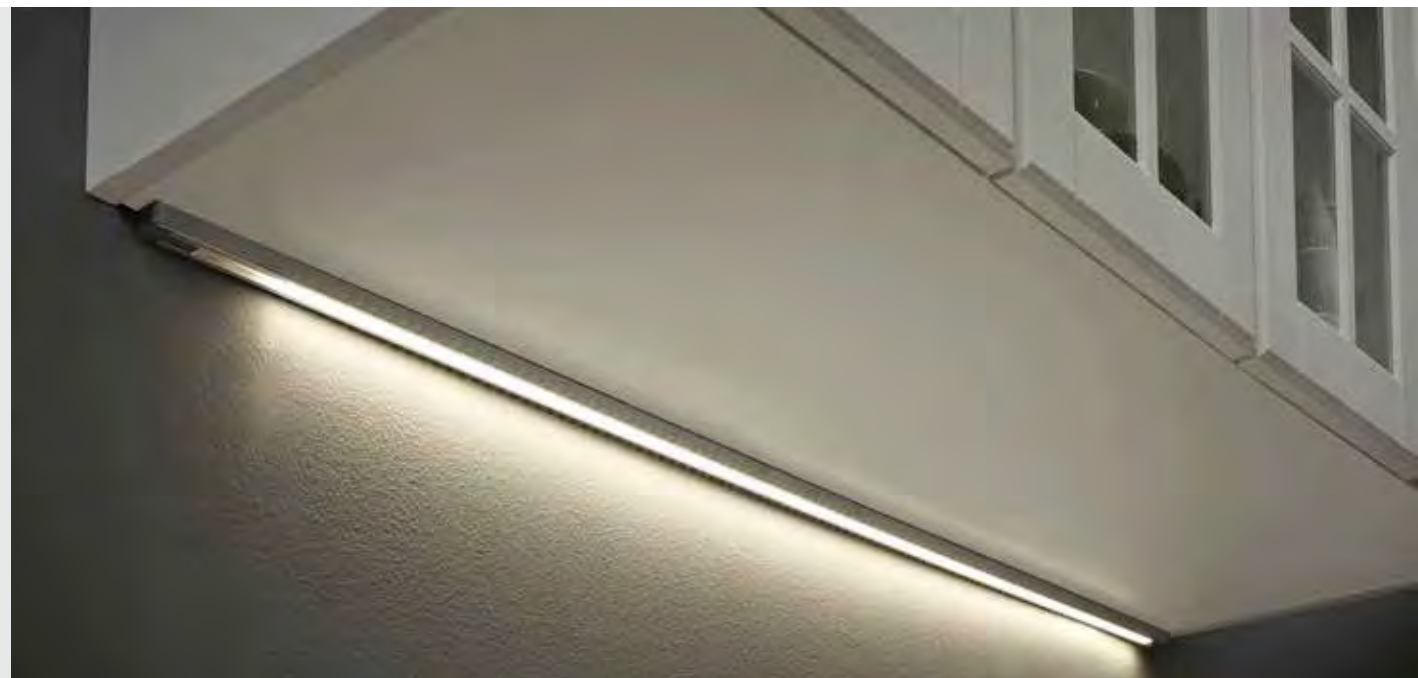

Code	Length	Wattage	LED Colour	Lumens	Driver	RRP
SE7500HDCW	460mm	2.W	Cool White (5000K)	110Lm	■	£ 41.76
SE7500HDWW	460mm	2W	Warm White (3000K)	66Lm	■	£41.76
SE7505HDCW	560mm	2.5W	Cool White (5000K)	133Lm	■	£48.72
SE7505HDWW	560mm	2.5W	Warm White (3000K)	80Lm	■	£48.72
SE7510HDCW	760mm	3.5W	Cool White (5000K)	175Lm	■	£62.76
SE7510HDWW	760mm	3.5W	Warm White (3000K)	105Lm	■	£62.76
SE7515HDCW	1160mm	5.5W	Cool White (5000K)	292Lm	■	£90.96
SE7515HDWW	1160mm	5.5W	Warm White (3000K)	176Lm	■	£90.96

Touch Switch Profile



Surface mounted

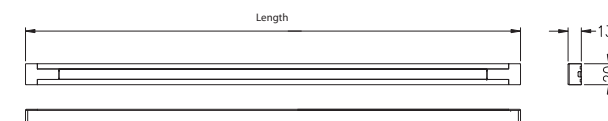

Recess mounted



Accessories

2.5m extension cable (SE9009) - £2.04

Under Cabinet Strip Lighting >

Triplo

Dimming Under Cabinet Light

FINISH:



aluminium

LED COLOUR:



cool

LAMP LIFE:



years

RECOMMENDED LOCATION:



CABLE LENGTH:



2 metres

DIMMABLE:



BEAM ANGLE:



'all in one, on/off switch PLUS dimming'

- > With its integrated dimming, on/off switch this fitting has functionality built-in.
- > Sensor illuminates warm white for visibility.
- > The fitting is angled so the light will be directed outwards on the worktop.
- > Modern aluminium finish and cool white LED great for contemporary kitchens.
- > A high quantity of High Definition LED diodes integrated for optimum light output.
- > Slimline fitting, ideal for that streamlined look.



Code	Wattage	Length	LED Qty	Kelvin	Lumens	Driver	RRP
SE7100HDCW	3.5W	450mm	30	5000K	110Lm	■	£68.04
SE7105HDCW	4.9W	600mm	45	5000K	166Lm	■	£ 80.04
SE7110HDCW	7.2W	900mm	72	5000K	286Lm	■	£104.76
SE7115HDCW	10.7W	1200mm	99	5000K	390Lm	■	£ 127.56

Dimming on/off switch illuminated

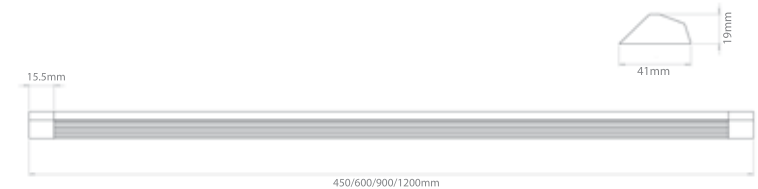

Accessories

2.5m extension cable (SE9009) - £2.04

Fino Surface Mounted Profile



'customisable lighting'

- > Choose from our range of flexible strip lighting to create the perfect solution for your customer.
- > Select the HD LED flexible strip light for the ultimate light output, use under a cabinet to create a continuous run of streamlined task lighting.
- > The profile is extremely slim to create the ultimate discreet lighting solution.
- > Aluminium profile with a frosted cover.
- > The profile protects the flexible strip light, protecting from dust and ultimately giving a more professional finish.
- > A versatile solution as both the profile and flexible strip can be cut to length.
- Perfect when you have bespoke sizes to meet.
- > Butt lengths of the profile together if a longer run is required.
- > End caps and mounting brackets included.



Code	Length	LED Strip	Cable	Driver	RRP
10.1000.0600	1m	Profile only	N/A	N/A	£11.40
10.1004.0600	2m	Profile only	N/A	N/A	£21.72

Flexible Strip Lighting sold separately - see pages 76-80 for options.



Surface Mounted
Aluminium Profile

End caps and mounting
brackets included

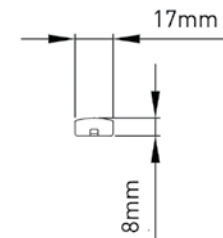

Additional Components

- 2 x End caps for Surface Mounted Profile (10.1016.0602) - £1.08
- 2 x Mounting Brackets for Surface Mounted Profile (10.1018.0602) - £1.08



Under Cabinet Strip Lighting >

Albus LED Strip Light

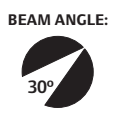
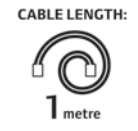
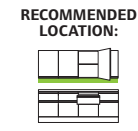
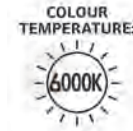
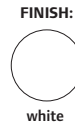

'ultimate ease of installation'

- > The fittings can be directly interlinked to form a continuous run of light.
- > Mains LED fitting, no external driver required.
- > Integrated on/off switch on each fitting. Switch via one fitting when in a run.
- > Each fitting contains a high number of LED's for optimum light output.
- > Angled fitting for optimum illumination of the kitchen worktop.
- > Available in cool white LED, a mains powered LED strip light which looks superb in contemporary kitchens.
- > Each fitting is supplied with a 1m cable and plug for simple installation.



Code	Wattage	Length	No of LEDs	Lumens	Connection	RRP
SE12250	2.7W	250mm	46	205Lm	240V	£34.44
SE12330	3.6W	330mm	65	263Lm	240V	£39.48
SE12550	6.8W	550mm	121	517Lm	240V	£55.44

LED Strip Light



Accessories

Male & Female Connector (SE12001) - £4.08

Allows you to wire a length of mains cable between 2 fittings to link them together.

500mm Link Cable (SE12005) - £2.88

To link two units together where direct interlinking is not suitable.

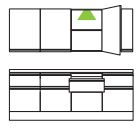





In Cabinet Lighting >



Incline Rechargeable LED Strip Light

NEW

FINISH:  aluminium
LED COLOUR:  cool
COLOUR TEMPERATURE:  4500K
RECHARGEABLE: 
BEAM ANGLE:  100°

'light angled to prevent glare'

- > Features an integrated PIR sensor which automatically switches the light on when the cabinet door is opened.
- > If movement is not detected for 30 seconds or more the light will temporarily switch off to reduce wastage of the battery power.
- > This fitting is available in 5 standard lengths, however can be cut down if required.
- > No electrical installation required. Contains a Lithium-ion rechargeable battery.
- > The run time of the product is 6.5 months based on 2.5 minutes of use per day. The charging time is 4.5 hours on average.
- > Recharge the unit using the 03.2005.0800 pluggable USB charger.
- > Cool white LED for optimum light output.



Code	Length	Wattage	LED Qty	LED Colour	Cut Length	Lumens	RRP
SE20242C0	350mm	0.5W	6pcs	Cool White	N/A	27Lm	£78.24
SE20252C0	550mm	0.6W	10pcs	Cool White	100mm*	48Lm	£80.28
SE20262C0	750mm	0.8W	14pcs	Cool White	300mm*	70Lm	£94.56
SE20272C0	850mm	0.9W	16pcs	Cool White	400mm*	80Lm	£96.60
SE20282C0	950mm	1W	18pcs	Cool White	400mm*	95Lm	£99.84

Accessories		
03.2005.0800	Pluggable USB Charger with 5m USB charging cable	£9.72

* Maximum cut length (an amount has to be cut from each end of the fitting).

Incline Wardrobe Light & USB Charger



Pluggable USB Charger (purchase seperately) 03.2005.0800

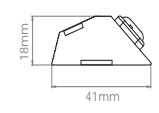
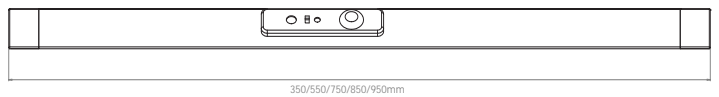

Solus

Rechargeable Angled Light

NEW

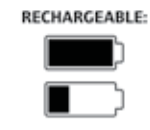

'so simple to install and maintain'

- > Contains a rechargeable Lithium-ion battery. No electrical installation required.
- > The product is cable free for ease of installation.
- > Rechargeable via a pluggable USB charger.
- > Angled surface light to reduce glare.
- > Features an integrated PIR sensor which automatically switches the light on when the cabinet door is opened.
- > The detection range of the PIR is 2m, meaning the fitting can be positioned as required inside the cabinet.
- > If movement is not detected for 30 seconds or more the light will temporarily switch off to reduce wastage of the battery power.
- > The run time of the product is 8 months based on 2.5 minutes of use per day. The charging time is 6.5 hours on average.
- > The product has an additional on/off switch for optional use.



Code	Wattage	LED Qty	LED Colour	Quantity	Lumens	RRP
SE20061C0	0.7W	14pcs	Cool White	1	52Lm	£41.88
SE20061C3	2.1W	14pcs (PF)	Cool White	3	52Lm (PF)	£133.92

Accessories		
SE2007000	Pluggable USB Charger with 5m cable	£8.04

PF - per fitting

Pack includes 3 fittings and a USB charger.

Surface mounted with integrated PIR



Charging point & on/off switch



Rechargeable battery via USB Charger.
Charge using the plug provided or via the USB cable (using a laptop for example).

Red indicator light shows that the unit is charging.

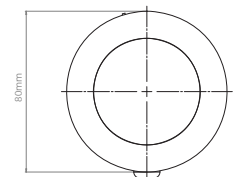

Mounting bracket included for installation

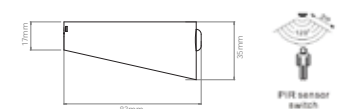

In Cabinet Lighting >

Mimas

Rechargeable LED Light

NEW

FINISH:  aluminium
LED COLOUR:  cool
COLOUR TEMPERATURE:  4500K
RECHARGEABLE: 
BEAM ANGLE:  120°

'lighting just where you need it'

- > Contains a rechargeable Lithium-ion battery. No electrical installation required.
- > The product is cable free for ease of installation.
- > Features an integrated PIR sensor which automatically switches the light on when the cabinet door is opened.
- > If movement is not detected for 30 seconds or more the light will temporarily switch off to reduce wastage of the battery power.
- > The PIR has a detection range of 2m, allowing you to place the fitting where you require in the cabinet.
- > The run time of the product is 8 months based on 2.5 minutes of use per day. The charging time is 6.5 hours on average.
- > Recharge the unit using the pluggable USB charger.
- > The product has an additional on/off switch for optional use.



Code	Wattage	LED Qty	LED Colour	Quantity	Lumens	RRP
SE20051C0	0.7W	14pcs	Cool White	1	37Lm	£51.36
SE20051C3	2.1W	14pcs (PF)	Cool White	3	37Lm (PF)	£162.48

Accessories

SE2007000	Pluggable USB Charger with 5m cable					£8.04
-----------	-------------------------------------	--	--	--	--	-------

PF - per fitting

Pack includes 3 fittings and a USB charger.

Integrated PIR

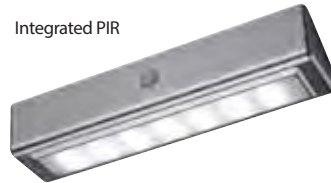

Charging point & on/off switch



Pluggable USB Charger (purchase separately) SE2007000

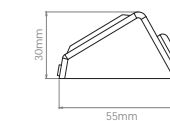
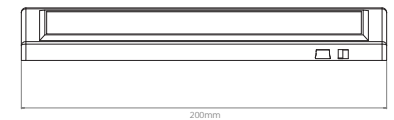

Mounting bracket included for installation

In Cabinet Lighting >

Cona In Cabinet Light with PIR

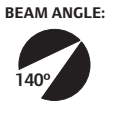
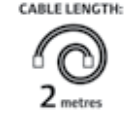

'ultra bright internal lighting'

- > Integrated PIR Sensor. The PIR has a detection range of 2m meaning the fitting can be mounted as required in the cabinet.
- > Various lengths to ensure great coverage for all cabinet sizes.
- > Angled light source for optimum illumination of the cabinet interior.
- > The high number of HD LED diodes integrated ensures an even illumination.
- > Cool white LED, the brightest light source.



Code	Wattage	Length	No of LEDs	Lumens	Driver	RRP
SE7200HDCW	2.7W	400mm	36	92Lm	■	£54.84
SE7205HDCW	3.6W	550mm	48	130Lm	■	£63.36
SE7208HDCW	5.7W	850mm	78	239Lm	■	£85.56
SE7210HDCW	6.3W	950mm	87	271Lm	■	£92.40
SE7215HDCW	7.8W	1150mm	108	351Lm	■	£109.56

With PIR

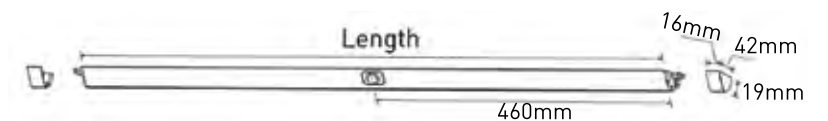

Accessories

2.5m extension cable (SE9009) - £2.04

Inca In Cabinet Light

FINISH:
aluminium

LED COLOUR:
cool warm

LAMP LIFE:
25 years

RECOMMENDED LOCATION:

CABLE LENGTH:
1.5 metres

BEAM ANGLE:
60°

'lighting just where you need it'

- > Integrated PIR Sensor. The PIR has a detection range of 2m meaning the fitting can be mounted as required in the cabinet.
- > Fitting can be surface mounted or recessed.
- > Both cool white and warm white available, choose which best suits the cabinetry.
- > Slimline fitting, the ultimate solution for discreet interior lighting.



Code	Wattage	Length	LED Colour	Lumens	Driver	RRP
SE7400HDCW	3W	420mm	Cool White (5000K)	150Lm	■	£39.36
SE7400HDWW	3W	420mm	Warm White (3000K)	90Lm	■	£39.24
SE7405HDCW	4W	520mm	Cool White (5000K)	196Lm	■	£46.32
SE7405HDWW	4W	520mm	Warm White (3000K)	116Lm	■	£46.32

In Cabinet Light with PIR Sensor

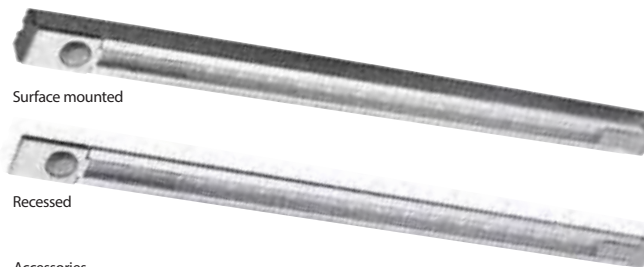

Accessories

2.5m extension cable (SE9009) - £2.04

Surface mounted

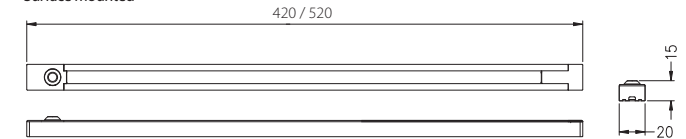

Recess mounted



Picca

In Cabinet Light With IR Sensor

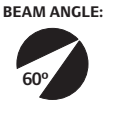
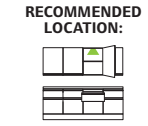
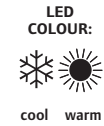

'make the most of your cabinet interior'

- > Integrated IR sensor on the front edge of the fitting, for on/off switching activated by the opening and closing of the cabinet door.
- > The light floods to the back of the cabinet for optimum illumination.
- > Cool white for maximum illumination, warm white for wooden carcasses .
- > High Definition LED's integrated.
- > Low wattage fittings – minimal energy usage.



Code	Wattage	Length	LED Colour	Lumens	Driver	RRP
SE9080HDCW	2W	430mm	Cool White (5000K)	85Lm	■	£39.84
SE9080HDWW	2W	430mm	Warm White (3200K)	80Lm	■	£39.84
SE9081HDCW	3W	580mm	Cool White (5000K)	120Lm	■	£49.68
SE9081HDWW	3W	580mm	Warm White (3200K)	110Lm	■	£49.68

In Cabinet light With IR Sensor Integrated

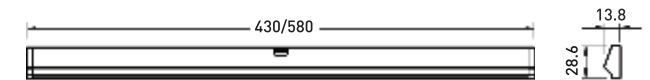

Accessories

2.5m extension cable (SE9009) - £2.04

In Cabinet Lighting >

Quadra PLUS - I LED In Cabinet Light

FINISH:



aluminium

LED COLOUR:



cool warm

LAMP LIFE:



years

RECOMMENDED LOCATION:



CABLE LENGTH:



1.5 metres

BEAM ANGLE:



120°

'neat and stylish lighting just where you need it'

- > The lens of the fitting has a Triphosphur coating to ensure an even spread of light.
- > IR sensor integrated on the front edge of the fitting, the light is activated on the opening of the cabinet door. When the door is closed the light will switch off.
- > Low wattage fitting – minimal energy usage.
- > Ideal for smaller cabinets.
- > Both cool white and warm white available, choose which best suits the cabinetry.



Code	Wattage	LED Colour	Lumens	Driver	RRP
03.1000.0610	2.5W	Cool White (5975Lm)	142Lm	■	£22.32
03.1000.0620	2.5W	Warm White (3050Lm)	74Lm	■	£22.20

In Cabinet Light



Accessories

2.5m extension cable (SE9009) - £2.04

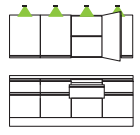

Over Cabinet Lighting >

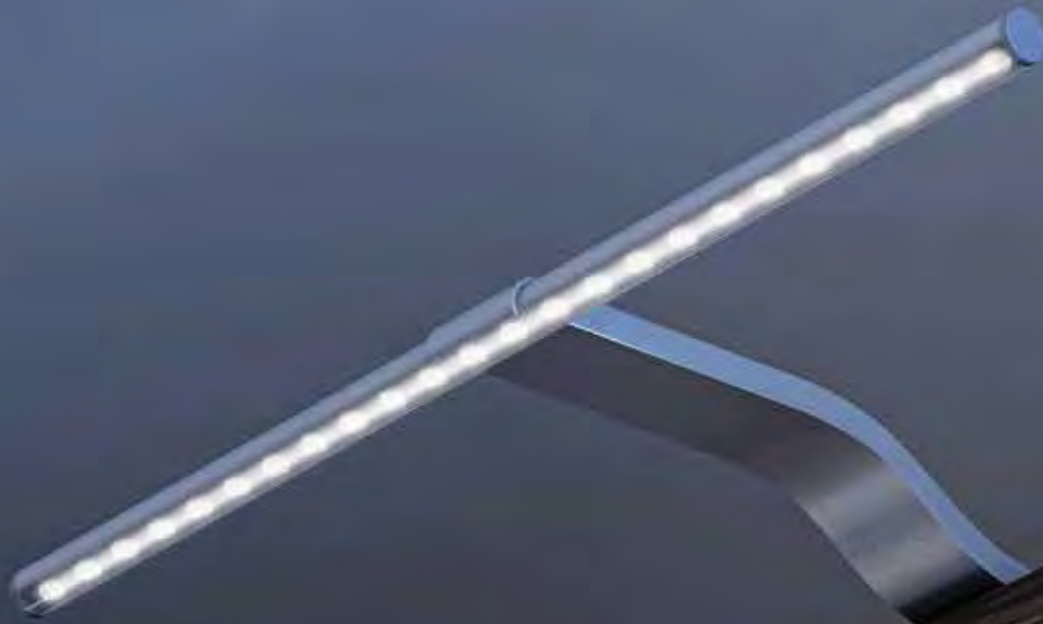

Asta Over Cabinet Light

FINISH:
aluminium

LED COLOUR:
cool warm

LAMP LIFE:
10 years

RECOMMENDED LOCATION:

CABLE LENGTH:
1.5 metres

DIMMABLE:

BEAM ANGLE:
80°

'optimum illumination of cabinet fronts'

- > Fitting has an adjustable head for optimum illumination of the cabinet front (adjusts by 25°).
- > Available in both cool white and warm white LED, allowing you to create the perfect mood lighting to suit your cabinetry.
- > 24 high definition LED diodes integrated in each fitting
- > The 335mm head of the fitting ensures an even illumination across the cabinet front.
- > Can also be used above wardrobes.

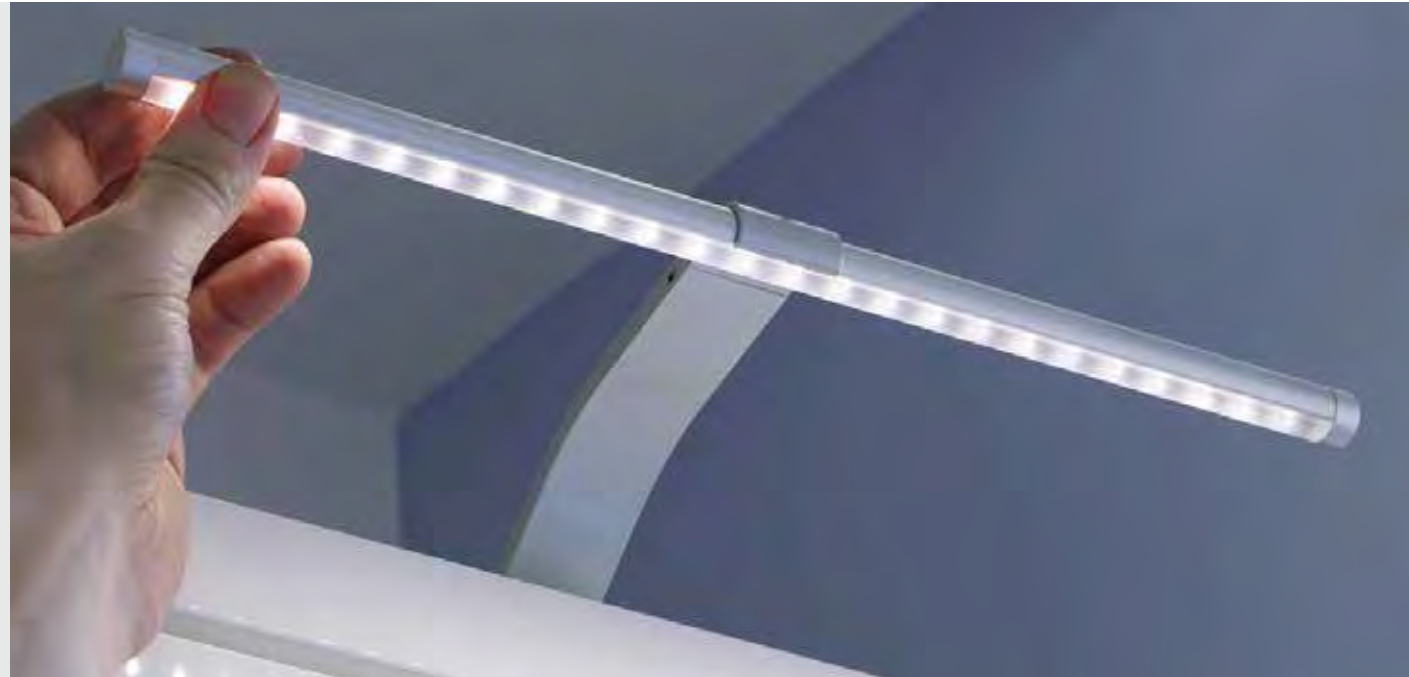

Code	Wattage	LED Colour	Qty	Lumens	Driver	RRP
SE9015HDCW	1.65W	Cool White (5000K)	1	85Lm	■	£25.20
SE9015HDCWK2	3.3W	Cool White (5000K)	2	85Lm	included	£68.64
SE9015HDCWK3	4.95W	Cool White (5000K)	3	85Lm	included	£93.84
SE9015HDWW	1.65W	Warm White (3200K)	1	80Lm	■	£25.68
SE9015HDWWK2	3.3W	Warm White (3200K)	2	80Lm	included	£72.96
SE9015HDWWK3	4.95W	Warm White (3200K)	3	80Lm	included	£98.64

HD LED Over Cabinet Light

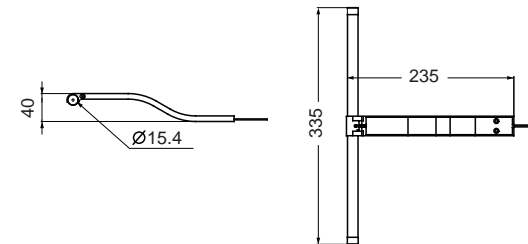

Accessories

- 2.5m extension cable (SE9009) £2.04
- IR swipe on/off sensor switch (SE40517) Page 106
- Under cabinet IR swipe on/off sensor (SE40516) Page 105
- IR on/off sensor switch & dimmer (SE40520) Page 105
- LED Dimming Remote Control (SE40580) Page 108
- Dimming remote control & receiver (SE40675 & SE40682/4) Page 109

Over Cabinet Lighting >

Quadra PLUS - O LED Over Cabinet Light

FINISH:



aluminium

LED COLOUR:



cool warm

LAMP LIFE:



years

RECOMMENDED LOCATION:



CABLE LENGTH:



1.5 metres

DIMMABLE:



BEAM ANGLE:



120°

'it's all about the doors'

- > The lens on this fitting has a Triphosphor coating, creating an even spread of light from the LED diodes integrated.
- > Use this fitting to create mood lighting by illuminating the cabinet fronts.
- > Both cool white and warm white available, choose which best suits the cabinetry.
- > Long lamp life and extremely low energy consumption.
- > This fitting can also be used above wardrobes.

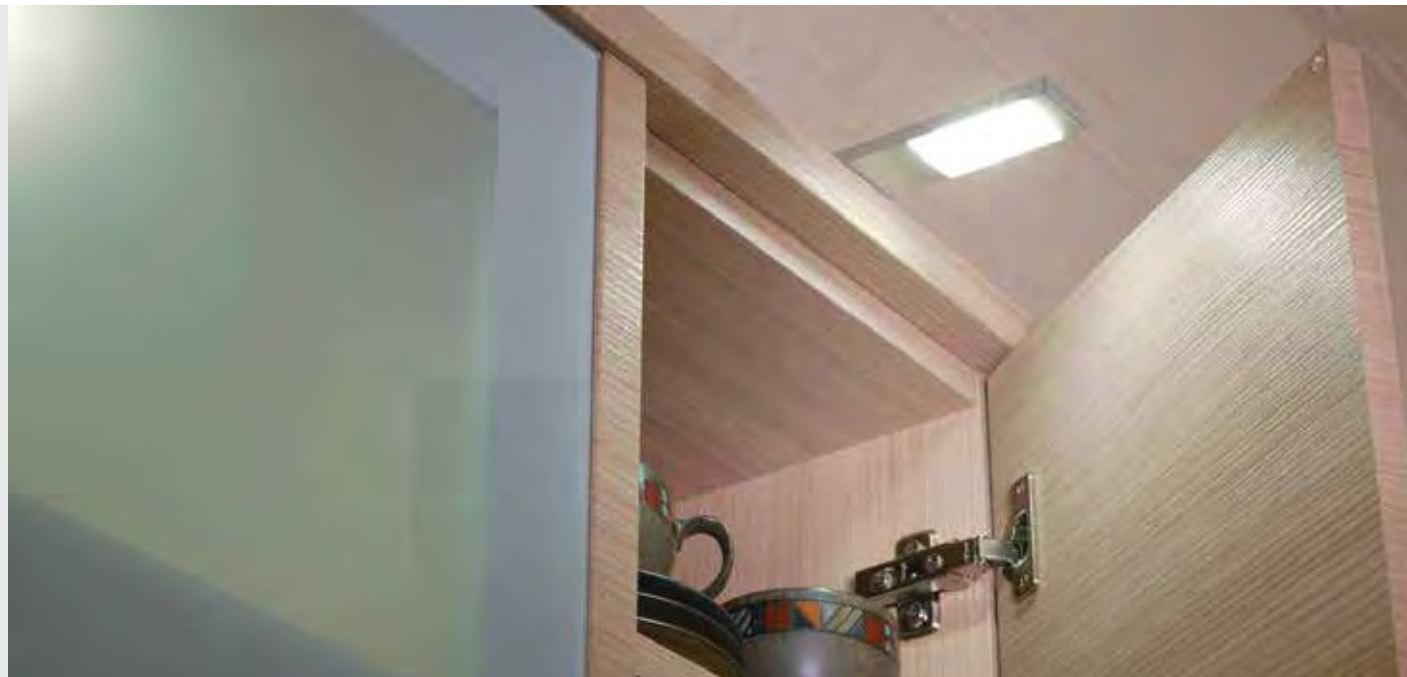

Code	Wattage	LED Colour	Qty	Lumens	Driver	RRP
04.1000.0610	2.4W	Cool White (5975Lm)	1	142Lm	■	£16.68
04.1000.0620	2.4W	Warm White (3050K)	1	74Lm	■	£16.68
04.1000.0612	4.8W	Cool White (5975Lm)	2	142Lm	included	£60.96
04.1000.0622	4.8W	Warm White (3050K)	2	74Lm	included	£59.40
04.1000.0613	7.2W	Cool White (5975Lm)	3	142Lm	included	£77.04
04.1000.0623	7.2W	Warm White (3050K)	3	74Lm	included	£75.48

Quadra LED Over Cabinet Light

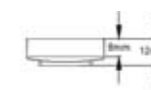
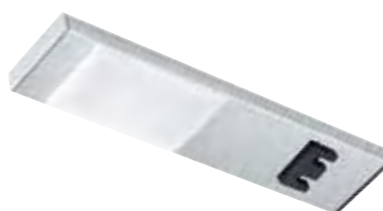

Accessories

- 2.5m extension cable (SE9009) - £2.04
- IR swipe on/off sensor switch (SE40517) Page 106
- LED Dimming Remote Control (SE40581) Page 108
- Dimming remote control & receiver (SE40670 & SE40682/4) Page 109

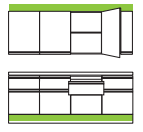

Flexible Strip Lighting >



Flexible Strip Lighting >

DuoFlex Flexible Strip

NEW



'seamlessly mix colour to create the perfect mood'

- > The DuoFlex brings real flexibility to the flexible strip light range. With only one flexible strip the LED colour can be set from warm white through the full spectrum to cool white.
- > Self-adhesive 3M backing allows for quick and simple installation.
- > Male and female ends on the strip allow you to create the length required.
- > The strip can be cut to length, scissor marks on the product mark where it is suitable to cut (every 165mm).
- > Operate using a remote control or inline switch. One remote control can be synced to up to 11 receivers.
- > A maximum length of 6m of the DuoFlex can be run from each receiver.
- > Ten brightness levels of the LED, dim or brighten by 10%.
- > Use this product for a variety of applications such as on the underside of the bed, around the headboard or above wardrobes to up-light.



Code	Wattage	Length	LED No.	Colour Temp.	Lumens	Driver	RRP
SE10011D0	3.75W	1000mm	72	2700-5000K	282-300Lm	■	£45.48
SE10021D0	7.5W	2000mm	144	2700-5000K	282-300Lm	■	£85.08

Packs

Code	Wattage	Length	Cable	Controller	Driver	RRP
SE10053D1	7.5W	2000mm	2 x 2.5m	Inline switch	included in pack	£141.48
SE10073D1	7.5W	2000mm	2 x 2.5m	Remote & Receiver	Included in pack	£181.20

SE1003000 - DuoFlex Remote Control (see page 77 for details)

SE1004100 - DuoFlex Receiver (see page 77 for details)

Cool white & warm white diodes side by side. The strip is marked at intervals where it can be cut.



From top to bottom: warm white LED, natural white LED and cool white LED.



DuoFlex dimensions:

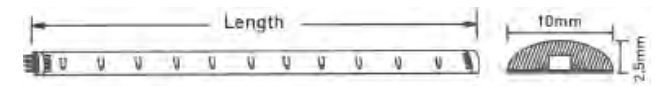

The Inline Switch - included in the SE10053D1 Starter Pack (not sold separately)

Cable/accessories

Driver Connection Lead - 2500mm - (SE10325) - £2.28
One driver lead is required for each run of the DuoFlex.

DuoFlex Inter-Connecting Lead - 500mm (SE10328) - £2.40
DuoFlex Corner Connection Lead - 50mm (SE10327) - £1.44

DuoFlex Remote Control

NEW

'control both LED colour and brightness'

- > The DuoFlex remote control allows you to choose from both cool white and warm white LED, or to create a natural white tone by mixing the two colours.
- > One remote can control multiple receivers, allowing you to control DuoFlex located in different areas of the kitchen.
- > Functions of the DuoFlex remote control:
 - Rotate the colour temperature wheel to select the desired colour temperature.
 - Decrease the brightness level of the DuoFlex strips (in 10% increments).
 - Increase the brightness level of the DuoFlex strips (in 10% increments).
 - On/off – switch the connected fittings on/off.
 - Memory function of the last setting before switched off.
 - Radio Signal - the maximum range of the remote control is 15m.



Code	Max Wattage	Product description	Driver	RRP
SE1003000	n/a	DuoFlex Remote Control	■	£23.28
SE1004100	22.5W per receiver	DuoFlex Receiver	■	£33.36

The SE40555 15W driver will run a maximum of 4m of the DuoFlex.
 The SE40556 30W driver will run a maximum of 6m of the DuoFlex.

The maximum length of the DuoFlex which can be run from one DuoFlex receiver is 6m.

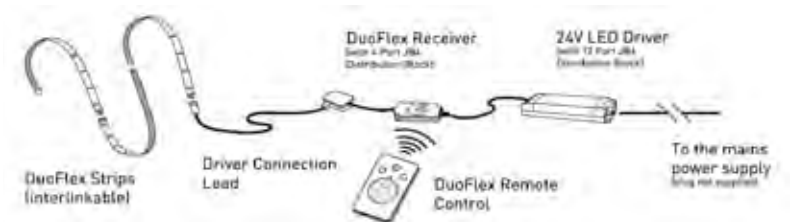
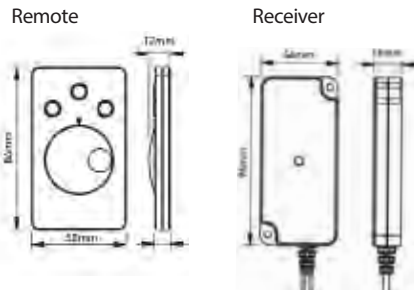
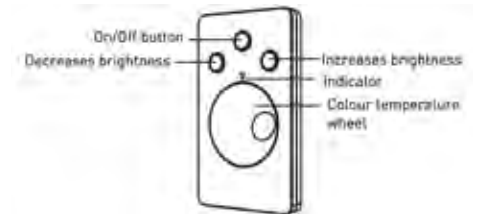

Flexible Strip Lighting >

Viva LED Flexible Strip

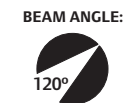
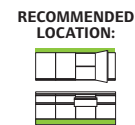

'can be used almost anywhere'

- > Self-adhesive 3M tape backing allows for quick and simple installation.
- > Male and female ends on the strip allow you to create the length required.
- > The strip can be cut to length, scissor marks on the product mark where suitable to cut.
- > Re-use a cut section of the strip ONCE using the mini-cut connector (SE10318MCC).
- > Extremely low energy consumption, only 5W per 2000mm.
- > Use this product for a variety of applications (on the plinth, above cabinets to up-light the ceiling, below the worktop on a handleless kitchen to name a few).
- > All you need to install is an adequate amount of flexible strips, driver connection lead(s) – one per run of strips and a LED driver.
- > Run a maximum length of 12m from one driver (based on using the 30W driver).



Code	Wattage	Length	LED No.	LED Colour	Lumens	Driver	RRP
SE10310CW	0.8W	300mm	12	Cool White (5000K)	36Lm	■	£11.88
SE10310WW	0.8W	300mm	12	Warm White (3200K)	36Lm	■	£11.76
SE10312CW	2.5W	1000mm	36	Cool White (5000K)	107.5Lm	■	£32.76
SE10312WW	2.5W	1000mm	36	Warm White (3200K)	107.5Lm	■	£32.76
SE10311CW	5W	2000mm	72	Cool White (5000K)	215Lm	■	£56.64
SE10311WW	5W	2000mm	72	Warm White (3200K)	215Lm	■	£56.64

Packs

SE10312CWK1	2.5W	1000mm	36	Cool White (5000K)	107.5Lm	included	£57.96
SE10312WWK1	2.5W	1000mm	36	Warm White (3200K)	107.5Lm	included	£57.96
SE10311CWK1	5W	2000mm	72	Cool White (5000K)	215Lm	included	£81.72
SE10311WWK1	5W	2000mm	72	Warm White (3200K)	215Lm	included	£81.72

2m Flexible LED Strip Light



SE10318MCC Cut Joining Connector

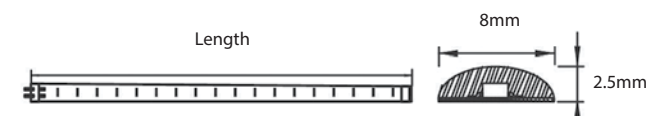

Cable

LED Flexible Strip Driver Connection Lead – 2500mm - (SE10314) - £1.92
Required to run Flexible LED Strip Light

LED Flexible Strip Corner Connection Lead – 50mm (SE10316) - £0.84
LED Flexible Strip Inter-Connecting Lead – 1500mm (SE10317) - £1.56
LED Flexible Strip Cut Joining Connector (SE10318MCC) - £0.60

Accessories

Under cabinet IR swipe on/off sensor (SE40516) Page 105
IR swipe on/off sensor switch (SE40517) Page 106
IR on/off sensor switch & dimmer (SE40520) Page 105
LED Dimming Remote Control (SE40581) Page 108
Dimming remote control & receiver (SE40670 & SE40682/4) Page 109

Flexible Strip Lighting >

Vega

HD LED Flexible Strip

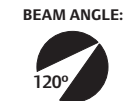
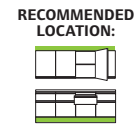
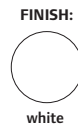

'3.5 times brighter than the standard'

- > Self-adhesive 3M tape backing allows for quick and simple installation.
- > High light output, 3.5 times brighter than the standard flexible LED strip light.
- > Male and female ends on the strip allow you to create the length required.
- > The strip can be cut to length, scissor marks on the product mark where suitable to cut.
- > Re-use a cut section of the strip ONCE using the mini-cut connector (SE90317HD).
- > Use this product for a variety of applications (on the plinth, above cabinets to up-light the ceiling, below the worktop on a handleless kitchen to name a few).
- > All you need to install is an adequate amount of flexible strips, driver connection lead(s) – one per run of strips and a LED driver.
- > Run a maximum length of 6.66m from one driver (based on the 50W driver).



Code	Wattage	Length	LED's	LED Colour	Lumens	Driver	RRP
SE90310HDCW	2.5W	330mm	12	Cool White (5000K)	168Lm	■	£22.68
SE90310HDWW	2.5W	330mm	12	Warm White (3000K)	155Lm	■	£22.68
SE90311HDCW	7.5W	1000mm	36	Cool White (5000K)	503Lm	■	£63.48
SE90311HDWW	7.5W	1000mm	36	Warm White (3000K)	465Lm	■	£63.48
SE90312HDCW	15W	2000mm	72	Cool White (5000K)	1005Lm	■	£127.20
SE90312HDWW	15W	2000mm	72	Warm White (3000K)	930Lm	■	£127.20

Packs

SE90311HDCWK1	7.5W	1000mm	36	Cool White (5000K)	503Lm	included	£79.32
SE90311HDWWK1	7.5W	1000mm	36	Warm White (3000K)	465Lm	included	£79.32
SE90312HDCWK1	15W	2000mm	72	Cool White (5000K)	1005Lm	included	£150.00
SE90312HDWWK1	15W	2000mm	72	Warm White (3000K)	930Lm	included	£150.84

HD LED flexible strip light

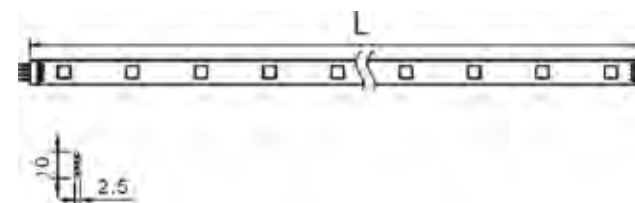

Cable

HD LED Flexible Strip Driver Connection Lead – 2500mm - (SE90314HD) - £2.64
Required to run the HD LED Flexible Strip

HD LED Flexible Strip Inter-Connecting Lead – 500mm (SE90315HD) - £3.12
HD LED Flexible Strip Corner Connection Lead – 50mm (SE90316HD) - £2.52
HD/RGB LED Flexible Strip Cut Joining Connector (SE90317HD) - £0.96

Accessories

Under cabinet IR swipe on/off sensor (SE40516) Page 105
IR swipe on/off sensor switch (SE40517) Page 106
IR on/off sensor switch & dimmer (SE40520) Page 105
LED Dimming Remote Control (SE40580) Page 108
Dimming remote control & receiver (SE40670 & SE40682/4) Page 109

RGB Colour Changing Flexible Strip

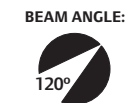
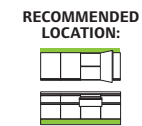
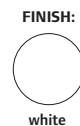

'7 colours, 3 effects'

- > Self-adhesive 3M tape backing allows for quick and simple installation.
- > 7 preset colours of the RGB (cool white, violet, yellow, cyan, green, red and blue).
- > The perfect product to create mood lighting, either set to one of the 7 colours, or select the slow or rapid colour change option.
- > 2000mm length now available.
- > Male and female ends on the strip allow you to create the length required.
- > The strip can be cut to length, scissor marks on the product mark where suitable to cut.
- > Re-use a cut section of the strip ONCE using the mini-cut connector (SE90317HD).
- > Use the SE40570/1 remote control to create the effect or choose the colour that is perfect for you at the touch of a dial.
- > All you need to install is an adequate amount of flexible strips, driver connection lead(s) – one per run of strips and a RGB control.
- > Run a maximum length of 6m from one driver.

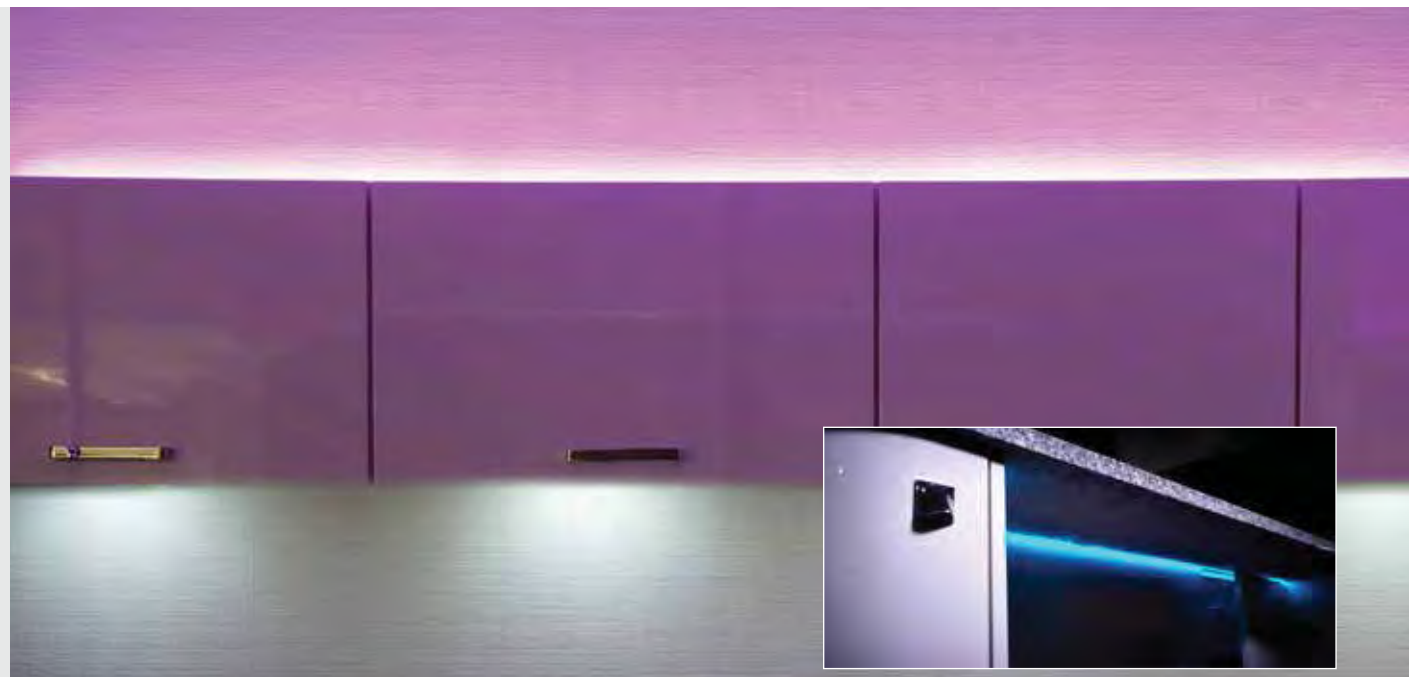

Code	Wattage	Length	LED Colour	Driver	RRP
SE10320	1.8W	300mm	7 Pre-set Colours	■	£20.64
SE10322	10W	2000mm	7 Pre-set Colours	■	£101.64

Pack

Code	Wattage	Length	Cable	Other items included	RRP
SE10160R1	10W	2000mm	2 x 2.5m	1 x SE40571, 1 x SE90317HD	£206.52
SE10320K4	7.2W	1200mm	1 x 2.5m	1 x SE40522	£123.00

LED RGB Colour Changing Flexible Strip Light

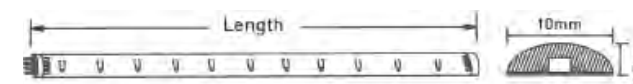

Cable

- LED RGB Flexible Strip Driver Connection Lead - 2500mm (SE10325) - £2.28
Required to run the RGB LED flexible Strip
- LED RGB Flexible Strip Corner Connection Lead - 50mm (SE10327) - £1.44
- LED RGB Flexible Strip Inter-Connecting Lead - 500mm (SE10328) - £2.40
- RGB/HD LED Flexible Strip Cut Joining Connector (SE90317HD) - £0.96

Accessories

- 15W RGB Push Button Driver with 4 RGB Ports (SE40522)
- 15W Driver with 4 RGB Port, Remote, Receiver and Controller (SE40570)
- 30W Driver with 8 RGB Port, Remote, Receiver and Controller (SE40571)

RGB Remote Control

'create coloured effects and moods'

- > Create the effect or choose the colour that is perfect for you at the touch of a dial.
- > Functions of the RGB remote control:
 - Single colour mode – select one colour by rotating the wheel
 - Gradual colour change – light colour gradually changes
 - Colour change speed – change the speed at which the colours change
 - Flashing colour change mode – light colour rapidly changes
 - Brightness level – change through the 5 brightness levels of the RGB
 - On/off – switch the connected fittings on/off
- > Memory function of the performance before last switched off.
- > Radio Signal - Maximum range of controller is 10m.



Code	Max Wattage	Use with	Driver	RRP
SE40570	15W	12V RGB products only (page 80)	■	£90.12
SE40571	30W	12V RGB products only (page 80)	■	£101.40



RGB Remote Control

Single colour; gradual colour change; rapid colour change; change colour change speed; dim; on/off

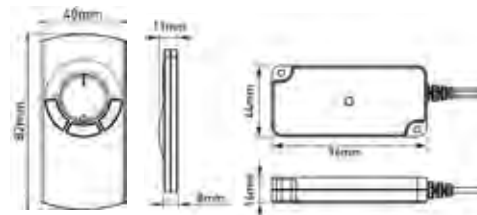



Plinth Lighting >



Plinth Lighting >

Puro

4 x LED Plinth Light Kit

FINISH:
transparent PC

LED COLOUR:
cool warm

LAMP LIFE:
25 years

RECOMMENDED LOCATION:

CABLE LENGTH:
2 metres

BEAM ANGLE:
90°

'compact & simple, yet very effective'

- > 4 fittings supplied in the pack along with the LED driver ready to connect directly to the mains supply.
- > Each fitting runs at only 0.48W making them extremely energy efficient.
- > IP44 Rated (protected against splashing water).
- > The fitting itself is completely transparent – the perfect invisible dot plinth lighting solution.
- > 15mm fittings – very discreet.
- > The fittings daisy chain together for simple installation.
- > Suited to both contemporary and modern kitchens as you can choose from cool white and warm white LED.
- > 3W driver in each pack, run a maximum of 6 fittings from one driver.



Code	Wattage	LED Colour	Light Qty	Lumens	Driver	RRP
SE10130CW	1.92W	Cool White (6500K)	4	20Lm	included	£28.80
SE10131CW	1.92W	Cool White (6500K)	4 (add ons)	20Lm	N/A	£21.00
SE10130WW	1.92W	Warm White (3500K)	4	19.2Lm	included	£28.80

2m of cable per fitting and on the LED driver

Plinth Light Kit

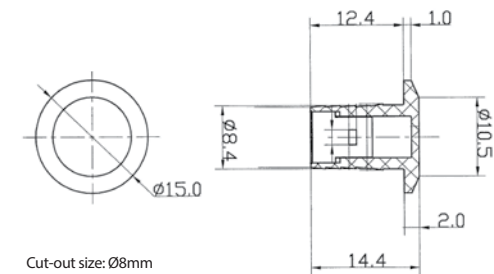



Plinth Lighting >

Luce SLS LED Plinth Light Kit

FINISH:

stainless steel

LED
COLOUR:

cool warm

LAMP LIFE:

25
years

RECOMMENDED
LOCATION:

CABLE LENGTH:

1.5 metres

BEAM ANGLE:

130°

'invisible LED's'

- > The stainless steel surround provides a high quality finish.
- > The fitting has 3 concealed LED's integrated into the top edge to create a diffused light effect with no visible LED points.
- > 4 fittings supplied in the pack along with the LED driver, ready to connect directly to the mains supply.
- > Energy efficient product, each fitting runs at only 0.18W.
- > Light sits flush to the plinth for a sleek and stylish look.
- > Fittings daisy chain together for simple installation.
- > Suited to both contemporary and modern kitchens as you can choose from both cool & warm white LED.
- > The driver in this pack has a maximum allowance of 4W .
A maximum of 22 fittings can be run from the one driver.



Code	Wattage	LED Colour	Light Qty	Driver	RRP
06.1110.0110	0.72W	Cool White (3950K)	4	included	£40.68
06.1110.0120	0.72W	Warm White (3050K)	4	included	£40.68

SLS
surface light source

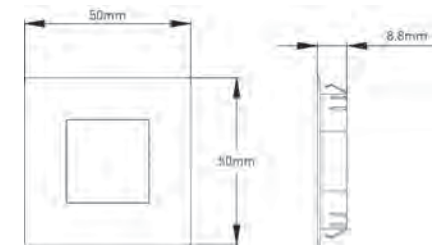

Cut-out size: Ø44mm

Plinth Lighting >

Fyra LED Plinth Light Kit

FINISH:



satin chrome

LED COLOUR:



cool warm

LAMP LIFE:



years

RECOMMENDED LOCATION:



BEAM ANGLE:



120°

'set the mood'

- > Pack includes; 4 x fittings and 1 x plugged LED driver
- > Fittings daisy chain together for simple installation.
- > LED driver included in the pack - ready to connect straight to the mains supply.
- > Both cool white and warm white LED available to suit both contemporary and traditional kitchens.
- > IP44 Rated fittings (protected against splashing water).
- > Only 0.5W per fitting for minimal energy usage.
- > No heat is emitted from the LED's – cool to the touch.
- > Simple to install, press fit with self-adhesive backing on each fitting for additional support.
- > The driver in this pack has a maximum allowance of 4W .
A maximum of 8 fittings can be run from the one driver.

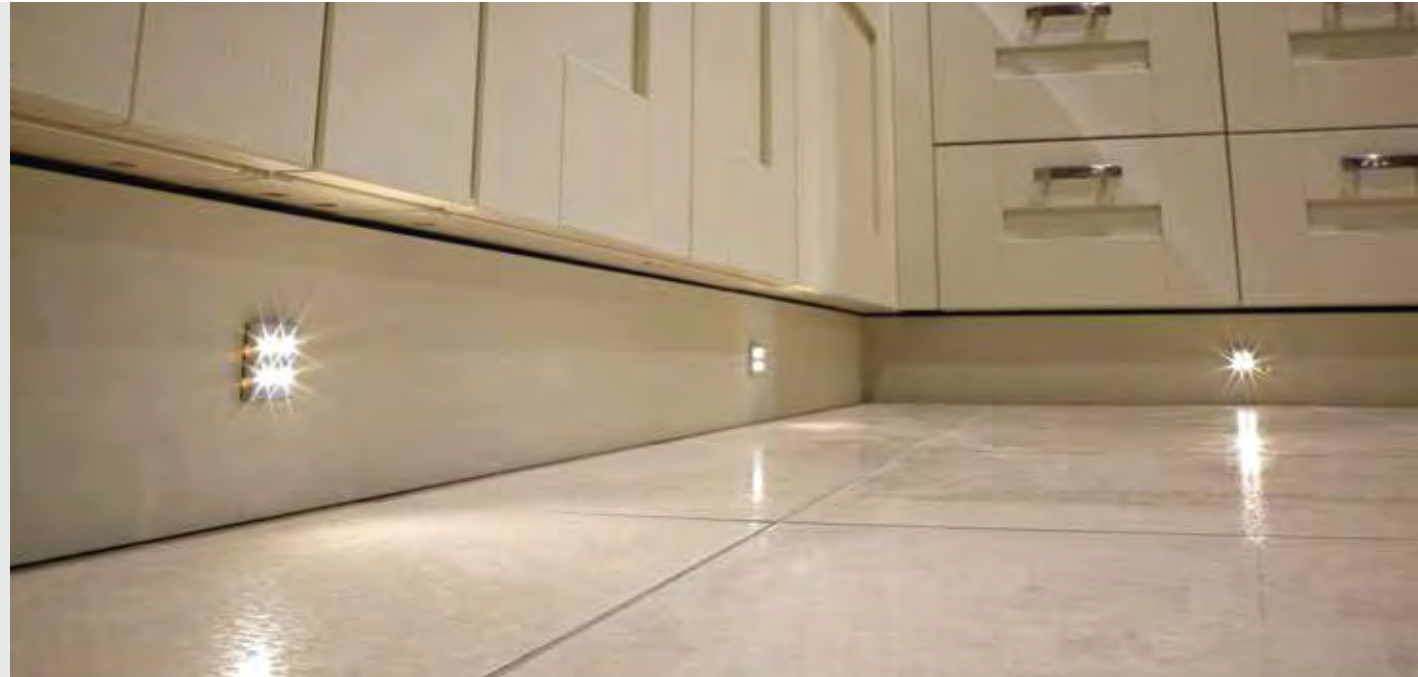

Code	Wattage	LED Colour	Qty	Lumens	Cable	Driver	RRP
SE10133CW	2W	Cool White (6000K)	4	16Lm	1.9m	included	£33.24
SE10133WW	2W	Warm White (3000K)	4	15Lm	1.9m	included	£33.24

Plinth Light Kit

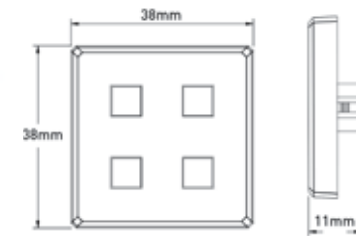

Cut-out size: Ø10mm

Plinth Lighting >

Nimbus LED Plinth Light Kit

FINISH:



stainless steel

LED COLOUR:



cool

LAMP LIFE:



years

RECOMMENDED
LOCATION:



BEAM ANGLE:



30°

'mood lighting for the kitchen or bathroom'

- > IP68 rated fittings suitable for use on kitchens plinths or in bathrooms.
- > All components required are included in the pack (5 or 10 fittings, junction box and LED driver).
- > 5 metres of cable on each individual fitting.
- > Quality stainless steel fitting.
- > 3 LED diodes integrated within each fitting.
- > Cool white LED, an ideal plinth lighting option for the contemporary kitchen design.
- > Low energy consumption, each fitting runs at only 0.4W.

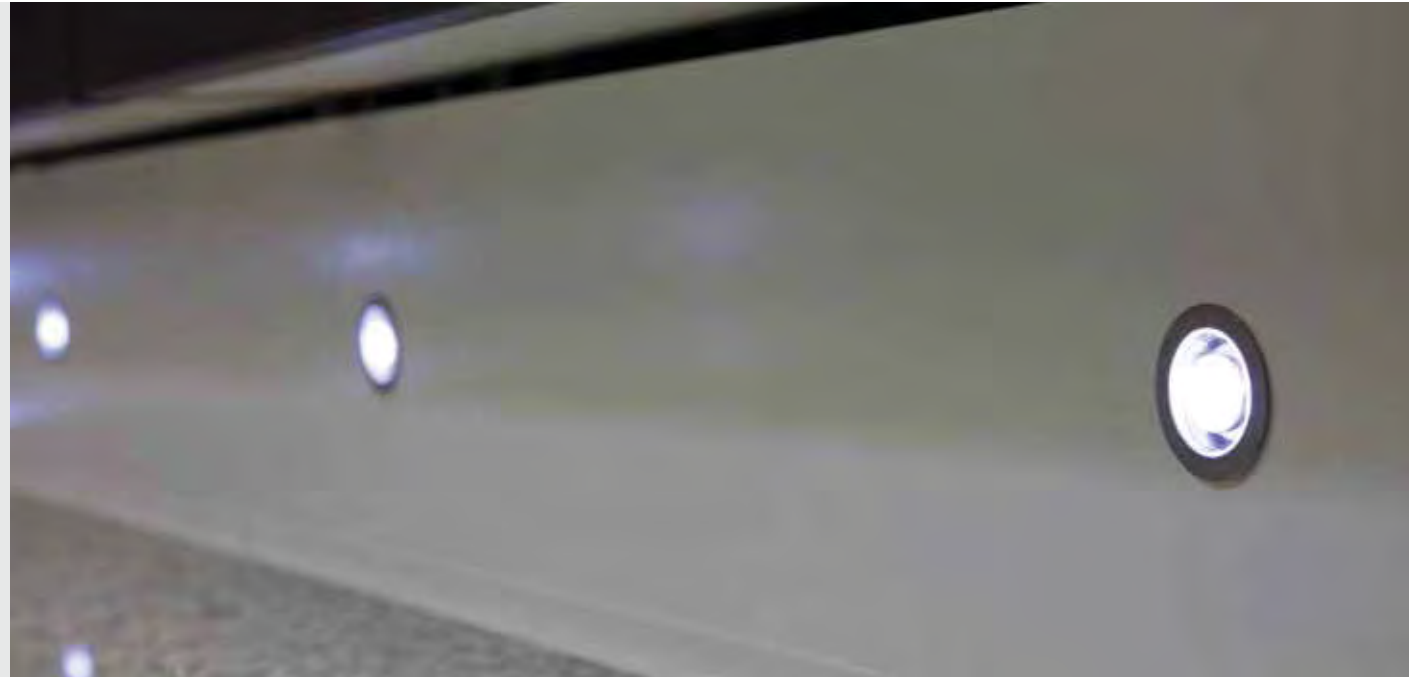

Code	Wattage	LED Colour	Pack Qty	Cable	Driver	RRP
SE10194CW	2W	Cool White (5300K)	5	5m PF*	included	£65.40
SE10195CW	4W	Cool White (5300K)	10	5m PF*	included	£95.40

PF* - per fitting

Plinth Light Kit

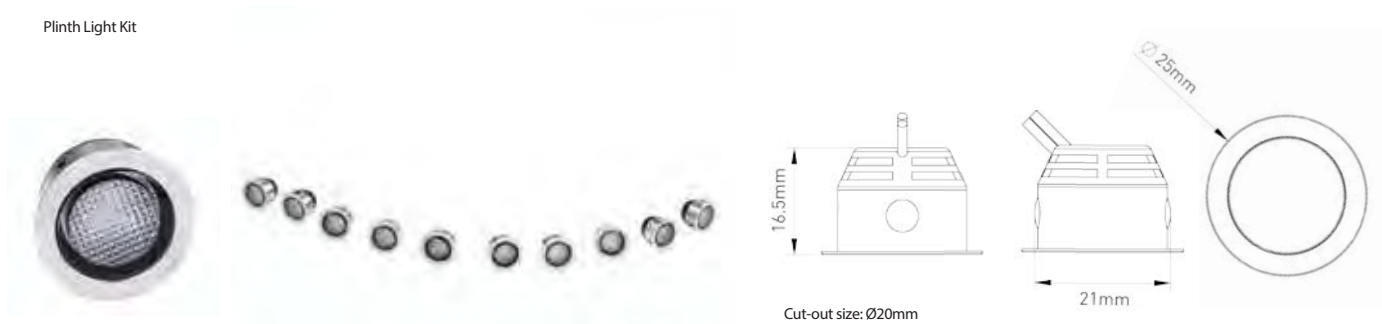

Plinth Lighting >

Specto LED Plinth Light Kit

FINISH:

chrome

LED
COLOUR:

cool warm

LAMP LIFE:

25
years

RECOMMENDED
LOCATION:

CABLE LENGTH:

1.5 metres

BEAM ANGLE:

30°

'stylish, discreet fitting, stunning effect'

- > 4 fittings supplied in the pack along with the LED driver.
- > Each fitting runs at only 0.16W making this the most energy efficient plinth light kit.
- > IP44 Rated (protected against splashing water).
 - ideal for both kitchen plinth and use in bathrooms
- > 15mm fittings – very discreet.
- > Chrome surround with an individual LED per fitting.
- > The fittings daisy chain together for simple installation.
- > Suited to both contemporary and modern kitchens as you can choose from cool white and warm white LED.
- > 6W driver included in the pack meaning a maximum of 37 fittings could be run from the one driver (fittings not sold individually).



Code	Wattage	LED Colour	Pack Qty	Lumens	Driver	RRP
SE10139CW	0.64W	Cool White (5500K)	4	9Lm	included	£32.40
SE10139WW	0.64W	Warm White (3000K)	4	7.08Lm	included	£32.40

Above values are per kit

Plinth Light Kit

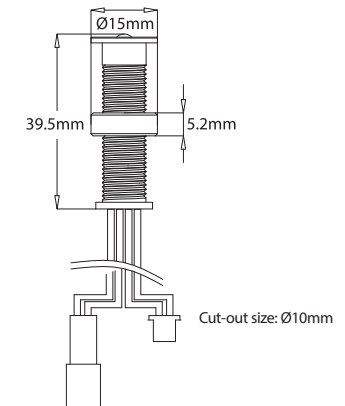

Plinth Lighting >

Sirius LED Square Plinth Light Kit

FINISH:

satin chrome

LED COLOUR:

cool

LAMP LIFE:

years

RECOMMENDED
LOCATION:

CABLE LENGTH:

1.5 metres

BEAM ANGLE:

110°

'the super bright'

- > High definition LED fitting, the brightest of the Sensio range of plinth lighting.
- > Contemporary look, with satin chrome finish and cool white LED.
- > Each fitting contains one 1W HD LED.
- > The high light output of these fittings makes them ideal mood lighting for a room when all other lighting is switched off.
- > Slim profile design.
- > A maximum of 6 fittings can be run from the driver included in the kit.



Code	Wattage	LED Colour	Qty	Lumens	Driver	RRP
SE9040HDCW	1W	Cool White (6650K)	1	28Lm	add on fitting	£11.76
SE9040HDCWK4	4W	Cool White (6650K)	4	28Lm	included	£60.84

LED Square Plinth Lights

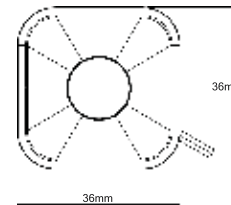

Cut-out size: Ø25mm

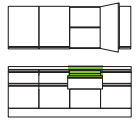

Drawer Lighting >



Verso LED Drawer Light

FINISH:



aluminium

LED COLOUR:



cool

COLOUR TEMPERATURE:



LAMP LIFE:



years

RECOMMENDED LOCATION:



CABLE LENGTH:



2.5 metres

BEAM ANGLE:



90°

'the ultimate functional light'

- > Various lengths available to suit standard drawer carcasses.
- > Cool white high definition LED to provide optimum light output.
- > IR sensor integrated on the front edge of the fitting, as soon as the drawer is opened the light will illuminate. Once the drawer is closed the fitting will switch off immediately to ensure no energy wastage.
- > The ideal solution to illuminate pan drawers.
- > Low wattage, meaning a full drawer stack can be illuminated using only one LED driver.
- > Brackets and cable tidy supplied.



Code	Wattage	Length	LEDs	Lumens	Driver	RRP
SE7300HDCW	2.6W	462mm	33	140Lm	■	£36.12
SE7305HDCW	3.3W	562mm	42	188Lm	■	£42.24
SE7310HDCW	4.5W	762mm	60	248Lm	■	£48.24
SE7315HDCW	5.4W	862mm	72	302Lm	■	£54.24
SE7320HDCW	6W	962mm	81	312Lm	■	£62.04
SE7325HDCW	7.3W	1162mm	99	387Lm	■	£68.16

HD LED Drawer Light

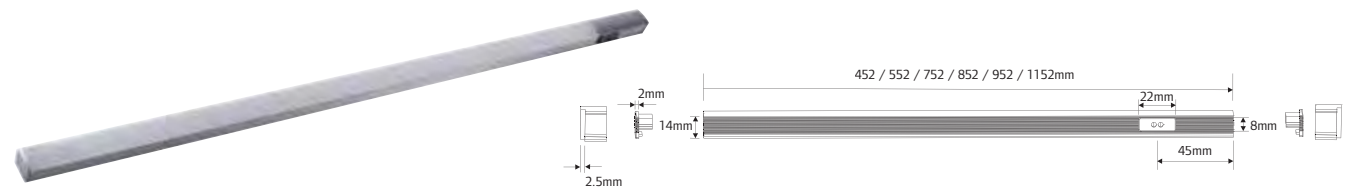

Accessories

2.5m extension cable (SE9009) - £2.04

Drawer Lighting >

Vista LED Battery Drawer Light

FINISH:



aluminium

LED COLOUR:



cool

COLOUR TEMPERATURE:



BATTERY OPERATED:



LAMP LIFE:



years

RECOMMENDED LOCATION:



BEAM ANGLE:



'no wiring - anyone can install'

- > No wiring necessary so anyone can install this fitting.
- > Requires 4 x AAA batteries to run (not included).
- > IR Sensor in-built (located in the centre of the fitting).
- > Two functions of this fitting:
 - Use as a drawer/in-cabinet light (the light switches on with the opening of a drawer/door).
 - Use as an under unit light (the light switches on/off when a hand passes the sensor).
- > When used for 3 minutes per day the batteries in the fitting will last approximately 1.5 years.
- > 5cm detection range of the IR Sensor.
- > Screws and adhesive pad included to install.



Code	Wattage	Cable	Power Source	RRP
SE9030HD	0.3W	n/a	4 x AAA Batteries	£26.16

HD LED Battery Operated Drawer Light

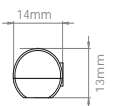

Ideal

Fit in the drawer where the torches and batteries are kept in case of a power cut.

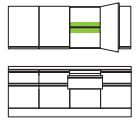

Shelf Lighting >



Shelf Lighting >

Edge LED Glass Clip Light

FINISH:



aluminium

LED COLOUR:



cool

COLOUR
TEMPERATURE:



LAMP LIFE:



years

RECOMMENDED
LOCATION:



CABLE LENGTH:



1 metre

BEAM ANGLE:



10°

'glass shelves, they're a feature, light them'

- > Cuttable. Buy the 450mm LED glass clip light and cut to the length you require. Use two lengths side by side for longer units.
- > Fits a 4-8mm pane of glass.
- > Use on glass shelves inside glass fronted cabinets to introduce soft, ambient mood lighting.
- > The lights shines out towards the front edge of the glass.
- > Extremely low wattage, meaning minimal energy consumption.
- > 450mm length as standard, cut to the length that you require.
- > Simple to install, clips onto the back of a glass pane and connects up to the suitable driver.
- > A relatively low cost item which creates a stunning effect.



Code	Wattage	Length	LED's	Lumens	Driver	RRP
SE9063HDCW	1.5W	450mm	21	50Lm	■	£10.80

HD LED Glass Clip Light

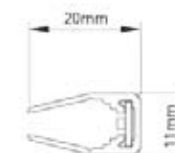

450mm

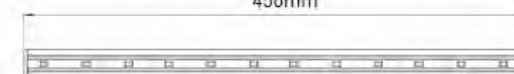

Accessories

- 2.5m extension cable (SE9009) - £2.04
- LED Dimming Remote Control (SE40581) Page 108
- Dimming remote control & receiver (SE40670 & SE40682/4) Page 109

Shelf Lighting >

Arc LED Glass Box Shelf

FINISH:



aluminium

LED COLOUR:



cool

COLOUR TEMPERATURE:



LAMP LIFE:



years

RECOMMENDED LOCATION:



CABLE LENGTH:



1.5 metres

'updated version of an old favourite'

- > Fitting has an aluminium frame with panes of glass on both the top and bottom.
- > High output, cool white LED strip integrated.
- > On/off switch integrated (located on the underside of the shelf – to the right hand side when fit).
- > LED driver built-in so no need to purchase and fit a separate driver.
- > Long lifespan of the LED strip integrated so there is no need for replacement lamps.
- > The maximum weight load of the shelf is 5kg.
- > Slimline design, depth of only 50mm.



Code	Wattage	Length	LEDs	Lumens	Connection	RRP
07.1120.0610	5.8W	450mm	24	264Lm	240V	£82.80
07.1121.0610	7.9W	600mm	33	363Lm	240V	£86.76
07.1122.0610	12W	900mm	51	1122Lm	240V	£109.92

Illuminated LED Glass Box Shelf

SLS
surface light source

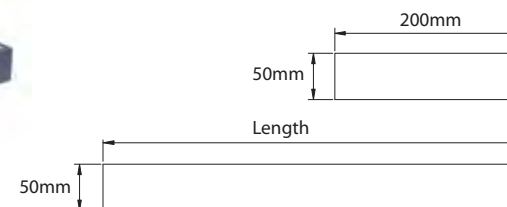

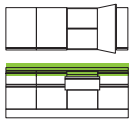

Integrated Solutions >



Linia

Recessed Aluminium Profile

FINISH:

 aluminium

RECOMMENDED
 LOCATION:

'flush fit for a minimalist look'

- > Perfect for use under kitchen cabinets or inside larders.
- > The ultimate discreet lighting solution.
- > Create the perfect task lighting or convenience lighting by selecting the HD LED flexible strip light.
- > Use with one of our in cabinet sensor switches (pages 105 & 107) when using inside a larder or cabinet so the light comes on as the door opens and switches off as the door is closed.
- > The profile is extremely slim to create the ultimate discreet lighting solution.
- > Aluminium profile with a frosted cover.
- > A versatile solution as both the profile and flexible strip can be cut to length
- > Butt lengths together for longer runs.



Code	Length	LED Strip	Cable	Driver	RRP
10.1008.0600	1m	Profile only	N/A	N/A	£11.88
10.1012.0600	2m	Profile only	N/A	N/A	£22.92

Flexible Strip Lighting sold separately - see pages 76-80 for options.



Recessed Aluminium Profile



End caps and mounting brackets included

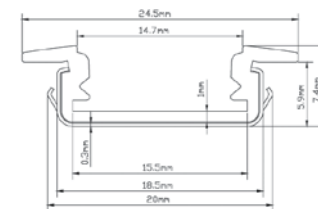

Cut-out
 width: 18.5 - 19mm
 Depth: 6 - 6.2mm

End Caps

2 x End caps for Recessed Profile (10.1017.0602) - £1.08
 2 x Mounting Brackets for Recessed Profile (10.1019.0602) - £1.08



Ripple Recessed Angled Profile

FINISH:
aluminium

RECOMMENDED
LOCATION:

'optimum illumination of the worktop'

- > Select the option with the HD LED Flexible strip light for under cabinet task lighting.
- > Options available with the RGB and Flexible Strip Light to create mood lighting.
- > The profile is extremely slim to create the ultimate discreet lighting solution.
- > Angled fitting for optimum illumination of the worksurface.
- > Aluminium profile with a frosted cover.
- > The profile protects the flexible strip light, protecting from moisture and dust and ultimately giving a more professional finish.
- > A versatile solution as both the profile and flexible strip can be cut to length.
- > Butt lengths together for longer runs.



Code	Length	LED Strip	Cable	Driver	RRP
10.1020.0600	1m	Profile only	N/A	N/A	£10.92
10.1024.0600	2m	Profile only	N/A	N/A	£21.12

Flexible Strip Lighting sold seperately - see pages 76-80 for options.



Angled Aluminium Profile

End caps included

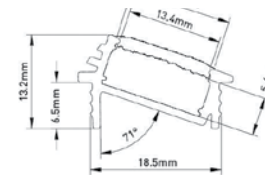

Cut-out
width: 18 - 18.2mm
Depth: 6.7 - 7mm

End Caps

2 x End caps for Angled Aluminium Profile (10.1029.0602) - £1.08



Continuum Profile

FINISH:
aluminium

RECOMMENDED LOCATION:

'diffused light for a professional finish'

- > Integrated lighting, designed to be seen.
- > Create stunning mood lighting with this product. The profile diffuses the LED's for the ultimate professional finish.
- > A key design consideration would be to fit this product beneath the worktop or to router into the worktop itself.
- > Another consideration would be to face fix the profile at plinth height.
- > Choose from the DuoFlex, HD, Standard or RGB flexible strip light to create the desired effect for your kitchen design.
- > Butt lengths together for longer runs.
- > Versatile product as the profile and the flexible strip can be cut to length.



Code	Length	LED Strip	Cable	Driver	RRP
10.1032.0600	1m	Profile only	N/A	N/A	£13.92
10.1036.0600	2m	Profile only	N/A	N/A	£27.12

Flexible Strip Lighting sold separately - see pages 76-80 for options.



End Caps

2 x End caps for Continuum Profile (10.1040.0602) - £1.08



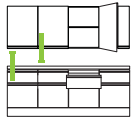

SensioPod >



SensioPod >

SensioPod Pull up Socket

FINISH:
aluminium

RECOMMENDED
LOCATIONS:
> worktop
> centre islands
> under cabinet (pull down)

CABLE LENGTH:
2.5 metres

'great for usb charging'

- > Two USB ports integrated to charge the latest USB devices (maximum allowance 1300mA).
- > Slim profile design with aluminium casing.
- > This product has a specially designed chrome handle which makes it simple to pull the fitting up.
- > IP54 rated so can be fitted around sinks.
- > Quick release catch to guarantee the unit will always close securely.
- > Neon green control switch provides a simple means of checking appliances have been turned off when not in use to save on energy bills.
- > Visible plugs and unsightly cables will no longer be seen as the SensioPod can be retracted fully whilst products are still plugged in.
- > No need to access the fuse under the plinth should it need changing, as the fuse is built into the model below the on/off switch.



Code	Finish	Connection	Sockets	RRP
SE80050AL	Aluminium Effect	13A plug included	3 x power & 2 x USB	£80.04

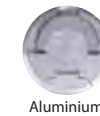
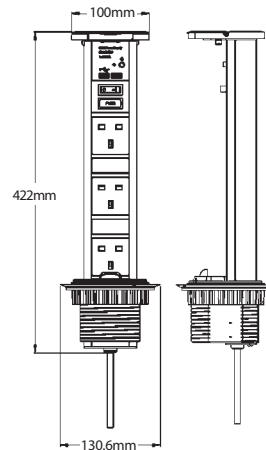
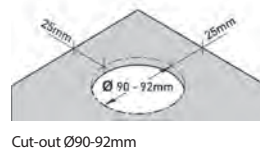

SensioPod >

SensioPod+ Pull up Socket

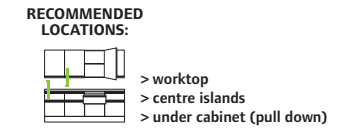
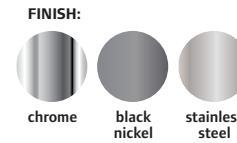

'slim profile, contemporary finishes'

- > Die cast metal top in a choice of three finishes, Chrome, Black Nickel and Stainless Steel.
- > Two USB ports integrated to charge the latest USB devices (maximum allowance 1300mA).
- > Aluminium casing and slim profile design, in-keeping with contemporary design trends.
- > IP54 rated so can be fitted around sinks.
- > Quick release catch to guarantee the unit will always close securely.
- > Neon green control switch provides a simple means of checking appliances have been turned off when not in use to save on energy bills.
- > Visible plugs and unsightly cables will no longer be seen as the SensioPod+ can be retracted fully whilst products are still plugged in.
- > No need to access the fuse under the plinth should it need changing, as the fuse is built into the model below the on/off switch.



SE80050CH

Code	Finish	Connection	Sockets	RRP
SE80050CH	Chrome	13A plug included	3 x power & 2 x USB	£124.56
SE80050GM	Black Nickel	13A plug included	3 x power & 2 x USB	£124.56
SE80050SS	Stainless Steel	13A plug included	3 x power & 2 x USB	£124.92

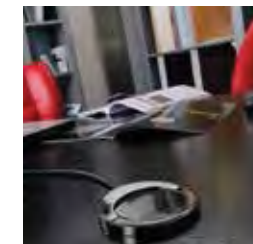
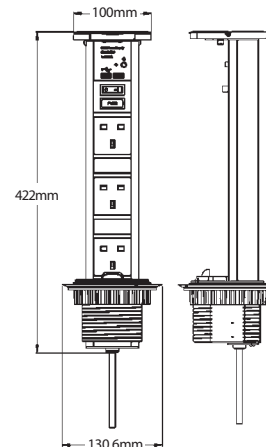
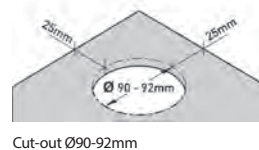

SE80050GM – Black Nickel

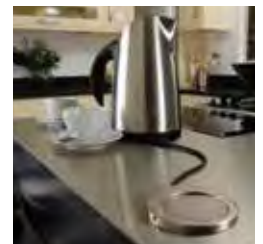

SE80050SS - Stainless Steel

SensioPod >

SensioPod Eco Pull up Socket

FINISH:
black

RECOMMENDED LOCATIONS:
> worktop
> centre islands
> under cabinet (pull down)

CABLE LENGTH:
2.5 metres

'great value convenience'

- > Economical SensioPod, this version has 3 power sockets only with a neon red on/off switch and quick release catch.
- > Aluminium casing and slim profile design, in-keeping with contemporary design trends.
- > IP54 rated so can be fitted around sinks.
- > Quick release catch to guarantee the unit will always close securely.
- > Neon red control switch provides a simple means of checking appliances have been turned off when not in use to save on energy bills.
- > Visible plugs and unsightly cables will no longer be seen as the SensioPod can be retracted fully whilst products are still plugged in.
- > No need to access the fuse under the plinth should it need changing, as the fuse is built into the model below the on/off switch.
- > Plastic top with a matte black finish. This product contains a specially designed chrome handle which makes it simple to pull the fitting up.



Code	Finish	Connection	Sockets	RRP
SE80050BK	Black	13A plug included	3 x power	£58.68

Dimensions	A	B	C	D	E
SE80050BK	Ø 130mm	14mm	414mm	Ø 100mm	324mm

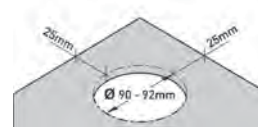

Cut-out Ø90-92mm

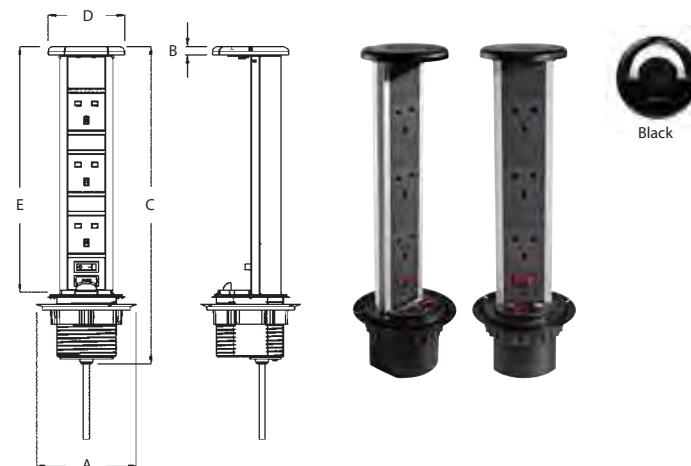

Fuse Cover



IP54 Rated

SensioPod >

SensioPod Data Pull up Socket

FINISH:
aluminium effect

RECOMMENDED LOCATIONS:
> worktop
> centre islands
> under cabinet (pull down)
> Home office
> Bedroom

CABLE LENGTH:
2.5 metres

'perfect for the home office'

- > Two RJ45 ports for PC/Laptop connectivity. Where wireless internet is not available, the SensioPod™ DATA allows laptops to be connected with the home's internet router or network.
- > Aluminium casing and slim profile design, in-keeping with contemporary design trends.
- > Specially designed chrome handle makes it simple to pull the fitting out.
- > IP54 rated so can be fitted around sinks.
- > Quick release catch to guarantee the unit will always close securely.
- > Neon green control switch provides a simple means of checking appliances have been turned off when not in use to save on energy bills.
- > Visible plugs and unsightly cables will no longer be seen as the SensioPod can be retracted fully whilst products are still plugged in.



Code	Finish	Connection	Sockets	RRP
SE80060AL	Aluminium Effect	13A plug included	3 x power & 2 x RJ45 ports	£90.12

Dimensions	A	B	C	D	E
SE80060AL	Ø 100mm	424mm	334mm	10mm	130.5mm

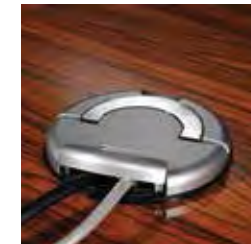
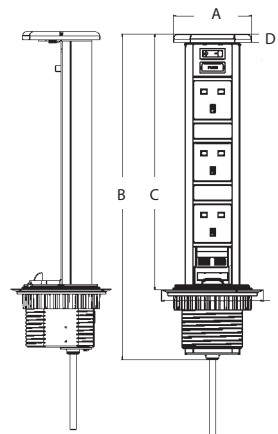
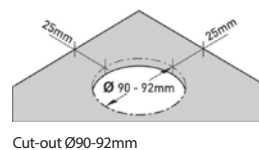

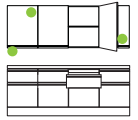

Sensors and Controllers >



Dual-function sensors

'activate lights with motion'

SE40516 Cabinet/Swipe Sensor Switch

- > Can be used with 12V & 24V products (without an integrated sensor).
- > Works as an on/off switch for these fittings.
- > Two functions of the sensor:
 - Mount inside a cabinet – open door to activate light.
 - Mount under cabinet – lights are activated when a hand passes before the sensor.
- > 5-10cm detection range, so unwanted detection is not a problem.
- > Can be surface mounted or recessed into a pelmet.
- > Plug and play, and no additional wiring is required by the electrician.



'3 functions, including dimming'

SE40520 Dimming Sensor Switch

- > Multi-functional product. The SE40520 has 3 functions, use as a dimmer, on/off switch or in-cabinet on/off switch for 12V & 24V LED products.
- > Attractive product, perfect for contemporary kitchens.
- > Use with any 12V or 24V Sensio product (without an integrated sensor).
- > Aluminium effect finish to match many of our best selling products.
- > plug and play, and no additional wiring is required by the electrician.



Monostable function
For inside cabinet mounting.

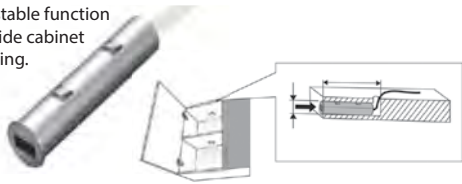

Bistable function
For under cabinet mounting.

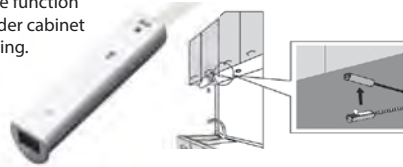

Code	Max Wattage	Use with:	Cut out:	Cable length:	Detection range	Driver	RRP
SE40516	15W (orange) or 30W (green)	12V or 24V products	14mm	1.5m with 6 port JB4 connector	5-10cm	orange green	£17.64

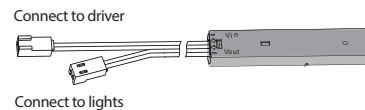
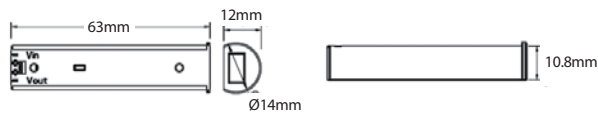

Operation

The SE40520 sensor has different functions.

in front of the sensor the dim the lights. The longer you hold the more the lights dim.

Under cabinet - The lights are activated by a hand swipe across the sensor and deactivated the same way. In this mode, hold your hand

In Cabinet - The lights are activated by the opening of a cabinet door and deactivated once the door closes.

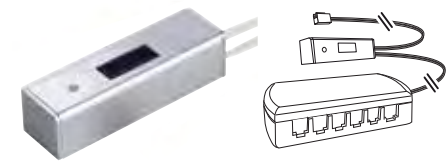

Code	Max Wattage	Use with:	Cable length:	Detection range	Driver	RRP
SE40520	15W (orange) or 30W (green)	12V or 24V products	2.5m with 6 port JB4 connector	5-10cm	orange green	£15.60

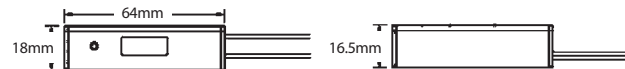

Under cabinet sensors

'activate lights with motion'

- SE40517 - 250W Infra-red Swipe Sensor Switch
- > Maximum detection range: 5-10cm, to ensure the sensor is not activated when not required. Swipe hand past the sensor to activate lights.
 - > Can be used with; 12V, 24V or 240V fittings.
 - > Suitable to use with the majority of Sensio fittings.
 - > The motion sensor detects body heat motion and automatically switches the lights on or off.
 - > High wattage of 250W means the sensor will run a large number fittings.



'activate lights with touch'

- SE7004AL - Quadra LED Touch
- > Sensor Switch > Can be used with all Sensio 12V LED products which do not have an integrated sensor.
 - > Attractive product, perfect for contemporary kitchens.
 - > The touch sensor will illuminate blue when it has power.
 - > Certain Quadra products are daisy chained, include the SE7004AL for synchronised switching.
 - > Small & discreet accessory.



Recess into the side panel of a kitchen cabinet. A hand swipe will switch all connected lighting on/off

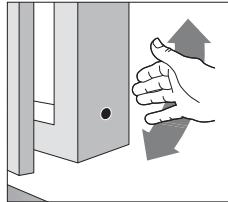

Code	Max Wattage	Use with:	Cut out:	Cable length:	Detection range	Driver	RRP
SE40517	250W	12V, 24V or 240V products	13mm	2m	5-10cm		£24.60

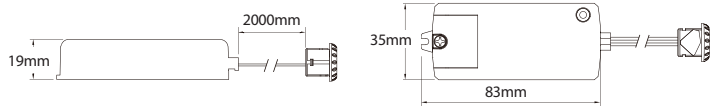

Configuration
Multiple Quadra units can be daisy chained together for synchronised switching.

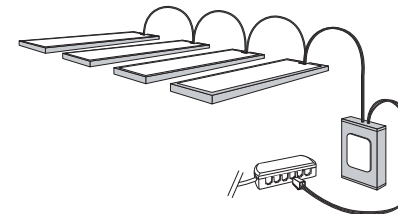

Code	Max Wattage	Use with:	Cable length:	Driver	RRP
SE7004AL	30W	12V Quadra range	2 x 1m cables		£13.32

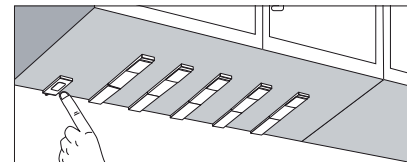

Operation
Once the unit has power the touch sensor will illuminate blue. To operate, simply touch the sensor to switch the light fitting on. To turn off repeat this process.

Note: This product is not to be used in a series in which a sensor is already incorporated into the Quadra fittings.

In cabinet sensors

'activate lights with motion'

SE40518 - 250W Cabinet Sensor Switch

- > Detection range of 5cm. Recess into internal shelves in wall units or wardrobes. When the door is opened all connected lighting will be switched on and switched off when the door closes.
- > Can be used with; 12V, 24V or 240V fittings which do not have an integrated switch or sensor.
- > High wattage of 250W means the sensor will run a large number fittings.
- > Can be used in kitchens or bedrooms.
- > Very discreet switching option, especially in darker furniture.
- > Can be used in kitchens or bedrooms.



'activate lights with motion'

SE2015000 - 250W Motion Sensor Switch

- > Suitable to be used with 12V or 24V products without an integrated sensor.
- > Works as an on/off switch for in-cabinet lights.
- > Mount at the back of a cabinet unit, as the detection range is 2.5m.
- > An attractive and effective lighting control option.
- > Small and discreet product.
- > White finish.
- > Can be used in kitchens or bedrooms.

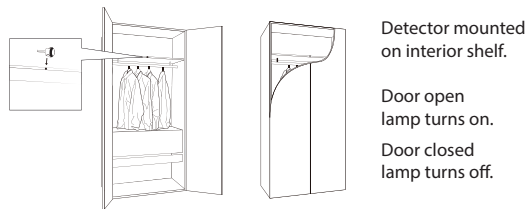

Code	Max Wattage	Use with:	Cut out:	Cable length:	Detection range	Driver	RRP
SE40518	250W	12V, 24V or 240V products	13mm	2m	5-10cm		£24.60

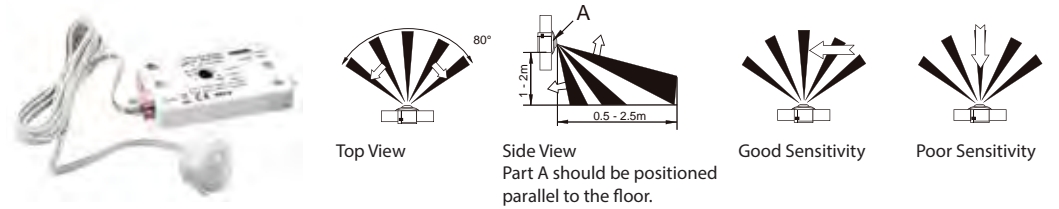
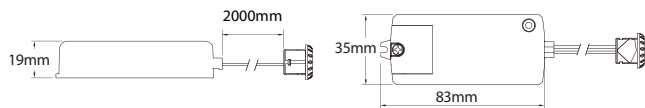

Code	Max Wattage	Use with:	Cable length:	Detection range	Driver	RRP
SE2015000	30W or 60W	12V or 24V products	1.5m with 6 port JB4 connector	0.5-2.5cm		£25.08

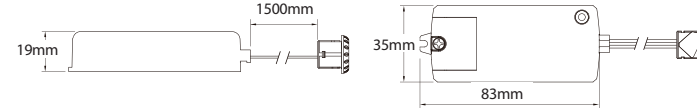

LED Dimming Remote Control >

'dimming and switching for all areas of lighting'

- > Create or choose the lighting level that is perfect for you at the touch of a button.
- > Multiple functions of the dimmer:
 - Dim to the lowest light level
 - Set to full brightness
 - Select the desired light level
 - On/off switching
- > Memory function of the performance before last switched off.
- > The pack includes; 1 x remote control, 1 x receiver, 1 x 15W driver and wall bracket
- > Maximum range of controller is 10m.



Code	Wattage	Use with	Driver	RRP
SE40580	15W	24V products without an integrated sensor	■	£88.44
SE40581	15W	12V products without an integrated sensor	■	£88.44



LED Dimming Remote Control

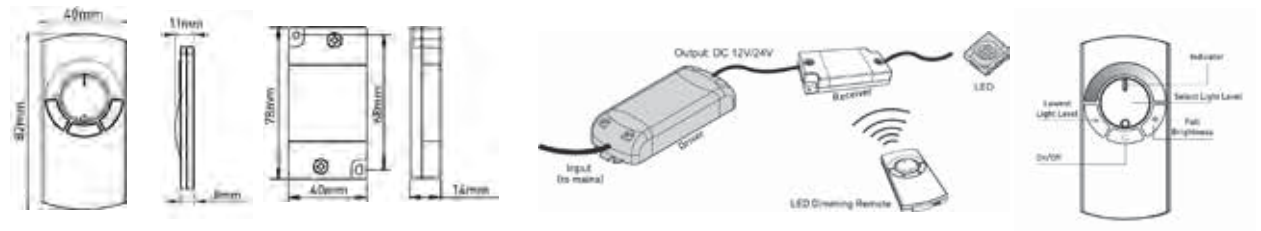

2/4 Channel LED Dimming Remote Controls >

'dimming and switching for all areas of lighting'

- > Create or choose the lighting level that is perfect for you at the touch of a button.
- > Multiple functions of the RF Dimmer:
 - Dim to the lowest light level
 - Set to full brightness
 - Select the desired light level
 - On/off switching
- > Memory function of the performance before last switched off.
- > One remote can control up to 8 receivers.
- > Each button on the remote control can be programmed to control one area of lighting (for example one button to control the under cabinet lighting and another to control the plinth lighting). Alternatively, control multiple areas of lighting from a single button.
- > Radio Signal - Maximum range of controller is 20m.

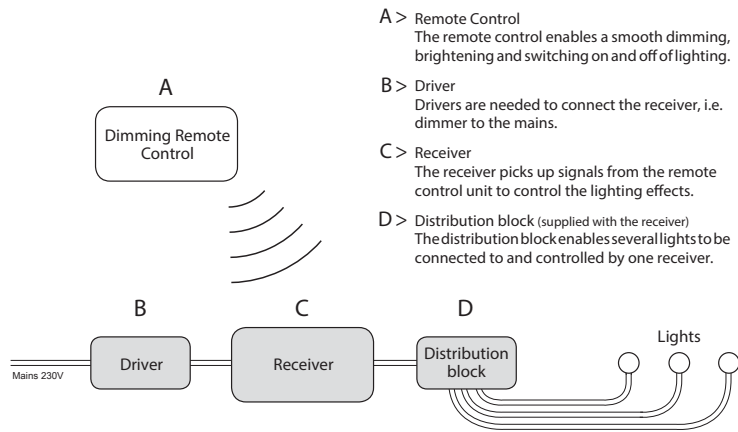

LED RF 30W/50W Wireless Dimming Receiver with 12 JB4 Distributor



Code	Max Wattage	Use with	Driver	RRP
SE40670	30W	12V products	Orange	£78.00
SE40675	50W	24V products	Green	£78.00



LED RF Remote Control 2 or 4 Channel Transmitter



Code	Buttons	Driver	RRP
SE40682	2	Orange Green	£48.60
SE40684	4	Orange Green	£117.00

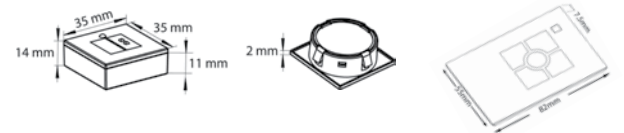



Open plan living means your lighting plan doesn't stop at the kitchen. Products such as the DuoFlex from the flexible strip lighting range can be carried through from the kitchen into the living room to highlight features such as a wall mounted TV and floating cabinet. (For help specifying the perfect lighting scheme speak to your Sensio representative).

Drivers

How to select the right driver for your lights:











1. All drivers in this brochure are colour coded. Refer to the product table to find the colour that is correct for your lights.
2. Each driver can run a number of lights. Simply divide the wattage of the driver by the wattage of a single light and this will tell you exactly how many lights can be run by the driver.

Example:

15W driver with 3W lights
 $15 \div 3 = 5$ lights

3. Some drivers are available in more than one rating e.g. 15W and 30W. Simply work out the best option dependent on the number of lights you have.

Note: Drivers have a limited number of ports where lights are connected. A driver with 12 ports is therefore limited to a maximum of 12 lights. See the table for the number of ports.

Code	Description	Colour Coding	RRP
SE40522	15W Driver with 4 RGB LED Port & Switch		£37.08
SE40625	6W Driver with 4 Port JB4 Distributor		£15.00
SE40525	15W Driver with 6 Port JB4 Distributor		£19.92
SE40526	30W Driver with 12 Port JB4 Distributor		£35.04
SE40553	6W Driver with 4 Port JB4 Distributor		£16.68
SE40554	6W Driver with 4 Port JB4 Distributor & 13A Plug		£18.48
SE40555	15W Driver with 6 Port JB4 Distributor		£20.28
SE40556	30W Driver with 12 Port JB4 Distributor		£33.12
SE40557	50W Driver with 12 Port JB4 Distributor		£52.32
SE40570	15W Driver with 4 RGB Port, Remote, Receiver & Controller		£90.12
SE40571	30W Driver with 8 RGB Port, Remote, Receiver & Controller		£101.40