

## PRODUCT CATALOGUE



*Selfa Grzejnictwo Elektryczne S.A. is the biggest Polish heating elements producer. Stabilized position (tradition since 1932) as well, as many years of experience and constantly growing sales, helped Selfa to obtain a titre of top quality heating elements production leader in Poland. Selfa has achieved its position through 2001 - 2007 long-term investment projects, such as: comprehensive modernization of the machinery park, production hall with social background, and the purchase of*

*new machinery and technological equipment. Selfa's essential purpose is to satisfy its Clients needs. Therefore Quality Management System in accordance with PN EN ISO 9001:2001 has been implemented (certified by VDE Institute). It helps to determine and ensure compliance of Selfa's products and services to customer requirements.*

*Realizing and understanding the need to turn into renewable energy in Poland and worldwide, We have decided to start photovoltaic modules production. Our new, photovoltaic plant is located in Stare Czarnowo, nearby Szczecin. In addition to photovoltaic modules production We offer turnkey PV solutions.*

*Selfa's employees are a team of professionals, who work in the slogan "We solve any hot problem". With years of experience, knowledge and interaction skills of our engineers, Selfa is able to create a product fully in accordance with the expectations of even the most demanding customers. Our work is not only a way to make money, but also the passion to solve most difficult and unusual tasks.*

*Stable prices as well, as wide range of products, its quality and company's policy – focused individually on each client – guarantees, that SELFA is an attractive and credible business partner.*

*We invite You for cooperation with us.*



President of the Board

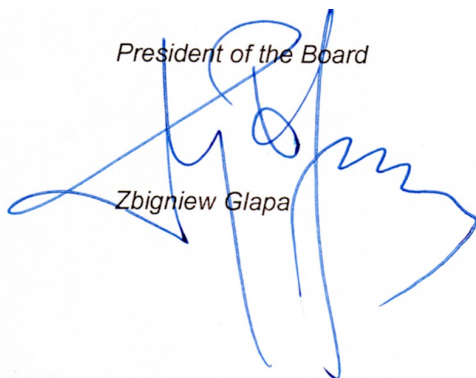

Zbigniew Glapa



# VDE Prüf- und Zertifizierungsinstitut

VDE VERBAND DER ELEKTROTECHNIK  
ELEKTRONIK INFORMATIONSTECHNIK e.V.

## CERTIFICATE

Registration Number: 1277400/QM/08.06

This is to certify that the company

**"SELFA"**  
**GRZEJNICTWO ELEKTRYCZNE SPOLKA AKCYJNA**

at the following location

**Ul. Bieszczadzka 14**  
**71-042 SZCZECIN**  
**POLAND**

has implemented and maintains a  
**Quality Management System** for the following scopes:

**Production, development, sales and consulting**  
**in the area electrical heating elements**

According to audit report 1277400-9100-0001/123534  
this QM System complies with the requirements of:

**DIN EN ISO 9001:2008**

This Certificate is valid until 2012-08-07

VDE Prüf- und Zertifizierungsinstitut GmbH  
VDE Testing and Certification Institute  
Certification

Date: 2009-12-08

63069 Offenbach, Merianstraße 28  
Telefon: +49 (0) 69 83 06-0, Telefax: +49 (0) 69 83 06-555  
E-Mail: [vde-institut@vde.com](mailto:vde-institut@vde.com), <http://www.vde-institut.com>



The VDE Testing and Certification Institute is accredited by DAR Accreditation  
Bodies according to DIN EN ISO/IEC 17020 and DIN EN ISO/IEC 17021 and notified in  
the EU under ID. No. 0366.

TGA-ZM-09-92-00

**VDE Prüf- und Zertifizierungsinstitut**

**ZEICHENGENEHMIGUNG  
MARKS APPROVAL**

SELFA GRZEJNICTWO ELEKTRYCZNE S.A.  
ul. Bieszczadzka 14  
71-042 SZCZECIN  
POLN

ist berechtigt, für ihr Produkt /  
is authorized to use for their product  
Rohteilkörper für ruhende Luft  
Tabular heating element for static air

die hier abgebildeten markenrechtlich geschützten Zeichen  
für die im Blatt 2 aufgeführten Typen zu benutzen /  
the legally protected marks as shown below for the types referred to on page 2 ff.

Geprüft und zertifiziert nach /  
Tested and certified according to

DN EN 60335-1 VDE 0750-21:07:02 DN 60335-2:02:01 A11 A14 A16 C10 + A2:2006  
DN EN 60335-1:02 VDE 0750-21:07:02:01 DN 60335-2:02:01

Altzeichen: 1277400-911-0003 / 103454

VDE Prüf- und Zertifizierungsinstitut GmbH  
Festlegung der Zertifizierung /  
Certification Authority / Certification  
Offenbach, 1917-03-07  
Internet: [www.vde.com](http://www.vde.com)  
VDE-Zentrum der Elektrotechnik

File n°: 05333 Blatt: 1  
Certificate No. Page  
Date of issue: 2009-12-08  
Date of expiry: 2012-08-07  
Autorisation: 2009-08-04

**2009 Gazele Biznesu**

Dziennik „Puls Biznesu” potwierdza przynależność firmy  
**Selfa Grzejnictwo Elektryczne S.A.**  
do elitarnego Klubu Gazel Biznesu  
grona najdynamiczniej rozwijających się firm

Arkadiusz Dawid, prezes zarządu  
Autor reklamowa  
**Puls Biznesu**

Julia Ziarno, redaktor naczelna  
Autor reklamowa  
**coface (POLSKO)**

**D&B**  
Decide with Confidence

Certyfikat  
**Przejrzysta Firma**

Nadawany za publikację sprawozdań finansowych  
i ich przekazanie ich Dun and Bradstreet Poland

**SELFA GRZEJNICTWO ELEKTRYCZNE S.A.**  
Numer DUNS: 367183923  
marzec 2009

## Table of contents

<b>TUBULAR HEATING ELEMENTS.....</b>	<b>2</b>
<i>Technology, structure and parameters.....</i>	2
<i>Heating element parameters.....</i>	2
<i>Selection criteria.....</i>	3
<i>Mounting components.....</i>	3
<i>Types of electrical connections.....</i>	5
<i>Heating elements catalogue.....</i>	6
LIQUIDS (WATER, OIL, OTHERS)	
Washing machine heaters.....	6
Heating elements for industrial washers.....	11
Heating elements for water heaters.....	11
Heating elements with controls for water heaters.....	19
Magnesium anodes.....	20
Heating elements for tea kettles and immersion heaters.....	21
Heating elements for water stills.....	21
Heating elements for oil heaters.....	22
AIR	
Heating elements to work in the air - various applications.....	23
Heating elements for electric cookers.....	24
Heating elements for electric cookers.....	26
Heating elements to work in the air with ventilation.....	26
Heating elements for catering and diners, for packaging machines, for saunas.....	27
OTHER	
Finned tubular heating elements.....	29
Radiator heaters for control cabinets.....	29
Heating elements for refrigeration.....	30
<b>CARTRIDGE HEATING ELEMENTS.....</b>	<b>31</b>
<i>Characteristics.....</i>	31
<i>Structure.....</i>	31
<i>Technical data.....</i>	31
<i>Application.....</i>	32
<i>Cartridge heater with embedded thermocouple – type GPT i GPFT.....</i>	32
<i>Electrical connection.....</i>	32
<i>Manufacture options.....</i>	33
<i>Selection and operation of cartridge heaters.....</i>	36
<i>Operating tips.....</i>	37
<b>BAND HEATERS.....</b>	<b>38</b>
<b>FLAT HEATING ELEMENTS.....</b>	<b>38</b>
<b>CERAMIC HEATING ELEMENTS.....</b>	<b>39</b>
<b>PLATING HEATERS.....</b>	<b>40</b>
<b>SPLIT HEATING ELEMENTS.....</b>	<b>41</b>
<b>COIL HEATING ELEMENTS.....</b>	<b>42</b>
<b>FULL COIL HEATING ELEMENTS.....</b>	<b>42</b>
<b>INFRARED RADIATORS.....</b>	<b>43</b>
<b>FLEXIBLE STRIP HEATERS.....</b>	<b>46</b>
<b>SILICON HEATING ELEMENTS.....</b>	<b>48</b>
<b>EXPLOSION-PROOF HEATING ELEMENTS.....</b>	<b>49</b>
<b>TEMPERATURE SENSORS.....</b>	<b>52</b>
<b>CONTROL EQUIPMENT.....</b>	<b>56</b>
<b>CERAMIC CONNECTION BLOCKS.....</b>	<b>60</b>
<b>CONDUCTORS IN HIGH-TEMPERATURE RESISTANT INSULATION.....</b>	<b>61</b>



## Tubular heating elements

### TECHNOLOGY, STRUCTURE AND PARAMETERS

#### Technology

Tubular heating elements are manufactured according to OAKLEY-KANTHAL technology; KANTHAL's and CSM's machines and equipment are used in the production process. The application of supreme quality materials and components manufactured by the industry leaders brings a number of benefits, such as:

- high and consistent quality of electrical parameters owing to the central location of the heating coil;
- long life and high operational reliability owing to the application of homogenous and highly compacted insulation made of top quality magnesium oxides, and use of top class resistance wires;
- high surface load and high maximum working temperature of the sheath surface owing to the application of the best grade pipes made of highly alloyed steels.

Our tubular heating elements meet the requirements of PN-EN 603351 and hold certificates for the "VDE" mark.

#### Structure of the tubular heating element

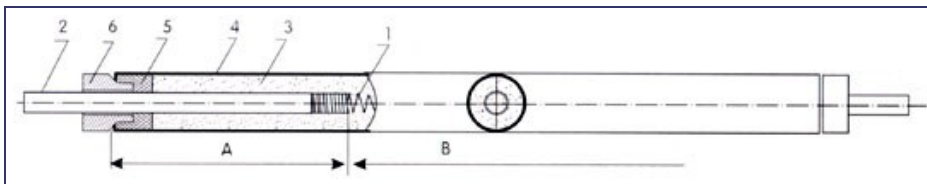

- A - cold end (cold part)
- B - hot zone (hot part)
- 1 - heating coil
- 2 - clamping mandrel
- 3 - insulating material
- 4 - metal sheath (tube)
- 5 - sealing
- 6 - ceramic insulator

### HEATING ELEMENT PARAMETERS

#### Standard dimensions and types of sheaths (tubes)

Ø [mm]	Material			Length [mm]
	Copper	Unalloyed steel (e.g. C10, IF25)	Stainless steel (AISI 321, AISI 316, INCOLOY 800, INCOLOY 825)	
6,4	+	+	+	200 ÷ 4000
8,0	+	-	-	200 ÷ 3150
8,35	-	-	+	200 ÷ 6000
8,5	+	+	+	200 ÷ 4000
10,0	-	-	+	200 ÷ 3400
10,2	-	-	+	200 ÷ 3400
13,0	-	-	+	200 ÷ 3600

Our custom heating element production also comprises non-standard lengths and diameters.

**Diameter tolerance** is  $\pm 0,1$  mm

Standard **length tolerance** is  $\pm 2$  % but may be reduced to  $\pm 1$ mm upon special request.

#### Rated voltage and wattage

Rated voltage and wattage are parameters which may be freely selected depending on individual needs. Rated voltages that are typically used:

24V, 42V, 48V, 65V, 110V, 127V, 220V, 230V, 380V, 400V, 500V

The wattage of an individual heating element may be from several watts to a few kilowatts. The typical rated wattage tolerance is  $\pm 5$ - $10$ %, as per PN-EN 60335-1:1999.

#### Bending and length of cold ends

Every tubular heating element has cold ends on both sides, whose length can be made to match the individual requirements. The minimum length of the cold end is  $\sim 25$  mm.

The heating element may not be bent at cold end extreme points, because then mandrel ends may damage the electrical insulation of the heater.

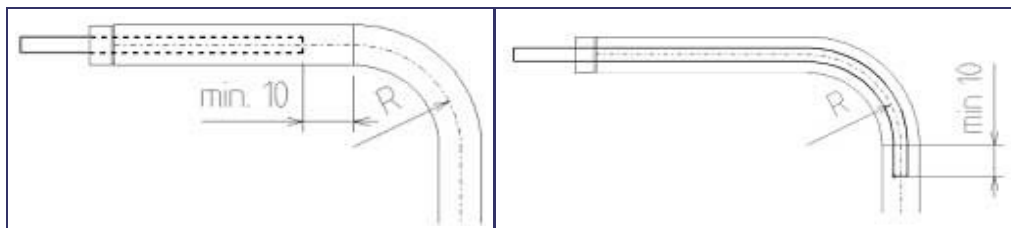

We bend heating elements according to the specific requirements of our customers, based upon samples and/or drawings they submit. The minimum bend radius depends on the diameter of the element and the type of tube, and may in some cases equal as much as half of the outer diameter of the sheath.



**SELECTION CRITERIA**

**Selection of proper heaters**

When selecting a heating element, its designation and working environment play an important role. Dimensions, wattage and surface load depend on a variety of factors. Therefore, the specification of the following parameters is required to match the optimum solution:

- application
- heated medium
- required working temperature
- rated voltage
- rated wattage
- type of electrical connections
- temperature control method
- use of fasteners, if any

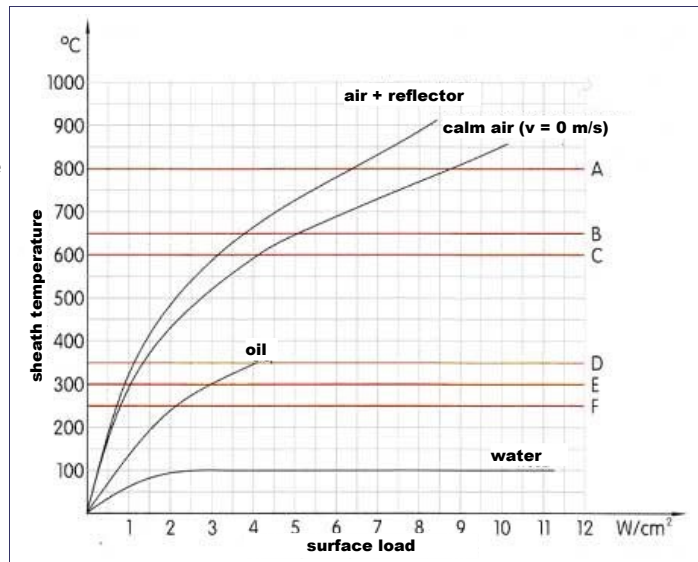

**Working temperature and surface load**

The recommended maximum surface load of a heating element, expressed in W/cm<sup>2</sup> depends on the working environment

Application	Tube material			
	copper	unalloyed steel	alloy steel (AISI 321, AISI 316)	alloy steel (Incoloy 800)
still water	10	-	10	-
water in motion	14	-	14	-
flowing water (flow heaters)	25	-	25	-
water (steam generator)	6	-	6	-
thin oil	-	3.5	3.5	-
thick oil	-	1.2	1.2	-
special heating oil (heaters)	-	12	12	-
still air	-	1.7	5	6
air moving at v=2m/s	-	2	5.5	6.5
air moving at v=10m/s	-	5	10	10

Temperature of tubular heating elements when surface-loaded for different working conditions.

Sheath material	Maximum working temperature
A - alloy steel Incoloy 800, Incoloy 825	max. 800 °C
B - alloy steel AISI-321 (1H18N9T)	max. 650 °C
C - alloy steel AISI-304 (0H18N9)	max. 600 °C
D - carbon steel	max. 350 °C
E - aluminium	max. 300 °C
F -copper, brass	max. 250 °C

**MOUNTING COMPONENTS**

When an individual heating element does not provide the required power, heating units made of several heaters may be used. Individual heaters are connected into a single **head, flange or plate** to ensure functionality, convenience and presentability. Our broad range of standard fasteners caters for all customer requirements, and if non-standard parameters are required, we produce them according to individual orders.

	Formed head	Machined head (cast)
Material	brass, unalloyed steel, stainless steel	
Thread	G1 1/4" G1 1/2" G1" G2" G2 1/2" M48x2 and more	
Number of heating elements	1, 2, 3 or more	

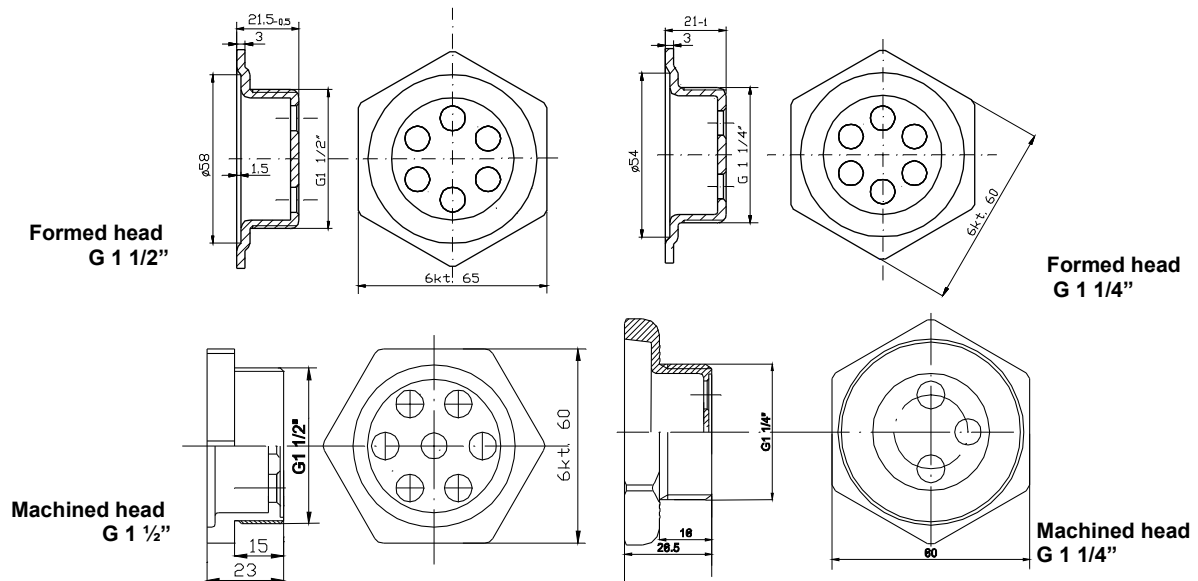

**Mounting bushes** on both ends of the heating element enable its accurate mounting in the working environment. We offer a broad range of standard bushes made of a variety of materials, matching the specific heater. We can also produce them according to the specific customer requirements.

**Bushes soldered to heating element**

Mark	Thread	Length [mm]		Material	Ø [mm]
		Lg	L		
<b>Ø 6,4</b>					
11.0285	M10x1.25	13	16	stainless steel	16
11.0337	M10x1.25	30	38	stainless steel	6-kt 17
11.0429	M12x1.25	13	16	stainless steel	16
11.0303	M14x1.5	25	30	stainless steel	6-kt 19
<b>Ø 6,9</b>					
11.0296	M14x1.5	15	20	brass	6-kt 19
<b>Ø 8,0</b>					
11.0248	M14x1.5	16	21	brass	6-kt 19
11.0257	M14x1.5	22	27	brass	6-kt 19
<b>Ø 8,5</b>					
11.0336	G3/8"	24	30	stainless steel	6-kt 22
11.0412	M14x1.5	15	19	stainless steel	22
11.0302	M14x1.5	25	30	stainless steel	6-kt 19
11.0394	M14x1.5	55	60	stainless steel	6-kt 19
11.0393	M14x1.5	65	70	stainless steel	6-kt 19
11.0380	M14x1.5	16	21	stainless steel	6-kt 19
11.0355	M14x1.5	14	19	stainless steel	18
11.0430	M16x1.5	32	36	stainless steel	22
11.0335	M20x1.5	23	29	stainless steel	30
11.0353	G1/2"	20	25	unalloyed steel	30
11.0287	M14x1.5	20	24	unalloyed steel	20
11.0289	M16x1.5	20	24	unalloyed steel	22
11.0247	M14x1.5	16	21	brass	6-kt 19
11.0292	M14x1.5	15	20	brass	s = 17
11.0256	M14x1.5	22	27	brass	6-kt 19
11.0293	M14x1.5	30	35	brass	s = 17
11.0294	M16x1.0	45	50	brass	s = 17
<b>Ø 10,0</b>					
11.0325	G1/2"	20	25	stainless steel	30
11.0413	M14x1.5	15	19	stainless steel	22
11.0399	M14x1.5	25	30	stainless steel	6-kt 19
11.0354	M16x1.5	20	24	stainless steel	22
11.0299	M14x1.5	20	24	unalloyed steel	20
11.0291	M16x1.5	20	24	unalloyed steel	22
11.0262	G1/2"	20	25	unalloyed steel	30
11.0379	M14x1.5	18	25	brass	6-kt 22
11.0382	M18x1.5	20	24	brass	24
<b>Ø 13,0</b>					
11.0384	G1/2"	29	32	stainless steel	29
11.0409	M18x1.5	20	24	stainless steel	24
11.0423	M18x1.5	30	34	stainless steel	24
11.0418	M24x1.5	16	20	stainless steel	32
11.0371	M22x1.5	25	29	unalloyed steel	32
11.0389	M24x1.5	20	25	unalloyed steel	30

**Bushes clamped to heating element**

Mark	Thread	Length [mm]		Material	Ø [mm]
		Lg	L		
<b>Ø 6,4</b>					
11.0268	M10x1.25	13	22	unalloyed steel <sup>(1)</sup>	16
11.0316	M12x1.25	13	22	unalloyed steel <sup>(1)</sup>	18
11.0281 <sup>(2)</sup>	M12x1.25	15	21	unalloyed steel <sup>(1)</sup>	20
11.0230 <sup>(2)</sup>	M14x1.5	17	23	unalloyed steel <sup>(1)</sup>	22
11.0411 <sup>(2)</sup>	M14x1.5	22	28	unalloyed steel <sup>(1)</sup>	22
<b>Ø 6,9</b>					
11.0288	M14x1.5	15	25	brass <sup>(1)</sup>	20
<b>Ø 8,5</b>					
11.0365	M14x1.5	20	30	stainless steel	f20
11.0286	M14x1.5	20	30	unalloyed steel <sup>(1)</sup>	20
11.0400	M14x1.5	16	26	brass	6-kt 19
02.361.00.0 0.01	M14x1.5	16	28	brass	6-kt 19
11.0414	M14x1.5	20	30	brass	6-kt 19
11.0055	M14x1.5	20	35	brass	fi.20
11.0298	M14x1.5	25	37	brass <sup>(1)</sup>	fi.20
11.0301	M14x1.5	12	22	brass	6-kt 19
11.0232 <sup>(2)</sup>	M14x1.5	17	23	unalloyed steel <sup>(1)</sup>	22
11.0425 <sup>(2)</sup>	M14x1.5	12	18	unalloyed steel <sup>(1)</sup>	22
11.0426 <sup>(2)</sup>	M14x1.5	22	28	unalloyed steel <sup>(1)</sup>	22
<b>Ø 10,0</b>					
11.0295	M14x1.5	10	20	unalloyed steel <sup>(1)</sup>	20
11.0297	M14x1.5	20	30	unalloyed steel <sup>(1)</sup>	20
11.0395	M16x1.5	12	22	unalloyed steel <sup>(1)</sup>	25
11.0290	M16x1.5	20	30	unalloyed steel <sup>(1)</sup>	22
11.0381	M18x1.5	20	30	unalloyed steel <sup>(1)</sup>	25
<b>Ø 13,0</b>					
11.0344	M20x1.5	10	20	stainless steel	30
11.0402	M20x1.5	15	26	unalloyed steel <sup>(1)</sup>	30
11.0345	M18x1.5	20	30	unalloyed steel <sup>(1)</sup>	25

<sup>(1)</sup> Fe/Zn protective coating  
<sup>(2)</sup> bush lapped on heating element

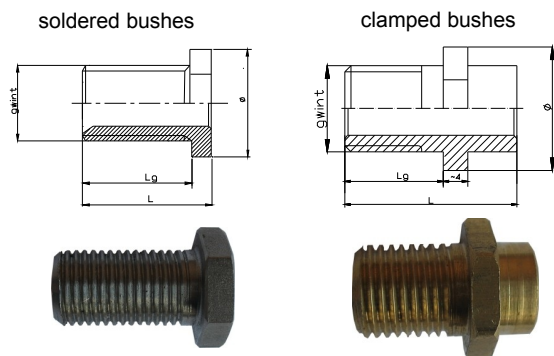

Tubular heating elements

**TYPES OF ELECTRICAL CONNECTIONS**

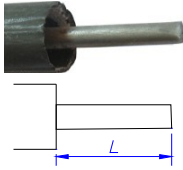
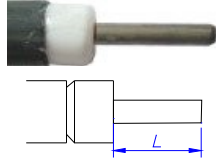
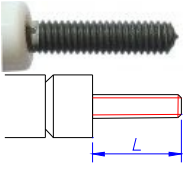
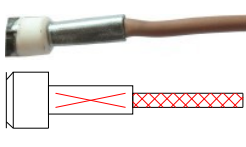
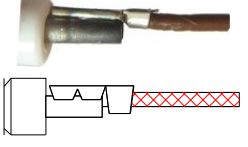
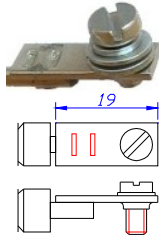
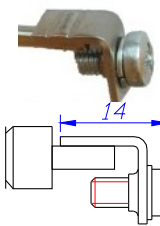
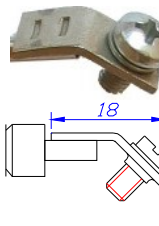
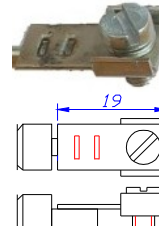
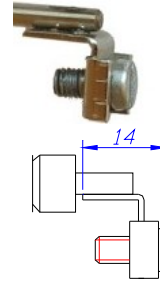
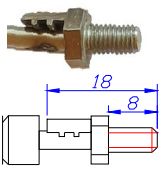
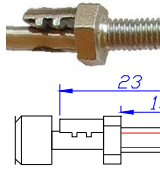
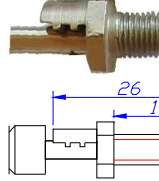
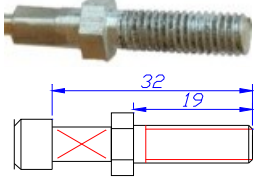
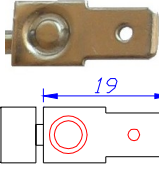
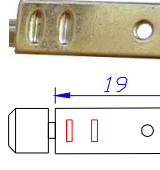
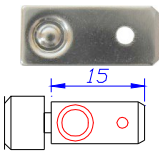
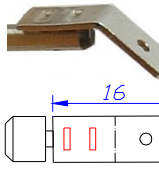
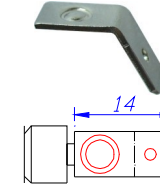
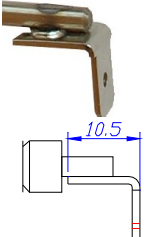
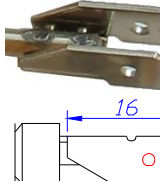
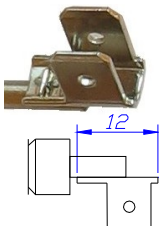
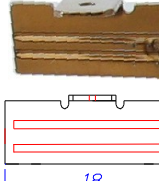
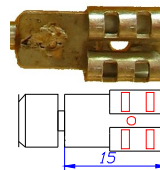
Terminal pins and leads				
 <p><b>B</b> terminal pin (unsealed heating element)</p>	 <p><b>A</b> terminal pin (sealed heating element)</p>	 <p><b>G</b> M4 threaded pin</p>	 <p><b>TL / TP</b> steel str.wire / insulated conductor (clamping bush)</p>	 <p><b>TLZ / TPZ</b> steel str. wire/ insulated conductor (welded to pin)</p>
Threaded clamps				
 <p><b>Z9</b> M4 threaded clamp</p>	 <p><b>Z10</b> M4 threaded clamp</p>	 <p><b>Z11</b> M4 threaded clamp Angle: 45°</p>	 <p><b>Z3</b> M4 threaded tab</p>	 <p><b>Z4</b> M4 threaded tab</p>
 <p><b>Z2</b> thread: M4 welded to pin</p>	 <p><b>Z6</b> thread: M4 welded to pin</p>	 <p><b>Z7</b> thread: M5 welded to pin</p>	 <p><b>Z8</b> thread: M6 clamped on pin</p>	
6.3mm tabs				
 <p><b>W1</b> straight</p>	 <p><b>W2</b> straight</p>	 <p><b>W3</b> straight</p>	 <p><b>WK45</b> angle 45°</p>	 <p><b>WK60</b> angle 60°</p>
 <p><b>WK90</b> angle 90°</p>	 <p><b>WPP</b> double straight</p>	 <p><b>WPK</b> double, angle 90°</p>	 <p><b>LK</b> double connector 90°</p>	 <p><b>N</b> receptacle</p>



HEATING ELEMENTS CATALOGUE

Washing machine heaters

Flange cross section is shown on the next picture.  
Three flange configurations are available:

- with an embedded fuse,
- with a hole in the flange for PTC,
- with a hole in the flange and seal for PTC,

Meaning of letter codes used in the identification code of the heater type:

- **no letter**: full body seal, full body flange, no fuse
- **Z**: full body seal, full body flange, with a fuse
- **ZP**: high full body seal, flange with a hole, with a fuse
- **ZT**: seal and flange with a hole, with a fuse

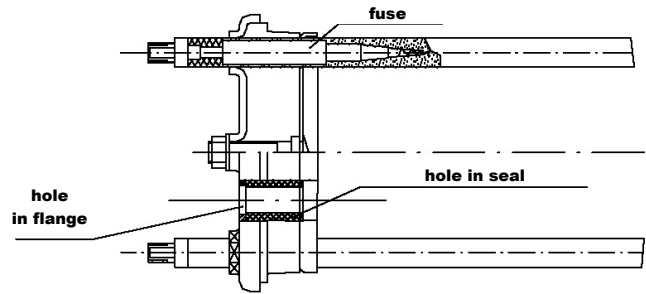

<table border="1"> <thead> <tr> <th>Type</th> <th>Voltage</th> <th>Wattage</th> <th>Tubing type</th> <th>Length [L]</th> <th>Electrical connection</th> <th>Application</th> </tr> </thead> <tbody> <tr> <td>12.811-K</td> <td>230 V</td> <td>2000 W</td> <td>Cu / Ni</td> <td>180 mm</td> <td>double angular tab 90°</td> <td>ARISTON</td> </tr> </tbody> </table>	Type	Voltage	Wattage	Tubing type	Length [L]	Electrical connection	Application	12.811-K	230 V	2000 W	Cu / Ni	180 mm	double angular tab 90°	ARISTON								
Type	Voltage	Wattage	Tubing type	Length [L]	Electrical connection	Application																
12.811-K	230 V	2000 W	Cu / Ni	180 mm	double angular tab 90°	ARISTON																
<table border="1"> <thead> <tr> <th>Type</th> <th>Voltage</th> <th>Wattage</th> <th>Tubing type</th> <th>Length [L]</th> <th>Electrical connection</th> <th>Application</th> </tr> </thead> <tbody> <tr> <td>12.261</td> <td>230 V</td> <td>2000 W</td> <td>Cu</td> <td>250 mm</td> <td>angular tab, 90°</td> <td>POLAR PS, PDH 885</td> </tr> <tr> <td>12.261 W</td> <td>230 V</td> <td>2000 W</td> <td>Cu</td> <td>250 mm</td> <td>double angular tab, 90°</td> <td>WIATKA</td> </tr> </tbody> </table>	Type	Voltage	Wattage	Tubing type	Length [L]	Electrical connection	Application	12.261	230 V	2000 W	Cu	250 mm	angular tab, 90°	POLAR PS, PDH 885	12.261 W	230 V	2000 W	Cu	250 mm	double angular tab, 90°	WIATKA	
Type	Voltage	Wattage	Tubing type	Length [L]	Electrical connection	Application																
12.261	230 V	2000 W	Cu	250 mm	angular tab, 90°	POLAR PS, PDH 885																
12.261 W	230 V	2000 W	Cu	250 mm	double angular tab, 90°	WIATKA																
<table border="1"> <thead> <tr> <th>Type</th> <th>Voltage</th> <th>Wattage</th> <th>Tubing type</th> <th>Length [L]</th> <th>Electrical connection</th> <th>Application</th> </tr> </thead> <tbody> <tr> <td>12.811-C</td> <td>230 V</td> <td>2000 W</td> <td>Cu / Ni</td> <td>180 mm</td> <td>double angular tab, 90°</td> <td>CANDY</td> </tr> </tbody> </table>	Type	Voltage	Wattage	Tubing type	Length [L]	Electrical connection	Application	12.811-C	230 V	2000 W	Cu / Ni	180 mm	double angular tab, 90°	CANDY								
Type	Voltage	Wattage	Tubing type	Length [L]	Electrical connection	Application																
12.811-C	230 V	2000 W	Cu / Ni	180 mm	double angular tab, 90°	CANDY																
<table border="1"> <thead> <tr> <th>Type</th> <th>Voltage</th> <th>Wattage</th> <th>Tubing type</th> <th>Length [L]</th> <th>Electrical connection</th> <th>Application</th> </tr> </thead> <tbody> <tr> <td>12.811</td> <td>230 V</td> <td>2000 W</td> <td>Cu</td> <td>215 mm</td> <td>double angular tab, 90°</td> <td>POLAR PDP</td> </tr> </tbody> </table>	Type	Voltage	Wattage	Tubing type	Length [L]	Electrical connection	Application	12.811	230 V	2000 W	Cu	215 mm	double angular tab, 90°	POLAR PDP								
Type	Voltage	Wattage	Tubing type	Length [L]	Electrical connection	Application																
12.811	230 V	2000 W	Cu	215 mm	double angular tab, 90°	POLAR PDP																

Type	Voltage	Wattage	Tubing type	Length [L]	Electrical connection	Application
02.843	230 V	2000 W	Cr / Ni	L1= 210 mm, L2= 27 mm, Angle = 45°	straight tab	BOSCH, AMICA, SIEMENS

Type	Voltage	Wattage	Tubing type	Length [L]	Electrical connection	Application
02.581	230 V	2000 W	Cr / Ni	L1=140 mm , L2 = 50 mm , Angle = 30°	double angular tab, 90°	ARDO, WHIRLPOOL, CANDY, ARISTON



flange with a hole for PTC

Type	Voltage	Wattage	Tubing type	Length [L]	Electrical connection	Application
02.843-T	230 V	2000 W	Cr / Ni	L1 = 215mm, L2 = 22mm, Angle = 45°	straight tab	BOSCH, AMICA, SIEMENS

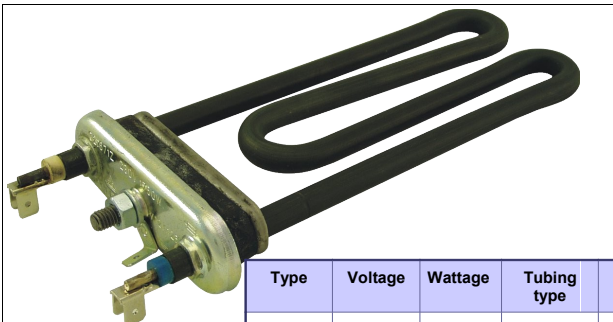
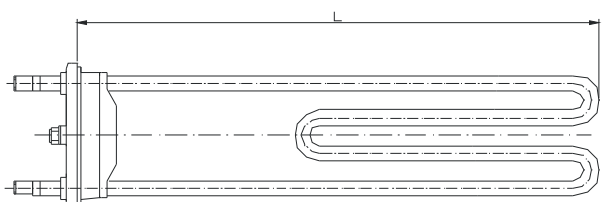

Type	Voltage	Wattage	Tubing type	Length [L]	Electrical connection	Application
02.844-T	230 V	2000 W	Cr / Ni	235 mm	double angular tab, 90°	BOSCH, SIEMENS, CONSTRUCTA

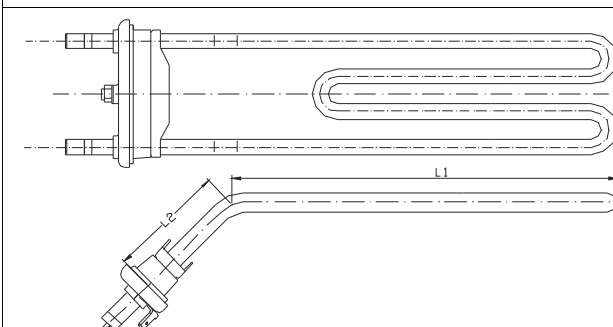
Type	Voltage	Wattage	Tubing type	Length [L]	Electrical connection	Application
02.671	230 V	1750 W	Cr / Ni	165 mm	double angular tab, 90°	POLAR SL
02.401	230 V	2000 W	Cr / Ni	200 mm	single angular tab, 90°	AMICA, CANDY, ZANUSSI, WHIRLPOOL
02.841	230 V	2000 W	Cr / Ni	250 mm	double angular tab, 90°	POLAR PS, WIATKA, PDH885, OTHER
21.151	230 V	1935 W	Cr / Ni	200 mm	double angular tab, 90°	MASTERCOOK

Type	Voltage	Wattage	Tubing type	Length [L]	Electrical connection	Application
12.811-I	230 V	2000 W	Cu / Ni	L1 = 163mm, L2 = 21 mm, Angle = 45°	double angular tab, 90°	AMICA, INDESIT

Type	Voltage	Wattage	Tubing type	Length [L]	Electrical connection	Application
12.811-A	230 V	2000 W	Cu / Ni	L1 = 145mm, L2 = 45mm, Angle = 30°	angular tab, 90°	ARDO

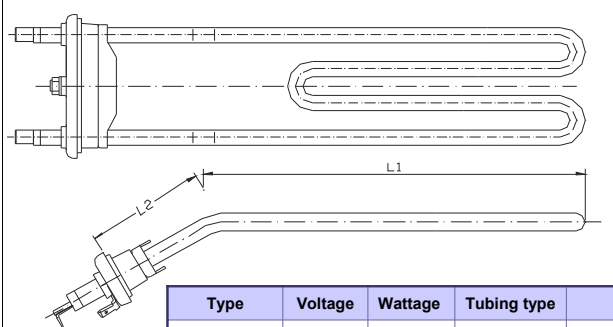

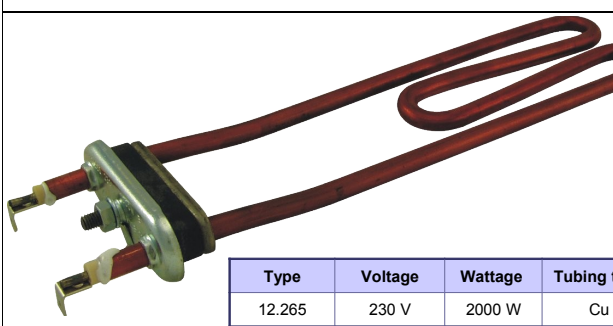
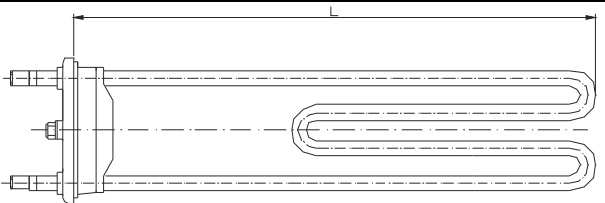

Type	Voltage	Wattage	Tubing type	Length [L]	Electrical connection	Application
12.265	230 V	2000 W	Cu	275 mm	angular tab, 90°	PDG585, GRACJA, DALIA, DAFNA

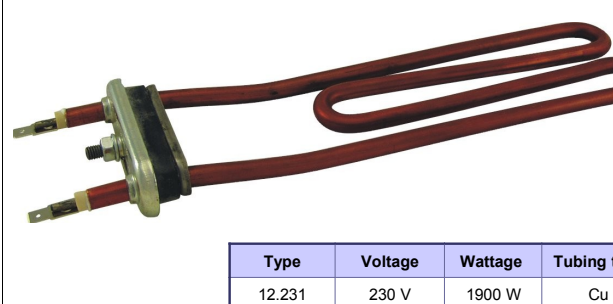
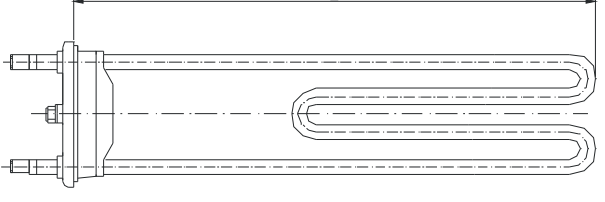

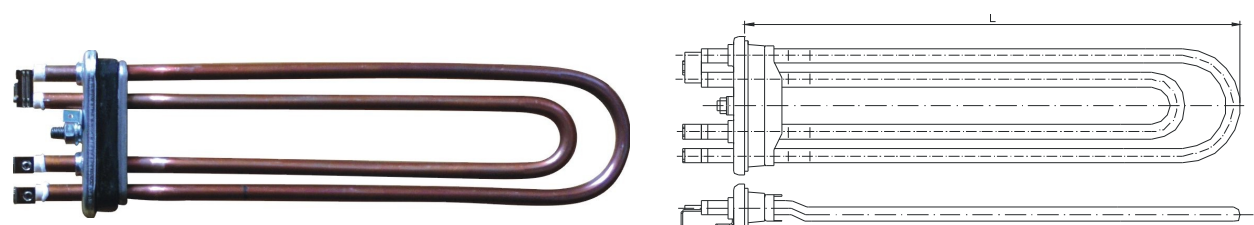

Type	Voltage	Wattage	Tubing type	Length [L]	Electrical connection	Application
12.231	230 V	1900 W	Cu	300 mm	tab	DIANA





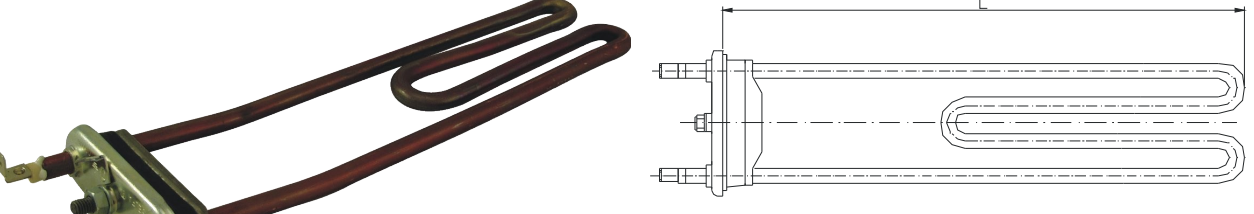

Type	Voltage	Wattage	Tubing type	Length [L]	Electrical connection	Application
40.121	230 V	2000 W	Cu	280 mm	angular tab, 90°	LUNA



Type	Voltage	Wattage	Tubing type	Length [L]	Electrical connection	Application
12.801	230 V	2000 W	Cu	290 mm	angular tab, 90°	POLAR PDN



Type	Voltage	Wattage	Tubing type	Length [L]	Electrical connection	Application
18.011	230 V	1700 W	Cu / Ni	L = 205 mm, B = 95 mm	straight tab	ŚWIATOWIT



Type	Voltage	Wattage	Tubing type	Diameter [Ø]	Electrical connection	Application
12.901	230 V	2000 W	Cu / Ni	190 mm	tab	WM 600

**WASHING MACHINE HEATING ELEMENTS WITH A THERMAL FUSE**

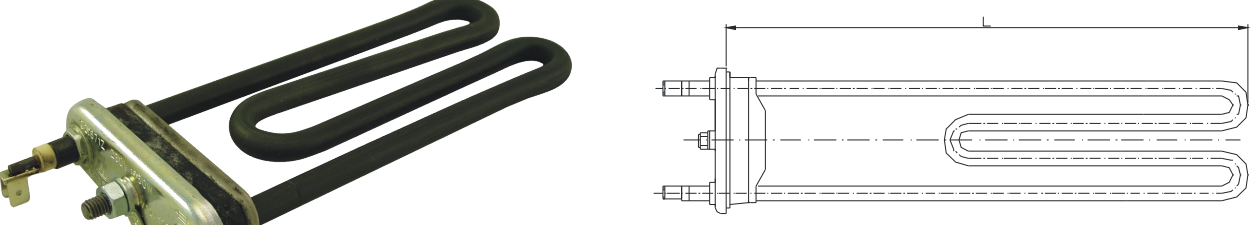

Type	Voltage	Wattage	Tubing type	Length [L]	Electrical connection	Application
02.671-Z	230 V	1750 W	Cr / Ni	165 mm	double angular tab, 90°	POLAR SL348X, CANDY, BOSCH
02.851-Z	230 V	1900 W	Cr / Ni	205 mm		CANDY, ZANUSSI, POLAR SL346X, WHIRLPOOL

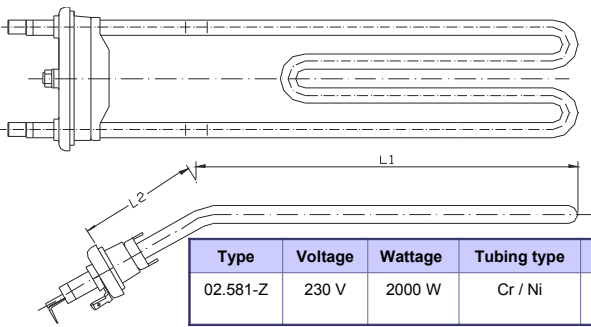

Type	Voltage	Wattage	Tubing type	Length [L]	Electrical connection	Application
02.581-Z	230 V	2000 W	Cr / Ni	L1 = 140 mm, L2 = 50 mm, Angle = 30°	double angular tab, 90°	ARDO, WHIRLPOOL, CANDY, ARISTON

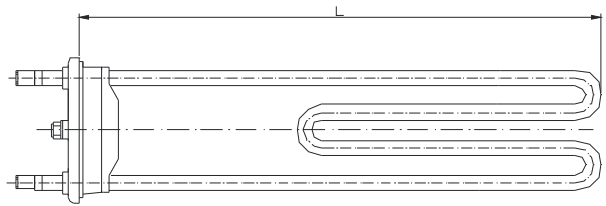
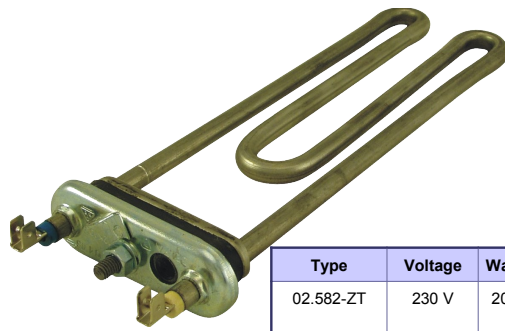

Type	Voltage	Wattage	Tubing type	Length [L]	Electrical connection	Application
02.582-ZT	230 V	2000 W	Cr / Ni	L = 200 mm	angular tab 90°	CANDY, ZANUSSI, WHIRLPOOL, AMICA, POLAR SL346X, BOSCH, SIEMENS
02.842-ZT	230 V	2000 W	Cr / Ni	L = 235 mm	double angular tab, 90°	WHIRLPOOL

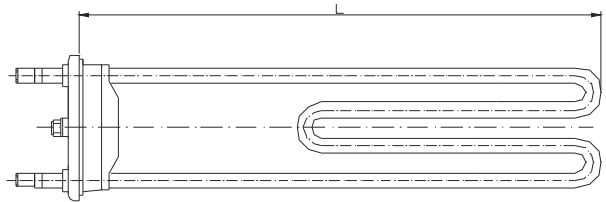
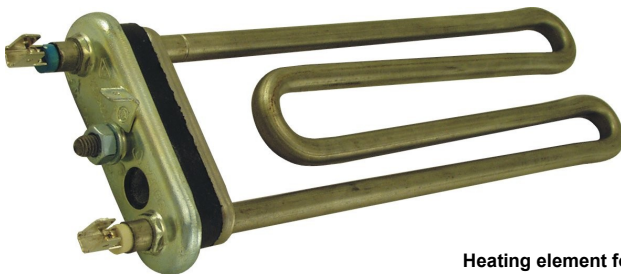

Heating element for washing machine with plastic drum - seal height approx. 18 mm

Type	Voltage	Wattage	Tubing type	Length [L]	Electrical connection	Application
02.851-ZP	230 V	1900 W	Cr / Ni	L = 205 mm	double angular tab, 90°	CANDY, ZANUSSI, POLAR SL346X, WHIRLPOOL
02.845-ZP	230 V	2000 W	Cr / Ni	L = 235 mm		WHIRLPOOL (with an option to bore a hole in the seal for PTC)

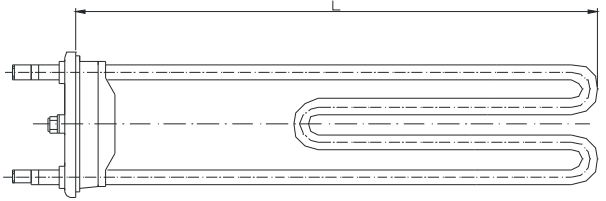
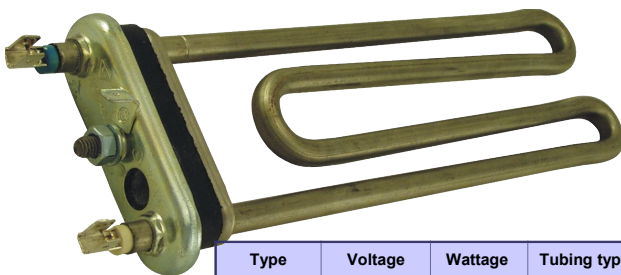

Seal without a collar

Type	Voltage	Wattage	Tubing type	Length [L]	Electrical connection	Application
02.847-ZT	230 V	2000 W	Cr / Ni	235 mm	double angular tab, 90°	WHIRLPOOL

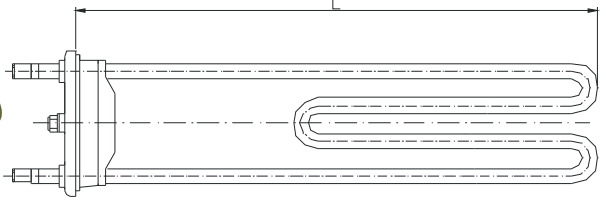
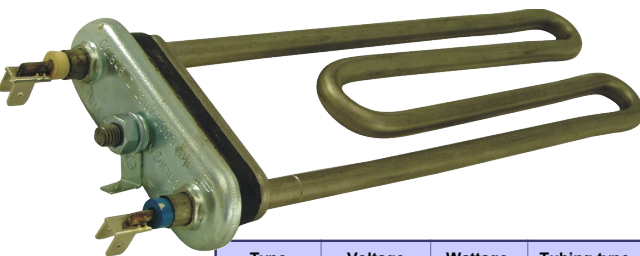

Seal without a collar

Type	Voltage	Wattage	Tubing type	Length [L]	Electrical connection	Application
02.846-Z	230 V	2000 W	Cr / Ni	235 mm	double angular tab, 90°	WHIRLPOOL

### Heating elements for industrial washers

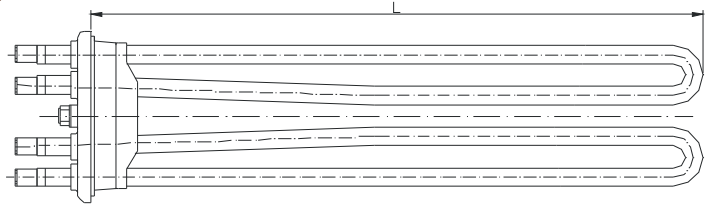
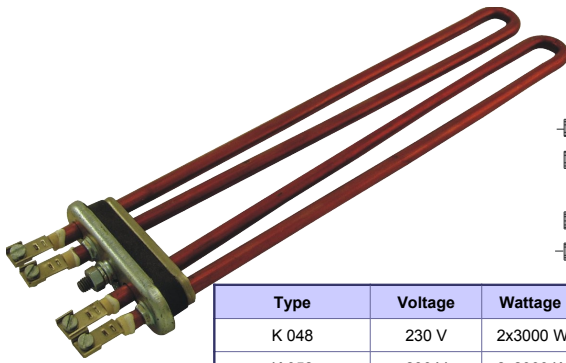

Type	Voltage	Wattage	Tubing type	Length [L]	Electrical connection
K 048	230 V	2x3000 W	Cu	470 mm	M4 threaded clamp
K 052	230 V	2x2000 W	Cu	300 mm	

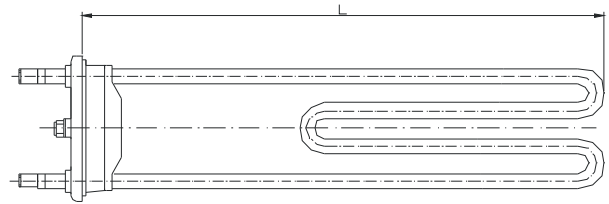
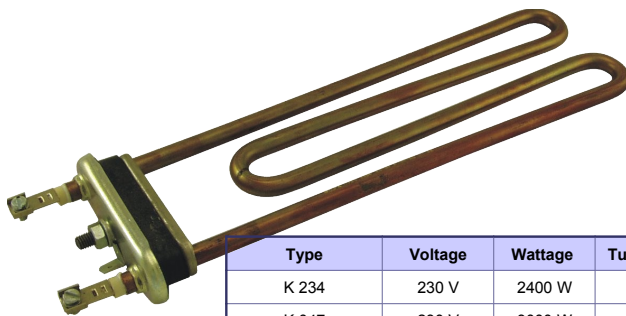

Type	Voltage	Wattage	Tubing type	Length [L]	Electrical connection
K 234	230 V	2400 W	Cu	255 mm	M4 threaded clamp
K 047	230 V	3000 W	Cu	305 mm	M4 threaded clamp
K 235	400 V	5500 W	Cu	485 mm	M4 threaded clamp
02.841	230 V	2000 W	Cr / Ni	250 mm	double angular tab, 90°

### Heating elements for water heaters

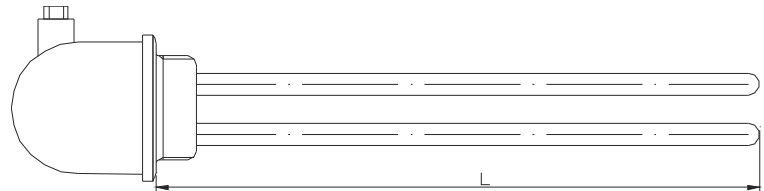
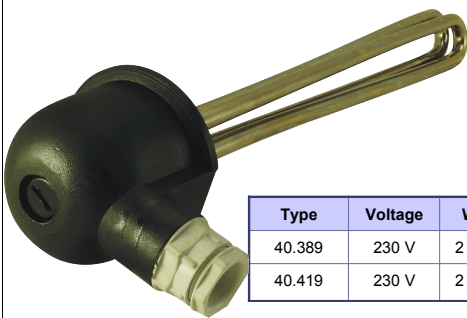

Type	Voltage	Wattage	Tubing type	Length [L]	Thread	Electrical connection	Application
40.389	230 V	2 x 1500 W	Cu / Ni	300 mm	1 1/4"	angular tab	for boilers, water heaters, central heating systems
40.419	230 V	2 x 2000 W	Cu / Ni	380 mm	1 1/4"		

*Do not use for stainless steel tanks*

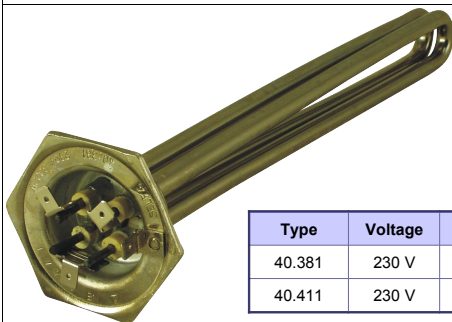

Type	Voltage	Wattage	Tubing type	Length [L]	Thread	Electrical connection	Application
40.381	230 V	2 x 1500 W	Cu / Ni	300 mm	1 1/4"	angular tab	for boilers, central heating systems
40.411	230 V	2 x 2000 W	Cu / Ni	380 mm	1 1/4"		



*Do not use for stainless steel tanks*

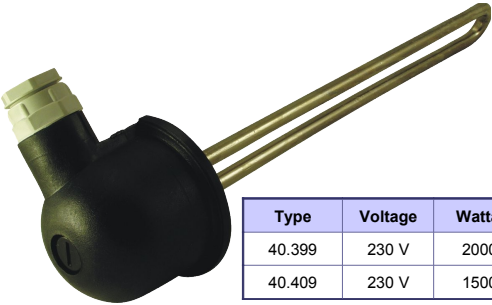
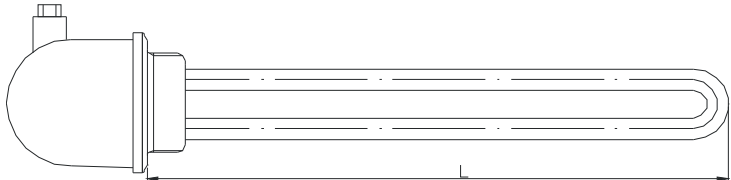

Type	Voltage	Wattage	Tubing type	Length [L]	Thread	Electrical connection	Application
40.399	230 V	2000 W	Cu / Ni	380 mm	1 1/4"	angular tab	for boilers, central heating systems
40.409	230 V	1500 W	Cu / Ni	300 mm	1 1/4"		

*Do not use for stainless steel tanks*

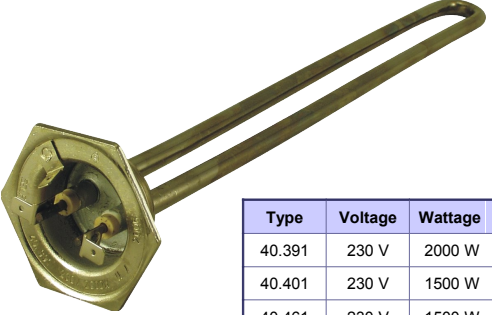
Type	Voltage	Wattage	Tubing type	Length [L]	Thread	Electrical connection	Application
40.391	230 V	2000 W	Cu / Ni	380 mm	1 1/4"	angular tab	for IRMET, GALMET boilers
40.401	230 V	1500 W	Cu / Ni	300 mm	1 1/4"		
40.461	230 V	1500 W	Cu / Ni	400 mm	1 1/4"		

*Do not use for stainless steel tanks*

Type	Voltage	Wattage	Tubing type	Length [L]	Thread	Electrical connection	Application
40.821	230 V	2000 W	Cu / Ni	400 mm	1 1/4"	angular tab	for boilers
40.402	230 V	1500 W	Cu / Ni	300 mm	1 1/4"		

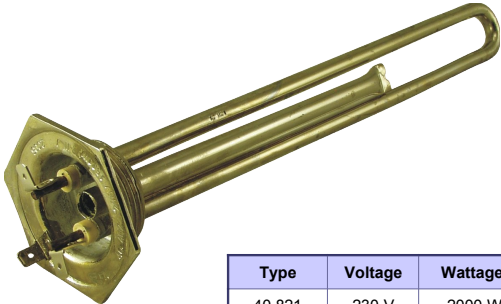
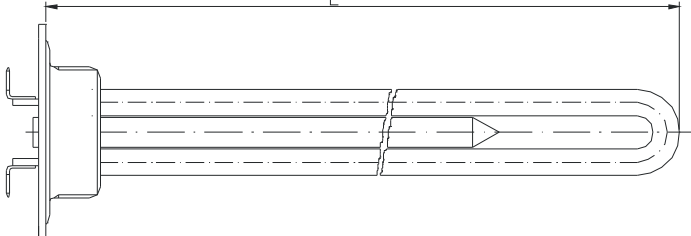
contains tube for temperature sensor

*Do not use for stainless steel tanks*



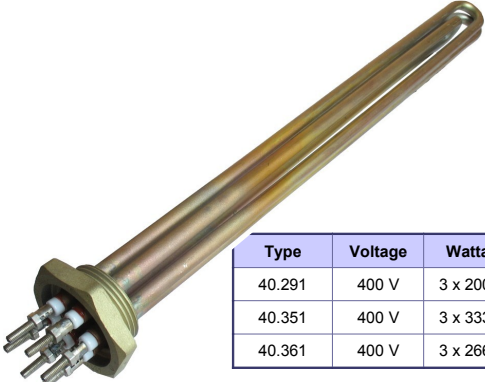
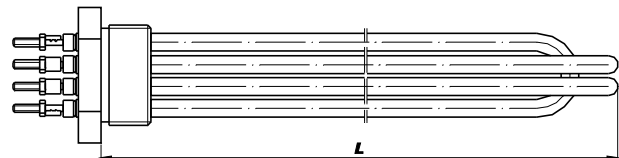

Type	Voltage	Wattage	Tubing type	Length [L]	Thread	Electrical connection	Application
40.291	400 V	3 x 2000 W	Cu	330 mm	1 1/4"	M4 threaded clamp	central heating units, industrial water heaters, steam generators.
40.351	400 V	3 x 3333 W	Cu	430 mm	1 1/4"		
40.361	400 V	3 x 2666 W	Cu	430 mm	1 1/4"		

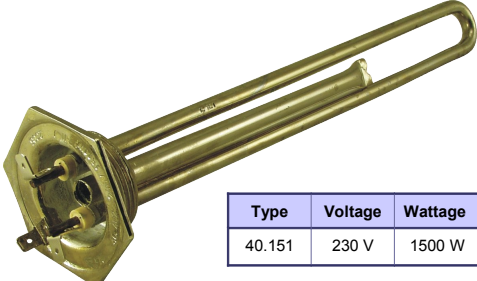
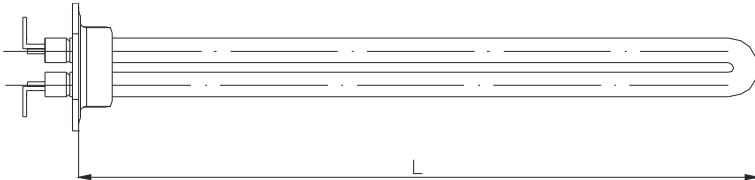
*Do not use for stainless steel tanks*

Type	Voltage	Wattage	Tubing type	Length [L]	Thread	Electrical connection	Application
40.151	230 V	1500 W	Cr / Ni	400 mm	1 1/4"	angular tab	<b>for stainless steel tanks</b>

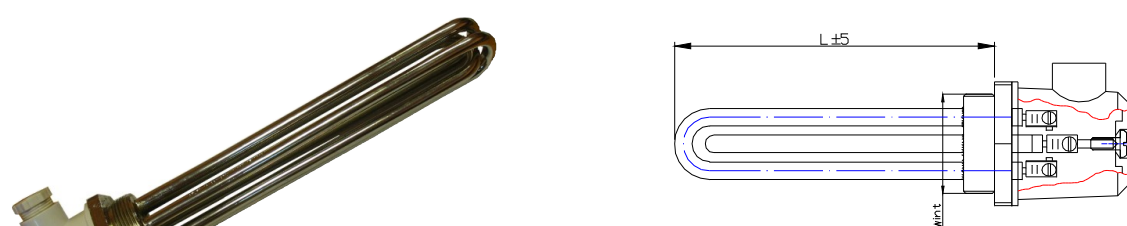

Type	Voltage	Wattage	Tubing type	Length [L]	Thread	Electrical connection	Application
40.489	230 V	3 x 1500 W	Cu / Ni	400 mm	1 1/2"	M4 threaded clamp	for boilers, water heaters, central heating systems
40.499	230 V	3 x 2000 W	Cu / Ni	400 mm	1 1/2"		

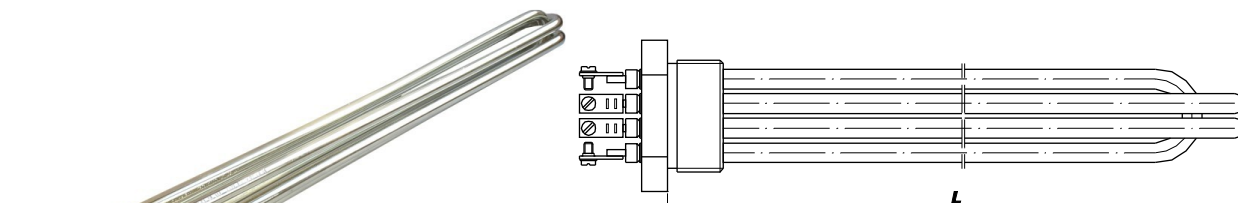

Type	Voltage	Wattage	Tubing type	Length [L]	Thread	Electrical connection	Application
40.481	230 V	3 x 1500 W	Cu / Ni	400 mm	1 1/2"	M4 threaded pin	for boilers, water heaters, central heating systems
40.491	230 V	3 x 2000 W	Cu / Ni	400 mm	1 1/2"		

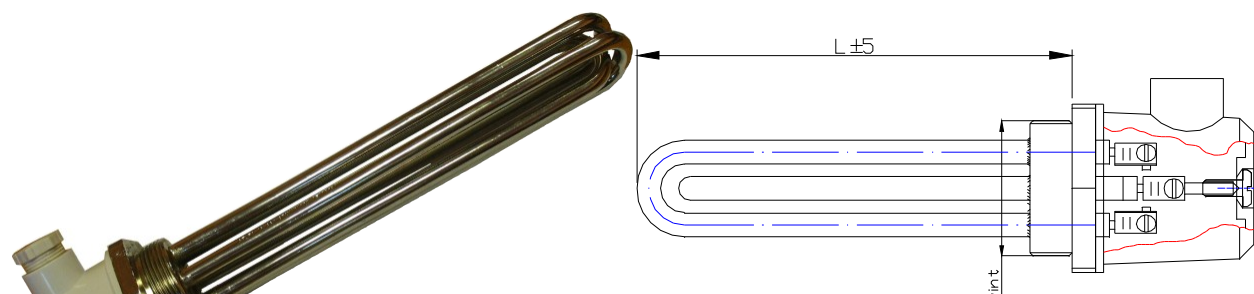

Type	Voltage	Wattage	Tubing type	Length L [mm]	Thread	Electrical connection	Application	Protection level
40.911	3x230 V	3x800 W	Cu / Ni	203	M48 x 2	M4 threaded clamp	water heaters	IP 54
40.921	3x230 V	3x1000 W	Cu / Ni	240	M48 x 2			
40.931	3x230 V	3x1333 W	Cu / Ni	303	M48 x 2			
40.941	3x230 V	3x1500 W	Cu / Ni	333	M48 x 2			
40.951	3x230 V	3x2000 W	Cu / Ni	428	M48 x 2			
40.961	3x400 V	3x2500 W	Cu / Ni	520	M48 x 2			
40.971	3x230 V	3x2000W	stainless steel	340	G 1 1/2"	M4 pin	steam generators	IP 54
A2361	3x400 V	3x1000 W	stainless steel	120	G 1 1/2"	M4 threaded clamp		
A2362	3x400 V	3x1500 W	stainless steel	250	G 1 1/2"			
A2363	3x400 V	3x1700 W	stainless steel	250	G 1 1/2"			
A2364	3x400 V	3x2333 W	stainless steel	250	G 1 1/2"			

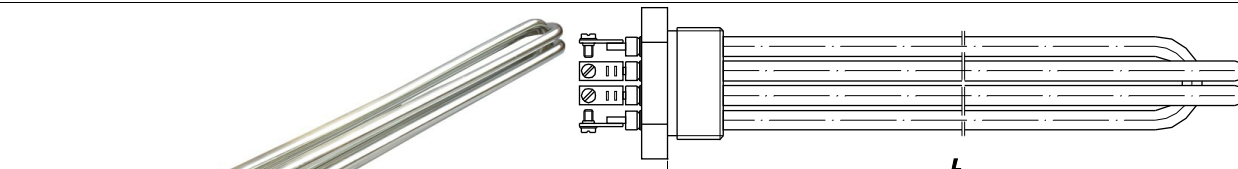

Type	Voltage	Wattage	Tubing type	Length L [mm]	Thread	Electrical connection	Application
A2365	3 x 400 V	3 x 2000 W	stainless steel	390	G 1 1/2"	M4 threaded clamp	steam generators; for stainless steel tanks
A2366	3 x 400 V	3 x 2666 W	stainless steel	480	G 1 1/2"		
A2367	3 x 400 V	3 x 3333 W	stainless steel	480	G 1 1/2"		
A2368	3 x 400 V	3 x 4000 W	stainless steel	600	G 1 1/2"		

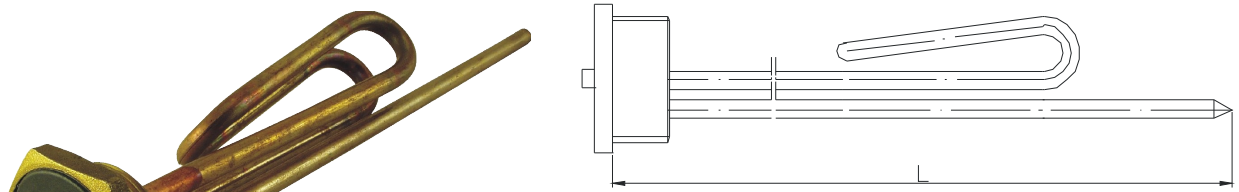

Type	Voltage	Wattage	Tubing type	Length [L]	Thread	Electrical connection	Application	
43.001	230 V	1500 W	Cu	275 mm	1 1/4"	receptacle for tab	for water heaters	
43.007	230 V	2000 W	Cu	275 mm	1 1/4"			
contains tube for temperature sensor option to purchase with the directly mounted thermostat: type <a href="#">43.004</a>								

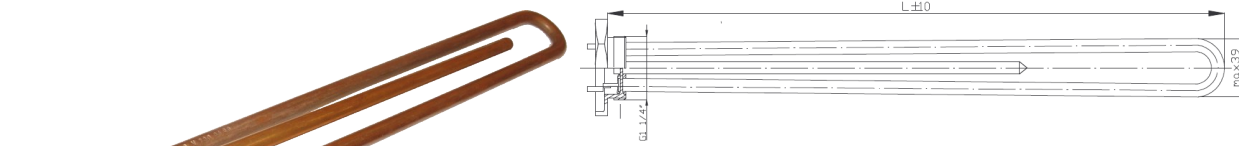

Type	Voltage	Wattage	Tubing type	Length [L]	Thread	Electrical connection	Application	
43.008	220 V	1500 W	Cu	280 mm	1 1/4"	receptacle for tab	central heating units, industrial water heaters, steam generators	
43.009	220 V	2000 W	Cu	340 mm	1 1/4"			
43.010	220 V	2500 W	Cu	400 mm	1 1/4"			
43.061	220 V	3000 W	Cu	400 mm	1 1/4"			
contains tube for temperature sensor option to purchase with the directly mounted thermostat: type <a href="#">43.004</a>								

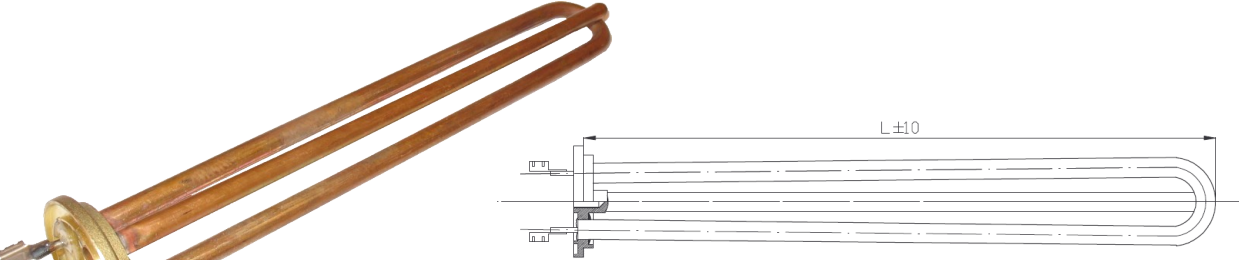

Type	Voltage	Wattage	Tubing type	Length [L]	Thread	Electrical connection	Application	
43.062	220 V	1500 W	Cu	270 mm	Ø 48	receptacle for tab	central heating units, industrial water heaters, steam generators	
43.063	220 V	2000 W	Cu	270 mm	Ø 48			
contains tube for temperature sensor option to purchase with the directly mounted thermostat: type <a href="#">43.004</a>								

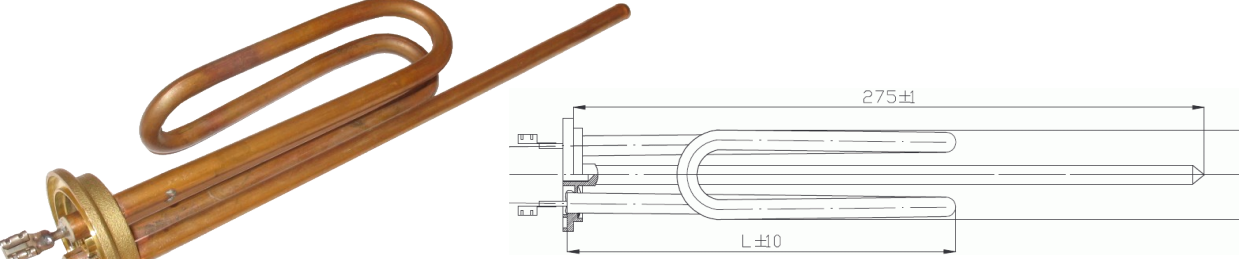

Type	Voltage	Wattage	Tubing type	Length [L]	Thread	Electrical connection	Application	
43.064	220 V	2000 W	Cu	155 mm	Ø 48	receptacle for tab	central heating units, industrial water heaters, steam generators	
contains tube for temperature sensor option to purchase with the directly mounted thermostat: type <a href="#">43.004</a>								

Thermostat 43.004  
- description: page 57 of the catalogue

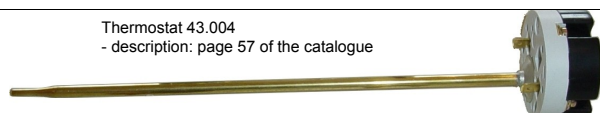

Tubular heating elements





Type	Voltage	Wattage	Tubing type	Length [L]	Thread	Electrical connection	Application
40.871	230 V	1500 W	Cu	max. 288 mm	1 1/4"	straight tab	central heating units, industrial water heaters, steam generators
40.891	230 v	2000 W	Cu	max. 288 mm	1 1/4"		

contains tube for temperature sensor



Type	Voltage	Wattage	Tubing type	Length [L]	Thread	Electrical connection	Application
40.851	230 V	1500 W	Cu	max. 285 mm	1 1/4"	straight tab	central heating units, industrial water heaters, steam generators
40.881	230 V	2000 W	Cu	max. 285 mm	1 1/4"		

contains tube for temperature sensor

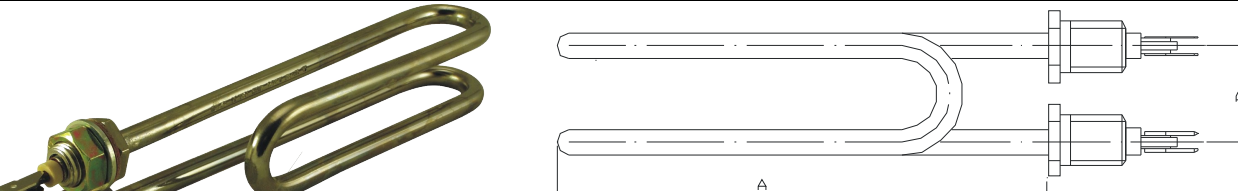

Type	Voltage	Wattage	Tubing type	Dimension [mm]		Ø [mm]	Thread	Electrical connection	Application
				A	B				
17.051	230 V	1500 W	Cu / Ni	195	27	8	M14x1,5	double tab	water heaters
17.313	230 V	2000 W	Cu / Ni	235	27	8	M14x1,5		
12.841	230 V	3000 W	Cu / Ni	325	33	8,5	M14x1,5		

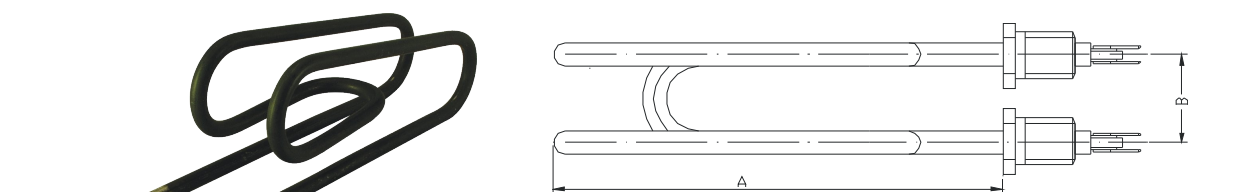

Type	Voltage	Wattage	Tubing type	Dimension [mm]		Ø [mm]	Thread	Electrical connection	Application
				A	B				
01.601 <sup>†)</sup>	230 V	1500 W	stainless steel	200	34	6,4	M14x1,5	double tab	ZELMECH,ELEKTROMET, GALMET

<sup>†)</sup> Do not use for stainless steel tanks

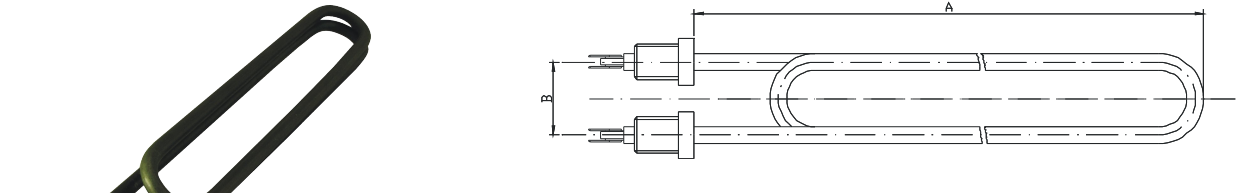

Type	Voltage	Wattage	Tubing type	Dimension [mm]		Ø [mm]	Thread	Electrical connection	Application
				A	B				
01.571 <sup>†)</sup>	230 V	4000 W	stainless steel	470	50	6,4	M14x1,5	double tab	ELTERM
01.641 <sup>†)</sup>	230 V	3000 W		400	50	6,4	M14x1,5		ELTERM
01.721 <sup>†)</sup>	230 V	1500 W		240	30	6,4	M14x1,5		BIAWAR
01.731 <sup>†)</sup>	230 V	2000 W		315	30	6,4	M14x1,5		BIAWAR

<sup>†)</sup> Do not use for stainless steel tanks

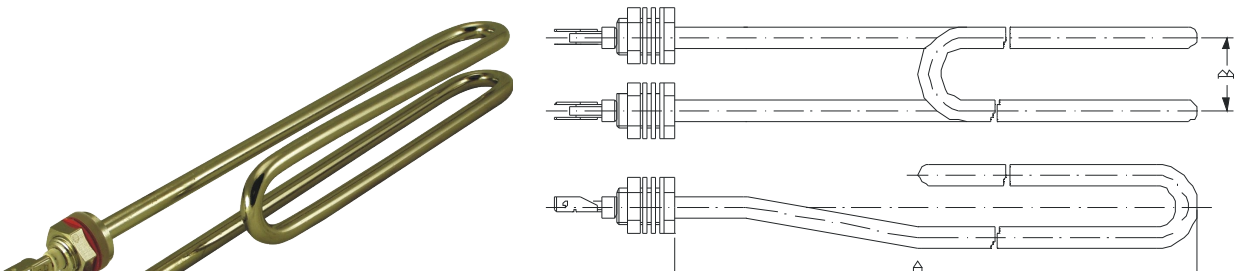

Type	Voltage	Wattage	Tubing type	Dimension [mm]		Ø [mm]	Thread	Electrical connection	Application
				A	B				
12.041	230 V	3350 W	Cu / Ni	490	37	8,5	M14x1,5	double tab	heat boilers

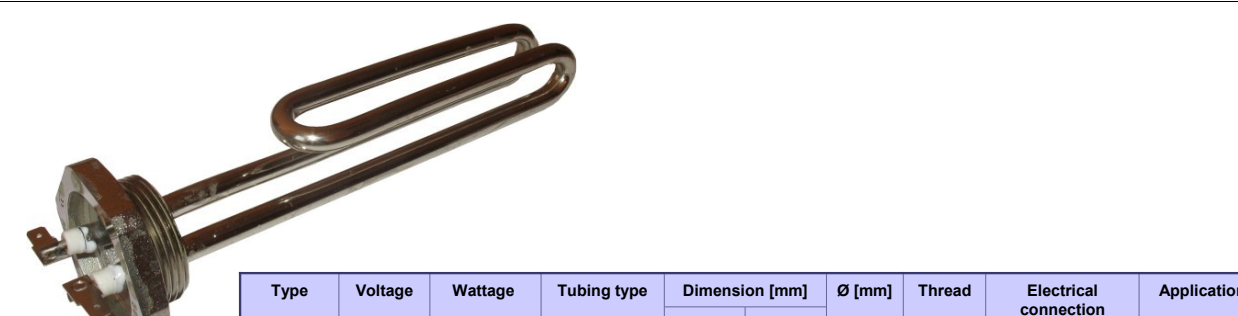

Type	Voltage	Wattage	Tubing type	Dimension [mm]		Ø [mm]	Thread	Electrical connection	Application
				A	B				
40.311	220 V	1600 W	Cu / Ni	218	20	8,5	G 1 1/4"	tab	

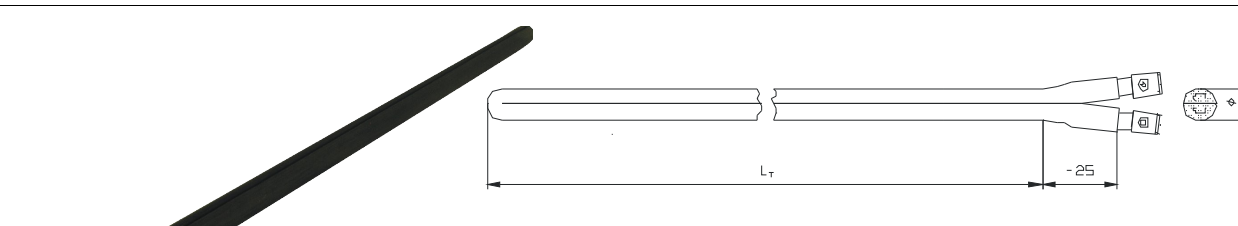

Type	Voltage	Wattage	Tubing type	Dimension L <sub>T</sub>	Ø [mm]	Electrical connection	Application
07.001	230 V	600 W	stainless steel	250 mm	12	straight tab	Electrolux
07.011	230 V	800 W		320 mm	12		
07.021	230 V	900 W		395 mm	12		
07.031	230 V	1000 W		415 mm	12		
07.041	230 V	1200 W		395 mm	12		
07.051	230 V	1200 W		490 mm	12		
07.061	230 V	1500 W		490 mm	12		
07.071	230 V	1500 W		640 mm	12		

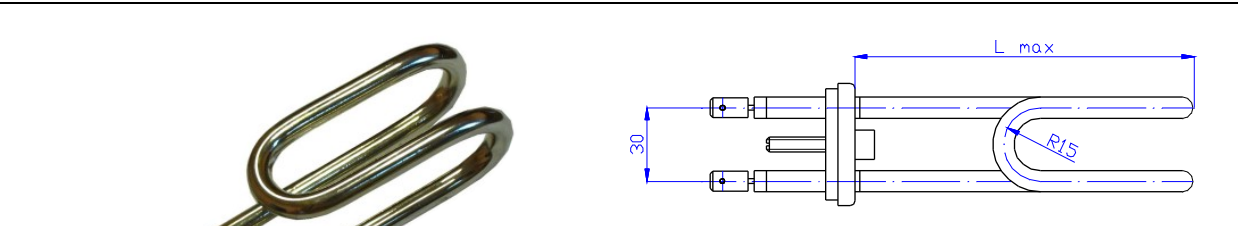

Type	Voltage	Wattage	Tubing type	Dimension [mm]		Ø [mm]	Electrical connection	Application
				L <sub>max</sub>	B			
18.451	230 V	850 W	Cu / Ni	138	30	8	straight tab	water heaters
18.461	230 V	1350 W	Cu / Ni	193	30	8		
18.471	230 V	1600 W	Cu / Ni	283	30	8		
18.481	230 V	1750 W	Cu / Ni	253	30	8		
18.491	230 V	2000 W	Cu / Ni	358	30	8		
18.501	230 V	2400 W	Cu / Ni	358	30	8		

	<table border="1"> <thead> <tr> <th rowspan="2">Type</th> <th rowspan="2">Voltage</th> <th rowspan="2">Wattage</th> <th rowspan="2">Tubing type</th> <th colspan="2">Dimension [mm]</th> <th rowspan="2">Ø [mm]</th> <th rowspan="2">Thread</th> <th rowspan="2">Electrical connection</th> <th rowspan="2">Application</th> </tr> <tr> <th>A</th> <th>B</th> </tr> </thead> <tbody> <tr> <td>01.551<sup>1)</sup></td> <td>230 V</td> <td>2000 W</td> <td>stainless steel</td> <td>470</td> <td>50</td> <td>6,4</td> <td>M14x1,5</td> <td>straight tab</td> <td>ELTERM</td> </tr> </tbody> </table>	Type	Voltage	Wattage	Tubing type	Dimension [mm]		Ø [mm]	Thread	Electrical connection	Application	A	B	01.551 <sup>1)</sup>	230 V	2000 W	stainless steel	470	50	6,4	M14x1,5	straight tab	ELTERM
Type	Voltage					Wattage	Tubing type					Dimension [mm]		Ø [mm]	Thread	Electrical connection	Application						
		A	B																				
01.551 <sup>1)</sup>	230 V	2000 W	stainless steel	470	50	6,4	M14x1,5	straight tab	ELTERM														

	<table border="1"> <thead> <tr> <th rowspan="2">Type</th> <th rowspan="2">Voltage</th> <th rowspan="2">Wattage</th> <th rowspan="2">Tubing type</th> <th colspan="2">Dimension [mm]</th> <th rowspan="2">Ø [mm]</th> <th rowspan="2">Thread</th> <th rowspan="2">Electrical connection</th> <th rowspan="2">Application</th> </tr> <tr> <th>A</th> <th>B</th> </tr> </thead> <tbody> <tr> <td>12.181</td> <td>230 V</td> <td>1400 W</td> <td>Cu / Ni.</td> <td>240</td> <td>72</td> <td>8,5</td> <td>M14x1,5</td> <td>straight tab</td> <td>water heaters</td> </tr> </tbody> </table>	Type	Voltage	Wattage	Tubing type	Dimension [mm]		Ø [mm]	Thread	Electrical connection	Application	A	B	12.181	230 V	1400 W	Cu / Ni.	240	72	8,5	M14x1,5	straight tab	water heaters
Type	Voltage					Wattage	Tubing type					Dimension [mm]		Ø [mm]	Thread	Electrical connection	Application						
		A	B																				
12.181	230 V	1400 W	Cu / Ni.	240	72	8,5	M14x1,5	straight tab	water heaters														

	<table border="1"> <thead> <tr> <th rowspan="2">Type</th> <th rowspan="2">Voltage</th> <th rowspan="2">Wattage</th> <th rowspan="2">Tubing type</th> <th colspan="2">Dimension [mm]</th> <th rowspan="2">Ø [mm]</th> <th rowspan="2">Thread</th> <th rowspan="2">Electrical connection</th> <th rowspan="2">Application</th> </tr> <tr> <th>A</th> <th>B</th> </tr> </thead> <tbody> <tr> <td>12.182</td> <td>230 V</td> <td>1400 W</td> <td>Cu / Ni.</td> <td>410</td> <td>37</td> <td>8,5</td> <td>M14x1,5</td> <td>straight tab</td> <td>water heaters</td> </tr> <tr> <td>12.101</td> <td>230 V</td> <td>1000 W</td> <td>Cu / Ni</td> <td>290</td> <td>72</td> <td>8,5</td> <td>M14x1,5</td> <td>straight tab</td> <td>water heaters</td> </tr> <tr> <td>17.341</td> <td>230 V</td> <td>2000 W</td> <td>Cu / Ni</td> <td>400</td> <td>56</td> <td>8</td> <td>M14x1,5</td> <td>straight tab</td> <td>heat boilers</td> </tr> <tr> <td>17.051.2</td> <td>230 V</td> <td>1500 W</td> <td>Cu / Ni</td> <td>340</td> <td>27</td> <td>8</td> <td>M14x1,5</td> <td>straight tab</td> <td>water heaters</td> </tr> <tr> <td>18.031</td> <td>230 V</td> <td>2000 W</td> <td>Cu / Ni</td> <td>490</td> <td>50</td> <td>8</td> <td>M14x1,5</td> <td>straight tab</td> <td>water heaters</td> </tr> </tbody> </table>	Type	Voltage	Wattage	Tubing type	Dimension [mm]		Ø [mm]	Thread	Electrical connection	Application	A	B	12.182	230 V	1400 W	Cu / Ni.	410	37	8,5	M14x1,5	straight tab	water heaters	12.101	230 V	1000 W	Cu / Ni	290	72	8,5	M14x1,5	straight tab	water heaters	17.341	230 V	2000 W	Cu / Ni	400	56	8	M14x1,5	straight tab	heat boilers	17.051.2	230 V	1500 W	Cu / Ni	340	27	8	M14x1,5	straight tab	water heaters	18.031	230 V	2000 W	Cu / Ni	490	50	8	M14x1,5	straight tab	water heaters
Type	Voltage					Wattage	Tubing type					Dimension [mm]		Ø [mm]	Thread	Electrical connection	Application																																														
		A	B																																																												
12.182	230 V	1400 W	Cu / Ni.	410	37	8,5	M14x1,5	straight tab	water heaters																																																						
12.101	230 V	1000 W	Cu / Ni	290	72	8,5	M14x1,5	straight tab	water heaters																																																						
17.341	230 V	2000 W	Cu / Ni	400	56	8	M14x1,5	straight tab	heat boilers																																																						
17.051.2	230 V	1500 W	Cu / Ni	340	27	8	M14x1,5	straight tab	water heaters																																																						
18.031	230 V	2000 W	Cu / Ni	490	50	8	M14x1,5	straight tab	water heaters																																																						

	<table border="1"> <thead> <tr> <th rowspan="2">Type</th> <th rowspan="2">Voltage</th> <th rowspan="2">Wattage</th> <th rowspan="2">Tubing type</th> <th colspan="2">Dimension [mm]</th> <th rowspan="2">Ø [mm]</th> <th rowspan="2">Thread</th> <th rowspan="2">Electrical connection</th> <th rowspan="2">Application</th> </tr> <tr> <th>A</th> <th>B</th> </tr> </thead> <tbody> <tr> <td>12.311</td> <td>230 V</td> <td>2000 W</td> <td>Cu / Ni.</td> <td>340</td> <td>72</td> <td>8,5</td> <td>M14x1,5</td> <td>straight tab</td> <td>water heaters</td> </tr> </tbody> </table>	Type	Voltage	Wattage	Tubing type	Dimension [mm]		Ø [mm]	Thread	Electrical connection	Application	A	B	12.311	230 V	2000 W	Cu / Ni.	340	72	8,5	M14x1,5	straight tab	water heaters
Type	Voltage					Wattage	Tubing type					Dimension [mm]		Ø [mm]	Thread	Electrical connection	Application						
		A	B																				
12.311	230 V	2000 W	Cu / Ni.	340	72	8,5	M14x1,5	straight tab	water heaters														

**HIGH POWER HEATING UNITS**

Heating units are composed of three tubular elements soldered into the head with 2" or 2 1/2" thread. The head may be finished with a box made of ABS or aluminum, which ensures IP 65 protection. Control of the heated medium's temperature is ensured by a liquid or digital thermostat placed in the box. It is also possible to deliver a heating unit with the embedded PT100 temperature sensor, which ensures simple connection of the heating element to the external power and control system.

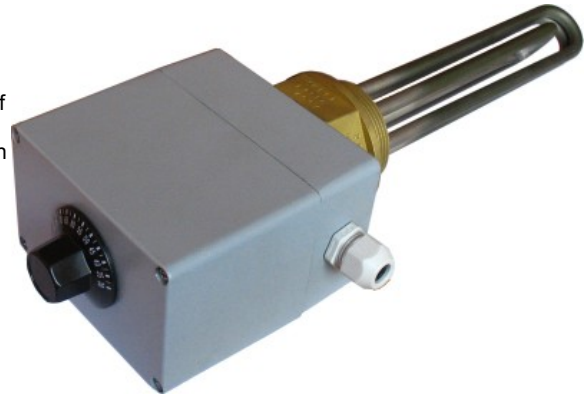

**CHARACTERISTICS:**

- rated wattage: up to 24 kW
- power supply: three-phase 400V~ (in the case of 3kW and 4.5kW units, optional single-phase 230V~ connection)
- Heating element material: stainless steel AISI 316L (SDW), stainless steel AISI 304 (SDO)
- head material: brass or stainless steel
- box made of aluminium or ABS - IP65 protection level
- surface load: 8,3 W/cm<sup>2</sup> lub 3 W/cm<sup>2</sup>

SDW heating elements for water and water solution heating, surface load of ~8.3 W/cm <sup>2</sup>								
Wattage	3 kW	4,5 kW	6 kW	9 kW	12 kW	15 kW	18 kW	24 kW
Ø of heater	8,5 mm	8,5 mm	8,5 mm	8,5 mm	8,5 mm	10,0 mm	10,0 mm	13,0 mm
Thread	2"	2"	2"	2"	2"	2 1/2"	2 1/2"	2 1/2"
Lmax	280 mm	390 mm	510 mm	740 mm	980mm	1050 mm	1250 mm	
Lm	30 mm	30 mm	30 mm	30 mm	30 mm	30 mm	30 mm	
SDO heating elements for oil, water and water solution heating, surface load of ~3 W/cm <sup>2</sup>								
Wattage	3 kW	4,5 kW	6 kW	9 kW	12 kW			
Ø of heater	8,5 mm	8,5 mm	8,5 mm	10,0 mm	13 mm			
Thread	2"	2"	2"	2 1/2"	2 1/2"			
Lmax	690 mm	1050 mm	1350 mm	1580 mm				
Lm	30 mm	30 mm	30 mm	30 mm				



**FLANGE IMMERSION HEATERS**





## Heating elements with controls for water heaters

### IMMERSION HEATERS WITH A CONTROLLER

Mounted immersion heaters are electric heating devices used to heat up water in open and closed tanks. The heaters may be installed only in a configuration where they are at all times below the surface level.

- The heaters are made of tubular heating elements supplied with single-phase 230V current;
- The infinite variable temperature regulator with non-automatic temperature limiter protects the heater against overheating;
- The temperature regulator knob and the signal lamp are set in the casing;
- Threaded terminal G1¼" or G1½";
- Protection level IP 44;
- Power connection: 3-core cable with a plug;

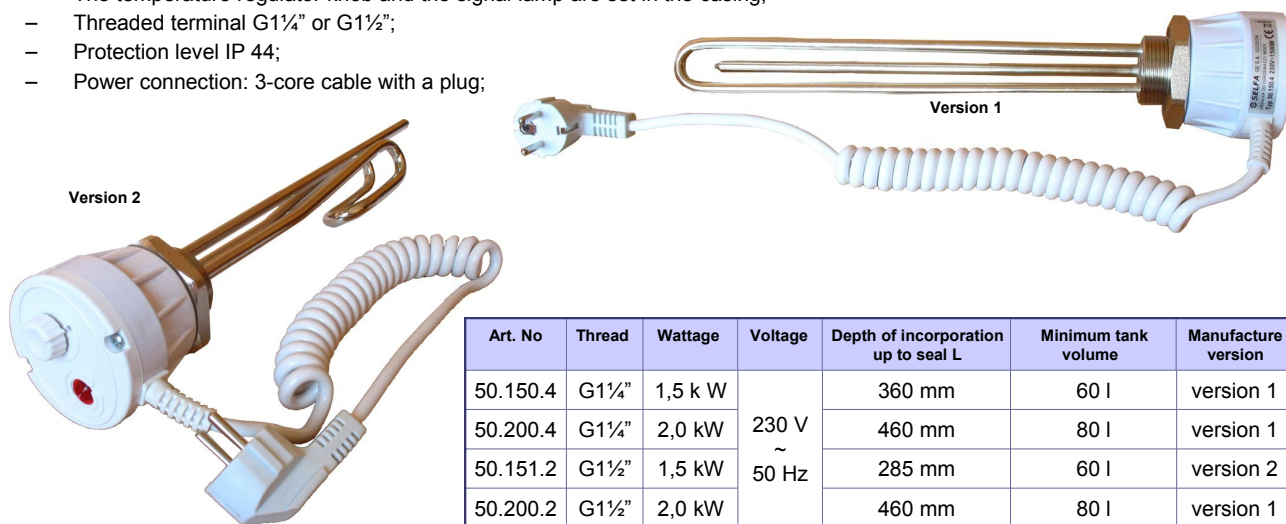

### INSULATED HEATING ELEMENTS WITH A THERMOSTAT

EJK heaters are used to heat up water in open and closed metal tanks, in particular enameled hot utility water tanks

- Heating elements are insulated by enclosing them in the casing entirely made of plastic, including the threaded part.
- For partial connection of the heating elements with the tank, a neutral earthing resistor is used with the appropriate resistance, which incorporates the elements into the anti-corrosion cathodic protection system for the tank. The solution provides optimum protection to the electric heater in the enameled tank against accelerated electrochemical corrosion, while maintaining the cathodic protection for the tank and the life span of the magnesium anode.
- Temperature control: from 5 to 70°C.
- The automatic disconnection of the heating unit is controlled by the temperature controller, and in the case it is damaged, by the non-automatic temperature limiter activated at the water temperature of 90°C.
- The freezing protection function to keep the water temperature in the tank at +5°C.
- The activation of the device is indicated by the green lamp. The flow of current through the heating element is indicated by the red lamp.
- Protection level: IP44
- Threaded terminal: 1 ½ "
- Maximum permitted pressure in the tank: 10 bar

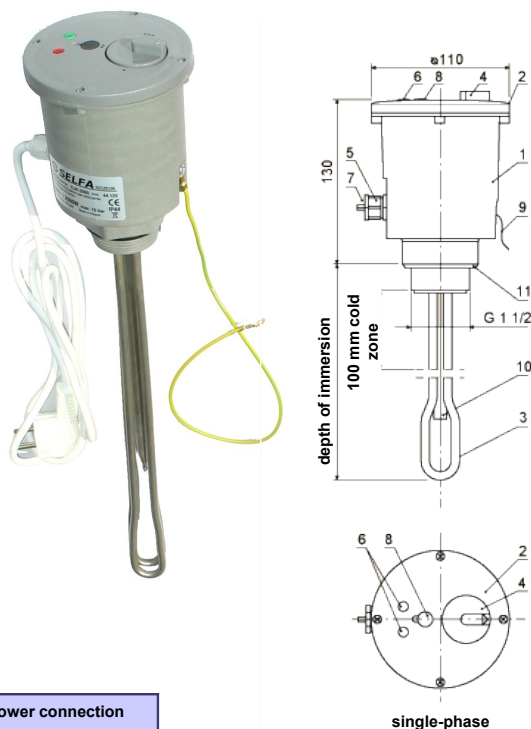

Art. No	Type	Wattage	Voltage	Depth of mounting to seal L	Minimum tank volume	Power connection
44.115	EJK-1500	1,5 k W	230 V	350 mm	60 l	3-core, 1.5m cable with a plug
44.120	EJK-2000	2,0 kW	230 V	350 mm	80 l	
44.130	EJK-3000	3,0 kW	3~ 400 V	290 mm	80 l	5-core, 1.5 m cable without a plug
44.145	EJK-4500	4,5 kW	3~ 400 V	390 mm	100 l	
44.160	EJK-6000	6,0 kW	3~ 400 V	500 mm	100 l	
44.190	EJK-9000	9,0 kW	3~ 400 V	720 mm	250 l	

- 1 - body
- 2 - cover
- 3 - heating element
- 4 - temperature controller knob
- 5 - gland
- 6 - signal lamps
- 7 - power cord
- 8 - plug for STB activation
- 9 - earth lead
- 10 - capillary sensor protective tube
- 11 - seal

## HEATING ELEMENTS WITH ELECTRONIC THERMOSTAT

Characteristics:

- user friendly, modern touch control
- 3 levels of temperature setting
- 2h timer
- intelligent work control (failure signaling, open water circuit signaling, frost protection mode)
- heater mounting by threaded 1/2" connector with a seal

Type	Voltage	Wattage
50.243	230 V	300 W
50.246	230 V	600 W
50.249	230 V	900 W

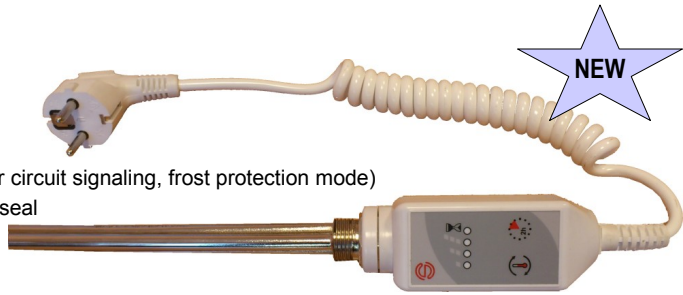

## HEATING ELEMENTS WITH TEMPERATURE LIMITERS

**Insulation class 1 heating element** with a 1/2" head to work with ladder type radiators.

Characteristics:

- automatic temperature limiter disconnecting the heater at 90°C
- thermal fuse (one-time), disconnecting at 157°C
- protection level IP57
- heater mounting by a threaded 1/2" connector with a seal
- connection to the power network by spiral 3x75mm<sup>2</sup> cable

Type	Voltage	Wattage	Length L
50.223	230 V	300 W	300 mm
50.226	230 V	600 W	380 mm
50.229	230 V	900 W	420 mm



**Insulation class 2 heating element** with a 1/2" head to work with ladder type radiators. The heater can be used for towel rail radiators, where class 2 insulation is required.

Type	Voltage	Wattage	Length L
50.233	230 V	300 W	400 mm

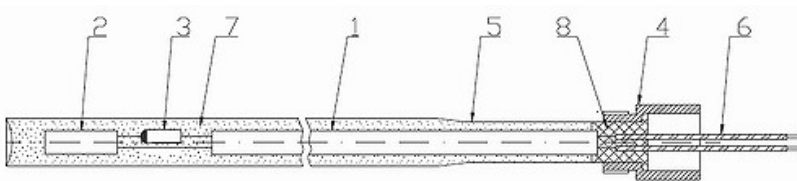
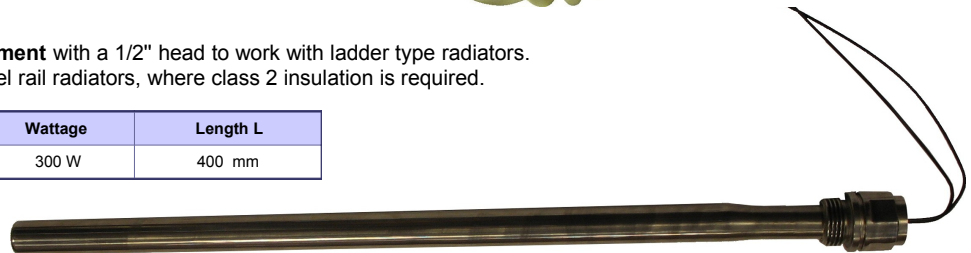

1. Heating element in standard insulation
2. Automatic temperature limiter
3. Thermal fuse
4. Stainless steel mounting head G 1/2"
6. Connection cables
7. Extra insulation
8. Sealing

## Magnesium anodes

Water heater anode rods are generally screwed into the top of the tank in order to protect them against chemical corrosion

Because the rod is made with a higher current potential than other metals in the water heater, it will ensure that the galvanic current flows from the rod to other exposed metals, preventing their corrosion. In other words, the anode rod corrodes and not the tank or the element. The anode rod is "self-sacrificing."

When there's no sacrificial metal left on the anode, the tank can rust out.

Diameter [mm]	Length [mm]	Mounting (thread x length.) [mm]
ø21,3	300	M8 x 30
ø21,3	420	M8 x 25
ø21,3	550	M8 x 30
ø21,3	280	M8 x 15
ø21,3	320	M8 x 25
ø33	270	M8 x 30



### Heating elements for tea kettles and immersion heaters

Type	Voltage	Wattage	Tube type	Dimension[mm]		Ø [mm]	Application
				A	B		
12.304	230 V	1000 W	Cu / Ni	100	90	8,5	porcelite tea kettle



Type	Voltage	Wattage	Tube type	Dimension[mm]		Ø [mm]	Application
				A	B		
18.181	230 V	1000 W	Cu / Ni	60	60	8	prot. STRIX (MINI)

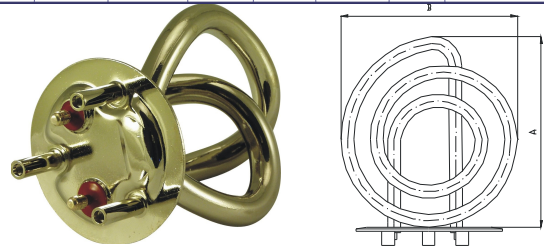

Type	Voltage	Wattage	Tube type	Dimension[mm]		Ø [mm]	Application
				A	B		
18.111	230 V	2000 W	Cu / Ni	85	80	8	prot. STRIX, ZELMER
18.111 OTTER	230 V	2000 W	Cu / Ni	85	80	8	prot. OTTER, MOULINEX

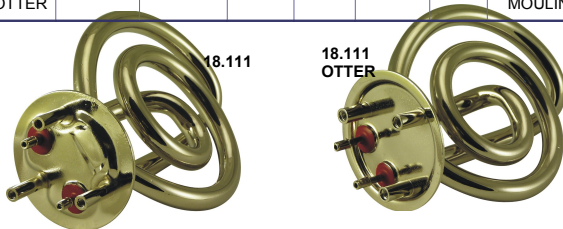

Type	Voltage	Wattage	Tube type	Dimension [mm]		Connection
				L	Ø	
50.101	230 V	1600 W	Cu / Ni	345	150	3-core cable with a plug

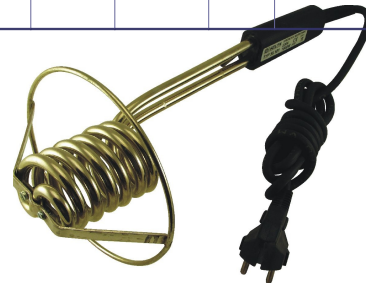

### Heating elements for water stills

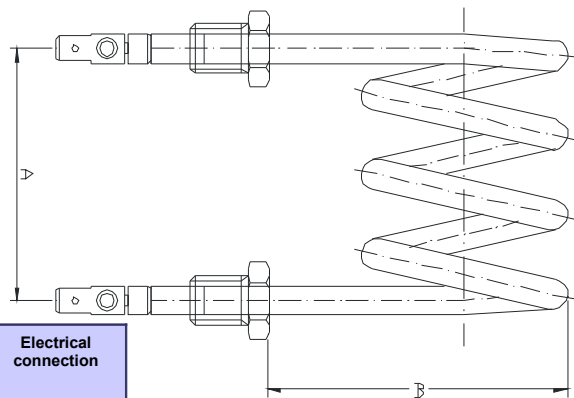
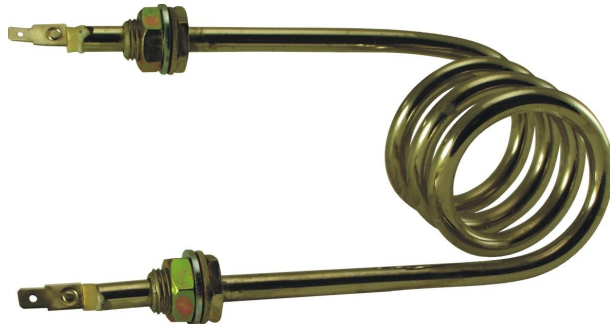

Type	Voltage	Wattage	Tubing type	Dimension [mm]		Ø [mm]	Thread	Electrical connection
				A	B			
18.161	230 V	1200 W	Cu / Ni	56	134	8	M14x1,5	straight tab

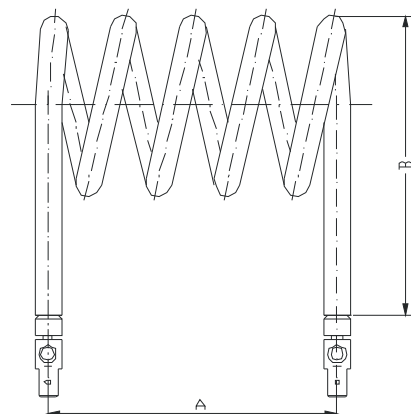

Type	Voltage	Wattage	Tubing type	Dimension [mm]		Ø [mm]	Electrical connection
				A	B		
12.023	230 V	1400 W	Cu / Ni	100	110	8,5	straight tab
18.091	230 V	2000 W	Cu / Ni	56	95	8	
16.071	230 V	1200 W	Cu / Ni	100	95	8,5	
16.072	230V	1200 W	Cu	100	95	8,5	pin
16.091	230 V	1400 W	Cu / Ni	60	155	8,5	straight tab
16.101	230 V	1300 W	Cu / Ni	100	95	8,5	

**Heating elements for oil heaters**

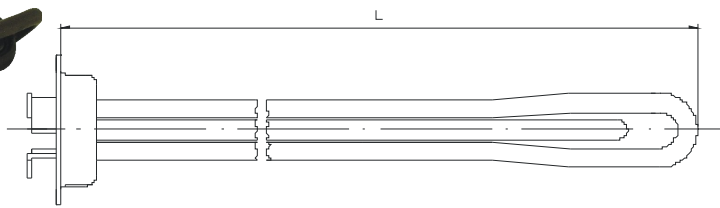
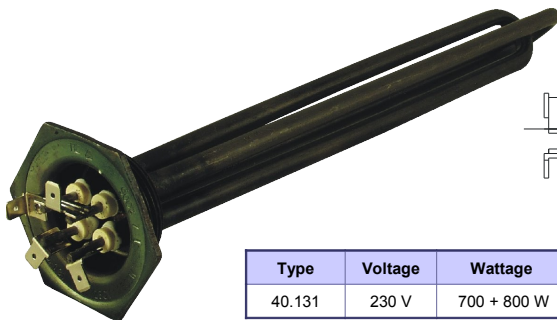

Type	Voltage	Wattage	Tubing type	Dimension L	Ø [mm]	Thread <sup>(*)</sup>	Electrical connection
40.131	230 V	700 + 800 W	stainless steel	330 mm	8,5	G 1 1/4 "	angular tab

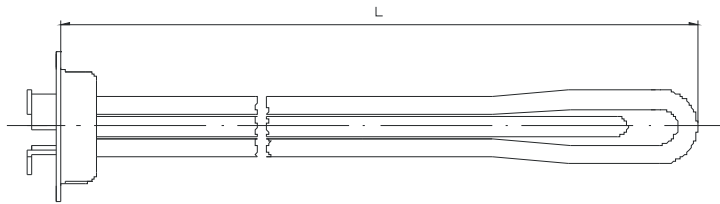
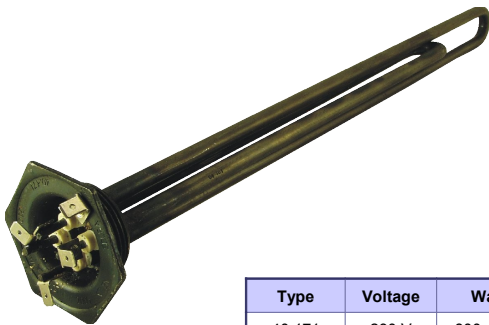

Type	Voltage	Wattage	Tubing type	Dimension L	Ø [mm]	Thread <sup>(*)</sup>	Electrical connection
40.171	230 V	800 + 1200 W	stainless steel	430 mm	8,5	G 1 1/4 "	angular tab

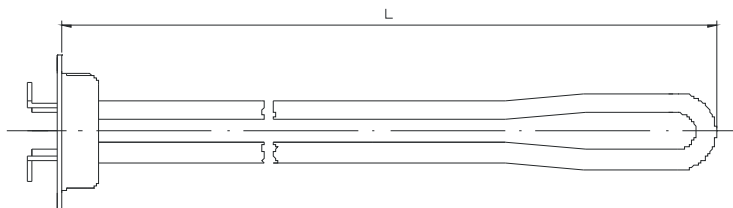
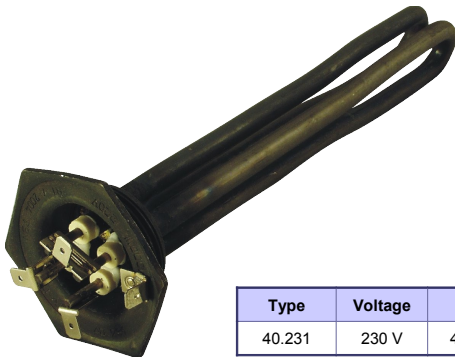

Type	Voltage	Wattage	Tubing type	Dimension L	Ø [mm]	Thread <sup>(*)</sup>	Electrical connection
40.231	230 V	400 + 600 W	stainless steel	225 mm	8,5	G 1 1/4 "	angular tab

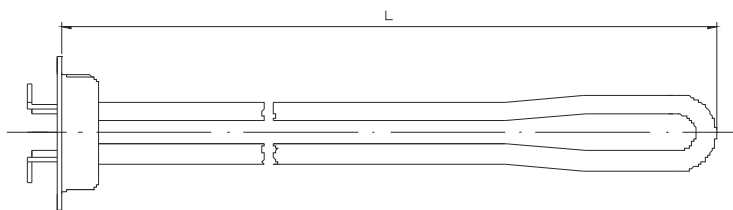
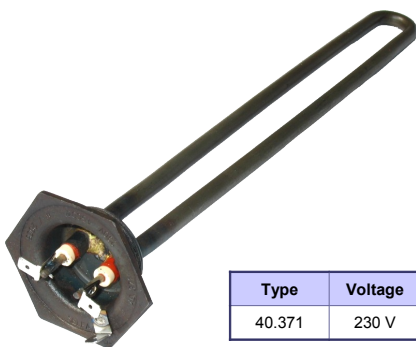

Type	Voltage	Wattage	Tubing type	Dimension L	Ø [mm]	Thread <sup>(*)</sup>	Electrical connection
40.371	230 V	1500 W	stainless steel	330	8,5	G 1 1/4 "	angular tab

<sup>(\*)</sup> formed head made from unalloyed steel



## Heating elements to work in the air - various applications

Type	Voltage	Wattage	Tube type	Dimension [mm]		Ø [mm]
				A	B	
01.122	230 V	800 W	Cr/Ni	545	36	6,4
02.042	230 V	2000 W	Cr/Ni	770	120	8,5
02.052	230 V	2500 W	Cr/Ni	1030	120	8,5
02.082	230 V	1000 W	Cr/Ni	370	56	8,5
02.091	230 V	600 W	Cr/Ni	520	56	8,5
02.191	230 V	700 W	Cr/Ni	350	50	8,5
02.111	230 V	900 W	Cr/Ni	790	56	8,5
02.211	230 V	500 W	Cr/Ni	390	140	8,5
02.221	230 V	630 W	Cr/Ni	345	50	8,5
02.231	230 V	800 W	Cr/Ni	375	140	8,5
02.241	230 V	1000 W	Cr/Ni	685	32	8,5
02.271	230 V	500 W	Cr/Ni	590	60	8,5
02.611	230 V	900 W	Cr/Ni	450	53	8,5
02.621	230 V	600 W	Cr/Ni	480	33	8,5
02.631	230 V	800 W	Cr/Ni	520	42	8,5
02.641	230 V	800 W	Cr/Ni	630	42	8,5
03.261	230 V	2500 W	Cr/Ni	1225	110	10,0
03.311	230 V	1200 W	Cr/Ni	630	56	10,0

Electrical connection: straight tab

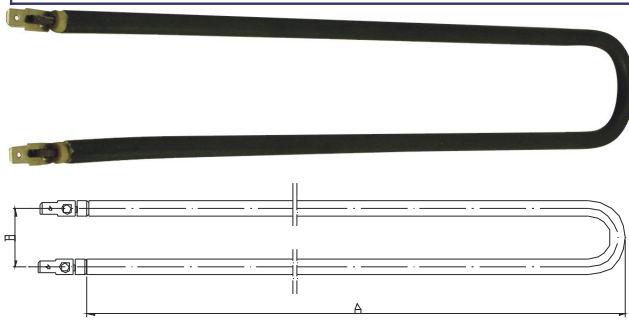

Type	Voltage	Wattage	Tube type	Dimension L [mm]	Ø [mm]
01.092	230 V	320 W	Cr/Ni	1110	6,4
01.123	230 V	800 W	Cr/Ni	1110	6,4
01.241	230 V	1000 W	Cr/Ni	1055	6,4
02.042	230 V	2000 W	Cr/Ni	1600	8,5
02.082	230 V	1000 W	Cr/Ni	770	8,5
02.211	230 V	500 W	Cr/Ni	850	8,5
02.221	230 V	630 W	Cr/Ni	710	8,5
02.231	230 V	800 W	Cr/Ni	850	8,5
02.241	230 V	1000 W	Cr/Ni	1380	8,5
02.251	230 V	2000 W	Cr/Ni	1750	8,5
02.521	230 V	1500 W	Cr/Ni	1610	8,5
03.261	230 V	2500 W	Cr/Ni	2500	10,0
03.271	230 V	1500 W	Cr/Ni	1700	10,0

Mark STRAIGHT VERSION on the order  
Electrical connection: straight tab

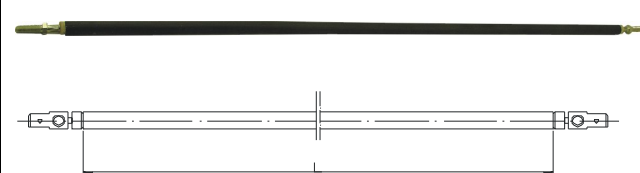

Type	Voltage	Wattage	Tube type	Dimension [mm]		Ø [mm]
				A	B	
K 273	230 V	1000 W	Cr/Ni	480	61	6,4
K 274	230 V	1200 W	Cr/Ni	690	61	8,5
K 275	230 V	1800 W	Cr/Ni	980	61	8,5
02.181	230 V	1750 W	Cr/Ni	1090	56	8,5

Electrical connection: M4 threaded clamp  
Mounting: M14x1.5 threaded stub

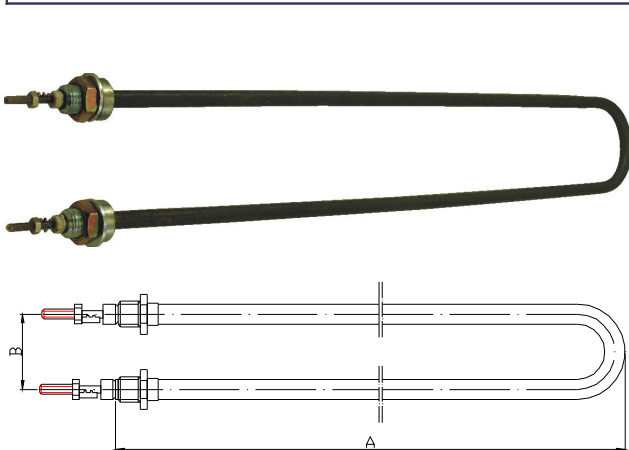

**Bendable (for shaping) heating elements to work in air**

Type	Voltage	Wattage	Surface load [W/cm <sup>2</sup> ]	Length L [mm]	Cold zones	Ø [mm]
01.121	230 V	800 W	4,3	1110	2 x 80 mm	6,4
01.881	230 V	1000 W	4,8	1200	2 x 80 mm	6,4
01.891	230 V	1500 W	5,2	1600	2 x 80 mm	6,4
01.901	230 V	2000 W	6,1	1800	2 x 80 mm	6,4

Electrical connection: straight tab  
Mounting: M10x1 threaded stub  
Tube material: stainless steel

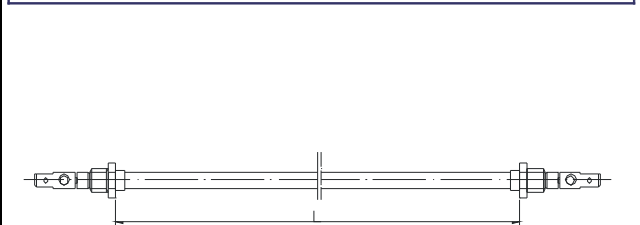

**Heating elements for electric cookers**

Type	Voltage	Wattage	Tube type	Dimension [mm]		Ø [mm]	Application
				A	B		
01.431	230 V	2000 W	Cr / Ni	375	186	6,4	WROZAMET
02.391	230 V	2000 W	Cr / Ni	375	186	8,5	WROZAMET
01.921	230 V	1100 W	Cr / Ni	390	200	6,4	BEKO

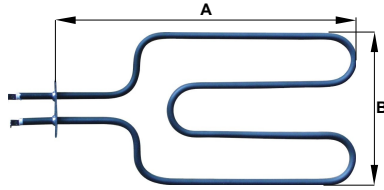

Type	Voltage	Wattage	Tube type	Dimension [mm]		Ø [mm]	Application
				A	B		
01.651	230 V	2000 W	Cr / Ni	335	250	6,4	WROZAMET
21.111.2	230 V	1500 W	Cr / Ni	335	250	6,4	

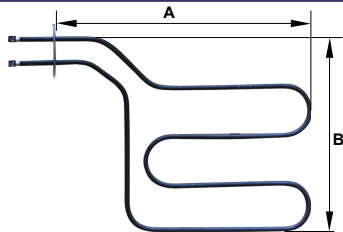

Type	Voltage	Wattage	Tube type	Dimension [mm]		Ø [mm]	Application
				A	B		
01.691	230 V	1300 W	Cr / Ni	412	230	6,4	WROZAMET
01.691.2	230 V	1300 W	Cr / Ni	412	230	6,4	AMICA without mounting screw

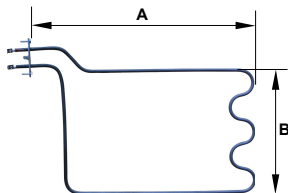

Type	Voltage	Wattage	Tube type	Dimension [mm]		Ø [mm]	Application
				A	B		
21.141	230 V	1300 W	Cr / Ni	360	348	6,4	AMICA

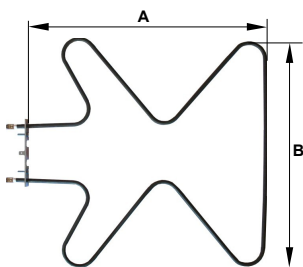

Type	Voltage	Wattage	Tube type	Dimension [mm]		Ø [mm]	Application
				A	B		
21.131	230 V	600 W	Cr / Ni	298	132	6,4	

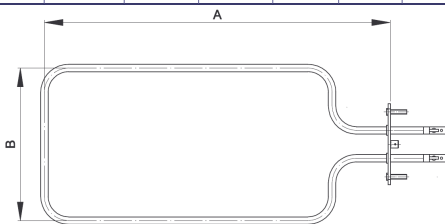

Type	Voltage	Wattage	Tube type	Dimension [mm]		Ø [mm]	Application
				A	B		
01.014	230 V	1200 W	Cr / Ni	365	330	6,4	
01.804	230 V	1500 W	Cr / Ni	365	330	6,4	

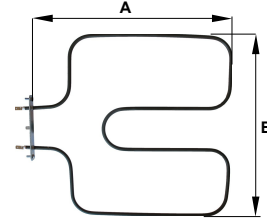

Type	Voltage	Wattage	Tube type	Dimension [mm]		Ø [mm]	Application
				A	B		
01.701	230 V	700 W	Cr / Ni	352	224	6,4	WROZAMET

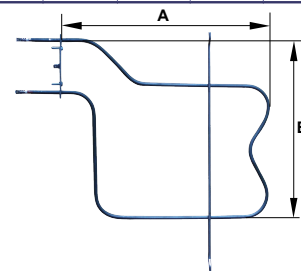

Type	Voltage	Wattage	Tube type	Dimension [mm]		Ø [mm]	Application
				A	B		
01.591	230 V	1600 W	Cr / Ni	360	346	6,4	ARDO

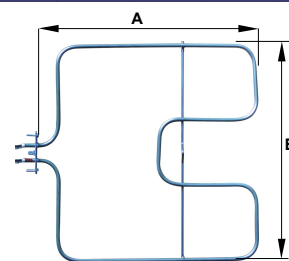

Type	Voltage	Wattage	Tube type	Dimension [mm]		Ø [mm]	Application
				A	B		
40.271	230 V	1500W+800W	Cr / Ni	350	326	6,4	
40.211	230 V	1200W+800W	Cr/Ni	350	326	6,4	

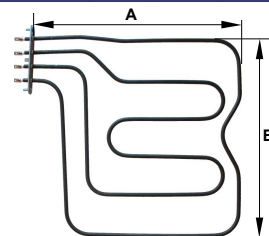

Type	Voltage	Wattage	Tube type	Dimension [mm]		Ø [mm]	Application
				A	B		
40.201	230 V	800W + 400W	Cr / Ni	337	188	6,4	

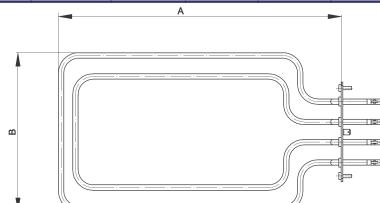

Type	Voltage	Wattage	Tube type	Dimension [mm]		Ø [mm]	Application
				A	B		
21.101.2	230 V	800 W	Cr / Ni	350	326	6,4	

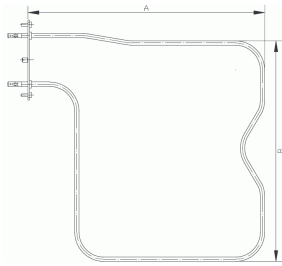

Type	Voltage	Wattage	Tube type	Dimension [mm]		Ø [mm]	Application
				A	B		
01.451	230 V	900 W	Cr / Ni	412	345	6,4	WROZAMET
01.461	230 V	1300 W	Cr / Ni	412	345	6,4	WROZAMET
01.491	230 V	1100 W	Cr / Ni	412	345	6,4	ŚWIATOWIT, WROZAMET
01.671	230 V	700 W	Cr / Ni	412	345	6,4	WROZAMET
01.681	230 V	1500 W	Cr / Ni	412	345	6,4	WROZAMET
02.301	230 V	1100 W	Cr / Ni	412	345	8,5	WROZAMET

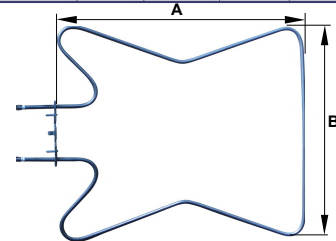

Type	Voltage	Wattage	Tube type	Dimension [mm]		Ø [mm]	Application
				A	B		
40.712	230 V	2400 W	Cr / Ni	532	434	8,5	

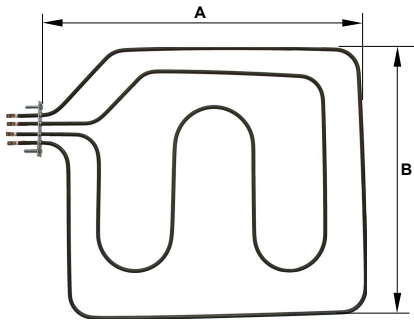

Type	Voltage	Wattage	Tube type	Dimension [mm]		Ø [mm]	Application
				A	B		
9267	400 V	3950 W	Cr / Ni	513	547	8,5	

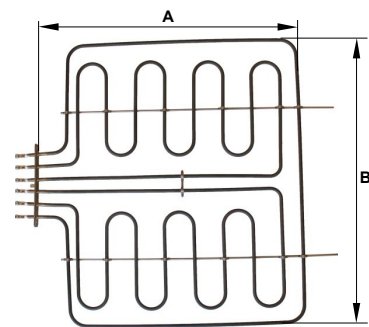

Type	Voltage	Wattage	Tube type	Dimension [mm]		Ø [mm]	Application
				A	B		
01.481	230 V	2000 W	Cr/Ni	262	193	6,4	WROZAMET
01.231	230 V	2000 W	Cr/Ni	240	190	6,4	AMICA

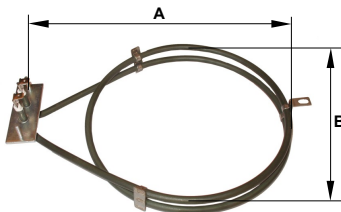

Type	Voltage	Wattage	Tube type	Dimension [mm]		Ø [mm]	Application
				A	B		
21.031	230 V	2400 W	Cr/Ni	250	191	6,4	BOSCH
21.041	230 V	3500 W	Cr/Ni	240	192	6,4	

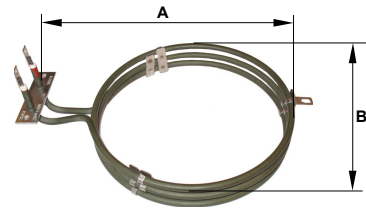

Type	Voltage	Wattage	Tube type	Dimension [mm]		Ø [mm]	Application
				A	D		
01.794	230 V	2000 W	Cr/Ni	202	Ø180	6,4	
21.181	230 V	2000 W	Cr/Ni	210	Ø180	6,4	ARDO

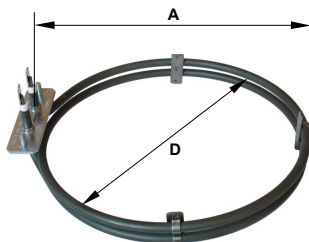

Type	Voltage	Wattage	Diameter [mm]
Heating plate GOWI-0020	230 V	1000 W	Ø 145
Heating plate GOWI-0023	230 V	1500 W	Ø 145
Heating plate GOWI-0021	230 V	1500 w	Ø 180
Heating plate GOWI-0022	230 V	2000 w	Ø 180



## Heating elements for electric cookers

Type	Voltage	Wattage	Tube type	Dimension [mm]		Ø [mm]
				A	B	
01.021	230 V	800 W	Cr / Ni	139	139	6,4
01.071	110 V	1000 W	Cr / Ni	139	139	6,4
5046	48 V	600 W	Cr / Ni	139	139	6,4
A0530	70 V	1000 W	Cr / Ni	139	139	6,4
7119	60 V	1000 W	Cr / Ni	139	139	6,4
7120	170 V	1000 W	Cr / Ni	139	139	6,4
6992	75 V	1000 W	Cr / Ni	139	139	6,4

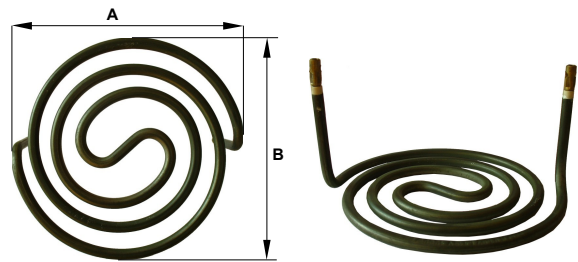

## Heating elements to work in the air with ventilation

Type	Voltage	Wattage	Tube type	Dimension [mm]		Ø [mm]
				A	B	
01.751	230 V	830 W	stainl. steel	195	220	6,4
01.761	230 V	1500 W	stainl. steel	250	290	6,4

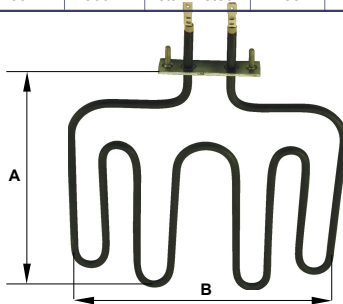

Type	Voltage	Wattage	Tube type	Dimension [mm]		Ø [mm]
				A	B	
01.631	230 V	800 W	stainl. steel	155	173	6,4
01.631.2	230V	1000 W	stainl. steel	155	173	6,4

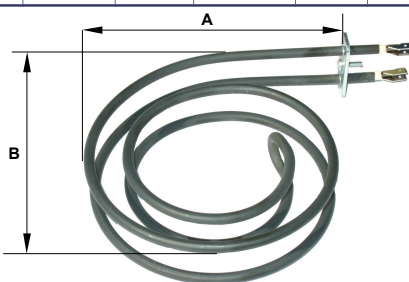

Type	Voltage	Wattage	Tube type	Dimension [mm]		Ø [mm]
				A	B	
P-610	220 V	1500 W	stainl. steel	175	135	8,5
P-611	220 V	2000 W	stainl. steel	183	162	6,4
P-612	220 V	1500 W	stainl. steel	183	164	8,5
P-614	220 V	3000 W	stainl. steel	220	193	6,4
P-615	220 V	2000 W	stainl. steel	225	195	8,5
P-616	220 V	3000 W	stainl. steel	225	195	8,5
P-618	380 V	2000 W	stainl. steel	183	162	6,4
P-619	380 V	2000 W	stainl. steel	183	164	8,5
P-620	380 V	2500 W	stainl. steel	220	200	6,4
P-621	380 V	2000 W	stainl. steel	225	195	8,5
P-622	380 V	2500 W	stainl. steel	225	195	8,5

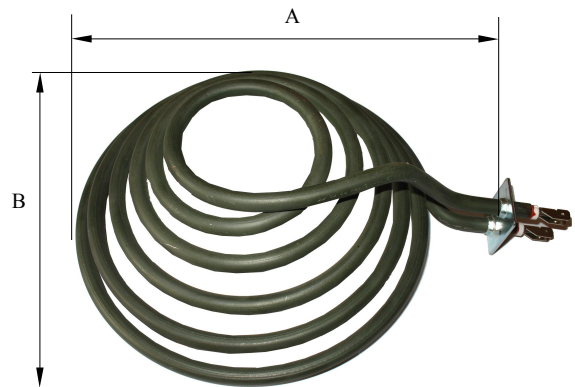

Type	Voltage	Wattage	Tube type	Dimension [mm]		Ø [mm]
				A	B	
P-608	220 V	1000 W	stainl. steel	140	124	6,4
P-609	220 V	1500 W	stainl. steel	140	124	6,4
P-613	220 V	2000 W	stainl. steel	210	144	8,5
P-617	220 V	4000 W	stainl. steel	302	257	8,5
P-693	220 V	4000 W	stainl. steel	320	257	8,5

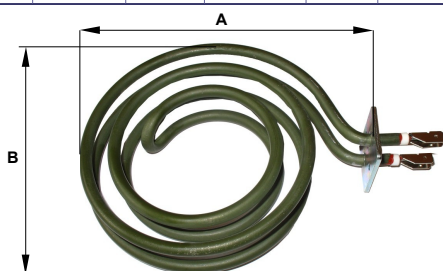

Type	Voltage	Wattage	Tube type	Dimension [mm]		Ø [mm]
				A	B	
P-605	220 V	600 W	stainl. steel	75	58	6,4
P-606	220 V	800 W	stainl. steel	95	80	6,4
P-607	220 V	1000 W	stainl. steel	105	92	6,4
P-346	400 V	1000 W	stainl. steel	145	113	6,4

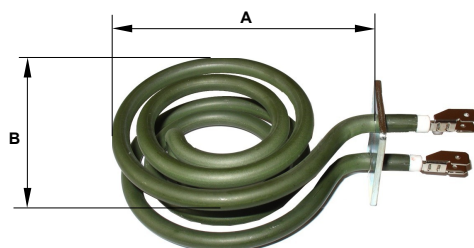



**Heating elements for catering and diners, for packaging machines, for saunas**

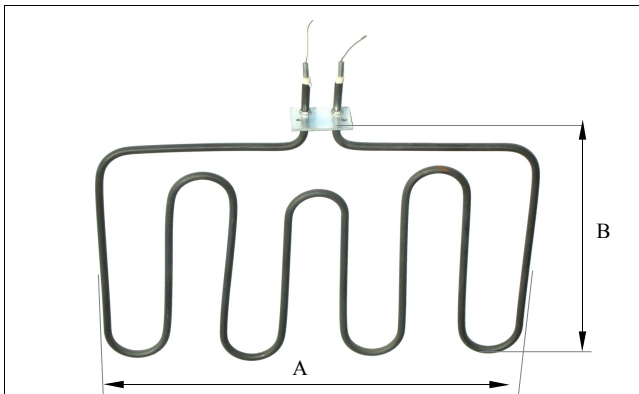

Type	Voltage	Wattage	Tube type	Dimension [mm]		Ø [mm]
				A	B	
01.291	230 V	1500 W	stainl. steel	350	261	6,9

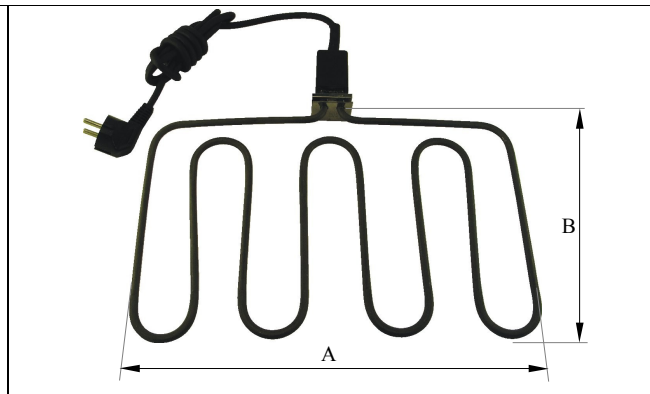

Type	Voltage	Wattage	Tube type	Dimension [mm]		Ø [mm]
				A	B	
01.471	230 V	2000 W	stainl. steel	350	262	6,9

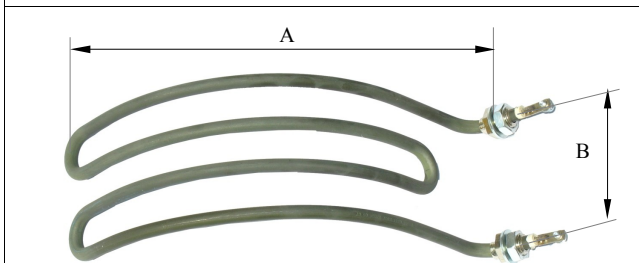

**KEBAB HEATER**

Type	Voltage	Wattage	Mounting	Dimension [mm]		Ø [mm]
				A	B	
K 038	230 V	1300 W	M14x1,5	265	80	8,5

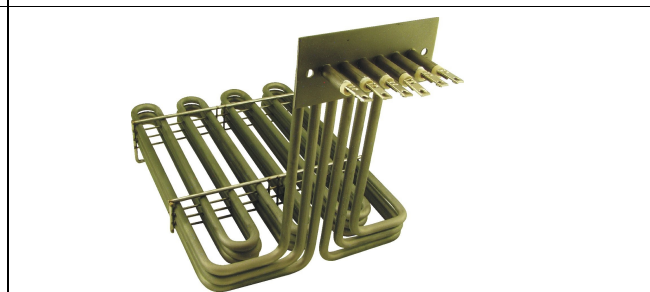

**HEATING UNIT FOR DEEP FRYERS**

Type	Voltage	Wattage	Tube type
9306	230 V	3 x 2000 W	stainless steel

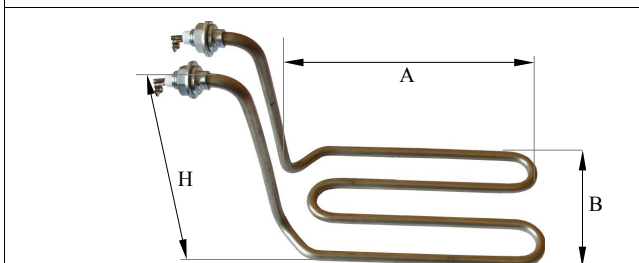

**HEATING ELEMENT FOR DEEP FRYERS**

Type	Voltage	Wattage	Dimension [mm]			Tube type
			A	B	H	
22.681	230 V	2600 W	212	110	165	stainl. steel
22.691	230 V	3200 W	212	110	190	stainl. steel

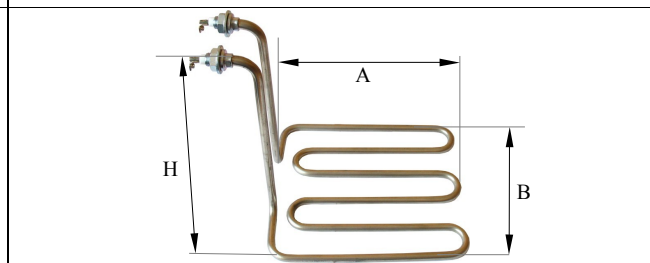

**HEATING ELEMENT FOR DEEP FRYERS**

Type	Voltage	Wattage	Dimension [mm]			Tube type
			A	B	H	
22.701	230 V	3200 W	211	178	215	stainl. steel
22.711	230 V	3200 W	211	178	165	stainl. steel



**HEATING ELEMENT FOR AIR-TIGHT PACKAGING MACHINES**

Type	Voltage	Wattage	Outside diameter	Ø [mm]
K 088	230 V	400 W	Ø 88 [mm]	8,5
K 230	230 V	550 W	Ø 85 [mm]	6,4



**CHARCOAL IGNITER**

Type	Voltage	Wattage	Tube type	Cord length
61.103	230 V	800 W	stainl. steel	1500mm

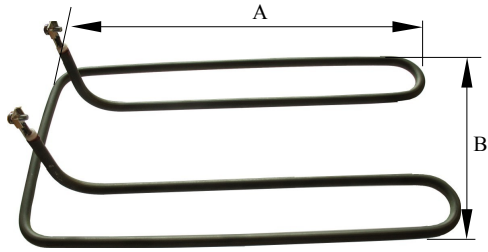

**SMALL CATERING**

Type	Voltage	Wattage	Tubing type	Dimension [mm]		Ø [mm]	Work environment
				A	B		
22.161	230 V	1750 W	Ni-Cr	374	248	8,5	air
22.171	230 V	1250 W	Ni-Cr	325	184	8,5	air

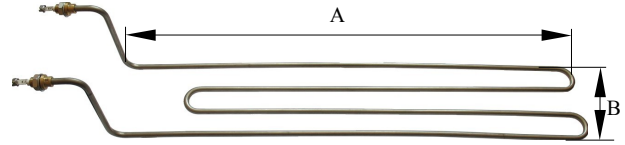

**FRYERS**

Type	Voltage	Wattage	Tubing type	Dimension [mm]		Ø [mm]	Work environment
				A	B		
K130	230 V	2800 W	Ni-Cr	730	120	8,5	oil

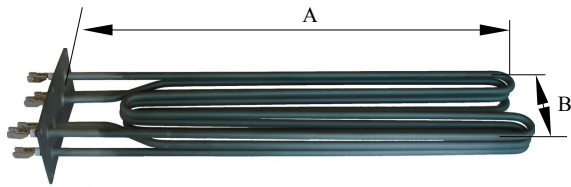

**SMALL CATERING**

Type	Voltage	Wattage	Tubing type	Dimension [mm]		Ø [mm]	Work environment
				A	B		
40.141	3 x 230 V	3 x 3 kW	Ni-Cr	382	76	8,5	water

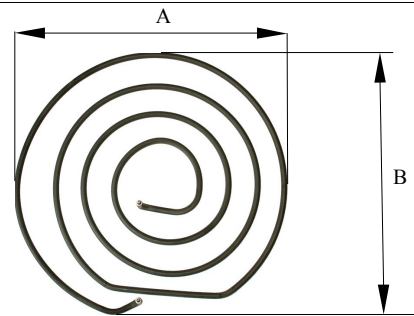

**PANCAKES MACHINES**

Type	Voltage	Wattage	Tubing type	Dimension [mm]		Ø [mm]
				A	B	
A2922	230 V	3000 W	Ni-Cr	388	385	8,5

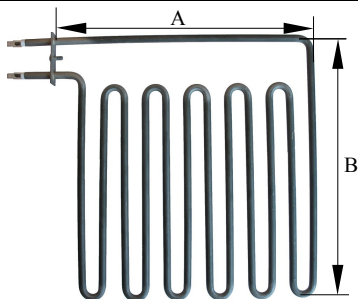

**HEATING ELEMENT FOR SAUNA**

Type	Voltage	Wattage	Dimension [mm]		Ø [mm]
			A	B	
A2283	230 V	1750 W	340	305	8,5

*Other wattages for sauna heating elements are also available on request*

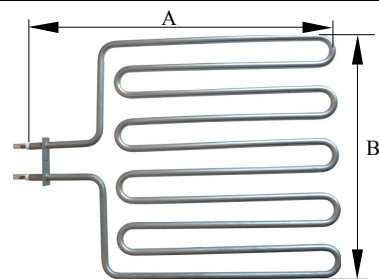

**HEATING ELEMENT FOR SAUNA**

Type	Voltage	Wattage	Dimension [mm]		Ø [mm]
			A	B	
A0033	230 V	2500 W	385	302	8,5
A0032	230 V	2000 W	385	302	8,5
A2334	230 V	2670 W	385	302	8,5

## Finned tubular heating elements

High emission surface heating elements that enable a significant increase in the heat stream and heating element power consumption efficiency.

### Application

- heating elements for food production and processing lines
- painting and varnish chambers
- heating tunnels in packaging machines
- A/C equipment
- air heaters, blowers, driers
- bakery equipment

Radiator as band wrapped around the heater axis				
Radiator material	stainless steel ①			aluminum ②
Heating element diameter	Ø 8.5	Ø 10	Ø 13	Ø 8.5
Heating element outer diameter	Ø 25	Ø 26	Ø 29	Ø 28.5
Maximum length of heating element	L = 3400 mm			L = 3400 mm
Tube material	stainless steel			
Maximum working temperature	400 °C			
Shape of heating element	straight or bend as agreed			straight

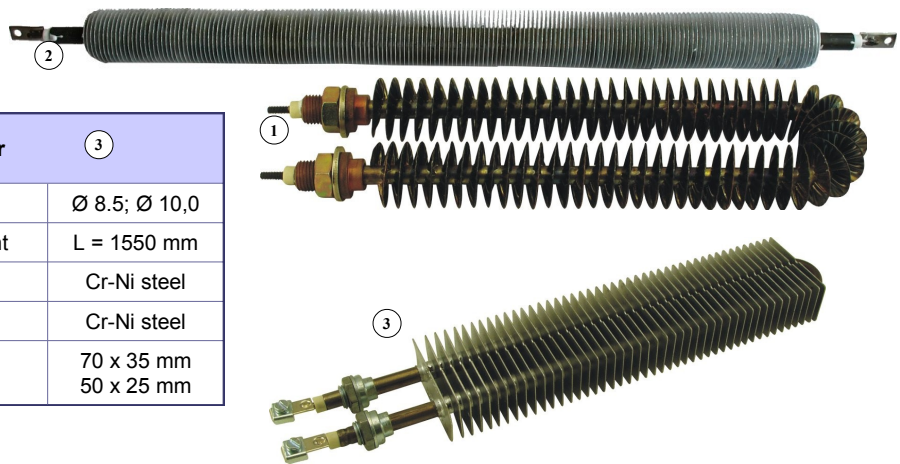

Finned radiator ③	
Heating element diameter	Ø 8.5; Ø 10,0
Maximum length of heating element	L = 1550 mm
Tube material	Cr-Ni steel
Radiator material	Cr-Ni steel
Radiator fin dimensions	70 x 35 mm 50 x 25 mm

## Radiator heaters for control cabinets

The heater is designed to be mounted inside control cabinets with electrical equipment in order to maintain the temperature required for the equipment to operate properly. The heating of the inside of outdoor cabinets prevents steam condensation and represents excellent protection against freezing as the temperature inside the cabinet is kept above dew point. Large surface of the radiator enables good heat transfer from the heating element to the inside of the cabinet.

Heaters for control cabinets					
Type	56.123	56.124	56.125	56.126	56.128
Supply voltage	230 V~	230 V~	230 V~	54 V=	115 – 230 V~
Wattage	100 W	60 W	250 W	250 W	max. 90 W
Dimensions (height x width x depth) [mm]	100 x 62 x 95	100 x 62 x 95	100 x 115 x 95	56 x 120 x 152	97 x 74 x 71
embedded automatic temperature limiter T <sub>max</sub> = 85 °C				temperature limiter (activated at 145°C)	with PTC heaters (self-regulation)
the package contains: two connectors to DIN 35 mm rail with a plug and a clip for DIN 35mm rail				mounted on DIN rail, fan enclosed	included connector to DIN 35mm rail

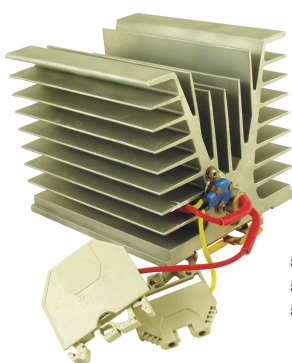

56.123  
56.124  
56.125



56.126



56.128

## Heating elements for refrigeration

Tubular heating elements designed to work in damp environments; their hermetic design prevents the ingress of moisture into the heater. Heater ends are vulcanized (coated with rubber under pressure), which ensures very tight connection between the cord and the heater.

- tube material: stainless steel AISI 316L
- length of cold parts:  $L_m = 80$  mm
- power cord:  $1 \times 1.5 \text{ mm}^2$ , rubber insulation 500 mm
- earth lead (special order)
- sheath diameter: 8,35 lub 8,5mm. Available also with diameter 6,4.

Type	Voltage	Wattage	Length L	Surface load
06.001	230 V	300 W	500 mm	3,3 W/cm <sup>2</sup>
06.011	230 V	250 W	600 mm	2,1 W/cm <sup>2</sup>
06.021	230 V	300 W	750 mm	2,0 W/cm <sup>2</sup>
06.031	230 V	350 W	1000 mm	1,6 W/cm <sup>2</sup>
06.041	230 V	400 W	1200 mm	1,4 W/cm <sup>2</sup>
06.051	230 V	450 W	1400 mm	1,4 W/cm <sup>2</sup>
06.061	230V	500 W	1700 mm	1,2 W/cm <sup>2</sup>
06.071	230 V	630 W	1700 mm	1,5 W/cm <sup>2</sup>
06.081	230 V	600 W	2100 mm	1,2 W/cm <sup>2</sup>
06.091	230 V	960 W	2600 mm	1,5 W/cm <sup>2</sup>

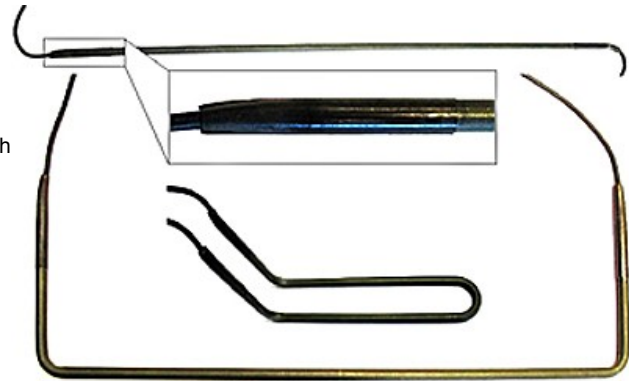
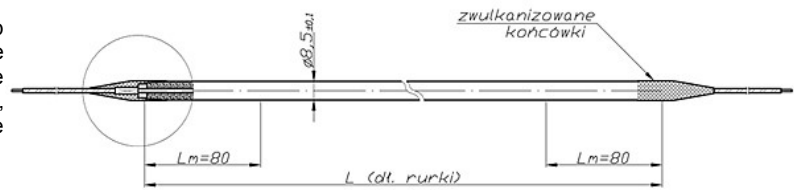

### Properties:

- hermetic, watertight design,
- corrosion resistant,
- working temperature:  $-40 \div 800^\circ$ ,
- low surface load,
- option to bend to any shapes

### Application:

It is used to defrost and thaw in such devices as: refrigerators, freezers, cold stores, defrosting rooms and compressors in the following industries: refrigeration, pharmaceutical, paper making.

## HEATING ELEMENTS FOR ABSORPTION REFRIGERATORS

Type	Voltage	Wattage	Length L	Diameter
62.210	230 V	85 W	100 mm	16 mm





## Cartridge heating elements

### CHARACTERISTICS

Cartridge heaters are special design, modern, highly efficient heating elements. Small dimensions combined with high heat capacity enable cartridge heaters to emit significant amounts of heat from a relatively small area.

One-sided power supply facilitates incorporation into a small working space, which also simplifies the power supply wiring. The application of top materials, stringent design and manufacture criteria, ensure high quality for most demanding applications.

Cartridge heaters enable a very good heat transfer, constant temperature and resistance to oxidation and corrosion, even at elevated temperatures.

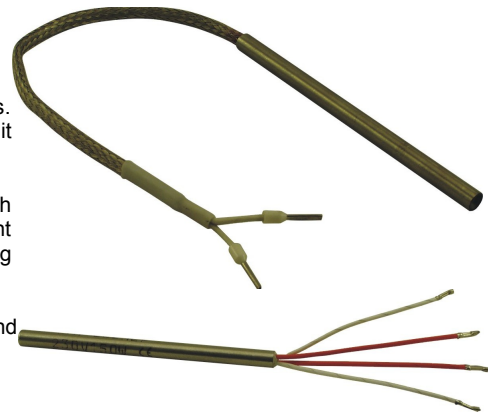

### STRUCTURE

**Resistance wire** (4), from nickel-chromium alloy is precisely coiled around a **ceramic core** (3), located centrally along the heater axis. Powdered **insulating material** (5), having specific grainage and purity, filling the space between the **metal sheath** (2) and the core, is compacted in the technology process which ensures high dielectric resistance and markedly improves the abstraction of the generated heat, allowing short heating time. The metal sheath of stainless steel is welded to the **bottom** (1) and finely polished, which ensures a constant diameter dimension over the entire heater length, thus giving better contact with the heated area and more efficient heat transfer. **Sealant** (6) prevents moisture ingress into the heater from the **power connection** (8) end. Stainless steel pins or wire stranded are used for power connections, to which power supply cords are connected.

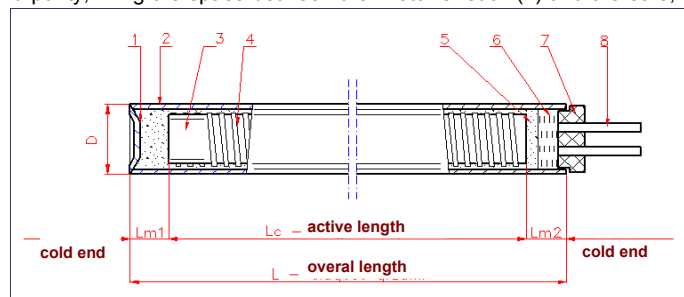

### TECHNICAL DATA

	Type GP	Type GPF
Characteristics	Cartridge heaters for most applications are marked by high quality, long service life and are attractively priced.	GPF heaters are manufactured using superior materials, and stringent design and manufacture criteria ensure high quality for the most demanding applications, and enable very high surface load values, as well as high working temperature.
Sheath material	stainless, steel, acid proof 1H18N9T	steel alloy Incoloy 800
Resistance wire material	nickel-chromium alloy, NiCr 80/20	
Heater diameter	metric: 6.5 8 10 12.5 14 16 18 20 24 26 mm imperial: 1/4" 3/8" 1/2" 5/8" 3/4" On special order, we can also manufacture heaters in the diameter range from D = 6.0 to D = 50 mm	metric: 6.5 8 10 12.5 14 16 18 20 25 mm imperial: 1/4" 3/8" 1/2" 5/8" 3/4" 1"
Diameter tolerance	Depending on the surface load, the diameter tolerance may vary For Pr ≤ 5 W/cm <sup>2</sup> D <sup>+0.2</sup> For Pr = 5 - 20 W/cm <sup>2</sup> D <sup>-0.02 -0.08</sup> For Pr = 21 - 35 W/cm <sup>2</sup> D <sup>-0.00 -0.02</sup>	Heaters are polished to D <sup>-0.02 -0.08</sup>
Length range	from 20 to 1000 mm as per customer requirements	Depending on the heater diameter, even up to 3500 mm at D = 25 mm
Length tolerance	L ± 1.5% min 2.0 mm	L ± 2.0% min 2.4 mm
Cold ends Lm1, Lm2	Depending on the heater diameter, the values are: min. 4 - 8 mm- from the bottom end min. 6 - 10 mm from the insulator end	min. 6 mm from the bottom end min. 6 mm from the insulator end
Max. surface load	35 W/cm <sup>2</sup>	62 W/cm <sup>2</sup>
Heater wattage	20 – 3000 W <sup>+5, -10</sup> [%]	Up to 10000 W <sup>+5, -10</sup> [%]
Max. heater temperature	500°C (measured on heater sheath)	870°C (measured on heater sheath)
Supply voltage	12 ÷ 400 V	12 ÷ 400 V

## APPLICATION

Cartridge heaters are primarily designed to heat up solids and usually work in holes drilled in metal parts. They can also be used to heat up liquids (water, oil, emulsion) and gases. The application of the appropriate steel grade renders the heaters resistant to corrosion and oxidation caused by chemical and weather factors, temperature and pressure.

### Typical applications:

**Plastic industry;** hot channel moulds, injector moulding nozzles,; cupping, stamping and welding punches in packaging machines

**Footwear industry** vulcanizing presses, mould heaters, extruders

**Foundry** core box and chill heaters, vacuum furnaces

**Medical and lab technology** distilling devices, oil heaters, soldering dippers, inhalation and sterilising equipment

**Timber industry** stamps for burning, varnish and paint sprayers

**General machine engineering** printing and bookbinding machines, coil winders

**Automotive industry** driers and heaters in braking systems, cylinder head and sump heaters in Diesel engines

### CARTRIDGE HEATER WITH EMBEDDED THERMOCOUPLE – TYPE GPT | GPFT

These heaters have an embedded Fe-CuNi (iron - constantan) thermocouple. They are used in equipment where, due to space constraints, a separate measuring device cannot be used.

Heaters up to 100 mm in length have the thermocouple's hot junction at the bottom of the metal sheath. With lengths above 100 mm, the hot junction is located at the mid point of the heater.

Structure and basic dimensions as for GP and GPF heaters.

### Thermocouple:

FE-CuNi (type J), electrically insulated from the casing, designed to DIN 43713



positive - iron (Fe)

negative - constantan (Cu-Ni)

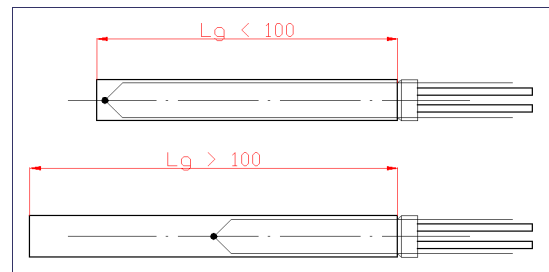
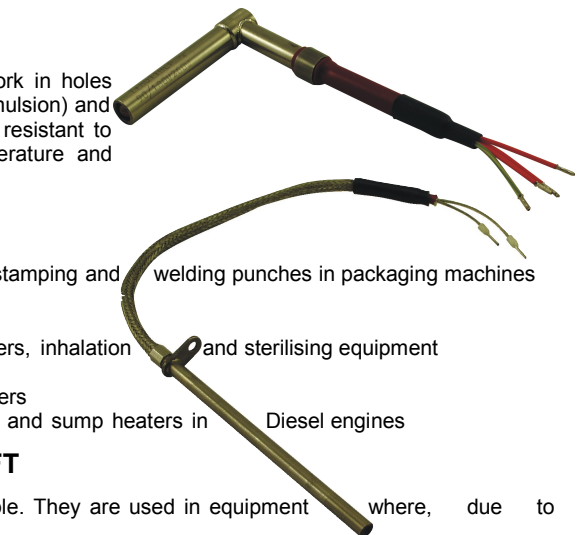
GPFT heaters may use thermocouples K (NiCr-NiAl).

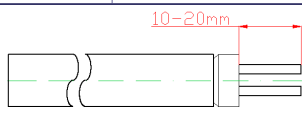
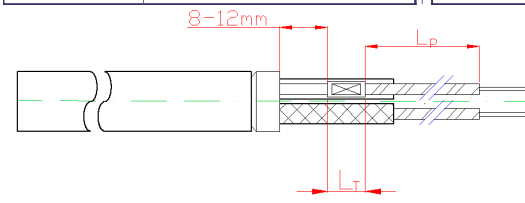

## ELECTRICAL CONNECTION

Code	Type of connection	Code	Type of connection	Code	Type of connection
T	terminal pin	TP	terminal pin + cord	LP	terminal pin + cord
					
L	cord				
<p>Power connection can be by a rigid pin or flexible wire stranded, covered in insulating jacketed.</p> <p>Stranded wires are used where high connection flexibility is required, or when the connection needs to be bent while adhering to the heater. The maximum stranded wire length is 300 mm. Stranded wires are fitted only to special orders.</p>		<p>Cartridge heaters are fitted with power supply cords connected with the pin using the clamping bushes. The connection spot is covered with insulating jacket.</p>		<p>Used for flexible power connections, not longer than 300 mm</p> <p>Power cord is clamped with the clamping bush to the flexible power connection (stranded wire). The parameters are the same as for the cord clamped to the pin.</p>	

### Types of conductors

Depending on the heater diameter, the following are used:

- copper wire 0.75 mm<sup>2</sup>; 1.0mm<sup>2</sup>; 1.5 mm<sup>2</sup>; 2.5 mm<sup>2</sup> in MZLB teflon coating or LGS silicon coating. Thermal strength: 180°C.
- nickel wire 0.75 mm<sup>2</sup>; 1.0mm<sup>2</sup>; 1.5 mm<sup>2</sup>; 2.5 mm<sup>2</sup> in cotton coating with glass fibre. Thermal strength: 350°C.

The length of the cord  $L_p$  is determined based on customer requirements. The length of the bush connecting  $L_t$  from 8 to 12 mm, depending on the diameter.

**MANUFACTURE OPTIONS**

**CARTRIDGE HEATER WITH STRIPWOUND HOSE (STEEL BRAIDED, SILICON JACKET)**

The stripwound hose is made of spirally coiled steel strip. The steel braiding is the most flexible protection for the connection wires. The shield protects the connection wires against mechanical damage and damage from sharp edges. They facilitate cable running in the environment which can easily damage the connection wires. Silicon jacket protects connection wires against moisture, oil, cleaning agent and fume contamination..

Code	Type of connection
OW	stripwound hose connected axially
OO	steel braid, connected axially
OS	silicon jacket connected axially
KW	stripwound hose, angular connection
KO	steel braid, angular connection
KS	silicon jacket, angular connection

**Axial connection**

Depending on the heater diameter, there are two ways to connect the stripwound hose (metal braid or silicon jacket):

<p>The stripwound hose (steel braid or silicon jacket) is mounted directly on the heater with a clamping bush - applies to heaters with diameter <math>D \leq 12,0</math> mm</p>	<p>Intermediate bush is welded to the heater, with the stripwound hose (steel braid or silicon jacket) connected to it with the clamping bush - applies to heaters with diameter <math>D \geq 12,5</math> mm</p>
<p>Length of clamping bush <math>L_{Tz} = 10</math> mm                  Length of intermediate bush <math>L_{Tp} = 7 \div 8</math> mm</p>	

**Angular connection**

The angular connection is designed to facilitate the heater connection.

<p>Angular shield is soldered to the heater with the stripwound hose (steel braid or silicon jacket) connected to it.</p>	<p>A copper elbow is soldered to the heater, on which the stripwound hose (steel braid or silicon jacket) is clamped with the intermediate bush.</p>																																		
<p>Dimensions of the angular shield for different heater diameters:</p> <table border="1"> <thead> <tr> <th>D [mm]</th> <th>6,5</th> <th>8,0</th> <th>9,5</th> <th>10,0</th> <th>12,5</th> <th>14,0</th> <th>16,0</th> <th>18,0</th> <th>19,0</th> <th>20,0</th> </tr> </thead> <tbody> <tr> <th>L [mm]</th> <td>12</td> <td>12</td> <td>12</td> <td>12</td> <td>16</td> <td>16</td> <td>18</td> <td>20</td> <td>22</td> <td>22</td> </tr> </tbody> </table>	D [mm]	6,5	8,0	9,5	10,0	12,5	14,0	16,0	18,0	19,0	20,0	L [mm]	12	12	12	12	16	16	18	20	22	22	<p>Dimensions of the copper elbow for different heater diameters:</p> <table border="1"> <thead> <tr> <th>D [mm]</th> <th>10,0</th> <th>12,5</th> <th>15,0</th> <th>16,0</th> <th>18,0</th> </tr> </thead> <tbody> <tr> <th>L [mm]</th> <td>21</td> <td>24</td> <td>29</td> <td>33</td> <td>35</td> </tr> </tbody> </table>	D [mm]	10,0	12,5	15,0	16,0	18,0	L [mm]	21	24	29	33	35
D [mm]	6,5	8,0	9,5	10,0	12,5	14,0	16,0	18,0	19,0	20,0																									
L [mm]	12	12	12	12	16	16	18	20	22	22																									
D [mm]	10,0	12,5	15,0	16,0	18,0																														
L [mm]	21	24	29	33	35																														

**CARTRIDGE HEATER WITH POWER CONNECTION DIRECTLY FROM THE HEATER AT 90°**

To be used in confined space

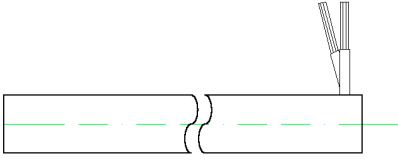
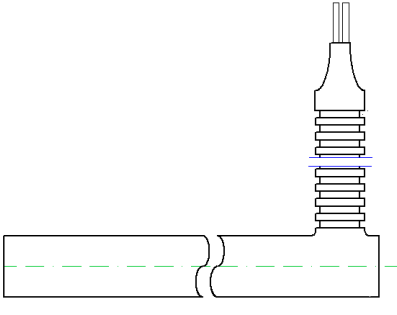
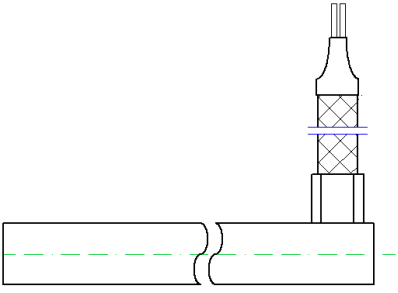
		
<p>Power connection directly from the heater is protected by high-temperature insulating jacket.</p>	<p>Power connection protected with stripwound hose, silver soldered directly to the heater.</p>	<p>Power connection protected with steel braid, clamped on the intermediate bush.</p>

**MOISTURE-RESISTANT CARTRIDGE HEATER**

These heaters are tightly sealed against moisture ingress. There is an option of adding a thermocouple and earth lead.

**Axial connection**



**Angular connection**

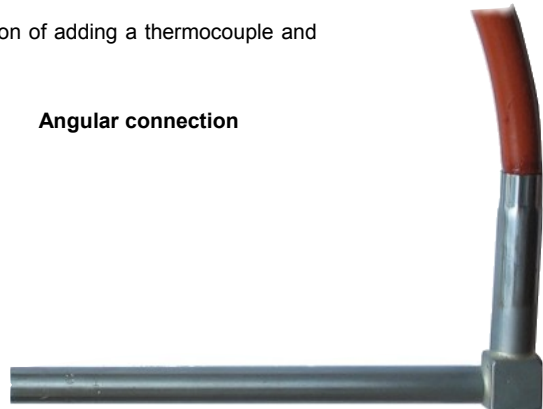

**CARTRIDGE HEATER WITH EARTH LEAD**

Earth terminal PE is mounted to the heater casing. It protects the user and the heater against consequences of breakdown to the casing.

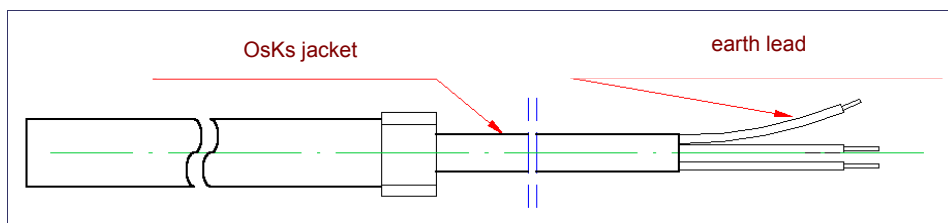

**CONICAL CARTRIDGE HEATER**

The heater diameter is tapered conically, 1:50. The conical shape of the heater ensures a precise fit with the hole. Good heat distribution depends on precise fit, so here the risk of overheat is mitigated.

Bush with M20x1.5 thread is optional.

Dw = 13,7 ÷ 15,7 mm  
L = 60 ÷ 160 mm

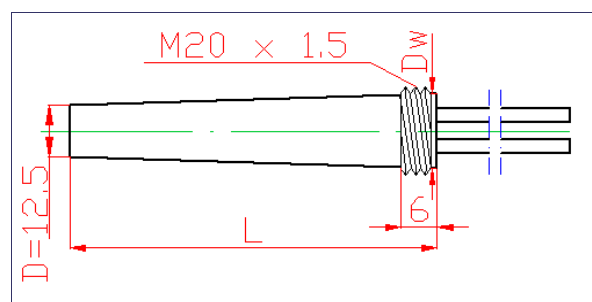

**CARTRIDGE HEATER WITH UNEVEN POWER DISTRIBUTION**

This heater is internally divided into sections that emit different power values P1, P2, P3... Minimum section length is 50 mm. Uneven power distribution enables higher or lower temperature at ends, or cold zone in the central section of the heater.

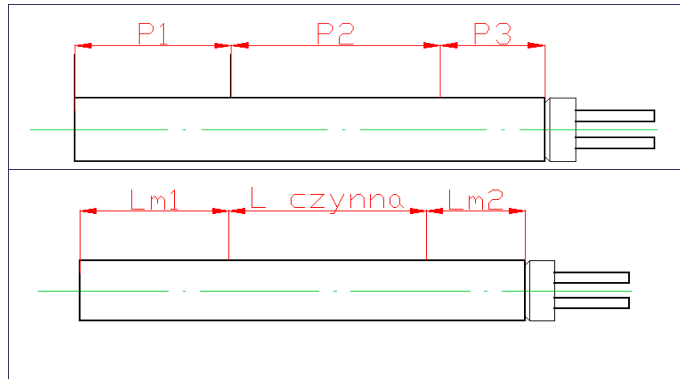

**CARTRIDGE HEATER WITH EXTENDED COLD ZONES**

Values of cold zones Lm1, Lm2 are different from standard values. The extended cold zones are recommended where the power connection is exposed to excessive temperatures or where it is required that the heater is hot over a specific length.

**CARTRIDGE HEATER WITH A MOUNTING BUSH**

The heater is fitted with a threaded bush to securely mount the heater in the hole, or if liquid is heated up, to set the heater in the tank wall. It enables a quick and tight-fitting installation of the heater in the hole. The threaded bush has a hexagonal flange, which makes it easier to remove the heater from non-clearance holes. Bush materials: carbon steel, brass, stainless steel.

**Typical threads for mounting bushes:**

Heater diameter	Thread	width across flat (s)
6,5	M10 x 1,25	17
8,0	M12 x 1,25	17
10,0	M14 x 1,5 M16x1,5	19
12,5	M18 x 1,5 G1/2"	24, 27
16,0	M22 x 1,5 G3/4" G1"	27, 32, 41
18,0	M22 x 1,5 G3/4" G1"	27, 32, 41
20,0	G3/4" G1"	32, 41



**CARTRIDGE HEATER WITH A MOUNTING PLATE**

The mounting plate makes it easier to mount and position the heater in the hole. The shape and dimensions of the mounting plate are as per the customer requirements.

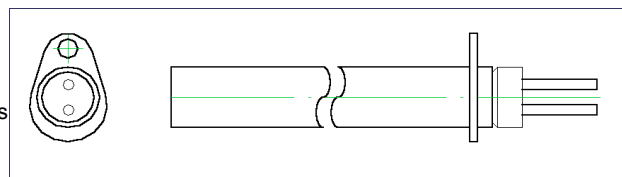

**CARTRIDGE HEATER IN THE FLANGE OR HEAD**

It is possible to mount cartridge heaters in flanges and heads, thus creating a cartridge heating unit. Flanges and heads are manufactured to special orders and as per the specific requirements.

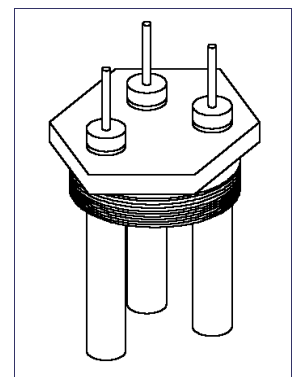

**DUAL VOLTAGE OR MULTI-PHASE POWER SUPPLY CARTRIDGE HEATER**

It is possible to construct a cartridge heater with separate hot zones, each supplied from a separate phase.

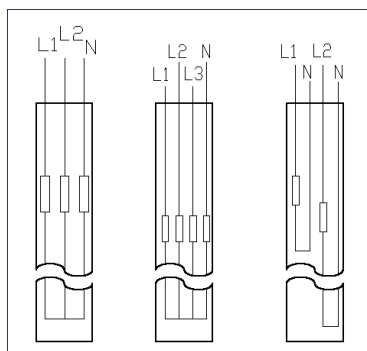



**SELECTION AND OPERATION OF CARTRIDGE HEATERS**

**Power ranges**

The diagrams below present the permitted wattages for the heater at 230V supply voltage.

- Pr ≤ 5 [W/cm<sup>2</sup>]
- Pr = 6 - 20 [W/cm<sup>2</sup>]
- Pr = 21 - 35 [W/cm<sup>2</sup>]
- Pr = 36 - 60 [W/cm<sup>2</sup>]

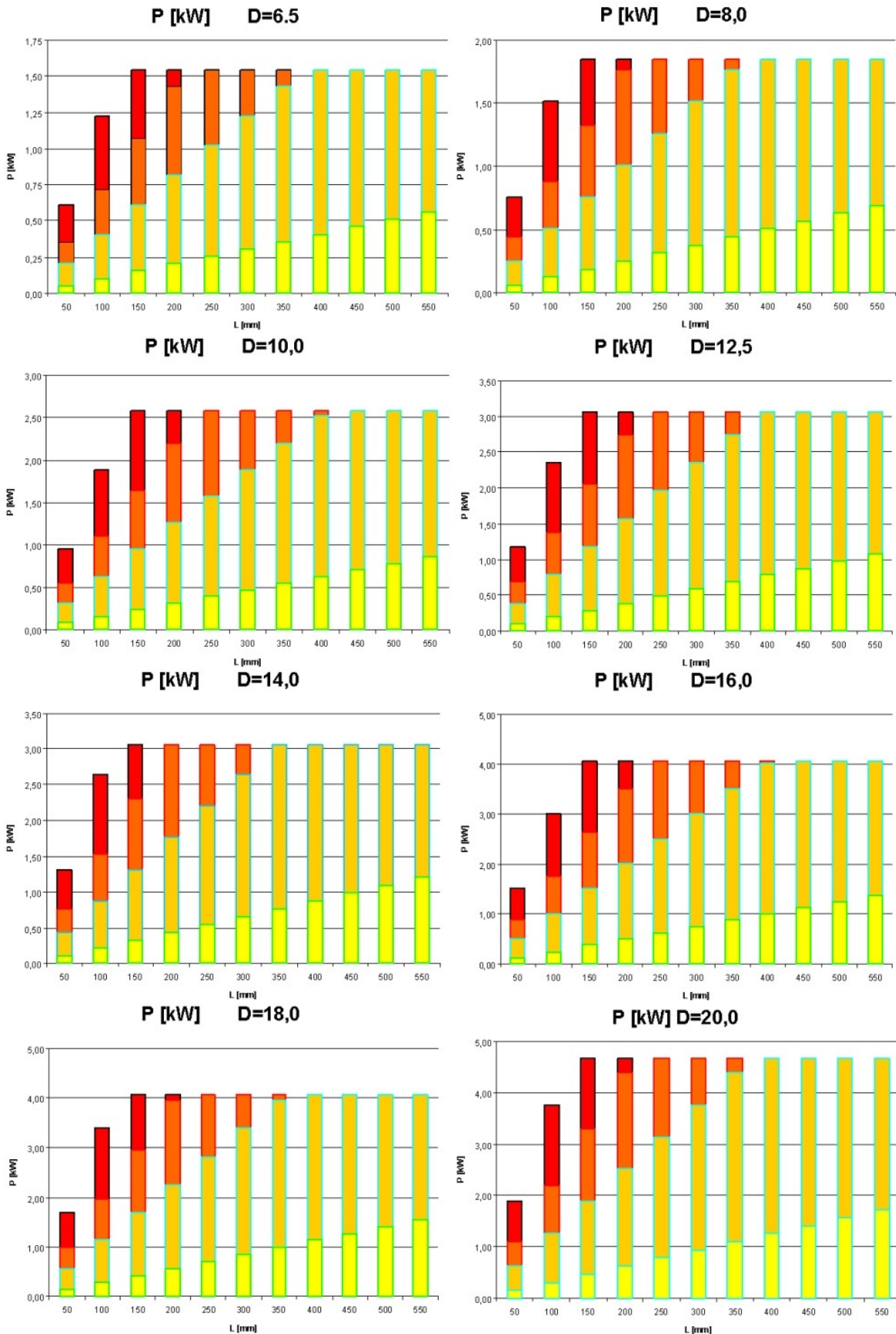

**Permitted clearance**

Clearance (**Z**) is to mean the difference between the diameter of the hole **D<sub>0</sub>**, in which the heater is set, and the diameter of the heater **D**. Maximum clearance **Z<sub>max</sub>** is the difference between the maximum diameter of the hole **D<sub>0max</sub>**, and the minimum diameter of the heater **D<sub>min</sub>**.

$$Z_{max} = D_{0max} - D_{min}$$

T<sub>0</sub> - hole diameter tolerance

T<sub>g</sub> - heater diameter tolerance

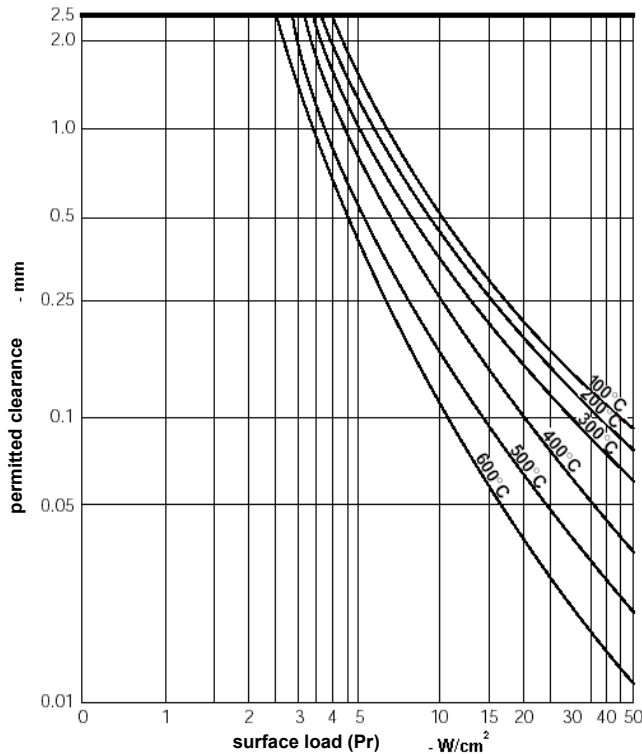
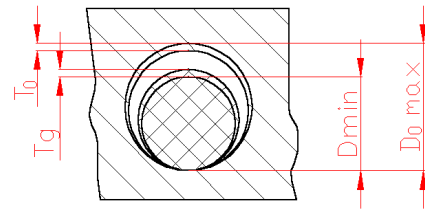

Permitted maximum clearances, depending on the load on heaters at specific temperatures is presented below:

**Guidelines on heater hole drilling**

for **Pr < 5 W/cm²** – holes as per the table below are recommended::

Heater D	6,5 <sup>+0,2</sup>	8,0 <sup>+0,2</sup>	10 <sup>+0,2</sup>	12,5 <sup>+0,2</sup>	14 <sup>+0,2</sup>	16 <sup>+0,2</sup>	18 <sup>+0,2</sup>	20 <sup>+0,2</sup>
Hole D	6,7 <sup>+0,2</sup>	8,2 <sup>+0,2</sup>	10,2 <sup>+0,2</sup>	12,7 <sup>+0,2</sup>	14,2 <sup>+0,2</sup>	16,2 <sup>+0,2</sup>	18,2 <sup>+0,2</sup>	20,2 <sup>+0,2</sup>

for **Pr = 5 ÷ 20 W/cm²** – holes for the heater should be to H7

for **Pr = 21 ÷ 35 W/cm²** – holes for the heater should be H7, individual fitting is recommended

for **Pr = 36 ÷ 60 W/cm²** – holes for the heater must be individually fitted

**OPERATING TIPS**

- Only the best possible heat abstraction ensures long service life of cartridge heaters.
- Heaters with the surface load of up to 20 W/cm<sup>2</sup> should be placed in holes to the precision class H7.
- At extreme loads (above 20 W/cm<sup>2</sup>), individual fitting of heaters with the holes is recommended, so that the maximum clearance for each heater-hole combination is the least.
- The necessary quality of the hole surface and the drilling precision meeting the assumed diameter tolerance is obtained by using the expansion drill for the finishing work
- It is recommended to design the tool (piece of equipment) in which the heater works as a split one, with the partition line along the axis of the hole. If both parts are clamped, the surface of the hole more tightly fits together with the shield of the heating element.
- The assembly and disassembly of the heater is easier when the hole is a clearance, two-step hole.
- If several heaters are designed for the piece of equipment, located one next to another, the minimum clearance between the neighboring heaters should not be less than the diameter of the bigger of the two.
- After a long heater downtime, it is recommended that it gradually reaches its full rated power, so-called soft start, by alternating 1/3 and 2/3 rated voltage, with a dozen or so minute intervals.
- The heater in the insulator and power connection section should be protected against mechanical damage and contact with liquids and their vaporous as breakdowns and leakage current may occur.
- Long storage of cartridge heaters is recommended only in hermetic packaging, or in rooms where there is no moisture.
- In the case that damping in the room is suspected, the heaters should be dried at approx. 100 - 150°C degrees Celsius for at least 8 hours.
- Assembly pastes should be used for the assembly. The paste in gel is applied on the heater and to the hole before the assembly. We offer copper and other metal-based paste, with anti-seize and anti galling effect in aggressive chemical environments and at high temps, which facilitates removal from the holes.

## Band heaters

### CHARACTERISTICS

Band heaters are micanite or ceramic insulated. The external casing is the stainless steel or brass jacket. The advantage of using micanite as an insulating material is in the minimum thickness of the heater (3.5 ÷ 4 mm), whereas ceramic band heaters are marked by excellent insulation properties and long service life. .

### APPLICATION

For heating: industrial piping, nozzles, film blowing machines, packaging machines, injectors, extruders

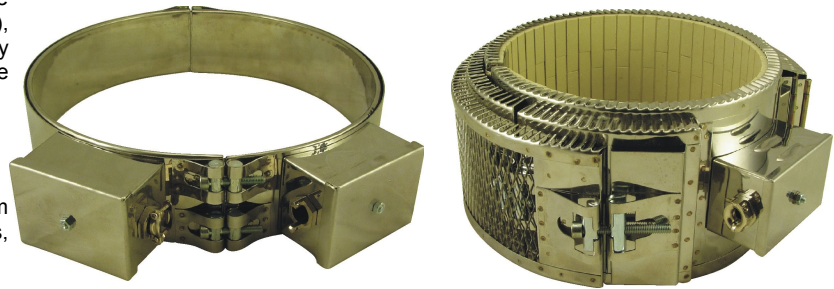

### TECHNICAL DATA

	Band heaters in micanite insulation	Band heaters in ceramic insulation
Inner diameter	Ø25 ÷ 1000 mm	Ø60 ÷ 1000 mm
Width	25 ÷ 1000 mm (greater widths in modular solutions)	32 ÷ 1000 mm
Thickness	3,5 ÷ 4 mm	12 ÷ 32 mm
Supply voltage	230 V, 220 V, 400 V, 380 V, 3x400V, 3x380V (or other)	
Max. surface load	4,5 W/cm <sup>2</sup>	7,5 W/cm <sup>2</sup>
Max. heater temperature	450°C (temperature of up to 500°C is allowed when excellent heat give-up is achieved)	550°C (temperature of up to 600°C is allowed when excellent heat give-up is achieved)
Casing material	Cr-Ni steel (AISI 321), brass	Cr-Ni steel (AISI 321)
Connections	type and method of power connection as per drawings or individual arrangements	
Extra features	- Adiabatic partition reducing heat radiation to the outside (by 25%) - option to use J, K, T thermocouple - encapsulated power supply connection	

## Flat heating elements

### CHARACTERISTICS

Flat heaters are micanite or ceramic insulated. The external casing is the stainless steel jacket. These heaters perform excellently when heating flat surfaces (hot plates, tank bases, machine and equipment housing).

**NOTE!** In order that the heating element is not damaged and transfers hits well, ensure the heating element may be screwed in or an additional clamping plate can be mounted good contact with the heated element, from the top, up to 3mm thick..

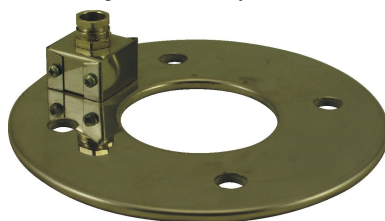

### APPLICATION

heating moulds and nozzles, tanks and plates, thermal packaging and sealing equipment, heat furnaces, food equipment, vulcanizing presses, air, duct and space heating, incubators, frost and moisture protection..



### TECHNICAL DATA

	Flat heaters in micanite insulation	Flat heaters in ceramic insulation
Thickness	3,5 ÷ 4 mm	12 ÷ 15 mm
Supply voltage	230 V, 220 V, 400 V, 380 V, 3x400V, 3x380V (or others)	
Max. surface load	4 W/cm <sup>2</sup>	7 W/cm <sup>2</sup>
Max. heater temperature	450°C	550°C
Casing material	Cr-Ni steel (AISI 321)	Cr-Ni steel (AISI 321)
Connections	type and method of power connection as per the drawings next to band heater characteristics or as individually agreed	

**ELECTRICAL CONNECTION (BAND AND FLAT HEATING ELEMENTS)**

<b>Pp λ</b> - where $\lambda = 45^\circ, 90^\circ, 135^\circ, 180^\circ$ or as individually agreed	<b>Psp λ</b> - where $\lambda = 90^\circ, 135^\circ, 180^\circ$ or as individually agreed	<b>GE-10 λ</b> - GE-10 power connection, where $\lambda = 90^\circ, 135^\circ, 180^\circ$
<b>K λ</b> - with a connection block inside the box, where $\lambda = 90^\circ, 135^\circ, 180^\circ$	<b>WG-2 λ</b> - WG-2 power socket, where $\lambda = 45^\circ, 135^\circ, 180^\circ$	<b>SM5 λ</b> - M5 screw connection, where $\lambda = 45^\circ, 135^\circ, 180^\circ$
<b>Psb λ</b> - where $\lambda = 45^\circ, 90^\circ, 135^\circ, 180^\circ$ or as individually agreed	<b>Ps λ</b> - where $\lambda = 90^\circ, 135^\circ, 180^\circ$ or as individually agreed	<b>Ppd</b> – leads on both sides of the clip <b>Ppj</b> – leads on one side of the clip

**Ceramic heating elements**

These heaters, owing to the heat radiation phenomenon, heat up the medium that surrounds them. Their modular structure, the primary component of which is the ceramic profile, ensures even heat distribution across the heater surface.

**STRUCTURE:**

Typically, a cylindrical ceramic heater is composed of the following:

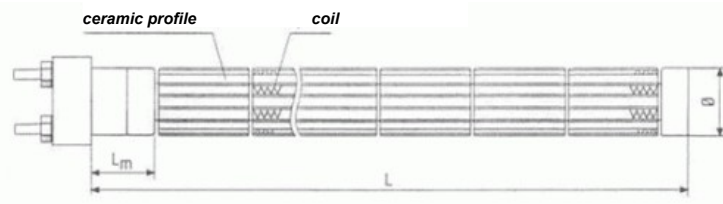

**ceramic profile** - circular section, is a single module of the cylindrical heater, and the number of the modules depends on the length (L), diameter (Ø), power and application of the heater. The modules are connected axially, mounted to the head, where the power cords may be connected to, or from which (if required) there is a direct power connection. The distance (Lm) is the cold zone, the length of which is specified by the customer.

**heating coil** - placed in the ceramic profile, made of top quality resistance wire by Kanthal® (which ensures very long service life), its diameter is selected to match the supply wattage, voltage and size of the heater.

Ceramic heaters are made of top quality ceramics, marked by high hardness index, excellent resistance to mechanical damage and extremely long service life.

**TECHNICAL DETAILS:**

<b>Length (L)</b>	200 ÷ 4000 mm
<b>Diameter (Ø)</b>	12; 16; 32; 36; 45; 57 mm (or other)
<b>Supply voltage</b>	220; 230; 380; 3x380; 400; 3x400 V (or other)
<b>Max. heater temperature</b>	800 [°C]
<b>Wattage</b>	250 - 8000 W
<b>Max. surface load</b>	7 W/cm <sup>2</sup>

**EXAMPLE APPLICATIONS:**

- heating:** air, ducts, spaces, as well as liquids, if encased;
- furnaces:** heat storage, tiled;
- bakery, galvanizing workshops, rubber and plastics processing;**

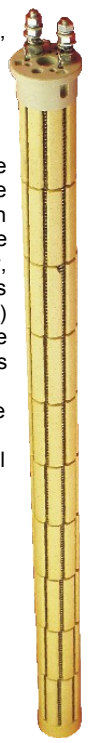

## Plating heaters

### HEATING ELEMENTS IN QUARTZ OR NOBLE STEEL CASING

The immersion heater is composed of quartz or noble metal sheath, heating insert and splashproof head. The ring code for minimum immersion depth is permanently imprinted on the casing. It determines the length of the hot zone of the heater. The heating insert is ceramic. The head is made of polypropylene, resistant to baths and their vaporous and, together with rubber gaskets, is the splashproof shield for the heater's power terminals.

### TECHNICAL DATA

<b>Supply voltage</b>		230V to 3,5 kW 400V or 3x400V above 3,5 kW
<b>Working temperature</b>		to 150°C
<b>heater sheath material</b>	Type <b>GGK</b>	quartz glass
	Type <b>GGG / GGSM</b>	noble steel 1H18N9 or H17N13M2T
	Type <b>PGW</b>	unalloyed steel with zinc coating
The heaters can be operated in upright position		

### APPLICATION AND AVAILABLE VERSIONS

#### TYPE GGK

Heating elements in quartz glass sheath, pipe diameter Ø51

#### Application:

- acidic baths, metallic solutions (Ni, Cd, Cr, Fe, Cu, Pt, Zn, Sn)
- organic acids
- soldering liquids
- table salt solutions and solutions with potassium permanganate
- acidified rinse water (no fluorine), mains water and sea water
- fluxing agents

**NOTE!** Do not use GGK heating elements in alkaline baths!

#### TYPE GGS AND GGSM

Heating elements in noble steel casing (steel 1H18N9 - type **GGG** or H17N13M2T - type **GGSM**), pipe diameter Ø54

#### Application:

- degreasing baths
- degreasing metallic baths (Cu, Cd, Au, Ag, Zn, Sn, brass)
- rinse water baths contaminated with alkali (no halogens)

**NOTE!** Do not use GGS heating elements in baths with KOH and NaOH lyes



#### TYPE PGW

Heating elements in R35 steel casing with zinc coating, pipe diameter Ø35

#### Application:

- for NON-AGGRESSIVE process bath heating

### STANDARD VERSIONS:

GGK	GGG	GGSM	Voltage	Wattage	Length L	Min. immersion Lmin
GGK-1,0kW/230V	GGG-1,0kW/230V	GGSM-1,0kW/230V	230V	1000W	390 mm	280 mm
GGK-1,25kW/230V	GGG-1,25kW/230V	GGSM-1,25kW/230V	230V	1250W	390mm	280 mm
GGK-1,5kW/230V	GGG-1,5kW/230V	GGSM-1,5kW/230V	230V	1500W	590 mm	440 mm
GGK-1,8kW/230V	GGG-1,8kW/230V	GGSM-1,8kW/230V	230V	1800W	590 mm	440 mm
GGK-2,0kW/230V	GGG-2,0kW/230V	GGSM-2,0kW/230V	230V	2000W	790 mm	580 mm
GGK-2,2kW/230V	GGG-2,2kW/230V	GGSM-2,2kW/230V	230V	2200W	790 mm	580 mm
GGK-2,5kW/230V	GGG-2,5kW/230V	GGSM-2,5kW/230V	230V	2500W	950 mm	700 mm
GGK-2,8kW/230V	GGG-2,8kW/230V	GGSM-2,8kW/230V	230V	2800W	950 mm	700 mm
GGK-3,5kW/230V	GGG-3,5kW/230V	GGSM-3,5kW/230V	230V	3500W	1310 mm	1000 mm
GGK-3,5kW/400V	GGG-3,5kW/400V	GGSM-3,5kW/400V	400V	3500W	1310 mm	1000 mm
GGK-4...5kW/400V			400V	4 ÷ 5 kW	1310 mm	1000 mm
GGK-4...6kW/400V	GGG-4...4,5kW/400V	GGSM-4...4,5kW/400V	400V	4 ÷ 4,5 kW	1590 mm	1250 mm
		GGSM-6kW/400V	400V	6 kW	1990 mm	1400 mm
		GGSM-6kW/400V	400V	6 kW	2490 mm	1800 mm
	<b>PGW</b>		<b>Voltage</b>	<b>Wattage</b>	<b>Length L</b>	
	PGW-0,8kW/230V		230V	800W	335 mm	
	PGW-1,0kW/230V		230V	1000W	420 mm	
	PGW-1,6kW/230V		230V	1600W	580 mm	
	PGW-2,0kW/230V		230V	2000W	720 mm	
	PGW-3,15kW/230V		230V	3150W	1020 mm	



**TUBULAR HEATING ELEMENTS IN PFA HEATFLON® PH SERIES TEFLON SHEATHING**

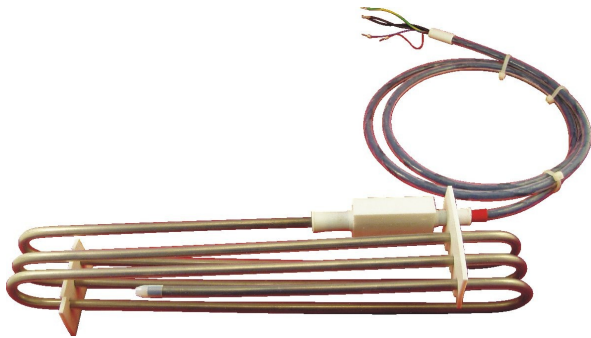

PH series Heatflon® heaters are made of tubular heating elements in PFA sheathing. The head of the heater is made of PTFE and the power cord of PFA. Both the hot zone and head with the core have watertight connections, so the heaters may be used in very aggressive working conditions. The heaters may also be bent based on specific customer orders. Over 50 bending shapes are available..

**HOT PLATES IN PFA HEATFLON® H SERIES SHEATHING**



Heatflon® hot plates are designed primarily for aggressive liquid electric heating for plating, semi-conductor and lab technology and in the chemical sector. Owing to their flat structure, they save a lot of space as compared to other heaters.

**Characteristics of Heatflon® Series H hot plates:**

- universal in use owing to the application of fluoric compounds, as opposed to titanium, quartz, graphite, etc.
- resistant structure, unbreakable,
- are totally anti-adhesive, owing to the perfectly smooth outer surface,
- easy to clean
- flat structure saves a lot of space
- corresponding low wattage means safety to materials in the vicinity. It also reduces the impact of electrolytes and chemicals.
- mountable in various positions, to the wall or at the bottom of the tank, owing to the flexible power cord,
- safety-checked at 5,000 volts in water bath,
- durable, owing to 2mm thick PTFE insulation, no corrosion and penetration through the sheath 2 mm
- no maintenance needed, no wear
- problem-free, long service life, thus very economical in use.

**Silit heating elements**

Silit heating elements are made using silit, i.e. a mixture of silicon carbide (SiC), free silicon and glycerine. They are marked by high durability at very high working temperatures and resistance increase (power drop) along with the temperature increase.



In the typical version, silit heating elements are manufactured as rods with the hot zone located centrally, and cold zones with reduced resistance at both ends. Power connection is made through terminals covered in aluminum powder

Typical dimensions of silit heating elements	
d x D x l x L (m)	R[Ω]
8x14x100x360(130)	2,4
8x14x150x450(150)	3,6
8x14x180x480(150)	4,4
14x22x200x700(250)	1,8
14x22x250x750(250)	2,2
14x22x400x1100(350)	3,5
18x28x250x950(350)	1,3
18x28x300x1000(350)	1,7
18x28x500x1300(400)	2,7

**FEATURES:**

- application in the temperature range from 600 to 1600°C
- option to work in air and other environments; the maximum working temperature depends on the type of the atmosphere in the furnace
- resistance to much greater electric loads than in the case of metallic components, whilst maintaining excellent performance, both in continuous and periodic heating processes,
- mountable in upright and horizontal position

**APPLICATION:**

- starting from small laboratory stoves to big industry heating processes in a broad range of temperatures,
- furnaces for thermal glass, ceramics and metal etc. processing
- e.g. stoves and furnaces such as: KO-14, KS-400, KS-520, KS-600, KS-800, PSK-1, PSK-7, PSK-31, PSR-O, PSR-1

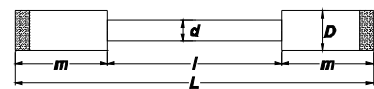

m - length of cold end (part)  
 l - length of hot zone (hot part)  
 L - overall length  
 d/ D - hot/cold part diameter

Maximum working temperature		
Atmosphere	Temp [°C]	Notes
clean, dry air	1625	
clean oxygen	1500	oxidation quicker than in air
nitrogen	1350	at > 1350°C, silicon nitrides are formed 1350°C
clean hydrogen	1200	oxidation in humid atmosphere
vacuum	1200	typically only short periods of use

## Coil heating elements

Coil heating elements may be arranged in any shape where heat supply is needed from all sides. A broad range of applications requires a variable structure of the heating element. We offer circular, square or rectangular-section coil elements, power supplied from one or two ends.

### APPLICATION

- hot channel nozzles
- metal moulds
- semi-conductor and precision industry
- heating rods
- medical instruments
- lab and research equipment
- catering and food warming equipment
- lamination equipment and printing presses
- textile industry
- air heating
- heating in vacuum

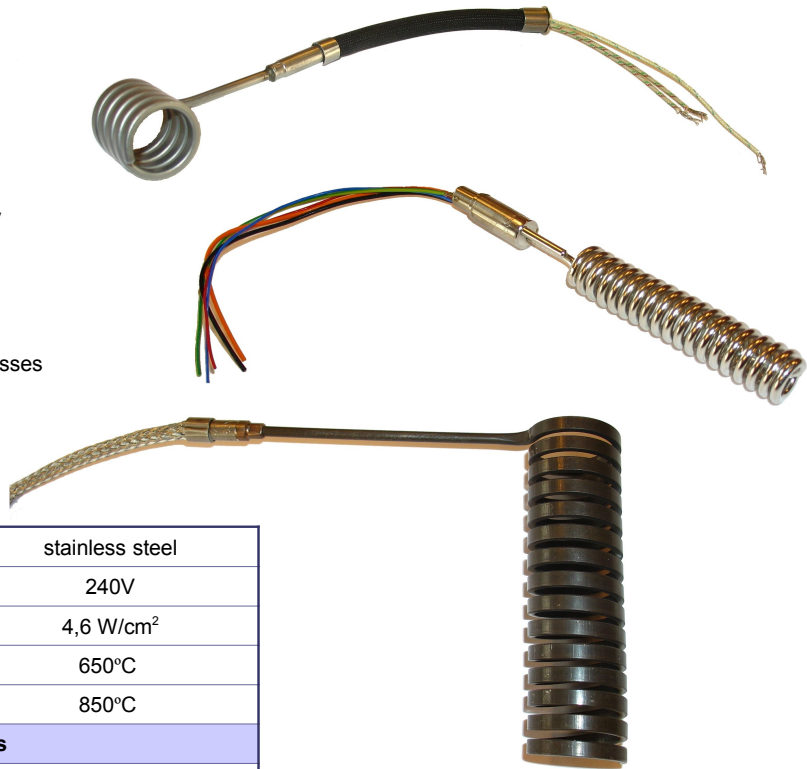

### TECHNICAL DATA

<b>Jacket material</b>	stainless steel
<b>Maximum voltage</b>	240V
<b>Max. surface load</b>	4,6 W/cm <sup>2</sup>
<b>Max. continuous work temperature</b>	650°C
<b>Max. instantaneous work temperature</b>	850°C
<b>Manufacture options</b>	
- internal thermocouple insulated from the sheath, allowing working temperature control - wire sheathing as steel braid or stripwound tube	

Diameters and cross-sections [mm]	□ 5,5 x 3,9	∅ 4,0	□ 3,2 x 3,2	∅ 3,0	□ 2,5 x 4,0	□ 2,5 x 4,3	□ 1,8 x 3,2 <sup>(*)</sup>	∅ 1,8	□ 1,4 x 2,3 <sup>(*)</sup>	∅ 1,3 <sup>(*)</sup>
<b>Maximum current</b>	12 A	6 A	6 A	6 A	6 A	6 A	6 A	4 A	2,5 A	3 A
<b>Minimum bend radius</b>	5 mm	4 mm	4 mm	3,5 mm	4 mm	4 mm	4 mm	3 mm	2,5 mm	2,5 mm
<b>Maximum length</b>	3000 mm	3000 mm	2000 mm	2000 mm	2000 mm	2000 mm	2000 mm	1500 mm	1200 mm	1200 mm

<sup>(\*)</sup> internal thermocouple option is excluded

## Full coil heating elements

Full coil heating elements transfer heat very efficiently. Special design, enabling work of the heating element at high temperatures and high surface loads.

### TECHNICAL DATA

<b>Jacket material</b>	stainless steel brass (inner part)
<b>Maximum voltage</b>	240 V
<b>Maximum wattage</b>	1000 W
<b>Maximum current</b>	4,5A
<b>Inner diameter</b>	∅10 ÷ ∅40 mm
<b>Length</b>	25 ÷ 300 mm
<b>Wall thickness</b>	2,5mm or 4,0mm
<b>Max. surface load</b>	50 W/cm <sup>2</sup>
Optionally, thermocouple is welded to the sheath, which allows working temperature control	



## Infrared radiators

Ceramic infrared radiators are heating elements made of highly refractory ceramic material with ceramic glaze coating. Inside the body sits a heating coil made of resistance wire. The operating principle is the thermal radiation phenomenon, consisting in the absorption and exchange into heat of radiation energy falling on heated objects. Depending on the wattage, the radiators emit electromagnetic waves, from 2 to 10 μm long.

The radiators are broadly used in the plastics, food, paper making and textile industry, in medical technology, surface technology and other. Their multipurpose properties come from e.g. high corrosion resistance, resistance to aggressive environments, sterility (very important for medical technology and food industry), option to control their operation (thermocouples), low thermal inertia.

### TYPE FSR

Type / dimensions / wattage	FSR	245x60mm	250	400	650	1000	W
	FSR/2	122x60mm	125	200	325	500	W
	FSR/4	60x60mm	60	100	200	250	W
<b>maximum surface load</b>			1,6	2,56	4,16	6,4	W/cm <sup>2</sup>
<b>typical working temperature</b>			400	500	620	730	°C
<b>maximum permitted temperature</b>			550	600	700	750	°C
<b>length of emitted wave</b>			2 – 10				μm
<b>heat-up time to 63% final temperature</b>			4,8	3,8	3,0	2,4	min
<b>average cooling time from final temperature to 200 °C</b>			7	9	11	12	min

radiators are optionally offered with an embedded thermocouple K (NiCr-NiAl)

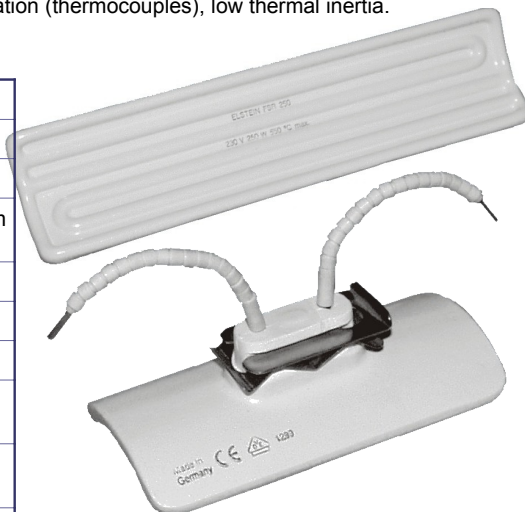

### TYPE HTS

These radiators exceed FSR radiators in terms of:

- energy efficiency, owing to thermal insulation used,
- continuous work temperature to 900 °C
- heat-up time is shorter than for FSR

Type / dimensions / wattage	HTS	122x122mm	250	400	600	800	1000	W
	HTS/1	245x60mm						
	HTS/2	122x60mm	125	200	300	400	500	W
HTS/4	60x60mm	60	100	150	200	250	W	
<b>maximum surface load</b>			1,6	2,56	3,84	5,12	6,4	W/cm <sup>2</sup>
<b>typical working temperature</b>			450	570	700	810	900	°C
<b>maximum permitted temperature</b>			700	750	800	850	900	°C
<b>length of emitted wave</b>			2 – 10				μm	
<b>heat-up time to 63% final temperature</b>			3,2	2,8	2,2	2	1,8	min
<b>average cooling time from final temperature to 200 °C</b>			5,5	7,5	9,5	70	11	min

radiators are optionally offered with an embedded thermocouple K (NiCr-NiAl)

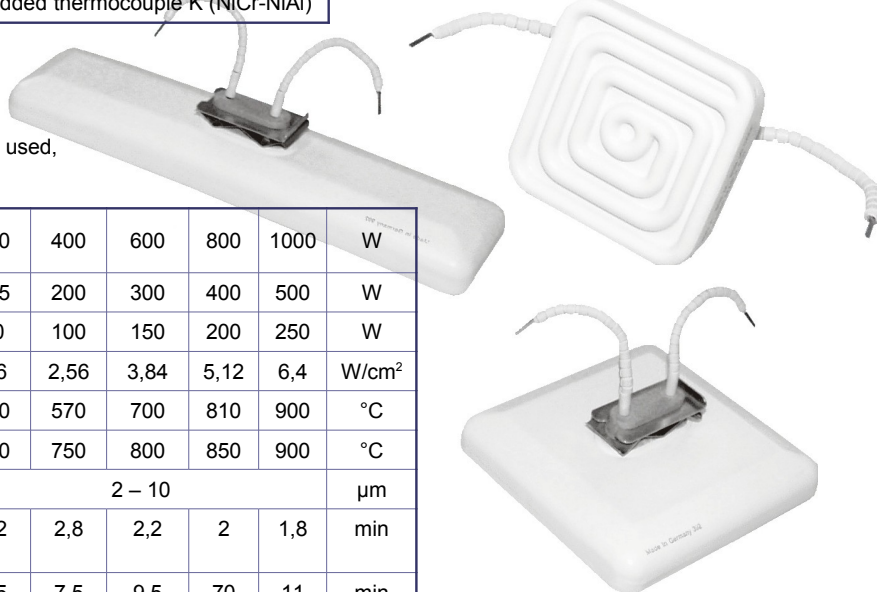

### TYPE SHTS

SHTS infrared radiators are optimised in terms of efficiency and used in heating panels. When employed, they enable an increase in the maximum surface load from 64 KW/m<sup>2</sup> to 76.8 KW/m<sup>2</sup>. The application of special black glaze, combined with gold-plated back wall and thermal insulation, enable optimum usage of the supplied electricity. At the working temperature of 900 °C, over electricity supplied is transformed into radiation towards the heated objects.

Type / dimensions / wattage	SHTS	122x122mm	1200	W
	SHTS/1	245x60mm		
	SHTS/2	122x60mm	600	W
SHTS/4	60x60mm	300	W	
<b>maximum surface load</b>			7,7	W/cm <sup>2</sup>
<b>typical working temperature</b>			860	°C
<b>maximum permitted temperature</b>			900	°C

When employed, they enable an increase in the maximum surface load from 64 KW/m<sup>2</sup> to 76.8 KW/m<sup>2</sup>. The application of special black glaze, combined with gold-plated back wall and thermal insulation, enable optimum usage of the supplied electricity. At the working temperature of 900 °C, over electricity supplied is transformed into radiation towards the heated objects.

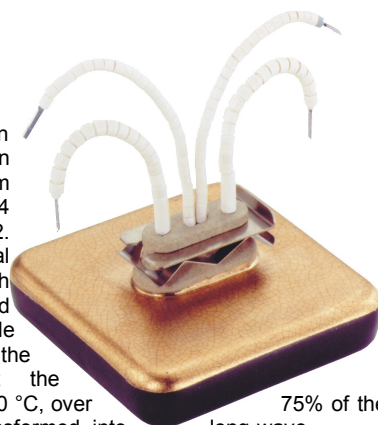

75% of the long-wave

### TYPE FSF



FSF infrared radiators are designed to work at temperatures up to 750°C and surface load up to 64 KW/m<sup>2</sup>. Compared to other radiator types, their height is reduced by approx. 45%, which makes it possible to install them in applications where there is shortage of space.

Type / dimensions / wattage	FSF FSF/1	122x122mm 245x60mm	250	400	600	800	1000	W
	FSF/2	122x60mm	125	200	300	400	500	W
	FSF/4	60x60mm	60	100	150	200	250	W
maximum surface load			16,0	25,6	38,4	51,2	64	kW/m <sup>2</sup>
typical working temperature			400	500	590	670	720	°C
maximum permitted temperature			750	750	750	750	750	°C
length of emitted wave			2 – 10					µm

radiators are optionally offered with an embedded thermocouple K (NiCr-NiAl)

### TYPE IOT

This infrared radiator type is manufactured in two sizes and two wattages, corresponding to the size. They have the so called "light bulb thread" E27, which enables a very quick and easy assembly in ceramic or metal holders with the ceramic insert. Their large, round radiation surface enables a very dense radiation area at low temperatures.

Their primary properties include: low price, high mechanical strength, resistance to temperature variations, low power intake, long life

Type	IOT/75		IOT/90		W
	moc elementu	60	100	150	
diameter / height	ø75 x 95 mm		ø95 x 135 mm		
typical working temperature	290	380	420	510	°C
maximum permitted temperature	350	420	450	530	°C
average temperature at thread	70	85	110	140	°C
length of emitted wave	2 – 10				µm
heat-up time to 90% final temperature	6,8	5,8	5,0	3,9	min



### TYPE HLS

Gold-plated reflector and the special ceramic coating causes these radiators to behave similarly to the ideal "black radiators". Over 80% of the energy supplied is transmitted to the light-exposed products as infrared radiation. Heat-up time to 1000°C - below one minute

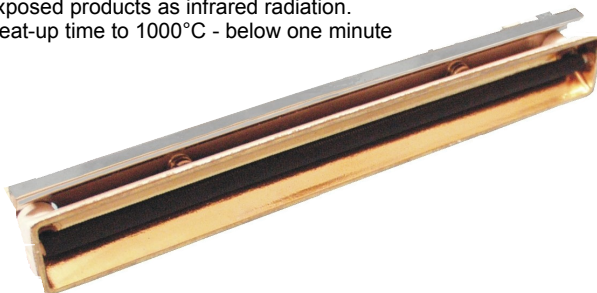

Type / wattage	HLS	245x32mm	750	W
	HLS/2	122x32mm	325	W
maximum surface load			9	W/cm <sup>2</sup>
typical working temperature			1000	°C
maximum permitted temperature			1100	°C
length of emitted wave			2 – 10	µm
continued heat-up time to 1000°C			<1	min
average cooling time from final temperature to 200 °C			4,5	min



**TYPE EBF**

The EBF panel is a ready-to-install and connect set of individual radiators with stainless steel reflectors mounted in the aluminium profile. These panels are manufactured based upon serial components of HTS or FSR type. EBF constituents are parts of the system that can be easily and conveniently installed in the existing machines. As modular systems, they may be used for furnace, continuous tunnel etc. construction.

Dimensions	A	B	B
EBF/25	255	217	190
EBF/50	505	467	440
EBF/75	755	717	690
EBF/100	1005	967	940



**TYPE BSH AND BSI**

BSH radiator panels with HTS radiators.  
 BSH type - aluminium casing,  
 BSI type - stainless steel casing

**Characteristics:**

- panel dimensions up to 1000 x 1500 mm, flat, compact structure
- surface load up to 40 kW/m<sup>2</sup>
- free assembly of high-temperature HTS radiators from 600 W (BSH panel) to 800W (BSI panel)

This system is composed of a small number of standard components. The complete panel is assembled at the production site. The user simply puts it in the appropriate framing and connects as appropriate.













**Dimensions of wattages of standard BSH and BSI panels:**

inside (outside)	250 (267)	375 (392)	500 (517)	625 (642)	750 (767)	875 (892)	1000 (1017)	1125 (1142)	1250 (1267)	1375 (1392)	1500 (1517)		HTS
<b>125 (142)</b>	0,50	0,75	1,00	1,25	1,50	1,75	2,00	2,25	2,50	2,75	3,00	kW	250W
	0,80	1,20	1,60	2,00	2,40	2,80	3,20	3,60	4,00	4,40	4,80	kW	400W
	1,20	1,80	2,40	3,00	3,60	4,20	4,80	5,40	6,00	6,60	7,20	kW	600W
<i>BSI only</i>	1,60	2,40	3,20	4,00	4,80	5,60	6,40	7,20	8,00	8,80	9,60	kw	800W
<b>250 (267)</b>	1,00	1,50	2,00	2,50	3,00	3,50	4,00	4,50	5,00	5,50	6,00	kW	250W
	1,60	2,40	3,20	4,00	4,80	5,60	6,40	7,20	8,00	8,80	9,60	kW	400W
	2,40	3,60	4,80	6,00	7,20	8,40	9,60	10,80	12,00	13,20	14,40	kW	600W
<i>BSI only</i>	3,20	4,80	6,40	8,00	9,60	11,20	12,80	14,40	16,00	17,60	19,20	kw	800W
<b>375 (392)</b>	1,50	2,25	3,00	3,75	4,50	5,25	6,00	6,75	7,50	8,25	9,00	kW	250W
	2,40	3,60	4,80	6,00	7,20	8,40	9,60	10,80	12,00	13,20	14,40	kW	400W
	3,60	5,40	7,20	9,00	10,80	12,60	14,40	16,20	18,00	19,80	21,60	kW	600W
<i>BSI only</i>	4,8	7,20	9,60	12,00	14,40	16,80	19,20	21,60	24,00	26,40	28,80	kw	800W
<b>500 (517)</b>	2,00	3,00	4,00	5,00	6,00	7,00	8,00	9,00	10,00	11,00	12,00	kW	250W
	3,20	4,80	6,40	8,00	9,60	11,20	12,80	14,40	16,00	17,60	19,20	kW	400W
	4,80	7,20	9,60	12,00	14,40	16,80	19,20	21,60	24,00	26,40	28,80	kW	600W
<i>BSI only</i>	6,40	9,60	12,80	16,00	19,20	22,40	25,60	28,80	32,00	35,20	38,40	kW	800W
<b>625 (642)</b>	2,50	3,75	5,00	6,25	7,50	8,75	10,00	11,25	12,50	13,75	15,00	kW	250W
	4,00	6,00	8,00	10,00	12,00	14,00	16,00	18,00	20,00	22,00	24,00	kW	400W
	6,00	9,00	12,00	15,00	18,00	21,00	24,00	27,00	30,00	33,00	36,00	kW	600W
<i>BSI only</i>	8,00	12,00	16,00	20,00	24,00	28,00	32,00	36,00	40,00	44,00	48,00	kW	800W
<b>750 (767)</b>	3,00	4,50	6,00	7,50	9,00	10,50	12,00	13,50	15,00	16,50	18,00	kW	250W
	4,80	7,20	9,60	12,00	14,40	16,80	19,20	21,60	24,00	26,40	28,80	kW	400W
	7,20	10,80	14,40	18,00	21,60	25,20	28,80	32,40	36,00	39,60	43,20	kW	600W
<i>BSI only</i>	9,60	14,40	19,20	24,00	28,80	33,60	38,40	43,20	48,00	52,80	57,60	kw	800W
<b>875 (892)</b>	3,50	5,25	7,00	8,75	10,50	12,25	14,00	15,75	17,50	19,25	21,00	kW	250W
	5,60	8,40	11,20	14,00	16,80	19,60	22,40	25,20	28,00	30,80	33,60	kW	400W
	8,40	12,60	16,80	21,00	25,20	29,40	33,60	37,80	42,00	46,20	50,40	kW	600W
<i>BSI only</i>	11,20	16,80	22,40	28,00	33,60	39,20	44,80	50,40	56,00	61,60	67,20	kw	800W
<b>1000 (1017)</b>	4,00	6,00	8,00	10,00	12,00	14,00	16,00	18,00	20,00	22,00	24,00	kW	250W
	6,40	9,60	12,80	16,00	19,20	22,40	25,60	28,80	32,00	35,20	38,40	kW	400W
	9,60	14,40	19,20	24,00	28,80	33,60	38,40	43,20	48,00	52,80	57,60	kW	600W
<i>BSI only</i>	12,80	19,20	25,60	32,00	38,40	44,80	51,20	57,60	64,00	70,40	76,80	kw	800W



ACCESSORIES FOR ASSEMBLY

EBO	REO	MPO	MBO
aluminium casing for radiator assembly	reflected made of polished stainless steel	stainless steel profiles used for HLS and IRS radiator assembly	mounting plates used for 122x122mm radiator assembly
 EBO/100 L=1010mm  EBO/75 L=760mm  EBO/50 L=510mm  EBO/25 L=260mm	 REO/250 L=250mm  REO/125 L=125mm	 MPO L=250mm  MPO/2 L=125mm	 EBO/500 L=500mm  EBO/375 L=375mm  EBO/250 L=250mm

Flexible strip heaters

Strip heaters (cables) are primarily used for freeze protection, temperature drop prevention, or are used to maintain the medium's temperature. The most common application of strip heaters is to ensure the appropriate temperature for liquid or other material inside pipes. Strip heaters render them unaffected by external conditions, which ensures a free flow inside pipes and tanks. After the necessary conditions are met, these heating systems may also be installed inside pipes and in pipelines. Strip heaters are used in a variety of industries, such as: chemical, petrochemical, agriculture and food processing, paper making, construction, automotive, transport, refrigeration and more. The systems are even used in complex industrial installations, also in explosion risk zones. The advantage of strip heaters is in their long life, reliability, quick and convenient assembly, no overheat and option to cut to any lengths, no periodic maintenance requirement and low operation costs.

Self-limiting, parallel strip heaters are not fitted with resistance heating elements, but with plastic with graphite admixture subject to appropriate processing, which reacts with the surrounding temperature by changing the resistance (and heating power) depending on the temperature on the surface of the strip. Self-regulating strip heaters do not overheat or burn even where two sections are in contact.

	FSG	FST	FSV	FSX
Wattage at [W/cm <sup>2</sup> ] 10°C	10, 15, 25, 31	10, 16, 25, 31, 40	17, 31, 45, 60	17, 31, 45, 60
Permitted working temp. [°C]	65	65	110	120
Permitted max. temp. [°C]	85	85	135	200
Earth screen	none or copper zinc plated	none or copper zinc plated	none or copper zinc plated or stainless steel	none or copper zinc plated or stainless steel
External jacket	none or PVC	none, PVC or fluoropolymer	none or fluoropolymer	none or fluoropolymer
Ex certificate		Yes	Yes	Yes

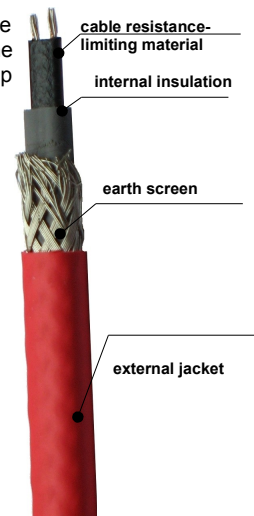

	TTM	TTR	TTS	TTX	TTWH
Wattage at 5°C [W/cm <sup>2</sup> ]	11, 17	10, 15, 25, 33	10, 15, 20, 25, 30, 45, 60	16, 32, 49, 65, 82, 98	33
Permitted working temp. [°C]	65	65	120	190	80
Permitted max. temp. [°C]	85	85	200	240	90
Earth screen	copper zinc plated	copper zinc plated	copper zinc plated	copper zinc plated	copper zinc plated
External jacket	PVC	PVC or fluoropolymer	none or fluoropolymer	none or fluoropolymer	PVC
certyfikat Ex		Yes	Yes	Yes	

**Parallel** heating cables are supplied in parallel, which results in hot zones having constant wattage, as a result of which, if damage occurs, only a given section stops working, while other still emit heat. This makes the strip very functional and handy in a number of applications. Parallel cables can be cut to the required length.

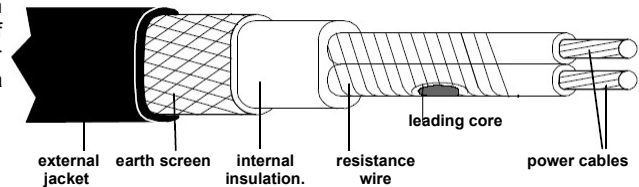

	TTCM					FTSH			FTTH			FTC	FTSO		
Wattage at 5°C [W/cm <sup>2</sup> ]	10	15	20	30	40	20	30	40	20	30	40	30	25	40	50
Max. perimeter length [m]	145	110	95	78	65	140	120	100	140	120	100	100	65	50	44
Temperature retention to [°C]	150					150			150			90			
Maximum working temp. [°C]	225					200			200			105			
Internal insulation	silicon					silicon			fluoropolymer			elastomer	silicon		
Earth screen	copper zinc plated					none or copper zinc plated or stainless steel			none or copper zinc plated or stainless steel			none	none or copper zinc plated		
External jacket	silicon					none or silicon			none or fluoropolymer			PVC	none		
Notes	universal application, industry and refrigeration					minimum working temperature -70°C			high resistance to chemicals			to heat chutes	in refrigeration		

**Resistance** strip heaters generate heat during current's passage through the resistance component. The heat is generated based on the electric energy loss to the benefit of heat energy. They are typically used in industrial and refrigeration applications, in machines and equipment, whenever protection against freezing is required, or where a specified temperature needs to be maintained.



	KYCY	C1S	C1ST
Maximum output wattage	25 W/m	30 W/m	30 W/m
Supply voltage	max 500V	max 600V	max 600V
Min. surface temperature	- 30 °C	- 70 °C	- 70 °C
Max. surface temperature	80 °C	200 °C	200 °C
Resistance type series [Ω/m]	0.058, 0.078, 0.14, 0.17, 0.24, 0.34, 0.47, 0.65, 1.00, 1.47, 1.90, 2.90, 4.00, 8.00, 18.00	12, 18, 25, 40, 60, 80, 110, 150, 180, 200, 250, 280, 360, 480, 800, 1000	12, 18, 24, 32, 40, 56
Structure	internal silicon insulation, zinc plated copper screen with external PVC jacket	silicon insulation	silicon insulation with zinc plated copper screen
Diameter	6,5 ÷ 7,0 mm	2,5 ÷ 3,0 mm	3,5 ÷ 4,0 mm

## Silicon heating elements

### CHARACTERISTICS

Heating elements that are workable into any shape. They are marked by good heat receipt, which is related to an option of ideal match with the heated area. Virtually any shape enables the placement of the heating element in any location where it is needed. Glass fibre-reinforced silicon sheath ensures durability and dimensional stability, and the minimum insulation layer between the resistance wire and the heated part ensures quick and effective heat transfer.

### TECHNICAL DATA

<b>Maximum dimensions</b>	915 x 3050 mm
<b>Thickness</b>	1,4 mm
<b>Weight</b>	0,24 g/cm <sup>2</sup>
<b>Maximum voltage</b>	600 V
<b>Maximum working temp.</b>	260 °C
<b>Minimum ambient temp.</b>	- 60 °C
<b>Surface load</b>	recommended: 0,8 W/cm <sup>2</sup> maximum: 1,2 W/cm <sup>2</sup> 4,5 W/cm <sup>2</sup> (required temp. control)

### APPLICATION

- Frost protection
- Catering equipment
- Medical devices
- Vulcanizing presses
- heating of the surface of machines and equipment, barrels, boilers, tanks, pipes, valves, pumps, etc.

### MANUFACTURE VERSIONS

**Teflon-insulated terminals** - standard connection by copper wires in 305 mm Teflon insulation (or as needed), resistant to 200°C at 600V.

**Silicon-insulated connections** - for increased protection against moisture, the connection between the power cords and heating elements is insulated with silicon rubber resistant to 150°C at 600V.

**Extra Teflon** - connection from the centre of the heating mat by copper wires in Teflon insulation, any length, resistant to 200°C at 300V.

**Holes, cut-outs and incisions** - we offer heating mats with custom holes, cut-outs and incisions to meet specific customer requirements.

**Profiled heating elements** - many three-dimensional shapes, such as cylinders, cones, cubes and other can be manufactured to individual orders. Semi-rigid shapes that adapt to the required shapes.

### ASSEMBLY METHODS

**Self-adhesive surface** - for quick and convenient installation. This assembly method is not recommended for curved surfaces or for heaters whose wattage is above 0.8 W/cm<sup>2</sup> and the working temperature in excess of 205°C.

**RTV adhesive, surfactant, vulcanizing at room temperature** - for stronger bonding. Components so assembled are ready to use after 48 hours. Resistant to temperatures 205°C or 260°C.

**Silicon binder set** - two-ingredient pack, contains resins and hardener, which mix very well and can easily be applied with a brush. Withstands temperatures up to 175°C.

**Mechanical tensioners** - they are recommended when the silicon heating element is to be used in many places and moved. Other mechanical tensioners include snaps, rings and Velcro.

### TEMPERATURE CONTROL

We can fit a number of temperature sensors that work with silicon heating mats::

- uncontrolled thermostats
- controlled thermostats
- thermocouple or RTD PT100 sensor ①

Thermostats may be integrated with heating elements (they are contained in silicon) ②a) or ordered separately, which ensures direct control of the thermal process. ②b)

### Available thermostats:

Model	Temp. range °C (temp on / temp off)	Voltage	Max. wattage
T-10 ③ (uncontrolled)	50 ÷ 149 ±5	230V~	960 W
T-207 ② (uncontrolled)	4/13 ±4,4    16/24 ±4,4	230V~	1500 W
	35/43 ±4,4    63/71 ±4,4		
B-200-2 ④ B-200-3	40 ÷ 260 -5 ÷ 165	230V~	1500 W

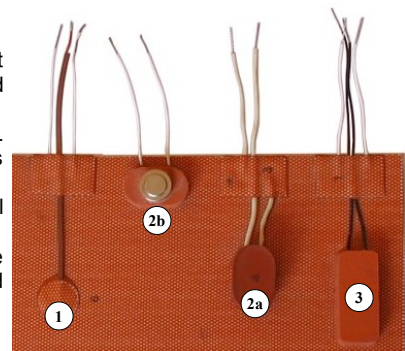
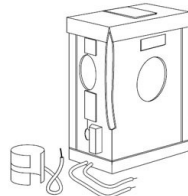
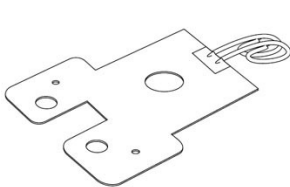
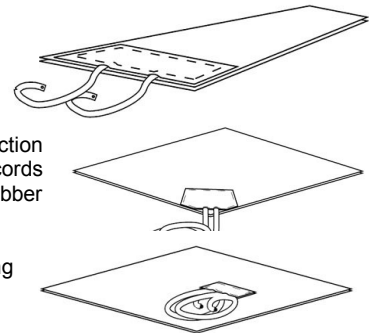
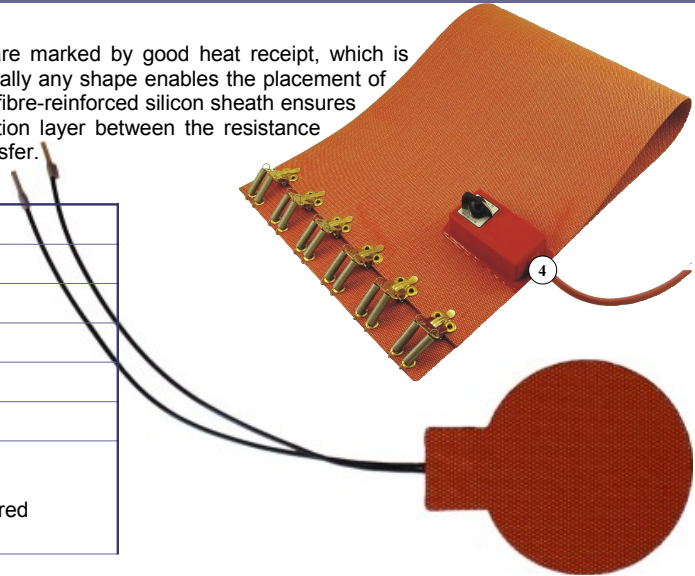

## Explosion-proof heating elements

### CHARACTERISTICS

In the chemical and petrochemical industry, when crude oil and natural gas are mined, in mining and many other industries where gases, vapours or mist is generated as a result of production, processing and storage of combustible materials. Together with oxygen present in the air, they form a dangerous mix, which may pose a threat to humans and cause substantial property damage.

The term "explosion" means a sudden chemical reaction of a material susceptible to ignition with oxygen, when a lot of energy is generated in the process.

Explosion takes place when the three conditions below are met simultaneously:

- 1) material susceptible to ignition (appropriate form and texture)
- 2) oxygen (from air)
- 3) source of ignition

In order to establish an atmosphere that is susceptible to explosion, the combustion material needs to be in the concentration zone.

If the concentration of combustible gases or fumes (fatty mixture) is too low, the explosion will not occur, but rather a slow burning reaction or no reaction at all. Explosive limits depend on the pressure of the environment and oxygen content in the air.

#### Potential sources of ignition:

- hot surfaces,
- electric sparks and arches,
- electrostatic discharges,
- atmospheric discharges (lightning),
- mechanical, frictional or impact sparks,
- electromagnetic radiation,
- ultrasounds,
- adiabatic compression (shock waves),
- ionising radiation,
- optical radiation,
- chemical reactions,
- open fire.

### CODES USED

Example codes for explosion-proof devices:

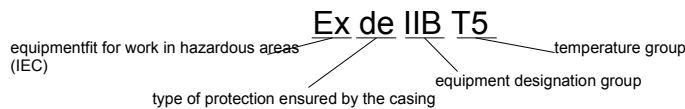

Equipment designation groups	
I	electric device for application in below ground installations
IIA	electric device for application in above ground installation where hazards due to propane may exist (e.g.: acetone, methanol and ethanol, acetone)
IIB	electric device for application in above ground installations where hazards due to ethylene may exist (e.g.: ethylene, hydrogen sulphide)
IIC	electric device for application in above ground installations where hazards due to hydrogen or acetylene may exist (e.g.: acetylene, hydrogen, hydrazine, carbon disulphide)

Temperature groups	
Category code	Max. surface temp.
T1	450°C
T2	300°C
T3	200°C
T4	135°C
T5	100°C
T6	85°C

Type of protection used in a given casing	
Code	Protection
d	Flameproof
ia	Intrinsically safe (zone 0)
ib	Intrinsically safe (zone 1)
p	Pressurised apparatus
e	Increased safety
o	Oil immersion
q	Powder filling
m	Encapsulation
n	Zone 2
s	Special safety

Hazardous area classification, acc. to IEC	
Name of zone	Description
Zone 0	Area in which an explosive gas-air mixture is continuously present or present for long periods
Zone 1	Area in which an explosive gas-air mixture is likely to occur for short periods in normal operation
Zone 2	Area in which an explosive gas-air mixture is not likely to occur (and if it occurs it will only exist for a very short time)

## ROOM RADIATORS — EXPLOSION-PROOF

These radiators are used to heat up small offices, warehouses and other premises in the zone I or II and equipment group IIA, IIB or IIC.

### Characteristics:

- certificate of compliance with ATEX 94/9/EC
- light casing, ensuring IP66/67 protection level.
- designed for single-phase or three-phase supply,  $U_{max}$  750V,  $I_{max}$  56A
- available in the following temperature classes: T1-T6, ambient temperature  $-30^{\circ}\text{C}$ - $+50^{\circ}\text{C}$
- designed for floor or wall-mounting (additional assembly supports may be required)
- unalloyed steel or stainless steel casing
- optionally, room thermostats are available in explosion-proof version

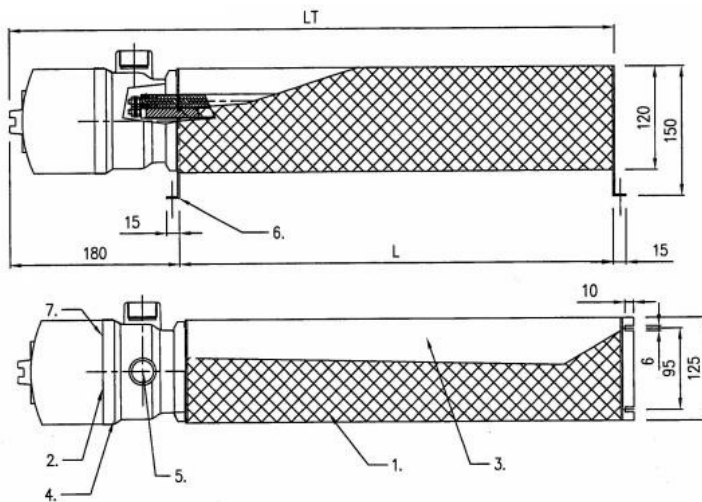

Working environment: calm air  $40^{\circ}\text{C}$

1. Zinc-plated carbon steel or stainless steel sheath
2. Thermostat with automatic resetting  $0 + 120^{\circ}\text{C}$  for overheat control
3. Tubular radiators  $\varnothing$  16 mm
4. Junction box IP 65 (ATEX)
5. Two  $1/2''$  GK seal wires  
( $1 \times 1/2''$  GK i  $1 \times 3/4''$  GK for 3kW)
6. Zinc-plated carbon steel or stainless steel mounting
7. Temperature limited with manual internal resetting  $100^{\circ}\text{C}$

Wattage [W]	Voltage [V]	dimensions		temp class
		L [mm]	LT [mm]	
500	230/1N	325	505	T4
1000	400/230/3N	575	755	T4
1500	400/230/3N	825	1005	T4
2000	400/230/3N	1075	1255	T4
3000	400/230/3N	1475	1655	T4

### Typical applications

- aircraft workshop hangars
- fuel supply points
- chemical works,
- offshore installations
- battery stores
- gas installations
- containers
- crane and other cabins





**IMMERSION HEATING ELEMENTS – EXPLOSION-PROOF**

Units made of tubular heating elements are designed for open tank installations, process baths, engine oil sumps, pressure vessels and similar equipment located in hazardous Zone 1 and Zone 2 - gas group IIA, IIB or IIC. The heaters can be used to heat up all non-aggressive liquids and gases.



**Characteristics**

- maximum voltage - up to 750V;
- maximum current - up to 56A;
- certificate of compliance with ATEX 94/9/EC
- the head made of aluminium cast with the maximum of two cable terminals and a bolted, threaded cover for terminals (certificate Eexd IIC T4-T6, with an option for T3-T6 for the version of the casing with terminals detached from the process terminal connection). Protection level IP65
- up to 3 heating elements in the unit, sheathing for copper heaters, unalloyed steel, Inconel or Incoloy alloys or stainless steel heaters
- head or threaded flange made of any material - dimensions, thread and tolerances as per customer requirements
- standard version is furnished with the heating element excessive temperature surge protection, optionally, a wide selection of temperature sensors (thermostats, thermocouples, RTD)
- ability to work in ambient temperatures (down to - 30°C)
- designed for horizontal mounting; upright mounting available on special order.

Wattage at 230/400V supply	Connection method	Length of immersed section	Heater material	Head material	Thread
0,5 kW	one - phase	280 mm	Incoloy 825	brass	1 1/4"
6 kW	three - phase	406 mm		brass	2"
2 kW	one - phase	590 mm	brass or stainless steel (316)	brass	2"
1 kW	one - phase	280 mm		brass or stainless steel (316)	2 1/4"
2 kW	one - phase	280 mm		brass or stainless steel (316)	2 1/4"
3 kW	three - phase	280 mm		brass or stainless steel (316)	2 1/4"
3 kW	three - phase	762 mm		brass or stainless steel (316)	2 1/4"
6 kW	three - phase	406 mm		brass or stainless steel (316)	2 1/4"
6 kW	three - phase	762 mm		brass or stainless steel (316)	2 1/4"
9 kW	three - phase	406 mm		brass or stainless steel (316)	2 1/4"
9 kW	three - phase	584 mm		brass or stainless steel (316)	2 1/4"
9 kW	three - phase	660 mm		brass or stainless steel (316)	2 1/4"
12 kW	three - phase	584 mm		brass or stainless steel (316)	2 1/4"
12 kW	three - phase	838 mm		brass or stainless steel (316)	2 1/4"

**EXPLOSION-PROOF IMMERSION HEATERS WITH A MOUNTING FLANGE**

Explosion-proof immersion electric heaters, certified for use in hazardous atmospheres in zone 1 and manufactured to the customer specification.

**Characteristics:**

- wattage up to 1000 kW
- voltage up to 750V;
- ATEX Ex 11 2 G/D approval
- EExd certificate, Zone 1, gas group II, A, B, C
- Class I, Div 1, gas group B, C, D certificate
- junction box with protection level IP 66/67
- temperature classes T1-T6
- designed and certified to use at extremely low and high temperatures (e.g. the Arctic and Middle East)
- the heating elements have a special sealing to prevent moisture ingress
- heating elements can be replaced at the place of incorporation without the need to use specialty tools
- heating elements made of a wide range of steel alloys (Incoloy 800/825, Inconel 600/625, stainless steel 316/316L, stainless steel 321 and other)
- Maximum immersion depth: 3665mm
- Nominal flange diameter range: 150 ÷ 1000 mm

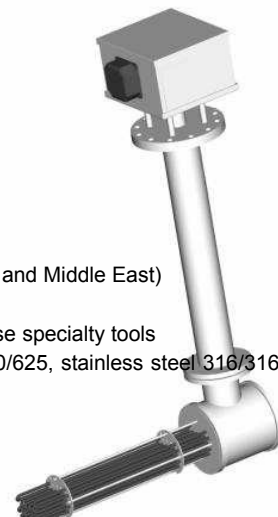

**EXPLOSION-PROOF IMMERSION HEATERS – L-SHAPED**



Immersion heaters are an ideal solution to use inside tanks located in hazardous Zone 1 or Zone 2. The structure of the heater provides for the horizontal placement of the components, which is conducive in the case of a low liquid level, and its upright mounting enables the fitting of the junction box above the upper lid of the vessel. The structure makes the heater perfect for underground tank heating.

## Temperature sensors

Temperature sensors enable a precise temperature reading in virtually any working environment. We offer different types of thermocouples and resistance-based sensors. Thermocouples are currently the most broadly used temperature sensors in the industry, they are marked by the shortest response to the temperature change and may be used for a broad range of temperatures (up to over 2000°C). The advantages of resistance sensors are their stability, precision and repeatability of measurements.

	Resistance sensors	Thermocouples
<b>Measuring device</b>	Pt100 (standard) - 2 x Pt100 Pt500 - 2 x Pt500 Pt1000 - 2 x Pt1000	Type K, Type J (standard) Type N, Type S, Type R, Type B hot junction insulated or integrated with the casing
<b>Internal wire</b>	2 wires (standard), 3 and 4- wires	2 wires
<b>Precision class</b>	B- for all versions A - to be used with 3 and 4 wires (only Pt100 and Pt500)	class 1 and 2 (J,K, R,S, N) class 2 and 3 (B)
<b>Primary measurement range (depends on sensor structure)</b>	-50 ÷ 400 °C (for Pt100, Pt500, Pt1000) -50 ÷ 700 °C (for Pt100)	0 -760 °C (type J) 0 -1250 °C (type K) 0 - 1600 °C (type S,R) 600 - 1700 °C (type B)
<b>Sheath material</b>	brass stainless steel 1H18N9T (1.4541) heat resisting steel H25N20S2 (1.4541) INCONEL® 600 alloy ceramic mullite 610, corundum 799 (Al <sub>2</sub> O <sub>3</sub> 99,7%) option to use external Teflon coating	
<b>Protective tubing diameters (depending on the sensor structure)</b>	Ø1, Ø1.5, Ø2, Ø3, Ø4, Ø5, Ø6, Ø8, Ø10, Ø12, Ø14, Ø20, Ø22 mm and others (steel) Ø5, Ø8, Ø10, Ø15, Ø22, (ceramic)	
<b>Length of sheath</b>	10 ÷ 2000 mm	
<b>Types of heads</b>	MA, NA, B (aluminum alloy) NS (polyamide)	
<b>Types of stubs</b>	- permanently fixed (welded) and slidable (to freely select the working length of the sensors) - two-section version using bayonet mounting, allowing a quick replacement of the sensors in their measuring locations - material: steel 1H18N9T or brass M58, nickel-plated - threads: 3/8"; 1/2"; 3/4"; M8x1; M10x1; M12x1; M14x1.5; M20x1.5; M27x2 or others	
<b>Types of connection cables</b>	Silicon insulation (up to 180 °C): 2x0.25; 3x0.25; 4x0.22 [mm <sup>2</sup> ] Silicon insulation, steel braid: 3x0.25 [mm <sup>2</sup> ] Teflon insulation (250 °C): 2x0.20; 3x0.20; 4x0.20 [mm <sup>2</sup> ] glass fibre insulation, steel braid (400°C): 2x0.22; 3x0.22; 4x0.22 [mm <sup>2</sup> ]	
<b>Accessories</b>	head measuring transducers, grips, expansion joints, junction boxes, compensating leads, Teflon coating	

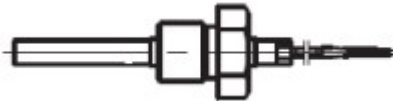
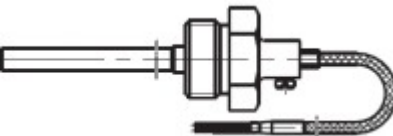

### WIRED SENSORS

Type	Drawing	Characteristics
PL PLT		basic sensor type, sensor Pt100, Pt500, Pt1000, Fe-CuNi /J/, NiCr-Ni /K/ stainless steel sensor Ø3, Ø4, Ø5, Ø6, Ø8 mm maximum temperature: 400 °C
PP PPT		sensor with welded threaded stub sensor Pt100, Pt500, Pt1000, Fe-CuNi /J/, NiCr-Ni /K/ stainless steel sensor Ø3, Ø4, Ø5, Ø6, Ø8 mm stub thread: M8x1, M10x1, M12x1, M14x1.5, M20x1.5, G1/4", G1/2" maximum temperature: 400 °C
PF PFT		sensor with additional stainless steel sheath, with a welded threaded stub sensor Pt100, Pt500, Pt1000, Fe-CuNi /J/, NiCr-Ni /K/ sensor/sheath of stainless steel Ø5/Ø6, Ø5/Ø7, Ø6/Ø8 mm stub thread: M14x1.5, M20x1.5, G1/2" or other maximum temperature: 400 °C
PU PUT		jacket sensor in mineral insulation, the structure enables its free bending provided that the minimum radius of 3x diameter is kept sensor Pt100, Pt500, Pt1000, Fe-CuNi /J/, NiCr-Ni /K/ stainless steel or Inconel 600 alloy sensor Ø1, Ø1.5, Ø2, Ø3, Ø4.5, Ø6 mm maximum temperature: 1200 °C

Type	Drawing	Characteristics
PD PDT		surface temperature sensor (abutting), sensor Pt100, Pt500, Pt1000, Fe-CuNi /J/, NiCr-Ni /K/ stainless steel sensor and hot junction of the thermocouple soldered to the bushed cable end or brass surface maximum temperature: 400 °C
PC		temperature sensor for pipeline surfaces and ventilation ducting sensor Pt100, sensor sheath made of brass with the radiator increasing heat receipt areas maximum temperature: 250 °C
PX PXT		temperature sensor for machines and equipment, mounted with a slidable bayonet mounting, with M12x1 threaded stub sensor Pt100, Pt500, Pt1000, Fe-CuNi /J/, NiCr-Ni /K/ nickel-plated brass sheath sheath finish flat, circular or conical maximum temperature: 400 °C
PXP		temperature sensor for machines and equipment, mounted with a slidable bayonet mounting, with M12x1 threaded stub sensor Pt100, Pt500, Pt1000, stainless steel sheath Ø4, Ø5, Ø6 mm sheath finish flat, circular or conical, maximum temperature: 400 °C
PXPT		temperature sensor for machines and equipment, mounted with a slidable bayonet mounting, with M12x1 threaded stub sensor Fe-CuNi /J/, NiCr-Ni /K/ stainless steel sheath Ø6 mm sheath finish flat, circular or conical, maximum temperature: 400 °C
PLX		sensor designed to measure temperature in highly caustic and aggressive alkali, salts and acids sensor Pt100 sensor sheath made of 1.4541 (1H18N9T) steel, covered with softened, heat resistant PVC or Teflon coating maximum temperature: 100 °C

**HEAD SENSORS**

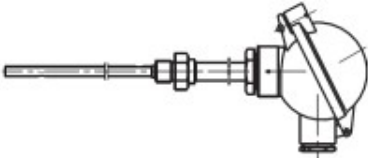
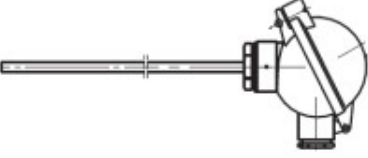
Type	Drawing	Characteristics
GL GLT		basic sensor type, sensor Pt100, Pt500, Pt1000, Fe-CuNi /J/, NiCr-Ni /K/ stainless steel sensor Ø6, Ø8 mm aluminium head NA IP65 maximum temperature: 700 °C
GLUT		straight or angular sensor, sensor Fe-CuNi /J/, NiCr-Ni /K/ 1.4841 heat-resisting steel sheath, Ø20 mm aluminium head B IP55 maximum temperature: 1150 °C (for thermocouple NiCr-Ni)
GP GPT		sensor with threaded stub welded right next to the head sensor Pt100, Pt500, Pt1000, Fe-CuNi /J/, NiCr-Ni /K/ stainless steel sensor Ø6, Ø8 mm aluminium head NA IP65 maximum temperature: 150 °C

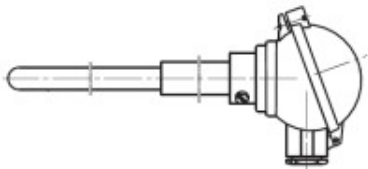
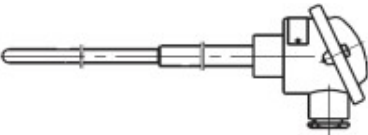
Type	Drawing	Characteristics
GN GNT		sensor with threaded stub welded further from the head sensor Pt100, Pt500, Pt1000, Fe-CuNi /J/, NiCr-Ni /K/ stainless steel sensor Ø6, Ø8 mm aluminium head NA IP65 maximum temperature: 400 °C
GLP GLPT		jacket sensor in mineral insulation, the structure enables its free bending provided that the minimum radius of 3x diameter is kept sensor Pt100, Pt500, Pt1000, Fe-CuNi /J/, NiCr-Ni /K/ stainless steel or Inconel 600 alloy sensor Ø1, Ø1.5, Ø2, Ø3, Ø4.5, Ø6 mm aluminium head NA IP65 maximum temperature: 1200 °C
GLX		sensor designed to measure temperature in highly caustic and aggressive alkali, salts and acids sensor Pt100 sensor sheath made of 1.4541 (1H18N9T) steel, covered with softened, heat resistant PVC NS IP54 head maximum temperature: 100 °C
GTT-22		ceramic sheath sensor, Ø15mm retaining sheath made of heat-resisting steel, Ø22mm sensor PtRh10-Pt /S/, PtRh30-PtRh6 /B/, PtRh13-Pt /R/, NiCr-Ni /K/ aluminium head DA IP65 maximum temperature: 1600 °C
GTT-42		sensor with ceramic sheath Ø5, Ø8, Ø10mm – 99.7% Al <sub>2</sub> O <sub>3</sub> retaining sheath made of heat-resisting steel, Ø10mm / Ø15mm sensor PtRh10-Pt /S/, PtRh30-PtRh6 /B/, PtRh13-Pt /R/, NiCr-Ni /K/ aluminium head B IP55 maximum temperature: 1600 °C

**OTHER SENSORS**

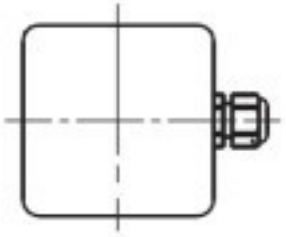
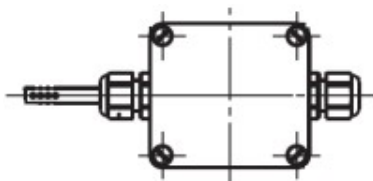
Type	Drawing	Characteristics
POP POG		temperature sensor with perforated tip to work in ventilation ducts aluminium head or cabled version retaining stainless steel sheath Ø6 mm sensor Pt100 maximum temperature: 500°C (head version) 150°C (cabled version)
POW		ambient temperature sensor in ABS IP20 casing for wall mounting in rooms sensor Pt 100, Pt500, Pt1000, Ni100, Ni1000 dimensions: maximum temperature: 60°C
POZ		ambient temperature sensor in IP67 polycarbonate casing designed for assembly in rooms or outdoors sensor Pt 100, Pt500, Pt1000, Ni100, Ni1000 maximum temperature: 85°C

**SENSORS – ACCESSORIES**

**Threaded grips for sensor mounting - UG type**

used for installing sensors that are not fitted with additional threaded connectors and flanges; their structure enables the mounting of the sensor sheath in any location. Threaded grips ensure tightness at the pressure not greater than 0.1Mpa

- **Material:** unalloyed steel or stainless steel.
- **Thread:** M10x1, M12x1, M14x1.5 or other
- **Sensor diameter:** 3 ÷ 20mm



**Steel and ceramic sheaths**

- smooth and with external and/or internal threads
- made of stainless steel (type **OG**): diameters Ø4 ÷ Ø14
- made of ceramics (type **OC**): diameter Ø15

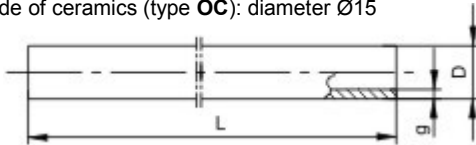

**Compensating leads**

- to connect thermoelectric sensors to measuring equipment,
- designed for thermocouples J, K, R/S, T, B, N
- silicon or glass fibre core insulation
- silicon or glass fibre cable coating with an optional steel braid
- core sections: 2x0,22mm<sup>2</sup>, 2x0,5mm<sup>2</sup>, 2x0,75mm<sup>2</sup>, 2x1,5mm<sup>2</sup>

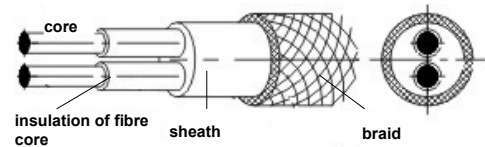
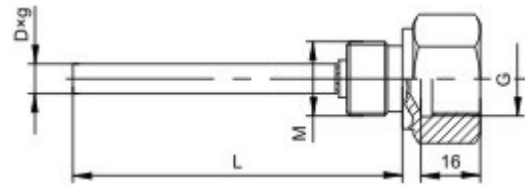

**Plugs and sockets**

- to connect thermoelectric and resistance sensors
- standard and mini version
- working temperature range: -20° ÷ C220°C



Code	Plug	Socket
<b>Thermocouples J, K, S and N</b> (insert thermocouple type where there is an asterisk *)		
Mini version	SMPW – * – M	SMPW – * – F
Standard version	OSTW – * – M	OSTW – * – F
<b>Pt100, Pt1000 resistance sensors</b>		
Mini version	MTP – U – M	MTP – U – F

**Temperature transducers**

- mounting in the head (Ø44mm) or on DIN 35mm rail
- input: thermoelectric, resistance or 0÷50mV voltage sensors
- output: 4÷20mA
- power supply: 15÷30V DC
- transducing precision: 0.2% of the range for Pt100 and mV, 0.3% of the range for thermocouples
- version with and without input/output plating insulation
- PC-based configuration of the transducer using RS232 and an optional TxConfig set



Description / Code	head mounting	rail mounting
no plating insulation for input/output	<b>TxBLOCK</b>	<b>TxRail</b>
with plating insulation for input/output	<b>TxIsoBlock</b>	<b>TxIsoRail</b>



## Control equipment

### THERMOSTATS WITH A CAPILLARY TUBE

Thermostatic controllers are designed to control electric devices (heaters, blowers) in the temperature control systems in a variety of working environments (water, oil, air)

Also, we offer threaded seal wires mounted on the capillary tube and facilitating the assembly of the thermostat



Model	ST9	HU/5-90	HU/30-110	ST12	ST22	HU/50-220	ST30	HU/50-320	TR2	GLTH0350
Working range	0 ÷ 90 °C	5 ÷ 90 (±4) °C	30 ÷ 110 (±4) °C	30 ÷ 120 °C	50 ÷ 220 °C	50 ÷ 220 (±8) °C	50 ÷ 300 °C	50 ÷ 320 (*10/2) °C	-35 ÷ 35 °C	5 ÷ 77(±4) °C
Hysteresis	3 ± 2°C	4 ± 2°C	4 ± 2°C	3 ± 2°C	8 ± 2°C	10 ± 2°C	8 ± 2°C	8 ± 2°C	2 ± 1°C	~4 °C
Maximum sensor temperature	99 °C	105 °C	125 °C	130 °C	240 °C	250 °C	315 °C	350 °C	55 °C	107 °C
Sensor material and diameter	brass Ø6,5 mm	stainless steel Ø6 mm	stainless steel Ø6 mm	brass Ø6,5 mm	brass Ø6,5 mm	stainless steel Ø3 mm	stainless steel Ø3 mm	stainless steel Ø3 mm	brass Ø6,5 mm	cooper Ø6 mm
Length of capillary tube	900 mm	1250 mm	935 mm	900 mm	900 mm	935 mm	900 mm	935 mm	1500 mm	277 ±25 mm
Maximum current of contacts	16(5)A 250V~ 10(1)A 400V~	20(5)A 250V~	20(5)A 250V~	16(5)A 250V~ 10(1)A 400V~	16(5)A 250V~ 10(1)A 400V~	20(5)A 250V~	16(5)A 250V~ 10(1)A 400V~	20(5)A 250V~	16(5)A 250V~ 10(1)A 400V~	20(5)A 250V~ (SPST)
Casing dimensions	~ 45 x ~40 x ~35 mm scaled knob and metal frame in the package, casing prot. level IP00									~42 x ~30 x ~32 mm

### THERMOSTATS WITH A CAPILLARY TUBE – THREE-PHASE

Thermostats designed to control temperature in heating equipment. They enable direct control of three-phase circuits.

Model	R33-85	R33-110	R33-300	R33-40	TC-1R31/50-300
Working range	0 ÷ 85 °C	30 ÷ 110 °C	50 ÷ 300 °C	-40 ÷ 40 °C	50 ÷ 300 °C
Hysteresis	5 ± 1°C	6 ± 1°C	10 ± 2°C	5 ± 1°C	10 ± 4°C
Maximum sensor temperature	120 °C	135 °C	320 °C	65°C	345 °C
Sensor material and diameter	brass Ø6 mm	brass Ø6 mm	stainless steel Ø3,7 mm	brass Ø6,5 mm	stainless steel Ø4 mm
Length of capillary tube	1500 mm				1500 mm
Maximum current of contacts	16A 400V triple DPST contact, normally open				
Casing dimensions	~45 x ~40 x ~35 mm stopień ochrony IP00				~ 50 x ~50 x ~40 mm scaled knob and metal frame in the package



Model	43.005	43.006
TR controller settings range	65°C (±8K) ÷ 200°C (±6K)	30°C (±5K) ÷ 75°C (±3K)
Activation temperature for temperature limiter STB	240°C (-16K)	98°C (-8K)
Maximum TR/STB sensor temperature	275 °C / 370°C	140 °C / 170°C
Length of capillary tube TR/STB		520 ± 50mm / 390 ± 50mm
Maximum current of contacts	20A 400V~	20A 400V~
Casing protection level	IP00	IP00

Universal, three-phase thermostat with a temperature limiter. Embedded non-automatic temperature limiter protects the device against excessive, uncontrolled temperature rise. Reactivation of the thermostat after the limiter is activated is possible following the manual reset of the device (by pressing the red button on the casing).

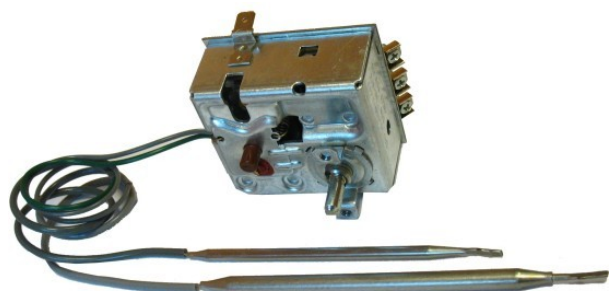

### SAFETY LIMIT THERMOSTAT

Thermostats that protect the devices against excessive temperature rises. The temperature rise in excess of the set disconnect temperature separates contacts in the power supply circuit. Reactivation is only possible mechanically, by pressing the "reset" button in the limiter body after the sensor cools down.

We offer limiters set to temperatures from the 20 - 320°C range in one- and three-phase versions..



Model	<b>STB 89.11</b>
Control range	95 ... 120 °C
Precision	3±5 °C
Maximum sensor temperature	145 °C
Sensor material and diameter	brass Ø6,5 mm
Length of capillary tube	3500 mm
Maximum current of contacts	16A 250V~ SPtūsc ... hied contact
Casing protection level	IP00
Certificates	VDE, CE, DIN CERTCO

### ENCASED THERMOSTATS

Model	TSC-093	TSC-095	TU-10B	TUSC
Type	wall-mounted	wall-mounted	immersion	abutting
Setting range	- 35 ÷ 35 °C	- 35 ÷ 35 °C	0 ÷ 90 °C	
Precision	3 °C	3 °C	3 °C	
Hysteresis	<5°C	<5°C	5°C	
Sensor type	sensor Ø6x120 mm with a capillary tube 1500mm	sensor Ø7x70 mm mounted directly on the casing side wall	sensor tube Ø8x100mm, threaded connection G1/2"	sensor is mounted on the back wall of the casing, assembly on 2/3-4" pipes with the spring supplied with the product
Maximum current	16(4)A 250V - 6(1)A 400V SPTD switched contact			
Protection level	IP44		IP40	
Casing dimensions (width x height x depth)	~ 60 x ~90 x ~35 mm		~40 x ~105 x ~55 mm	



### THERMOSTATS FOR HEATING ELEMENTS USED FOR WATER HEATERS

- one-phase bimetallic thermostats 250V 20A
- sensor tube length: 280mm
- easy direct assembly in the corresponding heating elements' heads (e.g. type [43.001](#))
- mounting to the head with 6.3 tabs, tab spacing of 28 mm



Model	Characteristics
43.004	Bimetallic thermostat with a non-automatic temperature limiter and manual reset; setting range 10 ÷ 60 °C (knob axis) activation temperature for temperature limiter: ~77 °C

TEMPERATURE CONTROLLERS WITH ANALOGUE SETTING



	BTC902	BTC404	SCL200 SCD200	SCL210E3 SCD210E3	SCL213E3 SCD213E3	ESM 3710	ESM 4410
Description	Simple-to-use devices for temperature control systems		Universal and cheap, microprocessor temperature controllers for heating or refrigeration equipment control				
Input	1x Pt100 sensor, or thermocouple J or thermocouple K (selectable when ordering)		PTC/NTC sensor (included)	1x Pt100 sensor, thermocouple J, thermocouple K (selectable when ordering)		PTC, PT100, thermocouple J, K (selectable when ordering)	
Output	1x relay 5A/230V~		1x relay 16A/230V~	1x relay 8A/250V~	3x relay 8A/250V~ (2 control thresholds + alarm)	relay 10A 250V~ or switched DC 12V/20mA	relay 7A 250V~ or switched DC 12V/20mA
Measuring range	0+100°C, 0+200°C, 0+300°C, 0+400°C, 0+600°C, 0+800°C, 0+1200°C		-50 ÷ 150°C with PTC sensor	-99 ÷ 999°C (for thermocouple K)		PTC (-50+150°C); PT100(50+400°C); J(0+800°C); K(0+999°C)	
Precision	±2% of the range	±1% of the range	±2% of the range	±1% of the range		±1% of the range	
Control mode	ON-OFF or proportional P		ON-OFF				ON-OFF
Hysteresis	1% of the range		adjustable				adjustable
Dimensions	48x48x86mm (BTC902)	96x96x55mm (BTC404)	type SCL: 75x33x63 mm, cut-out 71x29 mm type SCD: DIN rail, base: 70x90mm, panel: 70x45mm, overall depth: 60mm		77x35x59 mm panel cut-out 71x29mm		48x48x84 mm panel cut-out 46x46mm
Power supply	230V~ ±10%	90+260V~ or 16+48V=12+36V~	230V~ ±10% , ambient temperature: -10+50°C				230V~ +/-15% (optionally 12V=~/-, 24V=~/-)

UNIVERSAL TEMPERATURE CONTROLLERS WITH DIGITAL SETTING

	ESM 4420	ESM 4450, ESM 4950, ESM 9450	Watlow PM6 Express
Input	Universal: PT100, thermocouples J, K, T, R, S	Universal: Pt100, thermocouples current/voltage: 0/4...20mA, 0...10V, 0...5V, 0...50mV	Universal: Pt100, thermocouples; analogue: 0/4...20mA, 0...10V
Output	1x relay 5A 250V~ 1x12V 20mA SSR control	1x relay 5A 250V~ optionally up to 2 additional I/O modules	1 or 2 outputs: switched DC 22+32V= 40mA (SSR control); SSR 0,5A max 264V~; relay 5A 240V~ lub 30V=; hybrid relay 15A 24+240V~; voltage 0+10V=; current 4+20mA
Precision	+/-0,25% of the range	+/-0,25% of the range (for Pt100, thermocouples and analogue inputs)	+/-0,1% of the range
Sampling	330 ms	330 ms	100ms
Control mode	PID with auto-tune feature, ON-OFF with adjustable hysteresis		
Dimensions	48x48x84 mm panel cut-out: 46x46mm	ESM 4450: 48x48mm (panel cut-out 46x46mm) ESM 4950: 48x96mm (panel cut-out 46x92mm) ESM 9450: 96x48mm (panel cut-out 92x46mm)	54x54x102 mm panel cut-out 45x45mm
Power supply	230V~ +/-15% (optionally: 12V=~/-, 24V=~/-)	230V~ +/-15% or 24V=~/-	100-240 V~ 12-28 V=~/-
Additional features	-	<b>Smart I/O module system – available additional analogue and digital input/output units</b> <b>Output modules:</b> relay 3A 250V~; SSR 18V= 20mA; transistor 18V=, 40mA; current 0/4...20mA; <b>Input modules:</b> digital input; current input 0/4...20mA; current transformer input CT 0...5A; thermocouple or 0...50mV DC input; Pt-100 input; <b>8 steps profile control (Ramp&amp;Soak), motorized valve control, retransmission of process value</b> RS-232 (standard) or RS-485 (optional) serial communication with MODBUS RTU protocol.	



ESM4420  
ESM 4450



ESM4950



ESM9450



Watlow PM  
Express

### SOLID STATE RELAYS

Solid state relays (SSR) are used to activate power in electric circuits in dry contact. Next to traditional electromagnetic relays, these have become a standard in many machines.

The primary advantages of semi-conductor SSRs as compared to electromechanical systems are:

- very quick and reliable switching, ensuring long and defect-free operation
- no moving parts (greater reliability)
- protection against electromagnetic and radio interference

High activation frequency means that the minimum heating cycle is shortened, which, in effect, enables a more precise and reliable temperature control using controllers working in the PID mode.

### RJ1A SINGLE-PHASE SOLID STATE RELAY WITH AN INTEGRATED RADIATOR, FOR 35 MM RAIL MOUNTING

Characteristics:

- one-phase AC semiconductor contactor, switched at zero voltage
- option to do three-phase control by using 2 or 3 devices
- rated load currents: 20A, 30A, 45A, or 70A (AC51)
- integrated radiator ensures correct heat abstraction
- LED diode - activation indicator



		Model code			
Rated voltage	230 V AC	RJ1A23D20U	RJ1A23D30U	RJ1A23D45U	RJ1A23D70U
	600 V AC	RJ1A60D20U	RJ1A60D30U	RJ1A60D45U	RJ1A60D70U
<b>Maximum load current <math>T_a=25^{\circ}\text{C}</math></b>		<b>20 A</b>	<b>30 A</b>	<b>45 A</b>	<b>70A</b>
Minimum load current		350 mA	150 mA	150 mA	100 mA
Maximum leakage current		3 mA			
Maximum voltage drop		1,6 V			
<b>Control voltage</b>		<b>4 – 32 V DC</b>			
Maximum input current		12mA			
Working temperature		-30 ÷ 70°C			
Dimensions (height x width x depth)		102.6 x 22.5 x 103	102.6 x 45 x 103	102.6 x 90 x 103	

### RZ3A THREE-PHASE SOLID STATE RELAY

Characteristics:

- three-phase AC semiconductor contactor, switched at zero voltage
- rated load currents: 40A, 75A
- radiators ensure the correct heat dissipation (optional)
- LED diode - activation indicator



		Model code	
Rated voltage	400 V AC	RZ3A40D40	RZ3A40D75
<b>Maximum load current <math>T_a=25^{\circ}\text{C}</math></b>		<b>40A</b>	<b>75 A</b>
Minimum load current		150 mA	150 mA
Maximum leakage current		3 mA	
Maximum voltage drop		1,6 V	
<b>Control voltage</b>		<b>4 – 32 V DC</b>	
Maximum input current		23mA	
Working temperature		-30 ÷ 80°C	
Dimensions (h x w x d)		103 x 73.5 x 41	

### ACCESSORIES FOR SSRs

#### Radiators

These are needed owing to the significant heating of SSRs in regular work; the radiator should be selected to match the SSR's working environment and its current load

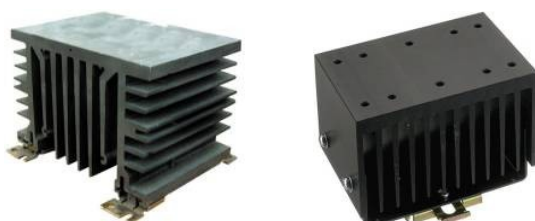

#### Fuses and fuse bases

ultra-quick fuses protect solid state relays against exceeding the permitted current values in the circuit, and against relay damage

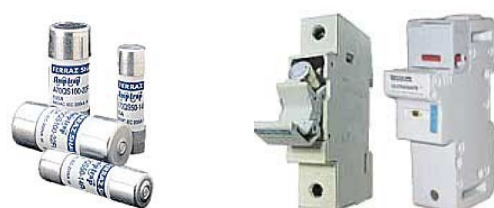



## TEMPERATURE CONTROL SYSTEMS

Complete control systems enclosed in boxes for a quick and smooth connection of power and heating elements.

Control boxes perform the following functions:

- permanent control and regulation of the process temperature,
- controlled activation of heating component relative to the temperature,
- status indication.

In typical configurations, the control system is composed of:

- digital temperature controller with the reading of the present process temperature and view of the set temperature,
- SSR or electromechanical relays,
- short-circuit protection systems,
- main switch,
- safety switch,
- indication of heating element section activation,
- distribution panel for the connection of heating elements and temperature sensors



## Ceramic connection blocks

Ceramic connection blocks are offered in two versions: C110/C111 ceramic and C220 (steatite) high temperature ceramic material. We offer both hole-less blocks and those with a mounting hole, as well as blocks to be mounted on the mounting rail. Our offer comprises both the simplest two-, three-, and four path ones, as well as specialty blocks having various shapes and up to eight connection paths. We can also produce non-standard shape blocks.

Type	Number of paths	Cross-section [mm <sup>2</sup> ]	Electrical data	Dimensions L/W/H [mm]	Constant working temp. [°C]
<b>C111, IEC 672-1 ceramic blocks, glazed porcelain with a mounting hole</b>					
43.038	2	1,5 - 6	450V / 24A	20 / 18 / 15	350
43.039	3	1,5 - 6	450V / 24A	33 / 18 / 15	350
43.045	2	1,5 - 6	450V / 24A	23 / 20 / 16	350
43.046	3	1,5 - 6	450V / 24A	36 / 20 / 16	350
43.040	4	1,5 - 6	450V / 24A	48 / 23 / 16	350
43.047	2	1,5 - 6	450V / 24A	20 / 21 / 18	350
43.041	2	2,5 - 10	450V / 32A	24 / 22 / 20	350
43.042	3	2,5 - 10	450V / 32A	39 / 23 / 20	350
43.043	2	2,5 - 16	450V / 57A	34 / 30 / 23	350
43.044	3	2,5 - 16	450V / 57A	52 / 30 / 23	350
<b>C111, IEC 672-1 ceramic blocks, glazed porcelain without mounting hole</b>					
43.036	1	1,5 - 6	250V / 24A	8 / 17 / 14	350
43.053	1	2,5 - 16	450V / 57A	15 / 30 / 23	350
43.026	3	1,5 - 6	250V / 24A	∅16 / 23 / M3	350
<b>C220, IEC 672-1 ceramic blocks, non-glazed with a mounting hole</b>					
43.021	2	2,5 - 10	230V / 20A	51 / 22 / 20	250
43.030	2	1,5 - 6	250V / 24A	21 / 18 / 15	350
43.031	2	2,5 - 10	450V / 32A	24 / 22 / 21	350
43.032	2	2,5 - 16	450V / 57A	34 / 30 / 23	350
43.033	3	1,5 - 6	250V / 24A	33 / 18 / 15	350
43.034	3	2,5 - 10	450V / 32A	38 / 22 / 21	350
43.035	3	2,5 - 16	450V / 57A	53 / 30 / 23	350
43.057	2	-	230V / 20A	40 / 32 / 21	400

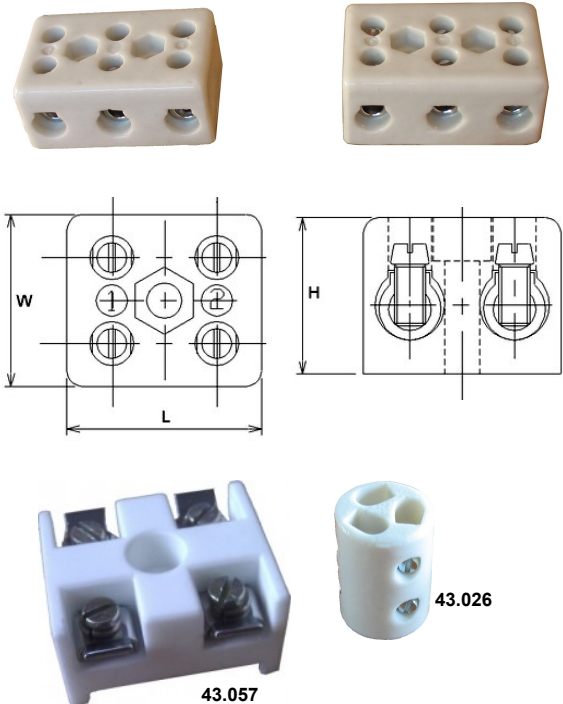



## Conductors in high-temperature resistant insulation

### SILICON INSULATED CONDUCTORS

Halogen-free silicon rubber insulation

Working temperature: **-60°C ÷ 180°C**  
 Peak temperature: **230°C**  
 Rated voltage: **450/750V**

#### Characteristics:

constant resistance during thermal shocks;  
 high resistance to aging in hot environments;  
 high resistance to weather factors: ozone, oxygen, UV;  
 minimum bend radius: 5x diameter,  
 available in multiple colours.

#### Applications:

home heating appliances, industrial installations, machines and equipment, urban lights



Core section	[mm <sup>2</sup> ]	0,75	1	1,5	2,5	4
Linear resistance at 20°C	[Ω/km]	26,7	20	13,7	8,21	5,09
Thickness of insulating layer	[mm]	0,6	0,6	0,6	0,7	0,8
Outer diameter	[mm]	2,4	2,5	2,8	3,4	4,2
Weight	[kg/km]	12	14	21	30,5	46,5

### TEFLON INSULATED CONDUCTORS

Working temperature: **-90°C ÷ 205°C**  
 Peak temperature: **220°C**  
 Rated voltage: **450/750V**

#### Characteristics:

high resistance to aggressive chemical environments;  
 high resistance to humidity and UV radiation;  
 high mechanical strength,  
 minimum bend radius: 5 x diameter;  
 available in multiple colours

#### Applications:

home wiring systems, hot and cold climate installations, aggressive environment installations (moisture, chemicals), installation whenever a close fit is necessary along with high mechanical strength



Core section	[mm <sup>2</sup> ]	0,75	1	1,5	2,5
Linear resistance at 20°C	[Ω/km]	26	19,5	13,3	7,98
Thickness of insulating layer	[mm]	0,2	0,25	0,3	0,3
Outer diameter	[mm]	1,05	1,25	1,45	1,9
Weight	[kg/km]	8	11	15,6	26,3

### GLASS FIBRE INSULATION CONDUCTORS

Silicon-varnished glass fibre insulation

### GLASS FIBRE INSULATION CONDUCTORS IN ADDITIONAL JACKET

Double glass fibre, silicon-varnished insulation

Working temperature: **-60°C ÷ 350°C**  
 Peak temperature: **380°C**  
 Rated voltage: **300/500V**

#### Characteristics:

high resistance to aggressive chemical environments;  
 high resistance to humidity and UV radiation;  
 high mechanical strength,  
 minimum bend radius: 5 x diameter;  
 available in multiple colours

#### Applications:

home wiring systems, hot and cold climate installations, aggressive environment installations (moisture, chemicals), installation whenever a close fit is necessary along with high mechanical strength



Core section	[mm <sup>2</sup> ]	Single insulation					Double insulation					
		0,5	0,75	1	1,5	2,5	0,5	0,75	1	1,5	2,5	4
Linear resistance at 20°C	[Ω/km]	180	115	92	61	42	180	115	92	61	42	27
Thickness of insulating layer	[mm]	0,6	0,6	0,6	0,6	0,6	0,7	0,7	0,8	0,8	0,8	0,8
Outer diameter	[mm]	2,1	2,25	2,5	2,6	3	2,4	2,7	2,75	2,9	3,7	4,2
Weight	[kg/km]	9,7	11,5	15	18,5	27,8	12	14,7	17	22	32	50