

BIG WHITE 2013

FOCUSED ON LIGHT

SLV®



Dear Customer,

we are presenting you our lamp collection 2013 and wish you much pleasure browsing through the catalogue.

We have used pictograms in this catalogue so that the important details can be recognized easily. A detailed explanation of these pictograms can be found at the end of this catalogue.

A significant part of the presented products in this catalogue is protected by trademark, industrial design, registered design or patents. The catalogue design as well as the design of photos, packaging and operating instructions are our intellectual property. Any violation of trade mark rights or the use of text and layout without our approval will be prosecuted.

All products of our range are subject to strict quality assurance and comply with the generally valid standards (CE).

Unless otherwise indicated, all weight and length specifications are specified in kg and cm.

Products with the sign ▼ are only available in limited quantities.

The pictures and descriptions in this catalogue serve only as an illustration and are without obligation in colour, shape, design and technical details. Subject to change without notice.

With the publication of this catalogue all prices in so far published lists and catalogues are no longer valid. Our standard terms and conditions of business apply. We do not accept opposing conditions of purchase.

The minimum order value amounts to € 15,-. For orders under a net-goods value of € 50,- we charge a small quantity surcharge of € 8,-.

The dispatch is generally carried out ex-works and cash in advance, so far other agreements have not been made. The sender carries the packaging costs. The dispatch is made by parcel service. Deliveries with overlength and heavy products have to be dispatched by a forwarding agency. Please note that some articles of our range have to be distributed on two separate parcels in order to avoid damages. This may lead to increased shipping costs.

Special made products are excluded from exchange and must always be ordered in writing.

Please specify the six-digit article number as well as colour and quantity when placing your order. This saves queries, time and speeds up the dispatch of your order.

Please also pay attention to our return guidelines and repair conditions, which can be found on our webpage www.slv.de. Returned goods can only be accepted if sent back carriage paid. This also applies for goods returned because of complaints. Bulbs are generally excluded from exchange. We particularly point out that for the storage of articles, which are returned for credit note, a restocking fee of 20% of the credit note value will be charged.

A lot of fun with the new catalogue wishes you

Your SLV-Team

For further information about our products please visit our product website www.slvbyslv.com

© Corporate Creative Center 2012

Advice by telephone:

Monday to Thursday
8.00 am - 5.00 pm

Friday
8.00 am - 2.30 pm

Export Phone: +49 - 2451 - 4833-355

Export Fax: +49 - 2451 - 4833-179

Export E-Mail: export@slv.de

Collection:

Monday to Thursday
8.00 am - 12.00 pm and 1.00 pm - 4.30 pm

Friday
8.00 am - 12.00 pm and 1.00 pm - 2.00 pm

Collection address:

SLV Elektronik GmbH
Logistic Center
Werkstr. 8-10
52531 Übach-Palenberg
Germany

Sales Assistance:

BIG WHITE 2013
Neutral English
Net Price

000393

BASIC PRODUCTS

004 - 225



Ambience	004 - 041
Plaster luminaires	042 - 045
Table and floor luminaires	046 - 051
Pendant luminaires	052 - 109
Wall and ceiling luminaires	110 - 225

STAGE FACTORY LINE® professional shop-lighting

226 - 227



Stage Factory Line®	226 - 227
---------------------	-----------

TRACK SYSTEMS

228 - 309

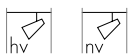

3Phase high-voltage track system	228 - 259
1Phase high-voltage track system	260 - 273
Easytec® II high-voltage track system	274 - 287
Linux Light® low-voltage track system	288 - 295
C-Track® low-voltage track system	296 - 297
Glu-Trax® low-voltage track system	298 - 299
Mini Alu-Track low-voltage track system	300 - 301
Apollo low-voltage track system	302 - 303
Wave low-voltage track system	304 - 305
Low-voltage rope system	306 - 309

SPECIAL PRODUCT SERIES

310 - 326



Display and rod luminaires	311 - 323
Floor cupboard luminaires	324 - 326

RECESSED LUMINAIRES

327 - 437

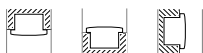

New Tria series	330 - 333
Aixlight® Mod and Flat series	334 - 335
Aixlight® Pro system	338 - 347
Horn series	348 - 351
Special recessed luminaires	352 - 363
LED recessed luminaires	364 - 381
Recessed luminaires low-voltage	382 - 403
Recessed luminaires high-voltage	404 - 431
Twister system	432 - 435

OUTDOOR

438 - 603



Light objects	442 - 446
Lamp series and floor lights	448 - 503
Wall and ceiling luminaires	504 - 537
Display lights	538 - 541
Spotlights	542 - 569
Recessed and surface mounted luminaires	570 - 603

DECORATIVE LIGHT

604 - 628



LIM® Light in Motion	605
LED Multifunction module	606
Ledi Light® Fibre Set LED	607
Mini LED module chain	607
PenLight®	608 - 609
Light bars	610 - 611
LED strips	612 - 628

ACCESSORIES AND BULBS

629 - 661

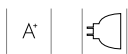

LED converters	630
LED controllers	631 - 634
LED drivers	635 - 636
LED power units 12V=/24V=	637 - 638
Ballasts	639
Conventional transformers	640 - 641
Electronic transformers	642 - 643
General accessories	643 - 645
General bulbs	648 - 652
LED bulbs	654 - 657
Energy-saving bulbs	658 - 661

INDEX

662 - 674



Index	662 - 674
-------	-----------

AMBIENCE







BISHADE

RESIDENTIAL LUMINAIRES



Bishade SL-1

Bishade TL-1



BISHADE TL-1 / SL-1



Socket/Bulb:
E27/AGL (excl.)
40W max.
or
E27/EnergySaver (excl.)
25W max.
up to max. length: 15 cm (155651)
up to max. length: 22 cm (155652)

Material:
Steel/textile/PS/imitation leather

Dimensions: (155651)
Product-Ø/H: 33/56 cm
Shade-Ø/H: 33/21 cm
Base-Ø/H: 18/2,5 cm
Mains cable-L: 2 m

Dimensions: (155652)
Product-Ø/H: 46/166 cm
Shade-Ø/H: 46/32,5 cm
Base-Ø/H: 28/3 cm
Mains cable-L: 2 m

Accessory/Included parts:
Switch or foot switch in mains
cable (incl.)

Versions:
Shade black transparent outside
Shade white inside
Bishade TL-1 **155651**

Bishade SL-1 **155652**

Recommended bulb (155652):
23W, 2700K, 1350lm, EEK=A
508970



Recommended bulb:
SMD LED 10W
2800K-3000K, 700lm, EEK=A
551342



BISHADE PD-1



Socket/Bulb:
E27/EnergySaver (excl.)
3x 23W max.
up to max. length: 17 cm

Material:
Steel/textile/PS

Dimensions:
Canopy-Ø/H: 15/2,5 cm
Shade-Ø/H: 60/38,5 cm

Versions:
Canopy chrome
Shade black transparent outside
Shade white inside **155650**

Recommended bulb:
23W, 2700K, 1350lm, EEK=A
508970







CORDA

PENDANT LUMINAIRES

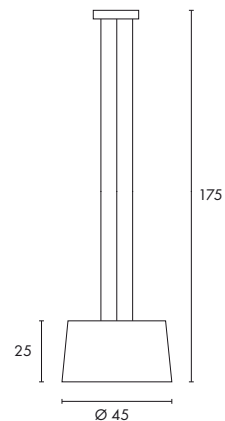

CORDA

230~

1,5m



Socket/Bulb:
E27/AGL (excl.)
3x 60W max.
or
E27/EnergySaver (excl.)
up to max. length: 11,6 cm

Material:
Steel/textile/acrylic

Dimensions:
Canopy-Ø/H: 15/2,5 cm

Versions:
Canopy nickel brushed
Acrylic glass satined
Shade black
Shade beige

Art. No.:
155400
155402

Recommended bulb:
11W, 2700K, 530lm, EEK=A
508950

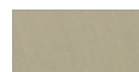

SOPRANA

RESIDENTIAL LUMINAIRES

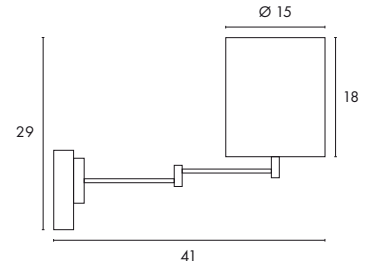

SOPRANA WL-1

230~



Socket/Bulb:
E27/AGL (excl.)
40W max.
or
E27/EnergySaver (excl.)
up to max. length: 15 cm

Material:
Steel/textile/acrylic

Dimensions:
Shade-Ø/H: 15/18 cm
Arm-L: 30 cm
Canopy-W/H/D: 8,4/12/3 cm

Versions:
chrome/shade black
chrome/shade white

Art. No.:
155620
155621

Recommended bulb:
15W, 2700K, 850lm, EEK=A
508740





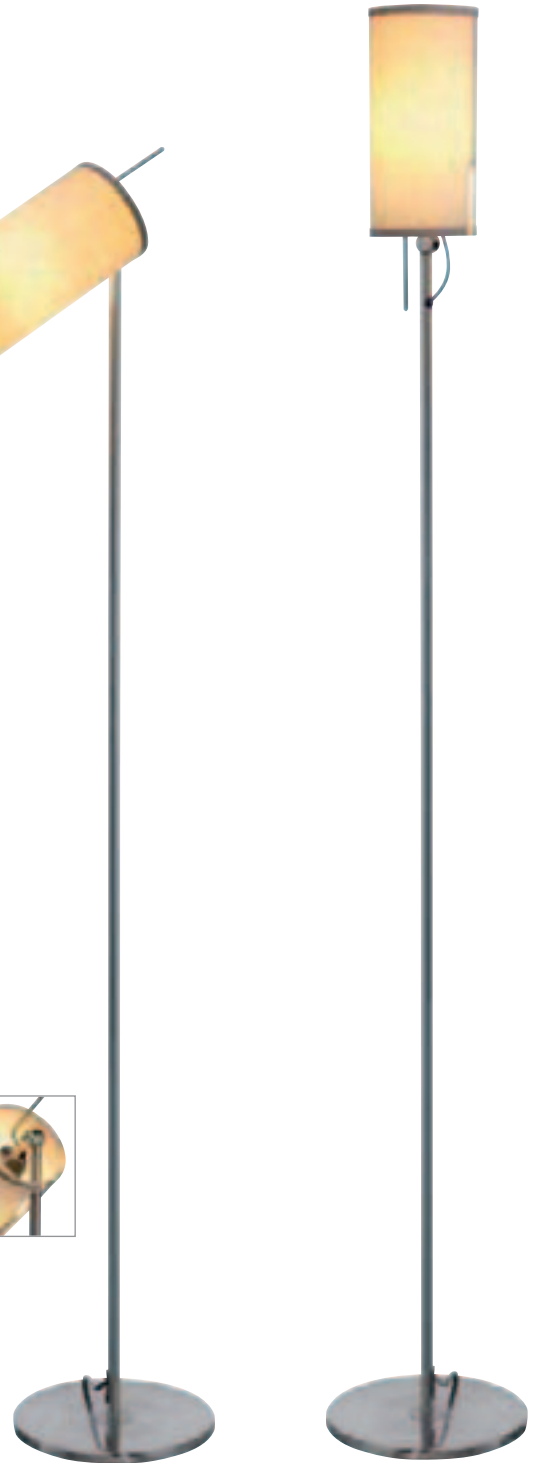
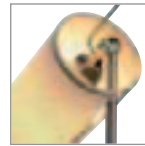
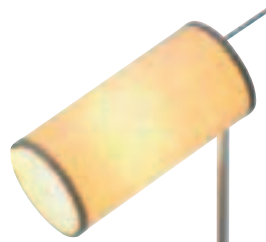

SOPRANA WL-2



Socket/Bulb:
E27/AGL (excl.)
40W max.
or
E27/EnergySaver (excl.)
up to max. Ø/L: 6,6/17,3 cm
20W max.

Material:
Steel/plastic/textile

Dimensions:
W/H/D: 16/30/12 cm
Canopy-W/H/D: 10/22/2,5 cm

Versions:
chrome
Shade beige

Art. No.:
155643

Recommended bulb:
15W, 2700K, 800lm, EEK=A
508960



SOPRANA SL-3



Socket/Bulb:
E27/AGL (excl.)
40W max.
oder
E27/EnergySaver (excl.)
up to max. Ø/L: 6,6/17,3 cm
20W max.

Material:
Steel/plastic/textile

Dimensions:
Product-H: 182 cm
Head-Ø/H: 13/27 cm
Base-Ø/H: 26/1,6 cm
Mains cable: 2 m

Versions:
chrome
Shade beige

Art. No.:
155633

Recommended bulb:
15W, 2700K, 850lm, EEK=A
508740



Accessory/Included parts:
Foot switch in mains cable (incl.)



SOPRANA SOLID

RESIDENTIAL LUMINAIRES

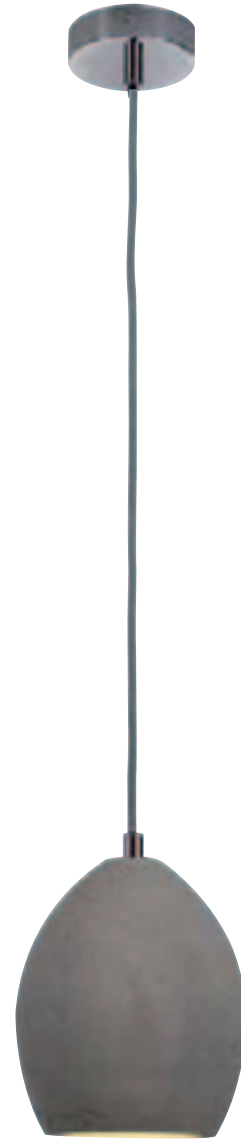

The structure of the Soprana Solid luminaire body is achieved by a special manufacturing process. Each lamp is an unique.

SOPRANA SOLID TL-1



230~



Socket/Bulb:
E27/AGL (excl.)
40W max.
or
E27/EnergySaver (excl.)
23W max.
up to max. length: 13 cm

Material:
Concrete/textile

Dimensions:
Ø/H: 28,5/35,5 cm
Shade-Ø/H: 28,5/18 cm
Base-Ø/H: 18/23,5 cm
Mains cable-L: 1,8 m

Accessory/Included parts:
Switch in mains cable (incl.)

Versions:
concrete grey
Shade grey beige

Art. No.:
155700

Recommended bulb:
15W, 2700K, 800lm, EEK=A
508960



SOPRANA SOLID PD-1



230~



Socket/Bulb:
E14/AGL (excl.)
25W max.
or
E14/EnergySaver (excl.)
11W max.
up to max. length: 13 cm

Material:
Concrete

Dimensions:
Head-Ø/H: 15/18,5 cm
Canopy-Ø/H: 10/2,5 cm

Versions:
concrete grey

Art. No.:
155710

Recommended bulb:
11W, 2700K, 530lm, EEK=A
508810







SOPRANA CL-1

230~

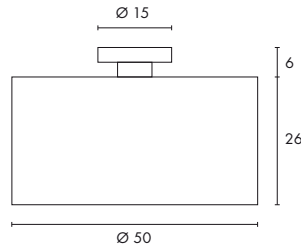

Socket/Bulb:
E27/AGL (excl.)
3x 60W max.
or
E27/EnergySaver (excl.)
up to max. length: 14,5 cm

Material:
Steel/textile/PS
Pane: acrylic

Dimensions:
Product-Ø/H: 50/32 cm

Versions:
Canopy chrome
Acrylic glass satined
Shade white
Shade beige

Art. No.:

155372
155373

Recommended bulb:
23W, 2700K, 1350lm, EEK=A
508970

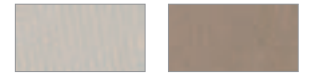

SOPRANA TL-2

230~

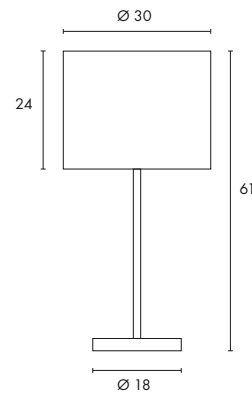

Socket/Bulb:
E27/AGL (excl.)
60W max.
or
E27/EnergySaver (excl.)
up to max. length: 14,5 cm

Material:
Shade: textile/PS
Rod/base: steel

Dimensions:
Mains cable-L: 2 m

Accessory/Included parts:
Switch in mains cable (incl.)

Versions:
metal brushed
Shade white
Shade beige

Art. No.:

155352
155353

Recommended bulb:
15W, 2700K, 800lm, EEK=A
508960



Recommended bulb:
SMD LED 10W
2800K-3000K, 700lm, EEK=A
551342

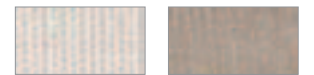

SOPRANA SL-2

230~

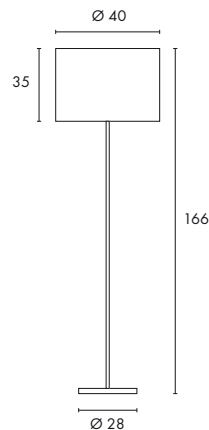

Socket/Bulb:
E27/AGL (excl.)
60W max.
or
E27/EnergySaver (excl.)
up to max. length: 17,5 cm

Material:
Shade: textile/PS
Rod/base: steel

Dimensions:
Mains cable-L: 2 m

Accessory/Included parts:
Foot switch in mains cable (incl.)

Versions:
metal brushed
Shade white
Shade beige

Art. No.:

155362
155363

Recommended bulb:
23W, 2700K, 1350lm, EEK=A
508970



Recommended bulb:
SMD LED 10W
2800K-3000K, 700lm, EEK=A
551342





SOPRANA PD-2

230~

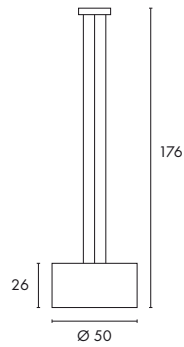
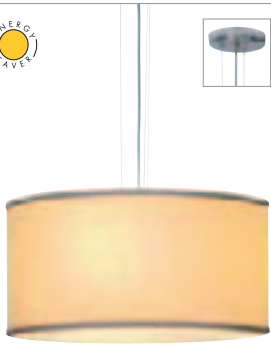

Socket/Bulb:
E27/AGL (excl.)
3x 60W max.
or
E27/EnergySaver (excl.)
up to max. length: 14,5cm

Material:
Shade: textile/PS
Canopy: steel

Dimensions:
Canopy-Ø/H: 15/2,5 cm

Versions: chrome
Shade creamy-white

Art. No.: 155432

Recommended bulb:
23W, 2700K, 1350lm, EEK=A
508970



SOPRANA TL-1

230~

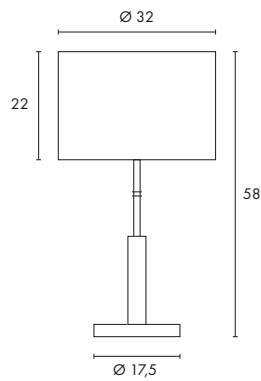

Socket/Bulb:
E27/AGL (excl.)
60W max.
or
E27/EnergySaver (excl.)
up to max. length: 14,5 cm

Material:
Shade: textile/PS
Rod: steel/textile leather

Dimensions:
Mains cable-L: 2 m

Accessory/Included parts:
Switch in mains cable (incl.)

Versions: chrome/black
Shade creamy-white

Art. No.: 155412

Recommended bulb:
15W, 2700K, 800lm, EEK=A
508960



Recommended bulb:
SMD LED 10W
2800K-3000K, 700lm, EEK=A
551342



SOPRANA SL-1

230~

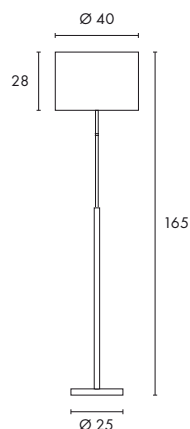

Socket/Bulb:
E27/AGL (excl.)
60W max.
or
E27/EnergySaver (excl.)
up to max. length: 17,5 cm

Material:
Shade: textile/PS
Rod: steel/textile leather

Dimensions:
Mains cable-L: 2 m

Accessory/Included parts:
Foot switch in mains cable (incl.)

Versions: chrome/black
Shade creamy-white

Art. No.: 155422

Recommended bulb:
23W, 2700K, 1350lm, EEK=A
508970



Recommended bulb:
SMD LED 10W
2800K-3000K, 700lm, EEK=A
551342









SOPRANA PD-1

230~

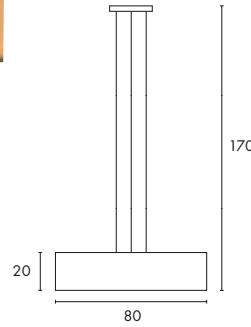
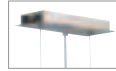

Socket/Bulb:
E27/AGL (excl.)
4x 60W max.
or
E27/EnergySaver (excl.)
up to max. length: 18 cm

Material:
Steel/textile/glass

Dimensions:
L/W/H: 80/30/20 cm
Canopy-L/W/H: 22/8/2,5 cm

Versions:
Canopy chrome/satined glass
Shade white 155292
Shade beige 155293

Art. No.:

Recommended bulb:
23W, 2700K, 1350lm, EEK=A
508970



SOPRANA PD-4

230~

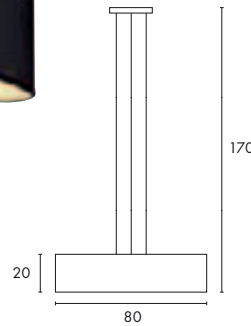

Socket/Bulb:
E27/AGL (excl.)
3 x 40W max.
or
E27/EnergySaver (excl.)
up to max. length: 16 cm

Material:
Steel/textile/glass

Dimensions:
L/W/H: 80/30/20 cm
Canopy-L/W/H: 30/8,5/3,5 cm

Versions:
Canopy chrome/satined glass
Shade black 155280
Shade beige 155283

Art. No.:

Recommended bulb:
15W, 2700K, 800lm, EEK=A
508960



SOPRANA PD-3

230~

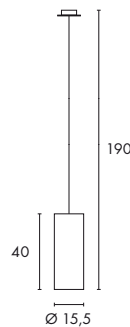

Socket/Bulb:
E27/AGL (excl.)
40W max.
or
E27/EnergySaver (excl.)
up to max. length: 14,5 cm

Material:
Steel/textile/PS

Dimensions:
Canopy-Ø/H: 12/3 cm

Versions:
Canopy chrome
Shade white 155382
Shade beige 155383

Art. No.:

Recommended bulb:
20W, 2700K, 1150lm, EEK=A
508830



Recommended bulb:
SMD LED 10W
2800K-3000K, 700lm, EEK=A
551342

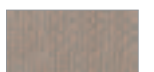



LASSON

RESIDENTIAL LUMINAIRES

The iridescent optic of the Lasson lampshades originates from the woven black and beige threads.



LASSON WL-1

230~    

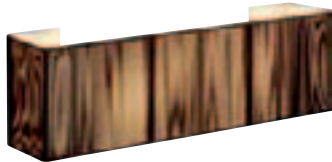

Socket/Bulb:
E27/AGL (excl.)
2x 40W max.
or
E27/EnergySaver (excl.)
up to max. Ø: 5 cm

Material:
Steel/textile/PS

Dimensions:
W/H/D: 60/18/12 cm
Canopy-W/H/D: 3.5/12/2 cm

Versions:
Shade black

Art. No.:
155330

Recommended bulb:
20W, 2700K, 1150lm, EEK=A
508830



Recommended bulb:
SMD LED 10W
2800K-3000K, 700lm, EEK=A
551342



LASSON CL-1

230~    

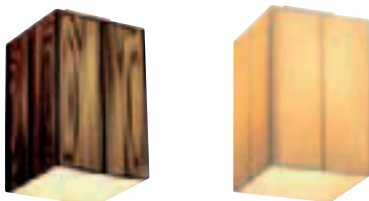

Socket/Bulb:
E27/AGL (excl.)
60W max.
or
E27/EnergySaver (excl.)
up to max. length: 26 cm

Material:
Steel/textile/PS

Dimensions:
L/W/H: 20/20/33 cm

Versions:
Shade black
Shade beige

Art. No.:
155320
155321

Recommended bulb:
20W, 2700K, 1150lm, EEK=A
508830





LASSON WL-2

230~



Socket/Bulb:
E27/AGL (excl.)
2x 40W max.
or
E27/EnergySaver (excl.)

Material:
Steel/textile/PS

Dimensions:
W/H/D: 20/60/20 cm
Canopy-W/H/D: 11/45,5/2,5 cm

Versions:
Shade black
Shade beige

Art. No.:
155310
155311

Recommended bulb:
20W, 2700K, 1150lm, EEK=A
508830



Recommended bulb:
SMD LED 10W
2800K-3000K, 700lm, EEK=A
551342



LASSON WL-3

230~



Socket/Bulb:
E27/AGL (excl.)
40W max.
or
E27/EnergySaver (excl.)
up to max. Ø/L: 5/20 cm
25W max.

Material:
Steel/textile/PS

Dimensions:
W/H/D: 22,5/29,5/11,5 cm
Canopy-W/H/D: 11/21,5/2,5 cm

Versions:
Shade black
Shade beige

Art. No.:
155340
155341

Recommended bulb:
15W, 2700K, 800lm, EEK=A
508960

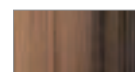





LASSON PD-1

230~



20

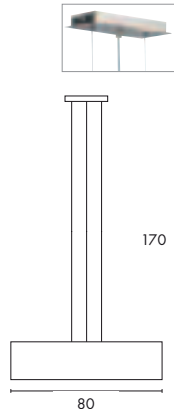

80

Socket/Bulb:
E27/AGL (excl.)
4x 60W max.
or
E27/EnergySaver (excl.)
up to max. Ø/L: 8/18 cm

Material:
Textile/steel/glass

Dimensions:
L/W/H: 80/30/20 cm
Canopy-L/W/H: 22/8/2,5 cm

Versions:
Canopy chrome/satin glass
Shade black 155290
Shade beige 155291

Art. No.:
155290
155291

Recommended bulb:
23W, 2700K, 1350lm, EEK=A
508970

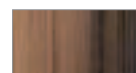



LASSON PD-3

230~

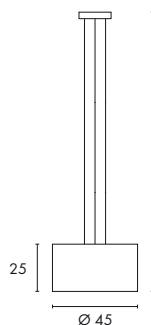

Socket/Bulb:
E27/AGL (excl.)
3x 60W max.
or
E27/EnergySaver (excl.)
up to max. length: 13 cm

Material:
Steel/textile/acrylic

Dimensions:
Canopy-Ø/H: 15/2,5 cm

Versions:
Canopy nickel brushed/
satinated acrylic
Shade black
Shade beige

Art. No.:
155300
155301

Recommended bulb:
23W, 2700K, 1350lm, EEK=A
508970





Lasson SL-1

Lasson TL-1

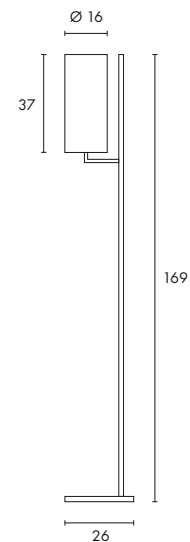
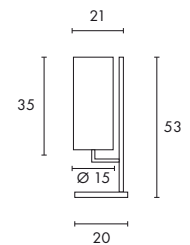

LASSON TL-1 / SL-1



230~



Socket/Bulb:
E27/AGL (excl.)
40W max.
or
E27/EnergySaver (excl.)
up to max. length: 14,5 cm

Versions:
chrome/black
Lasson TL-1

Art. No.:
155600

Material:
Steel/textile/PS

Lasson SL-1 155610

Dimensions:
Mains cable-l: 2 m

Accessory/Included parts:
Switch or foot switch in
mains cable (incl.)

Recommended bulb:
20W, 2700K, 1150lm, EEK=A
508830



LASSON PD-2



230~



Socket/Bulb:
E27/AGL (excl.)
40W max.
or
E27/EnergySaver (excl.)
up to max. length: 14,5 cm

Versions:
Canopy chrome
Shade black

Art. No.:
155380

Material:
Steel/textile/PS

Dimensions:
Canopy-Ø/H: 12/3 cm

Recommended bulb:
20W, 2700K, 1150lm, EEK=A
508830







CELLINERO | DECREDO

TABLE LUMINAIRES

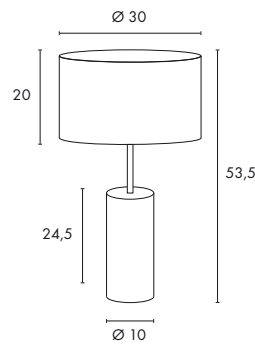
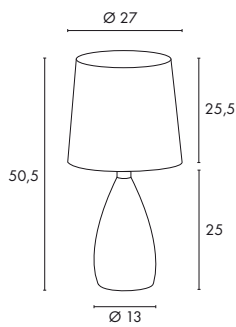

CELLINERO



230~



Socket/Bulb:
E27/AGL (excl.)
40W max.
or
E27/EnergySaver (excl.)
up to max. length: 19 cm
25W max.

Material:
Shade outside: imitation leather
Base: steel/imitation leather

Dimensions:
Ø/H: 27/50,5 cm
Mains cable-L: 2 m

Accessory/Included parts:
Switch in mains cable (incl.)

Versions:
dark brown

Art. No.:
155664

Recommended bulb:
15W, 2700K, 800lm, EEK=A
508960



Recommended bulb:
SMD LED 10W
2800K-3000K, 700lm, EEK=A
551342



DECREDO



230~



Socket/Bulb:
E27/AGL (excl.)
60W max.
or
E27/EnergySaver (excl.)
up to max. length: 14,5 cm

Material:
Shade: textile/PS
Base: steel/textile leather

Dimensions:
Mains cable-L: 1,85 m

Accessory/Included parts:
Switch in mains cable (incl.)

Versions:
metal brushed
Shade black

Art. No.:
155440

Recommended bulb:
15W, 2700K, 800lm, EEK=A
508820



Recommended bulb:
SMD LED 10W
2800K-3000K, 700lm, EEK=A
551342





ACCANTO

TABLE LUMINAIRES

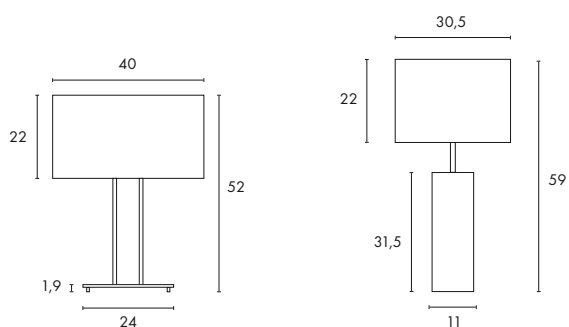

ACCANTO TWIN



230~



Socket/Bulb:

E27/AGL (excl.)
60W max.
or
E27/EnergySaver (excl.)
up to max. length: 14 cm

Material:

Shade: textile/PS
Base: steel

Dimensions:

L/W/H: 20/40/52 cm
Mains cable-L: 2 m

Accessory/Included parts:

Switch in mains cable (incl.)

Versions:

nickel brushed
Shade white
Shade brown

Art. No.:

155392
155394

Recommended bulb:

15W, 2700K, 800lm, EEK=A
508820



Recommended bulb:

SMD LED 10W
2800K-3000K, 700lm, EEK=A
551342



ACCANTO



230~



Socket/Bulb:

E27/AGL (excl.)
60W max.
or
E27/EnergySaver (excl.)
up to max. length: 17,5 cm

Material:

Shade: textile/PS
Base: textile leather

Dimensions:

L/W/H: 30,5/30,5/59 cm
Mains cable-L: 1,85 m

Accessory/Included parts:

Switch in mains cable (incl.)

Versions:

chrome/black
Shade beige

Art. No.:

155452

Recommended bulb:

15W, 2700K, 800lm, EEK=A
508820



Recommended bulb:

SMD LED 10W
2800K-3000K, 700lm, EEK=A
551342







ACCANTO LEDSPOT | COUPA

WALL LUMINAIRES

ACCANTO LEDSPOT



Socket/Bulb:
E27/EnergySaver (excl.)
24W max.
up to max. length: 18 cm
and
PowerLED, 1W (incl.)

Material:
Steel/textile/PS

Dimensions:
W/H/D: 26/27,5/13,5 cm

Accessory/Included parts:
LED driver (incl.)
Switch (incl.)



Versions:
LED 3000K
Shade black
Shade beige

Art. No.:
155670
155673

Recommended bulb:
11W, 2700K, 530lm, EEK=A
508950



Recommended bulb:
SMD LED 10W
2800K-3000K, 700lm, EEK=A
551342



COUPA FLEXLED

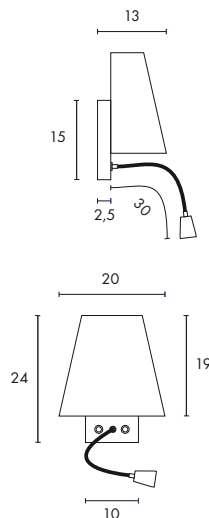
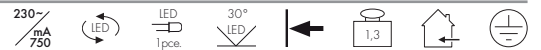

Socket/Bulb:
G9/G9 (excl.)
40W max.
or
G9/EnergySaver (excl.)
up to max. length: 9 cm
and
PowerLED, 3W (incl.)

Material:
Steel/glass

Accessory/Included parts:
LED converter (incl.)
Switch (incl.)

Versions:
chrome/white/satined glass
LED 3000K

Art. No.:
149452

Recommended bulb:
9W, 2700K, 405lm, EEK=A
508940





RIOTTE

RESIDENTIAL LUMINAIRES

RIOTTE WALL

230~

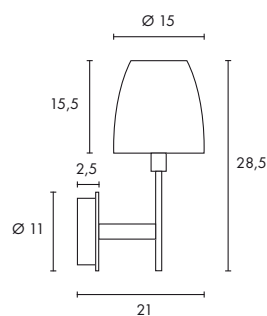
Socket/Bulb:

E14/AGL (excl.)
40W max.
or
E14/EnergySaver (excl.)
up to max. Ø/L: 5/11,5 cm

Material:

Steel/glass

Versions:

chrome/satiné glass

Art. No.:

146922

Recommended bulb:

7W, 2700K, 285lm, EEK=A
508800



RIOTTE SMALL

230~

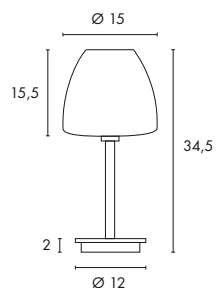
Socket/Bulb:

E14/AGL (excl.)
40W max.
or
E14/EnergySaver (excl.)
up to max. Ø/L: 5/11,5 cm

Material:

Steel/satiné glass

Dimensions:

Mains cable-L: 1,5 m

Accessory/Included parts:

Switch in mains cable (incl.)

Versions:

chrome/satiné glass

Art. No.:

146902

Recommended bulb:

7W, 2700K, 285lm, EEK=A
508800



RIOTTE

230~

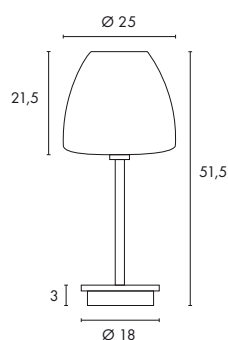
Socket/Bulb:

E27/AGL (excl.)
60W max.
or
E27/EnergySaver (excl.)
up to max. Ø/L: 6/15 cm

Material:

Steel/glass

Dimensions:

Mains cable-L: 1,5 m

Accessory/Included parts:

Switch in mains cable (incl.)

Versions:

chrome/satiné glass

Art. No.:

146912

Recommended bulb:

23W, 2700K, 1350lm, EEK=A
508970







ROVEN

PENDANT LUMINAIRE

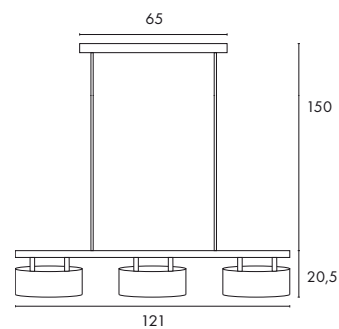

ROVEN

230~

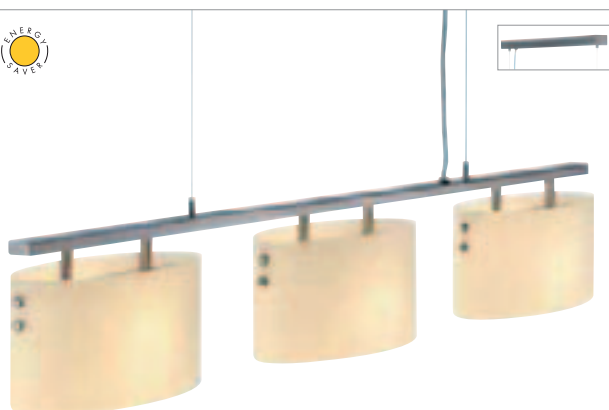

Socket/Bulb:
E14/AGL (excl.)
3x 40W max.
or
E14/EnergySaver (excl.)
up to max. Ø/L: 5/12 cm

Material:
Steel/glass

Dimensions:
L/W/H: 121/12,5/20,5 cm
Shade-L/W: 29,5/12,5 cm
Canopy-L/W/H: 65/5/4 cm

Accessory/Included parts:
Canopy (incl.)

Versions:
metal brushed/
Glass satined

Art. No.:
133600

Recommended bulb:
11W, 2700K, 530lm, EEC=A
508810



MALANG

RESIDENTIAL LUMINAIRES

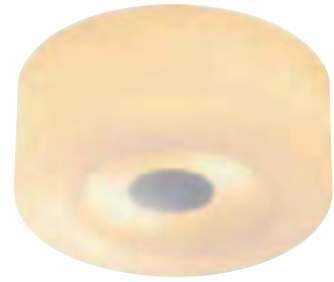

MALANG CL-1

230~



Socket/Bulb:
E27/AGL (excl.)
2x 60W max.
or
E27/EnergySaver (excl.)
up to max. Ø/L: 5,5/13,5 cm

Material:
Steel/glass

Dimensions:
Product-Ø/H: 32/13,5 cm

Versions:
chrome/satinated glass

Art. No.:
146942

Recommended bulb:
15W, 2700K, 800lm, EEK=A
508960

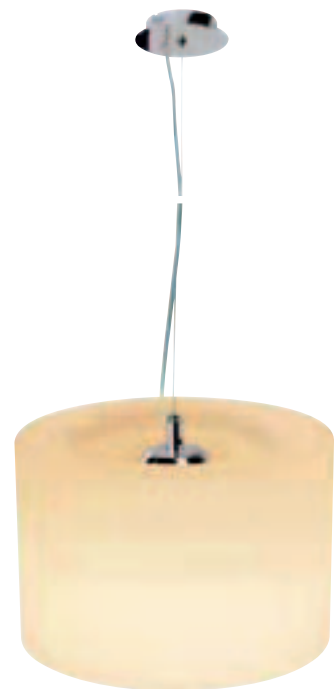

MALANG PD-1

230~



Socket/Bulb:
E27/AGL (excl.)
60W max.
or
E27/EnergySaver (excl.)
up to max. length: 15,8 cm

Material:
Aluminium/glass

Dimensions:
Shade-Ø/H: 32/22 cm
Canopy-Ø/H: 13/2,5 cm

Accessory/Included parts:
Canopy (incl.)

Versions:
chrome/satinated glass

Art. No.:
133592

Recommended bulb:
20W, 2700K, 1150lm, EEK=A
508830





FORCHINI

PENDANT LUMINAIRES

Handmade - Each lamp is an unique.



Forchini PD-1

Forchini PD-2

FORCHINI PD-1



230~



Socket/Bulb:
E27/AGL (excl.)
40W max.
or
E27/EnergySaver (excl.)
up to max. length: 20 cm

Material:
Steel/glass fiber reinforced plastic
Textile cable in housing colour

Dimensions:
Shade-Ø/H: 50/25,5 cm
Canopy-Ø/H: 11/2 cm

Accessory/Included parts:
Canopy chrome (incl.)

Versions:
black/chrome
inside silver
inside gold

white/chrome
inside silver
inside gold

Art. No.:
155520
155530

155521
155531

Recommended bulb:
20W, 2700K, 1150lm, EEK=A
508830



FORCHINI PD-2



230~



Socket/Bulb:
E27/AGL (excl.)
40W max.
or
E27/EnergySaver (excl.)
up to max. length: 14 cm

Material:
Steel/glass fiber reinforced plastic
Textile cable in housing colour

Dimensions:
Shade-Ø/H: 38/19 cm
Canopy-Ø/H: 11/2 cm

Accessory/Included parts:
Canopy chrome (incl.)

Versions:
black/chrome
inside silver
inside gold

white/chrome
inside silver
inside gold

Art. No.:
155500
155510

155501
155511

Recommended bulb:
15W, 2700K, 800lm, EEK=A
508820







CONE SHADE | PD 115 E27

PENDANT LUMINAIRES



CONE SHADE Satin/Tinto Design by CDC



230~



Socket/Bulb:
E27/AGL (excl.)
60W max.
or
E27/EnergySaver (excl.)
up to max. length: 17,5 cm

Versions:
black/chrome
Glass satined/chrome

Art. No.:
165500
165501

Material:
Steel/glass (165501)
Steel/aluminium (165500)
Black textile cable

Recommended bulb:
20W, 2700K, 1150lm, EEK=A
508830



Dimensions:
Ø/H: 26,5/35 cm
Canopy-Ø/H: 9/2 cm

Recommended bulb:
SMD LED 10W
2800K-3000K, 700lm, EEK=A
551342



Accessory/Included parts:
Canopy chrome (incl.)

PD 115 E27



230~



Socket/Bulb:
E27/AGL (excl.)
60W max.
or
E27/EnergySaver (excl.)
25W max.

Versions:
black
white

Art. No.:
155470
155471

Material:
Steel/aluminium
Red textile cable

Recommended bulb:
20W, 2700K, 1150lm, EEK=A
508830



Dimensions:
Shade-Ø/H: 40,5/38 cm
Canopy-Ø/H: 12/3 cm

Recommended bulb:
SMD LED 10W
2800K-3000K, 700lm, EEK=A
551342



Accessory/Included parts:
Canopy chrome (incl.)



PLASTER LUMINAIRES

Wall luminaires
high-voltage

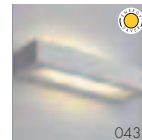
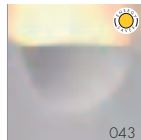
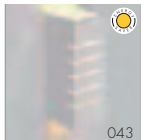

Ceiling luminaires
high-voltage

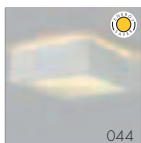

Recessed luminaires
low-voltage

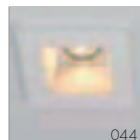
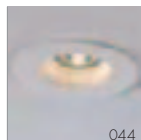
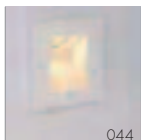

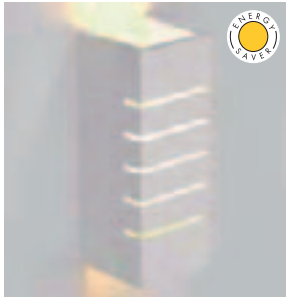

GL 100 SLOT
Plaster wall luminaire

Material: Plaster/steel

Recommended bulb:
11W, 2700K, 530lm, EEK=A
508810

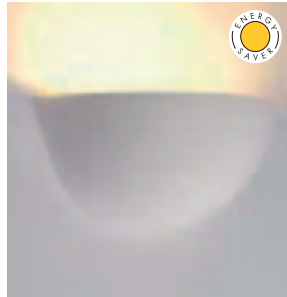

GL 101 E14
Plaster wall luminaire

Material: Plaster/steel

Recommended bulb:
11W, 2700K, 530lm, EEK=A
508810



GL 102 CURVE
Plaster wall luminaire

Material: Plaster/steel

Recommended bulb:
100W EnergySaver \neq 150W
2700K, 1900lm, EEK=C
519215



GL 103 T5
Plaster wall luminaire

Material: Plaster/steel/glass
Accessory/Included parts: Electronic ballast (incl.)

Recommended bulb:
8W, 3000K, 400lm
591293

(PU see page 661)



PLASTER WALL LUMINAIRES high-voltage

230~



Article No.	Description	Colour	Voltage in AC	Socket/ Bulb (excl.)	Wattage Bulb	Width in cm	Height in cm	Depth in cm	Weight in kg	Price
148010	GL 100 Slot	white	230V	E14/AGL or E14/EnergySaver up to max. L:12 cm	40W max.	9,0	24,0	9,0	0,81	
148013	GL 101 E14	white	230V	E14/AGL or E14/EnergySaver up to max. L:12 cm	40W max.	28,0	13,0	14,0	1,25	
148012	GL 102 Curve	white	230V	R7s/R7s, 78 mm	100W max.	36,0	6,5	17,0	1,58	
148011	GL 103 T5	white	230V	G5/T5 EnergySaver	8W	36,0	6,0	10,0	1,30	

Accessory/Included parts: Fine abrasive paper for surface cleaning (incl.)

The lamps can be painted over with wall paint after priming.



GL 104 | 148002 |

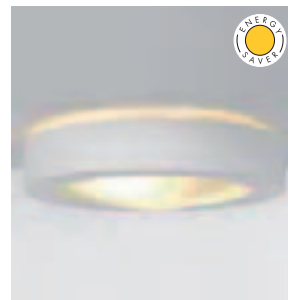

GL 105 | 148001 |

GL 104/105 E27 plaster ceiling luminaires

230~



Material:
Plaster/steel/glass

Recommended bulb:
15W, 2700K, 800lm, E27/A
508960



Article No.	Description	Colour	Voltage in AC	Socket/Bulb (excl.)	Wattage Bulb	Ø in cm	Length in cm	Width in cm	Height in cm	Weight in kg	Price
148002	GL 104 E27	white	230V	E27/AGL or E27/EnergySaver	2x 25W max. or 2x 15W max. up to max. Ø/L:5/14 cm	-	25,0	25,0	9,5	2,6	
148001	GL 105 E27	white	230V	E27/AGL or E27/EnergySaver	2x 25W max. or 2x 15W max. up to max. Ø/L:5/14 cm	31,0	-	-	8,0	2,3	

Accessory/Included parts: fine abrasive paper for surface cleaning (incl)

The lamps can be painted over with wall paint after priming.

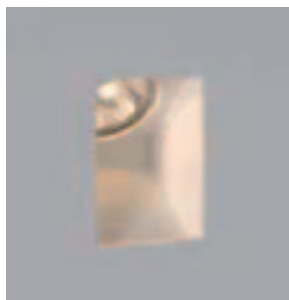

GL 108 flush | 148022 |



GL 108 overlying | 148022 |



GL 109 overlying | 148020 |



GL 110 overlying | 148021 |

GL Plaster recessed luminaires

12~



Material:
Plaster/steel

Note:
Do not cover the rear side of the lamp with insulating material!
The lamps can be painted over with wall paint after priming.

Recommended bulb:
35W, 2700K, 810cd, 40°
536338



Recommended transformer:
FN Minitrafo 1, 10-60VA, 12~
461060

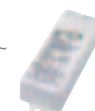

Accessory/Included parts:
Transformer (excl.)
Fine abrasive paper for surface cleaning (incl.)

Article No.	Description	Colour	Voltage in AC	Socket/Bulb (excl.)	Wattage Bulb	Ø in cm	Length in cm	Width in cm	Depth in cm	Cut-out in cm	Installation depth in cm	Application area	Weight in kg	Price
148022	GL 108 Indi	white	12V	G5,3/MR16	35W max.	-	14,0	14,0	13,0	12,0/12,0	12,0	Wall/Ceiling	0,68	
Only suitable for cavity ceilings and walls with a material thickness of max. 10-20 mm by overlying and 10-15 mm by flush installation. The specification on the cut-out apply to overlying installation.														
148020	GL 109 Horn	white	12V	G5,3/MR16	35W max.	13,0	-	-	13,5	Ø 11,0	13,0	Ceiling	0,43	
148021	GL 110 MR16	white	12V	G5,3/MR16	35W max.	-	13,0	13,0	14,0	11,5/11,5	13,0	Ceiling	0,50	

Only suitable for cavity ceilings with a material thickness of max. 15 mm by overlying and 10-15 mm by flush installation.

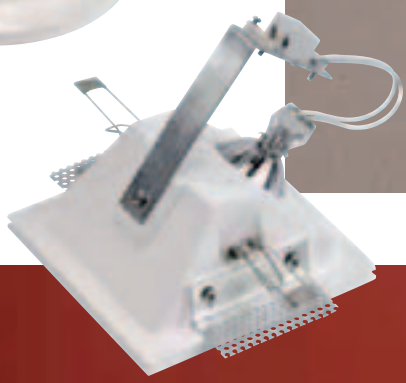
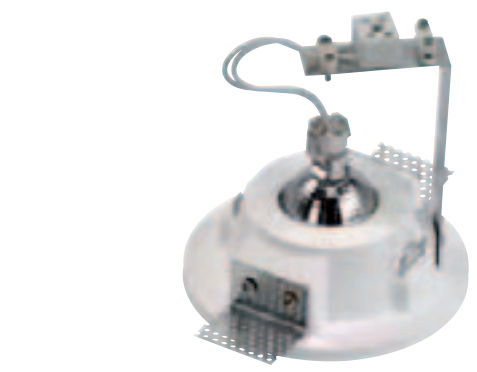



TABLE & FLOOR LUMINAIRES

Floor spotlights

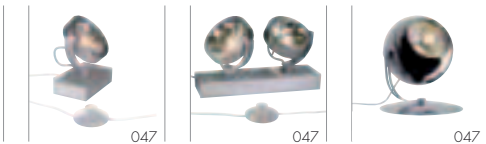

Table luminaires



Floor luminaires





KALU FLOOR 1 Design by CDC



Series: Page 152, 402



Socket/Bulb:
G53/QRB111 (excl.)
50W max.

Material:
Aluminium

Dimensions:
L/W/H: 15/9/19,2 cm
Mains cable-L: 2 m

Accessory/Included parts:
Electronic transformer (incl.)
Foot switch in mains cable (incl.)

Versions:
alu brushed

Art. No.:
147286

Recommended bulb:
50W EnergySaver \approx 75W
545752 24°, 3000K, 5800cd



Recommended bulb:
PowerLED 10W, warm white
550132 40°, 430lm



KALU FLOOR 2 Design by CDC



Series: Page 152, 402



Socket/Bulb:
G53/QRB111 (excl.)
2x 50W max.

Material:
Aluminium

Dimensions:
L/W/H: 30/9/19,2 cm
Mains cable-L: 2 m

Accessory/Included parts:
Electronic transformer (incl.)
Foot switch in mains cable (incl.)

Versions:
alu brushed

Art. No.:
147296

Recommended bulb:
50W EnergySaver \approx 75W
545752 24°, 3000K, 5800cd



Recommended bulb:
PowerLED 10W, warm white
550132 40°, 430lm



LIGHT EYE FLOOR Design by CDC



Series: Page 084, 165, 252, 253, 276



Socket/Bulb:
GU10/ES111 (excl.)
75W max.

Material:
Steel

Dimensions:
Product-H: 19 cm
Head- \varnothing : 14,5 cm
Base- \varnothing : 18 cm
Mains cable-L: 2 m

Accessory/Included parts:
Foot switch in mains cable (incl.)

Versions:
chrome

Art. No.:
132862

Recommended bulb:
75W, 24°, 2700K, 2000cd
575672





PICOSI DESK



PICOSI DESK



230V
700mA



LED
1 pce.

60°

45°

2



Bulb:

Power LED
6W

Versions:

3000K, 330lm, Ra>80
chrome

Art. No.:

146072

Material:

Aluminium/steel

white
silver grey

146071
146074

Dimensions:

Head-L/W/H: 20/6,5/1,2 cm
Rod-L: 52 cm
Mains cable-L: 2 m

Accessory/Included parts:

Switch in lamp head (incl.)
Power supply (incl.)

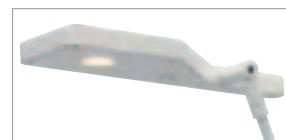

CYGNIS

Series: Page 082



With the table lamp Cygnis our product designers followed the conceptual formulation to create an high-class table lamp with the shape lines reduced to the essentials for a simple, elegant living style. Together with modern LED technology Cygnis captivates with its purist elegant design and high functionality. The ultra flat 6W LED surface makes the clear, geometrical shaped lines and provides a bright light output. The switch of the 41 cm high, entirely aluminium produces designer lamp is included in the connection lead. With the integrated LED driver in the mains plug the lamp is ready for use with 230V.



CYGNIS Table lamp Design by CDC



Bulb:
Planar LED (incl.)
6W

Versions:
alu brushed
LED 4000K, 270lm

Art. No.:
146046

Material:
Aluminium

Dimensions:
Product L/W/H: 40,5/14/41 cm
Mains cable L: 2 m

Accessory/Included parts:
Plug-in power supply (incl.)
Switch in mains cable (incl.)

Note:
Power supply: protection class II
prim.: 230V/50Hz
sec.: 15V/400mA

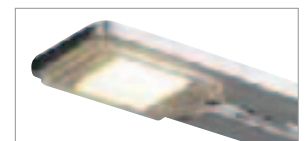



DEWI DESK

230~
12~

Socket/Bulb:
G6,35/pin-socket (incl.)
50W max.

Material:
Aluminium/ceramic

Dimensions:
Jib arm: 42/39 cm
Base-Ø: 20 cm
Shade-Ø: 9 cm
Mains cable-L: 1,9 m

Accessory/Included parts:
Transformer (incl.)
2-step switch (incl.)
Mains plug (incl.)

Versions:
silver grey
Ceramic white ▼

Art. No.:
146209

Recommended bulb:
50W, 2700K, 900lm
512250



DEWI FLOOR

230~
12~

Socket/Bulb:
G6,35/pin-socket (incl.)
50W max.

Material:
Aluminium/ceramic

Dimensions:
Jib arm: 42/39 cm
Base-Ø: 23 cm
Shade-Ø: 9 cm
Rod-L: 85 cm
Mains cable-L: 1,9 m

Accessory/Included parts:
Transformer (incl.)
2-step switch (incl.)
Mains plug (incl.)

Versions:
silver grey
Ceramic white ▼

Art. No.:
146509

Recommended bulb:
50W, 2700K, 900lm
512250



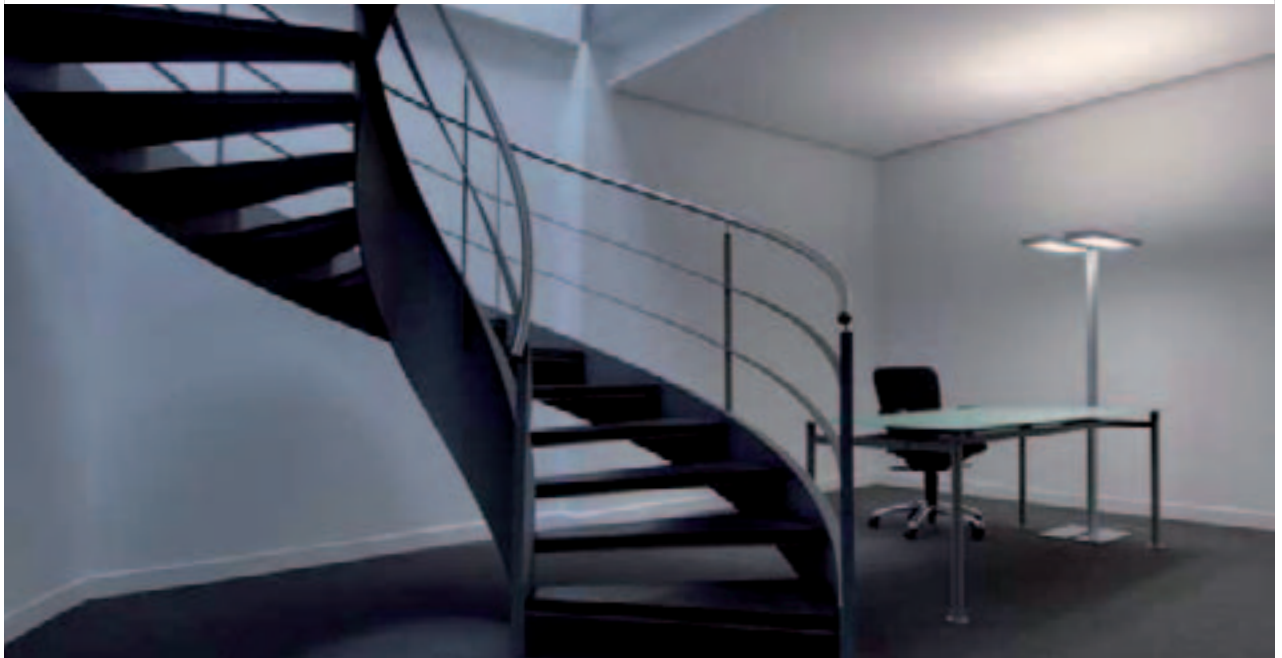

WORK LIGHT FLOOR Design by CDC

230~



Series: Page 063



Socket/Bulb:
2G11/TC-L EnergySaver (excl.)
4x 55W

Material:
Aluminium/plastic

Dimensions:
W/H/D: 42/185/60 cm
Base-L/B: 40/34,2 cm
Mains cable-L: 2 m

Accessory/Included parts:
Electronic ballast (incl.)
2 switches (incl.)
Mains plug (incl.)
Grid (excl.)

Note:
Two switches to operate the lamp with half or full luminous power.

Versions:
silver grey

Art. No.:
157152

Recommended bulb:
55W, 4000K, 4800lm, EEK=A
508451

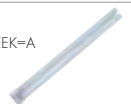

Recommended accessory:
Darklight Grid, ultra clean aluminium, high-gloss finished
L/W/H: 54,3/14/5 cm
157154

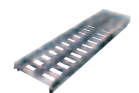







According to DIN 5035-7 the Darklight grid is suitable for display work stations. It provides a glare-free light and optimal illuminated work place. Two grids are needed for one lamp.

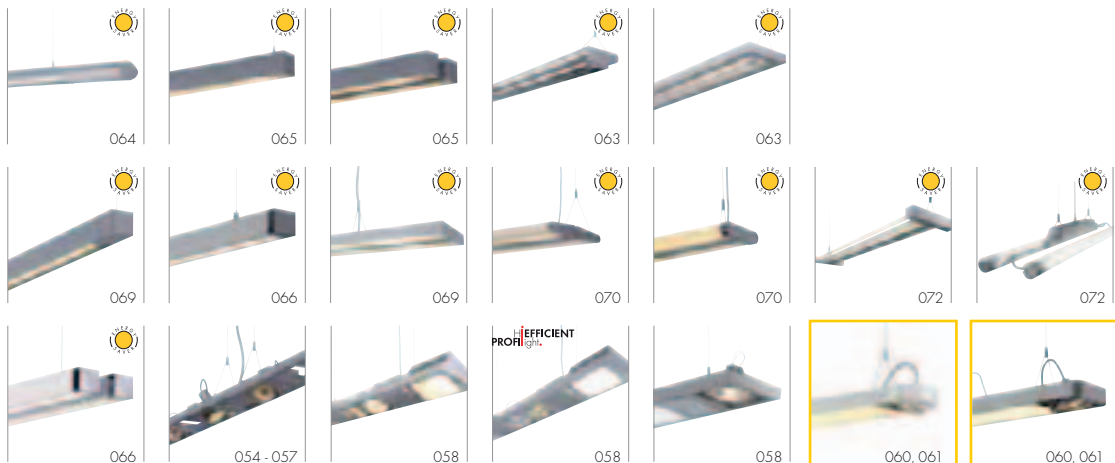

PENDANT LUMINAIRES

Linear fluorescent
and
grid luminaires for
display work
station



<p>Series Aixlight® MR16 GU10 QRB111 ES111</p>	 076	 076	 076	 076			
	 079	 079	 079	 078	 078		
<p>Series Aixlight® R QRB111 HQ-T Series Aixlight® R2 QRB111 HQ-T</p>	 080	 080	 080	 081	 081	 081	 081
<p>Series Grill</p>	 074	 074	 074				
<p>Single luminaires and light objects</p>	 086	 087	 096	 083			
	 091	 092	 092	 092	 093	 093	
	 091	 095	 091	 095	 095	 084	 084
	 089	 100	 100	 104			
	 084	 084	 089	 089	 087	 107	
	 102	 102	 099	 103	 099	 100	
	 108	 108	 108	 108			
<p>Professional lamps for the commercial use</p>	 109	 109	 109	 107			
<p>LED luminaires</p>	 082	 073	 073	 108	 104		



AIXLIGHT[®] Pendant System Design by CDC

1. Select the base frame for an individual mounting of lighting modules. Alternatively or additionally the T5-element is available



2. Direct connection of base frames and T5-elements with the frame connectors (1 set per connection). Alternatively, it can be mounted via the connection box, which serves as feed-in box as well. One screw-set is needed for every scheduled frame.



3. Select the combination of lighting modules to assemble the base frames.



4. Pendant luminaires or spots can be integrated into the Aixlight[®] Pendant System with the spotbox. The spotbox will be inserted into the frame like a lighting module.

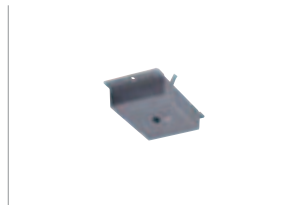

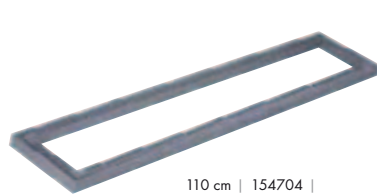

110 cm | 154704 |

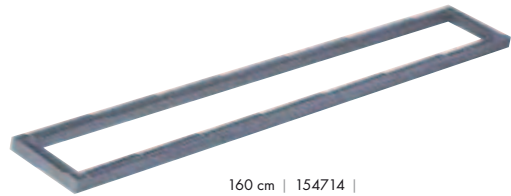

160 cm | 154714 |

BASE FRAME for Aixlight® Pendant System



Material:
Aluminium

Note:
Base frame for individual equipping with lamp modules.

Accessory/Included parts:
Suspension (incl.)

Article No.	Description	Colour	Length in cm	Width in cm	Height in cm	Weight in kg	Price
154704	Aixlight® Pendant System Base frame 1	silver grey	110,0	22,5	4,5	2,50	
154714	Aixlight® Pendant System Base frame 2	silver grey	160,0	22,5	4,5	3,54	

Direct connection to the connection/ feed-in box is possible (ill. 1).



In combination with the Tron canopy, it can be used as an independent pendant luminaire (ill. 2).

ill. 2

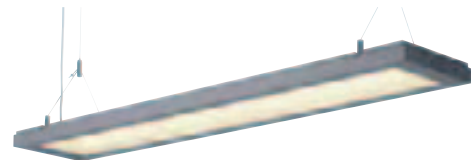

T5 ELEMENT for Aixlight® Pendant System



Material:
Aluminium

Accessory/Included parts:
Suspension (incl.)
Electronic ballast (incl.)
Canopy (excl.)

Recommended accessory:
Canopy Tron, silver grey
L/W/H: 10/5,5/3 cm
Strain relief (incl.)
925190

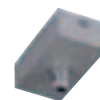

Recommended bulb:
54W, 3000K, 4450lm
548054

(PU see page 661)

Article No.	Description	Colour	Voltage in AC	Socket/ Bulb (excl.)	Wattage Bulb	Energy efficiency category ballast	Length in cm	Width in cm	Height in cm	Weight in kg	Price
154814	T5 Element	silver grey	230V	G5/T5 EnergySaver	2x 54W	EEL=A2	130,0	22,6	5,0	6,7	



1 QR/B MODULE
for Aixlight® Pendant System

100W max. 154774

Material: Aluminium
Dimensions: Supply line-L: 1,8 m
Included parts: Electronic transformer (incl.)
Accessory: see below

Recommended bulb:
50W EnergySaver Δ 75W
545752 24°, 3000K, 5800cd



2 QR/B MODULE
for Aixlight® Pendant System

2x 100W max. 154784

Material: Aluminium
Dimensions: Supply line-L: 1,8 m
Included parts: Electronic transformer (incl.)
Accessory: see below

Recommended bulb:
50W EnergySaver Δ 75W
545752 24°, 3000K, 5800cd



35W/70W HQI MODULE
for Aixlight® Pendant System

35W 38° 154824
70W 38° 154794

Material: Aluminium
Dimensions: Supply line-L: 1,8 m
Included parts: Electronic ballast (incl.)
Accessory: see below

Recommended bulb:
35W, 3300lm
507120 3000K, Ra81
507121 4200K, Ra90



Recommended bulb:
70W, 6600lm
507130 3000K, Ra84
507131 4200K, Ra92



PL MODULE
for Aixlight® Pendant System

2x 36W 154804

Material: Aluminium
Dimensions: Supply line-L: 1,8 m
Included parts: Electronic ballast (incl.)
Accessory: see below

Recommended bulb:
36W, 2900lm
590144 2700K, EEK=A



LAMP-MODULE for Aixlight® Pendant System



Article No.	Description	Colour	Voltage in AC	Socket/ Bulb (excl.)	Wattage Bulb	Energy efficiency category ballast	Length in cm	Width in cm	Height in cm	Rotation/ swivel range	Weight in kg	Price
154774	1er QR/B Module	silver grey	230V/12V	G53/QRB111	100W max.	-	32,0	19,0	8,0	cardanic/60°	1,50	
154784	2er QR/B Module	silver grey	230V/12V	G53/QRB111	2x 100W max.	-	47,5	19,0	8,0	cardanic/60°	1,85	
154824	35W HQI Module	silver grey	230V	G12/CDM-T	35W	EEI=A2	32,0	19,0	16,0	cardanic/60°	1,97	
154794	70W HQI Module	silver grey	230V	G12/CDM-T	70W	EEI=A2	32,0	19,0	16,0	cardanic/60°	1,97	
154804	PL Module	silver grey	230V	2G11/TC-L EnergySaver	2x 36W	EEI=A2	50,0	18,0	7,5	-	2,60	

For application in the base frame of the Aixlight® Pendant System. For operating, at least one base frame and the canopy is needed.

BASIC COMPONENTS Aixlight® Pendant System

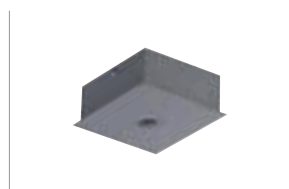

230~
Canopy with feed-in cable
Steel, silver grey
L/W/H: 11/10/4 cm
Supply line-L: 2,5 m
max. current: 16A.
Art. No.: 154734

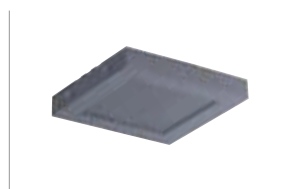

230~
Connection/feed-in box
Aluminium, silver grey
L/W/H: 22,5/22,5/3,5 cm
Art. No.: 154724

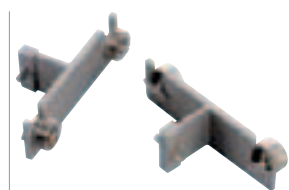

Frame connector
Aluminium, silver grey, 2 pce.
W/H/D: 7/2,5/2 cm
2 knurled-head screws (incl.)
Art. No.: 154754

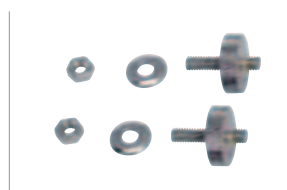

Connecting screw-set
Steel, chrome, 2 pce.
Total-Ø/L: 1,5/2 cm
One screw set is needed for every scheduled frame.
Art. No.: 154744

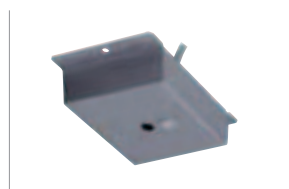

Spolbox
Aluminium, silver grey,
L/W/H: 18,5/10/3,5 cm
Art. No.: 154764





AIXLIGHT® OFFICE Design by CDC



Series: Page 151

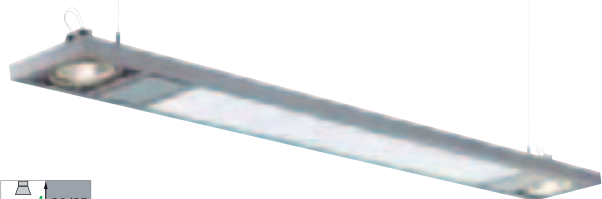

Socket/Bulb:
G13/T8 EnergySaver (excl.)
2x 36W
and
GU10/ES111 (excl.)
2x 75W max.

Material:
Aluminium
Diffusor PMMA

Dimensions:
L/W/H: 183/19/9 cm
Canopy-L/W/H: 7,4/4/2,5 cm

Accessory/Included parts:
Low-loss ballast (incl.)
Canopy (incl.)

Versions:
silver grey

Art. No.:
154332

Recommended bulb:
75W, 24°, 2700K, 2000cd
575672



Recommended bulb:
PowerLED 10W, 40°, 460lm
550352 warm white



AIXLIGHT® SHOP 1 Design by CDC



Socket/Bulb:
R7s/R7s, 118 mm (excl.)
2x 200W max.
and
GU10/ES111 (excl.)
2x 75W max.

Material:
Aluminium

Dimensions:
L/W/H: 118/19/9,5 cm
Canopy-L/W/H: 8/4,8/2,8 cm

Accessory/Included parts:
Canopy (incl.)

Versions:
silver grey

Art. No.:
154382

Recommended bulb:
100W EnergySaver ≠ 150W
2700K, 1900lm, EEK=C
519221



Recommended bulb:
75W, 24°, 2700K, 2000cd
575672



Recommended bulb:
PowerLED 10W, 40°, 460lm
550352 warm white



AIXLIGHT® SHOP 2 Design by CDC

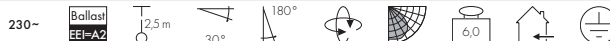

HiEFFICIENT
PROfilight.

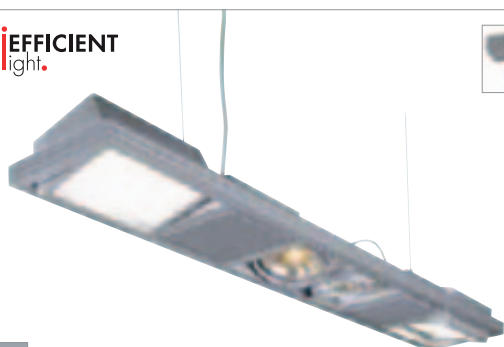

Socket/Bulb:
Rx7s/HQI-TS (excl.)
2x 70W
and
G53/QRB111 (excl.)
2x 75W max.

Material:
Aluminium

Dimensions:
L/W/H: 118/19/9,5 cm
Canopy-L/W/H: 8/4,8/2,8 cm

Accessory/Included parts:
Electronic ballast (incl.)
Electronic transformer (incl.)
Canopy (incl.)

Versions:
silver grey ▼

Art. No.:
154392

Recommended bulb:
70W, 4200K, 6500lm
509071



Recommended bulb:
50W EnergySaver ≠ 75W
545752 24°, 3000K, 5800cd







AIXLIGHT® R OFFICE T5, 39W Design by CDC



Socket/Bulb:
G5/T5 EnergySaver (excl.)
2x 39W
and
GU10/ES111 (excl.)
2x 75W max.

Versions:
black
white
silver grey

Art. No.:
159090
159091
159094

Material:
Aluminium/plastic

Recommended bulb:
39W, 3000K, 3220lm
548039

(PU see page 661)

Dimensions:
L/W/H: 122,5/18/5 cm
Canopy-L/W/H: 8,5/8,5/2,7 cm

Accessory/Included parts:
Electronic ballast (incl.)
Canopy (incl.)

Recommended bulb:
PowerLED 10W, 25°, 460lm
550342



Note:
The ES111 and T5 bulbs can be
switched separately.

AIXLIGHT® R2 OFFICE T5, 39W Design by CDC



Socket/Bulb:
G5/T5 EnergySaver (excl.)
2x 39W
and
GU10/ES111 (excl.)
2x 75W max.

Versions:
black
white
silver grey

Art. No.:
159100
159101
159104

Material:
Aluminium/plastic

Recommended bulb:
39W, 3000K, 3220lm
548039

(PU see page 661)

Dimensions:
L/W/H: 122,5/18/5 cm
Canopy-L/W/H: 8,5/8,5/2,7 cm

Accessory/Included parts:
Electronic ballast (incl.)
Canopy (incl.)

Recommended bulb:
PowerLED 10W, 25°, 460lm
550342



Note:
The ES111 and T5 bulbs can be
switched separately.



Aixlight® R Office T5 54W

Aixlight® R2 Office T5 54W

AIXLIGHT® R OFFICE T5, 54W Design by CDC



Socket/Bulb:
G5/T5 EnergySaver (excl.)
2x 54W
and
GU10/ES111 (excl.)
2x 75W max.

Versions:
black
white
silver grey

Art. No.:
159110
159111
159114

Material:
Aluminium/plastic

Dimensions:
L/W/H: 153/18/5 cm
Canopy-L/W/H: 8,5/8,5/2,7 cm

Accessory/Included parts:
Electronic ballast (incl.)
Canopy (incl.)

Note:
The ES111 and T5 bulbs can be
switched separately.

Recommended bulb:
54W, 3000K, 4450lm
548054

[PU see page 661]

Recommended bulb:
PowerLED 10W, 25°, 460lm
550342



AIXLIGHT® R2 OFFICE T5, 54W Design by CDC



Socket/Bulb:
G5/T5 EnergySaver (excl.)
2x 54W
and
GU10/ES111 (excl.)
2x 75W max.

Versions:
black
white
silver grey

Art. No.:
159120
159121
159124

Material:
Aluminium/plastic

Dimensions:
L/W/H: 153/18/5 cm
Canopy-L/W/H: 8,5/8,5/2,7 cm

Accessory/Included parts:
Electronic ballast (incl.)
Canopy (incl.)

Note:
The ES111 and T5 bulbs can be
switched separately.

Recommended bulb:
54W, 3000K, 4450lm
548054

[PU see page 661]

Recommended bulb:
PowerLED 10W, 25°, 460lm
550342







The pendant luminaires Long Grill and Work Light are equipped with a Dark-Light grid, suitable for display work stations according to DIN 5035-7. This allows an optimal illuminated work station and glare free light.

WORK LIGHT PENDANT Design by CDC

230~



Series: Page 051

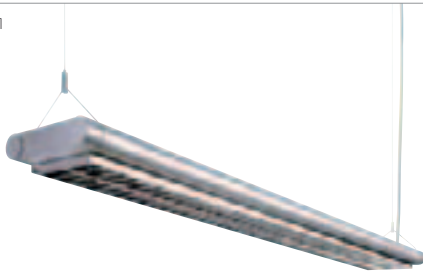

Socket/Bulb:
G5/T5 EnergySaver (excl.)
2x 54W

Material:
Aluminium

Dimensions:
L/W/H: 122,5/18,5/6 cm
Canopy-L/W/H: 7,5/7,5/2,5 cm

Accessory/Included parts:
Electronic ballast (incl.)
Canopy (incl.)
Grid (incl.)

Versions:
silver grey

Art. No.:
157284

Recommended bulb:
54W, 3000K, 4450lm
548054

(PU see page 661)

LONG GRILL

230~



Series: Page 222

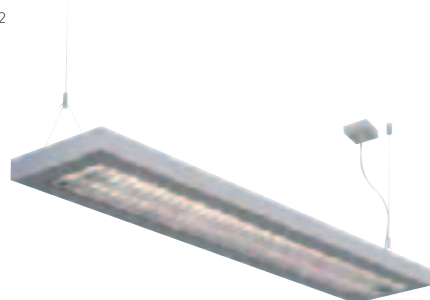

Socket/Bulb:
G5/T5 EnergySaver (excl.)
2x 28W/2x 54W

Material:
Aluminium

Dimensions:
L/W/H: 126/23/5,5 cm
Canopy-L/W/H: 7,5/7,5/2,5 cm

Accessory/Included parts:
Electronic ballast (incl.)
Canopy (incl.)

Versions:
silver grey
2x 28W
2x 54W

Art. No.:
157514
157524

Recommended bulb:
3000K
548028, 28W, 2640lm
548054, 54W, 4450lm

(PU see page 661)



HANG UP

230~



Socket/Bulb:
G13/T8 EnergySaver (excl.)
2x 36W

Material:
Aluminium

Dimensions:
L/W/H: 161/13/7 cm

Accessory/Included parts:
Low-loss ballast (incl.)
Canopy (excl.)
Supply line (excl.)

Versions:
alu anodized

Art. No.:
160802

The grid lamp has a mirror finish reflector with chrome grid for a downwards directed, glare free light.
The electrical connection of several lamps is possible.

ACCESSORY for Hang Up

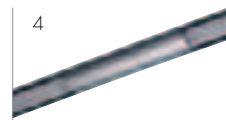
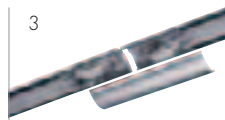
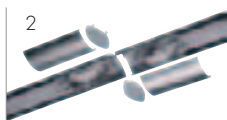
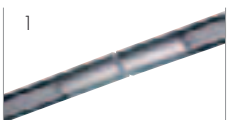

Longitudinal connector
silver grey

Art. No.:
160812

For a straight and mechanical connection of two lamps.

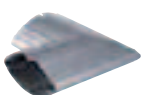

Corner connector
silver grey
L/W/H: 18/18/7 cm

Art. No.:
160822

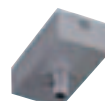

Canopy Tron
silver grey
L/W/H: 10/5,5/3 cm
Strain relief (incl.)

Art. No.:
925190



RIFFA PD-101/PD-102

230~

Series: Page 221

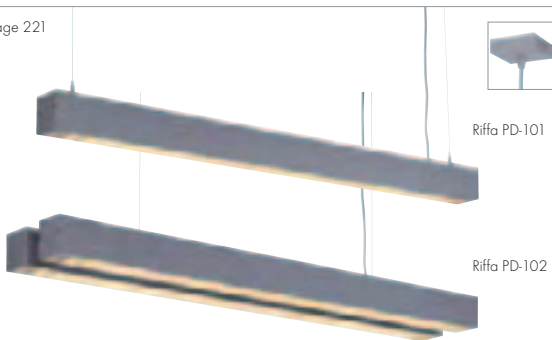

Riffa PD-101

Riffa PD-102

Socket/Bulb:
G5/T5 EnergySaver (excl.)
54W/2x 54W

Material:
Aluminium

Dimensions:
L/W/H: 120/7/8 cm (158304)
L/W/H: 120/18/8 cm (158314)
Canopy-L/W/H: 7,5/7,5/2,5 cm

Accessory/Included parts:
Electronic ballast (incl.)
Canopy (incl.)

Versions:
silver grey
Riffa PD-101

Riffa PD-102

Art. No.:
158304

158314

Recommended bulb:
54W, 3000K, 4450lm
548054

(PU see page 661)

The lamps can be connected with the longitudinal connector. For this purpose **one connector** for the Riffa PD-101 and **two connectors** for the Riffa PD-102 are needed.

ACCESSORY for Riffa PD-101/PD-102

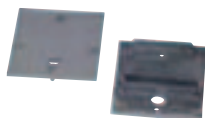

Longitudinal connector
silver grey
W/H/D: 7/8/0,5 cm

Art. No.:
158320

For a straight and mechanical connection of two lamps.

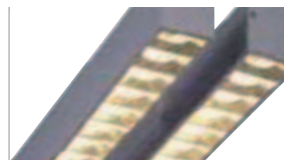

The pendant luminaires Riffa PD-101 and Riffa PD-102 are equipped with a Dark-Light grid, suitable for display work station according to DIN 5035-7. This allows an optimal illuminated work station and glare free light.



Q-LINE

Design by CDC

Series: Page 208



Q-LINE SINGLE

Design by CDC



230~



Socket/Bulb:
G5/T5 EnergySaver (excl.)
1x 35W

Versions:
white/chrome
alu natural/anthracite

Art. No.:
155011
155012

Material:
Aluminium anodized
Diffusor acrylic

Dimensions:
L/W/H: 151/5,7/9,8 cm
Canopy-L/W/H: 7,4/4/2,5 cm

Accessory/Included parts:
Electronic ballast (incl.)
Canopy (incl.)

Recommended bulb:
35W, 3000K, 3320lm
548035

(PU see page 661)

Q-LINE DOUBLE

Design by CDC



230~



Socket/Bulb:
G5/T5 EnergySaver (excl.)
2x 35W

Versions:
white/chrome
alu natural/anthracite

Art. No.:
155021
155022

Material:
Aluminium anodized
Diffusor acrylic

Dimensions:
L/W/H: 151/15,5/7,5 cm
Canopy-L/W/H: 7,4/4/2,5 cm

Accessory/Included parts:
Electronic ballast (incl.)
Canopy (incl.)

Recommended bulb:
35W, 3000K, 3320lm
548035

(PU see page 661)

ACCESSORY for Q-Line

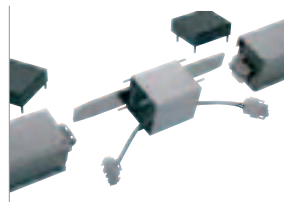

Longitudinal connector
white/chrome
alu natural
20 cm cable (incl.)
L/W/H: 6/5,7/5,1 cm

Art. No.:
155051
155052

For the straight connection of two
Q-Line profiles.







The illuminating part is steplessly pivoted 180°. Therefore the lamp can be used as uplight, downlight or wall light in suspended position.

OPEN GRILL SINGLE Design by CDC

230~



Socket/Bulb:
G5/T5 EnergySaver (excl.)
35W

Material:
Aluminium

Dimensions:
L/W/H: 162,5/4,5/4,5 cm
Canopy-L/W/H: 7,5/7,5/2,5 cm

Accessory/Included parts:
Electronic ballast (incl.)
Canopy (incl.)

Versions:
silver grey

Art. No.:
157494

Recommended bulb:
35W, 3000K, 3320lm
548035

(PU see page 661)

KUNO

230~



Series: Page 221

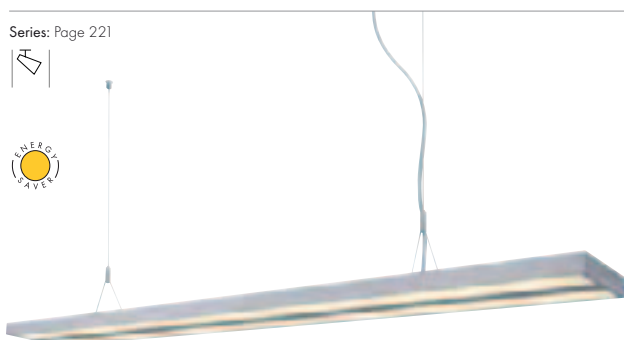

Socket/Bulb:
G5/T5 EnergySaver (excl.)
2x 35W

Material:
Aluminium
Diffusor PMMA

Dimensions:
L/W/H: 149/13,5/3 cm

Accessory/Included parts:
Electronic ballast (incl.)
Canopy (excl.)

Note:
With open cable end!
Canopy Tron must be ordered
separately.

Versions:
silver grey

Art. No.:
160832

Recommended bulb:
35W, 3000K, 3320lm
548035

(PU see page 661)

Recommended accessory:
Canopy Tron, silver grey
Strain relief (incl.)
L/W/H: 10/5,5/3 cm
925190





Duranz
Please note that the lamp is supplied with open cable end
and the canopy Tron must be ordered separately.

Worklight Wave PD-1

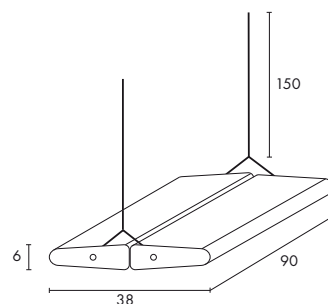
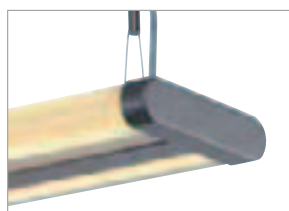

DURANZ



230~



Socket/Bulb:
G5/T5 EnergySaver (excl.)
2x 35W

Versions:
silver grey

Art. No.:
160874

Material:
Aluminium/PMMA

Dimensions:
L/W/H: 151/18/4 cm

Accessory/Included parts:
Electronic ballast (incl.)
Canopy (excl.)

Recommended bulb:
35W, 3000K, 3320lm
548035

(PU see page 661)

Recommended accessory:
Canopy Tron, silver grey
Strain relief (incl.)
L/W/H: 10/5,5/3 cm
925190



WORKLIGHT WAVE PD-1



230~



Socket/Bulb:
G5/T5 EnergySaver (excl.)
2x 39W

Versions:
silver grey

Art. No.:
157574

Material:
Aluminium/PMMA

Accessory/Included parts:
Electronic ballast (incl.)
Canopy (incl.)

Note:
Calculated acrylic diffuser from
BWF.

Series: Page 199



Recommended bulb:
39W, 3000K, 3220lm
548039

(PU see page 661)





i-LINE Pendant with one diffusor pane. The pane is not included in the delivery. Please order separately (see below).

TWINTUBE

230~



Socket/Bulb:
G5/T5 EnergySaver (excl.)
2x 39W

Material:
Plastic/aluminium
Tubes acrylic

Dimensions:
L/W/H: 91/19,5/10 cm
Tube-Ø: 4,3 cm
Canopy-L/W/H: 7,4/4/2,5 cm

Accessory/Included parts:
Electronic ballast (incl.)
Canopy (incl.)

Versions:
silver grey

Art. No.:
149222

Recommended bulb:
39W, 3000K, 3220lm
548039

(PU see page 661)

i-LINE PENDANT horizontal

230~



Socket/Bulb:
G5/T5 EnergySaver (excl.)
2x 39W

Material:
Aluminium

Dimensions:
L/W/H: 90/20,5/4 cm
Canopy-L/W/H: 7,4/4/2,5 cm

Accessory/Included parts:
Electronic ballast (incl.)
Canopy (incl.)
Diffusor pane (excl.)

Versions:
silver grey ▼

Art. No.:
157012

Recommended accessory:
Diffusor pane
L/W/H: 93/23,5/0,6 cm
1,5 kg, white, frosted
▼ 157031



Recommended bulb:
39W, 3000K, 3220lm
548039

(PU see page 661)



LED PANEL PD 115



Series: Page 218

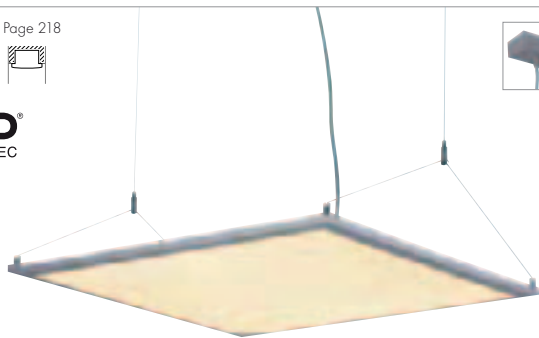
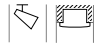

Socket/Bulb:
SMD LED
53W

Material:
Aluminium/acrylic

Dimensions:
L/W/H: 59,6/59,6/4,5 cm
Canopy-L/W/H: 7,4/4/2,5 cm

Accessory/Included parts:
Power supply (incl.)
Canopy (incl.)

Versions:
alu anodized, LED white
5500K, 2500lm
alu anodized, LED warm white
3000K, 2420lm

Art. No.:
158511
158512

LED PANEL LONG PD 116

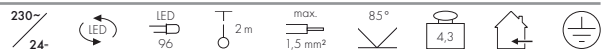

Series: Page 218

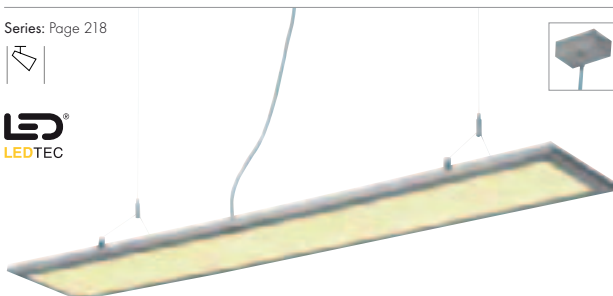

Bulb:
SMD LED
53W

Material:
Aluminium/acrylic

Dimensions:
L/W/H: 119,8/19,2/6 cm
Canopy-L/W/H: 7,4/4/2,5 cm

Accessory/Included parts:
Power supply (incl.)
Canopy (incl.)

Versions:
alu anodized, LED white
5500K, 2050lm
alu anodized, LED warm white
3000K, 1850lm

Art. No.:
158531
158532



OPEN GRILL Design by CDC

230~



Series: Page 217

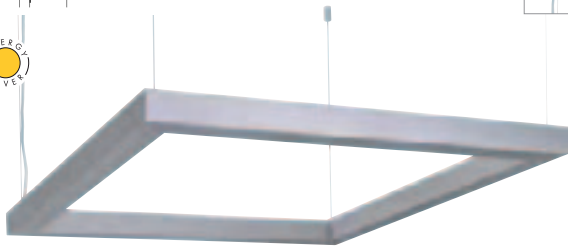

Socket/Bulb:
G5/T5 EnergySaver (excl.)
4x 24W

Material:
Aluminium

Dimensions:
L/W/H: 68/68/4,5 cm
Canopy-L/W/H: 7,5/7,5/2,5 cm

Accessory/Included parts:
Electronic ballast (incl.)
Canopy (incl.)

Versions:
silver grey

Art. No.:
157334

Recommended bulb:
24W, 3000K, 1700lm
548024

(PU see page 661)

T5 GRILL Pendant luminaire Design by CDC

230~



Series: Page 216



Socket/Bulb:
G5/T5 EnergySaver (excl.)
4x 24W

Material:
Aluminium /acrylic

Dimensions:
L/W/H: 60,5/60,5/6,5 cm
Canopy-L/W/H: 7,5/7,5/2,5 cm

Accessory/Included parts:
Electronic ballast (incl.)
Canopy (incl.)
Satiné acrylic pane (incl.)

Versions:
silver grey

Art. No.:
157102

Recommended bulb:
24W, 3000K, 1700lm
548024

(PU see page 661)

T5 GRILL QRB Design by CDC

230~
/12~

Socket/Bulb:
G5/T5 EnergySaver (excl.)
4x 24W
and
G53/QRB111 (excl.)
3x 50W max.

Material:
Aluminium/acrylic

Dimensions:
L/W/H: 60,5/60,5/6,5 cm
Canopy-L/W/H: 7,5/7,5/2,5 cm

Accessory/Included parts:
Electronic ballast (incl.)
Electronic transformer (incl.)
Canopy (incl.)
Satiné acrylic pane (incl.)

Versions:
silver grey

Art. No.:
157112

Recommended bulb:
24W, 3000K, 1700lm
548024

(PU see page 661)

Recommended bulb:
50W, 24°, 2700K, 2100cd
543524



The QRB111 and T5 bulbs can be switched separately.
Lamp may not be mounted within reach of hand.



AIXLIGHT® LONG MR16 Design by CDC



Series: Page 151

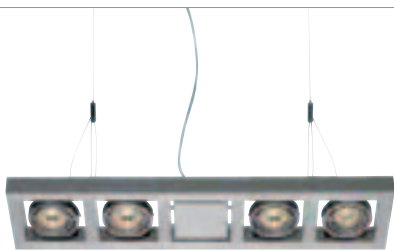

Socket/Bulb:
GU5,3/MR16 (excl.)
4x 50W max.

Versions:
silver grey

Art. No.:
154222

Material:
Aluminium

Dimensions:
L/W/H: 61/13/3 cm
Canopy-L/W/H: 7,4/4/2,5 cm

Recommended bulb:
50W, 40°, 2700K, 1500cd
535540



Accessory/Included parts:
Electronic transformer (incl.)
Canopy (incl.)



AIXLIGHT® SQUARE MR16 Design by CDC



Series: Page 151

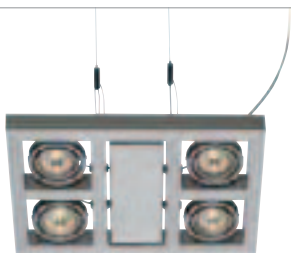

Socket/Bulb:
GU5,3/MR16 (excl.)
4x 50W max.

Versions:
silver grey

Art. No.:
154232

Material:
Aluminium

Dimensions:
L/W/H: 35/24/3 cm
Canopy-L/W/H: 7,4/4/2,5 cm

Recommended bulb:
50W, 40°, 2700K, 1500cd
535540



Accessory/Included parts:
Electronic transformer (incl.)
Canopy (incl.)



AIXLIGHT® LONG GU10 Design by CDC



Series: Page 151

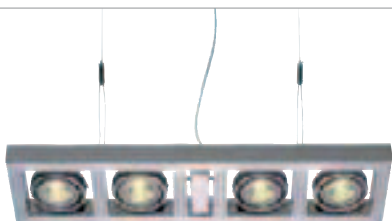

Socket/Bulb:
GU10/GU10 (excl.)
4x 50W max.

Versions:
silver grey

Art. No.:
154242

Material:
Aluminium

Dimensions:
L/W/H: 52,5/13/3 cm
Canopy-L/W/H: 7,4/4/2,5 cm

Recommended bulb:
35W EnergySaver ≠ 50W
20°, 2800K, 1200cd
575370



Accessory/Included parts:
Canopy (incl.)



AIXLIGHT® SQUARE GU10 Design by CDC



Series: Page 151

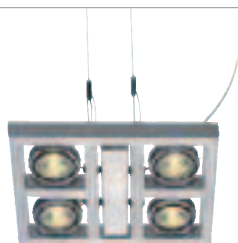

Socket/Bulb:
GU10/GU10 (excl.)
4x 50W max.

Versions:
silver grey

Art. No.:
154252

Material:
Aluminium

Dimensions:
L/W/H: 30,5/24/3 cm
Canopy-L/W/H: 7,4/4/2,5 cm

Recommended bulb:
35W EnergySaver ≠ 50W
20°, 2800K, 1200cd
575370



Accessory/Included parts:
Canopy (incl.)



ACCESSORY for Aixlight® MR16



Wall holder, short
silver grey/2 pce.
Total-L: 4,2 cm



Art. No.:
154302

ACCESSORY for Aixlight® MR16 and GU10



Wall and ceiling holder, long
silver grey/2 pce.
Total-H: 16 cm



Art. No.:
154312





AIXLIGHT® LONG QRB111 Design by CDC

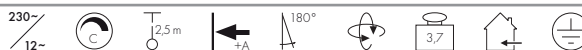

Series: Page 151

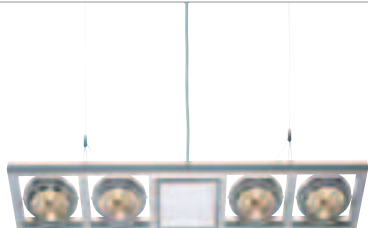

Socket/Bulb:
G53/QRB111 (excl.)
4x 50W max.

Versions:
silver grey

Art. No.:
154202

Material:
Aluminium

Dimensions:
L/W/H: 86,5/19/3 cm
Canopy-L/W/H: 7,4/4/2,5 cm

Recommended bulb:
50W EnergySaver \approx 75W
545752 24°, 3000K, 5800cd



Accessory/Included parts:
Electronic transformer (incl.)
Canopy (incl.)

AIXLIGHT® SQUARE QRB111 Design by CDC

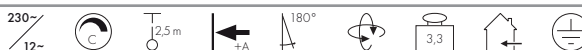

Series: Page 151

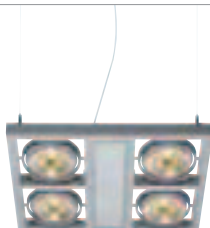

Socket/Bulb:
G53/QRB111 (excl.)
4x 50W max.

Versions:
silver grey

Art. No.:
154212

Material:
Aluminium

Dimensions:
L/W/H: 35,5/45/3 cm
Canopy-L/W/H: 7,4/4/2,5 cm

Recommended bulb:
50W EnergySaver \approx 75W
545752 24°, 3000K, 5800cd



Accessory/Included parts:
Electronic transformer (incl.)
Canopy (incl.)

ACCESSORY for Aixlight® QRB111



Wall holder, short
silver grey/2 pce.
Total L: 4,2 cm

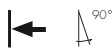

Art. No.:
154302



Wall and ceiling holder, long
silver grey/2 pce.
Total L: 16 cm



Art. No.:
154312



AIXLIGHT® DUO ES111 Design by CDC



Series: Page 151

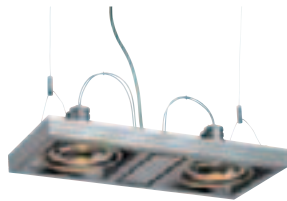

Socket/Bulb:
GU10/ES111 (excl.)
2x 75W max.

Versions:
silver grey

Art. No.:
154352

Material:
Aluminium

Dimensions:
L/W/H: 44/19/10 cm
Canopy-L/W/H: 7,4/4/2,5 cm

Recommended bulb:
75W, 24°, 2700K, 2000cd
575672



Accessory/Included parts:
Canopy (incl.)



AIXLIGHT® LONG ES111 Design by CDC



Series: Page 151

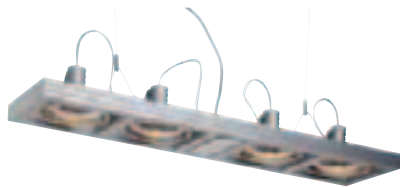

Socket/Bulb:
GU10/ES111 (excl.)
4x 75W max.

Versions:
silver grey

Art. No.:
154362

Material:
Aluminium

Dimensions:
L/W/H: 78/19/10 cm
Canopy-L/W/H: 7,4/4/2,5 cm

Recommended bulb:
75W, 24°, 2700K, 2000cd
575672



Accessory/Included parts:
Canopy (incl.)



AIXLIGHT® SQUARE ES111 Design by CDC



Series: Page 151

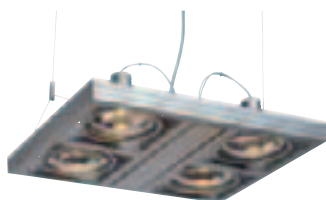

Socket/Bulb:
GU10/ES111 (excl.)
4x 75W max.

Versions:
silver grey

Art. No.:
154372

Material:
Aluminium

Dimensions:
L/W/H: 44/35,5/10 cm
Canopy-L/W/H: 7,4/4/2,5 cm

Recommended bulb:
75W, 24°, 2700K, 2000cd
575672



Accessory/Included parts:
Canopy (incl.)



AIXLIGHT® R DUO QRB111 Design by CDC



Series: Page 150



Socket/Bulb:
G53/QRB111 (excl.)
2x 50W max.

Material:
Aluminium

Dimensions:
L/W/H: 48/18/5 cm
Canopy-L/W/H: 8,5/8,5/2,7 cm

Accessory/Included parts:
Electronic transformer (incl.)
Canopy (incl.)

Versions:
black
white
silver grey

Art. No.:
159020
159021
159024

Recommended bulb:
35W EnergySaver \approx 50W
24°, 3000K, 4500cd
545522



AIXLIGHT® R LONG QRB111 Design by CDC



Series: Page 150

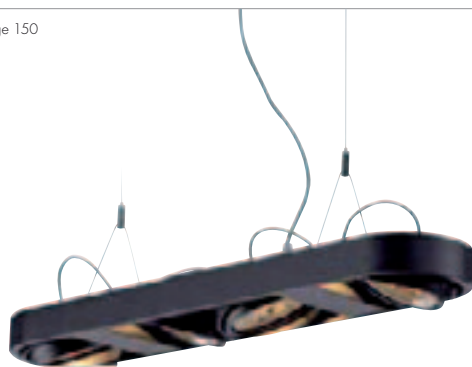

Socket/Bulb:
G53/QRB111 (excl.)
4x 50W max.

Material:
Aluminium

Dimensions:
L/W/H: 77/18/5 cm
Canopy-L/W/H: 8,5/8,5/2,7 cm

Accessory/Included parts:
Electronic transformer (incl.)
Canopy (incl.)

Versions:
black
white
silver grey

Art. No.:
159070
159071
159074

Recommended bulb:
35W EnergySaver \approx 50W
24°, 3000K, 4500cd
545522



AIXLIGHT® R DUO HQI 111 Design by CDC



Series: Page 150



HiEFFICIENT
PROFIlight.



Socket/Bulb:
G12/HQI-T (excl.)
2x 70W

Material:
Aluminium

Dimensions:
L/W/H: 48/18/15 cm
Canopy-L/W/H: 8,5/8,5/2,7 cm

Accessory/Included parts:
Electronic ballast (incl.)
Canopy (incl.)
Reflector (excl.)

Versions:
black
white
silver grey

Art. No.:
159040
159041
159044

Recommended bulb:
70W, 6600lm
507130 3000K, Ra84
507131 4200K, Ra92



Recommended accessory:
Reflectors for Duo HQI, alu polished
159200, 24°
159201, 38°
159202, 60°





AIXLIGHT® R2 DUO QRB111 Design by CDC



Series: Page 150



Socket/Bulb:
G53/QRB111 (excl.)
2x 50W max.

Material:
Aluminium

Dimensions:
L/W/H: 48/18/5 cm
Canopy-L/W/H: 8,5/8,5/2,7 cm

Accessory/Included parts:
Electronic transformer (incl.)
Canopy (incl.)

Versions:
black
white
silver grey

Art. No.:
159030
159031
159034

Recommended bulb:
35W EnergySaver \approx 50W
24°, 3000K, 4500cd
545522



AIXLIGHT® R2 LONG QRB111 Design by CDC



Series: Page 150

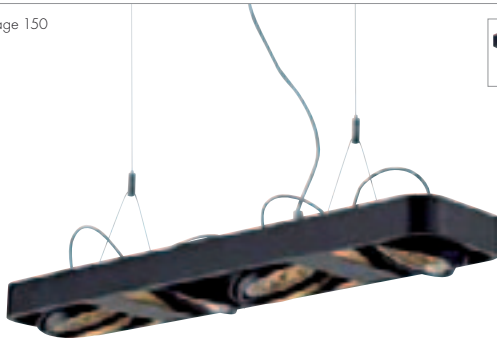

Socket/Bulb:
G53/QRB111 (excl.)
4x 50W max.

Material:
Aluminium

Dimensions:
L/W/H: 77/18/5 cm
Canopy-L/W/H: 8,5/8,5/2,7 cm

Accessory/Included parts:
Electronic transformer (incl.)
Canopy (incl.)

Versions:
black
white
silver grey

Art. No.:
159080
159081
159084

Recommended bulb:
35W EnergySaver \approx 50W
24°, 3000K, 4500cd
545522



AIXLIGHT® R2 SQUARE QRB111 Design by CDC



Series: Page 150



Socket/Bulb:
G53/QRB111 (excl.)
4x 50W max.

Material:
Aluminium

Dimensions:
L/W/H: 40/36/5 cm
Canopy-L/W/H: 8,5/8,5/2,7 cm

Accessory/Included parts:
Electronic transformer (incl.)
Canopy (incl.)

Versions:
black
white
silver grey

Art. No.:
159060
159061
159064

Recommended bulb:
35W EnergySaver \approx 50W
24°, 3000K, 4500cd
545522



AIXLIGHT® R2 DUO HQI 111 Design by CDC



Series: Page 150



PROFICIENT
light.



Socket/Bulb:
G12/HQI-T (excl.)
2x 70W

Material:
Aluminium

Dimensions:
L/W/H: 48/18/15 cm
Canopy-L/W/H: 8,5/8,5/2,7 cm

Accessory/Included parts:
Electronic ballast (incl.)
Canopy (incl.)
Reflector (excl.)

Versions:
black
white
silver grey

Art. No.:
159050
159051
159054

Recommended bulb:
70W, 6600lm
507130 3000K, Ra84
507131 4200K, Ra92



Recommended accessory:
Reflectoren for R2 Duo HQI, alu polished
159200, 24°
159201, 38°
159202, 60°





CYGNIS

LED-PENDANT LUMINAIRE



CYGNIS PD-1 Design by CDC

230~



LED
4 pce.

T 2m

120°



1,65



LED[®]
LEDTEC

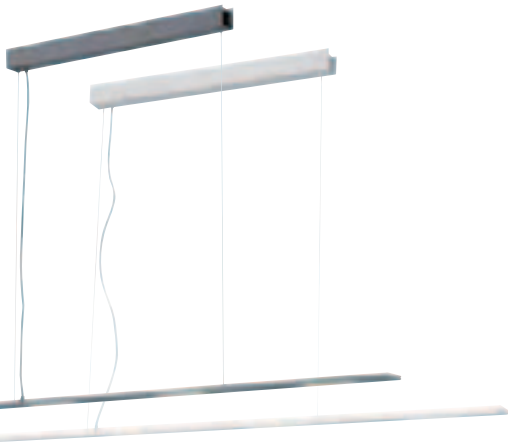

Socket/Bulb:
LED Line (incl.)
4x 4W, 16W total

Material:
Aluminium

Dimensions:
L/W/H: 121/5/0,9 cm
Canopy-L/W/H: 54/4,2/4,2 cm

Accessory/Included parts:
LED converter (incl.)

Versions:
LED warm white
3000K, Ra80+
white matt
silver grey

Art. No.:

157561
157564

NAVALIS

DIMMABLE PENDANT LUMINAIRE

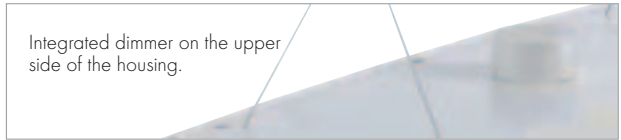

NAVALIS Design by CDC

230~

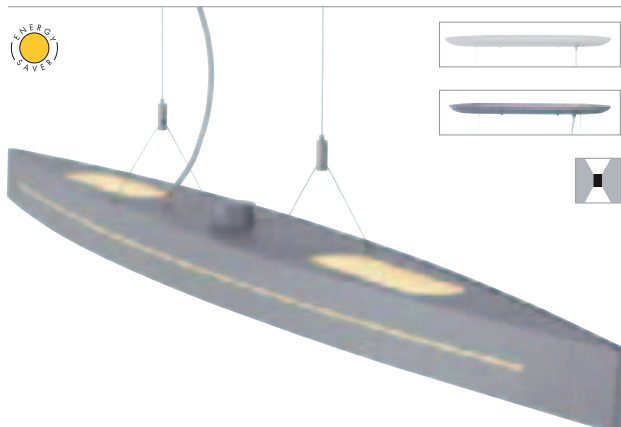

Socket/Bulb:
G5/T5 EnergySaver (excl.)
54W

Material:
Aluminium/polycarbonate

Dimensions:
L/W/H: 129,5/13,5/8 cm
Canopy-L/W/H: 58/5,1/2,8 cm

Accessory/Included parts:
Electronic ballast (incl.)
Canopy (incl.)

Note:
Integrated dimmer on the upper side of the housing.

Versions:
white
silver grey

Art. No.:
157801
157804

Recommended bulb:
54W, 3000K, 4450lm
548054

(PU see page 661)



OVO ES111



Socket/Bulb:
GU10/ES111 (excl.)
75W max.

Versions:
white/chrome

Art. No.:
133641

Material:
Steel

chrome

133642

Dimensions:
Ø/H: 13,5/24,5 cm
Canopy-Ø/H: 8,5/2 cm

Recommended bulb:
75W, 24°, 2700K, 2000cd
575672



Accessory/Included parts:
Canopy (incl.)

Note:
Ovo ES111 white:
Canopy white, clear cable.
Ovo ES111 chrome:
Canopy chrome, black textile cable.

Series: Page 047, 165, 252, 253, 276, 290

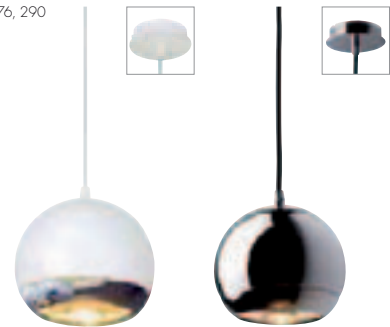

LIGHT EYE



Socket/Bulb:
GU10/ES111 (excl.)
75W max.
or
DomeLED ES111, 9W (excl.)

Versions:
white/chrome
chrome

Art. No.:
133481
133482

Material:
Steel

Recommended bulb:
75W, 24°, 2700K, 2000cd
575672



Dimensions:
Ø/H: 15/12 cm
Canopy-Ø/H: 8,5/2 cm

Accessory/Included parts:
Canopy (incl.)

Note:
Light Eye white:
Canopy white, clear cable.
Light Eye chrome:
Canopy chrome, black textile cable.

Recommended bulb:
DomeLED 9W, 60°, 176lm
550392 warm white







Series: Page 047, 165, 252, 253, 276, 290



LIGHT EYE X3



Socket/Bulb:
GU10/ES111 (excl.)
3x 75W max.

Versions:
chrome ▼

Art. No.:
133522

Material:
Steel

Dimensions:
Ø/H: 15/12 cm
Canopy-Ø/H: 8/3 cm

Recommended bulb:
75W, 24°, 2700K, 2000cd
575672



Accessory/Included parts:
Canopy, black textile cable (incl.)

Light Eye X3
Variable angle of radiation
through a height-adjustable
cable ring.



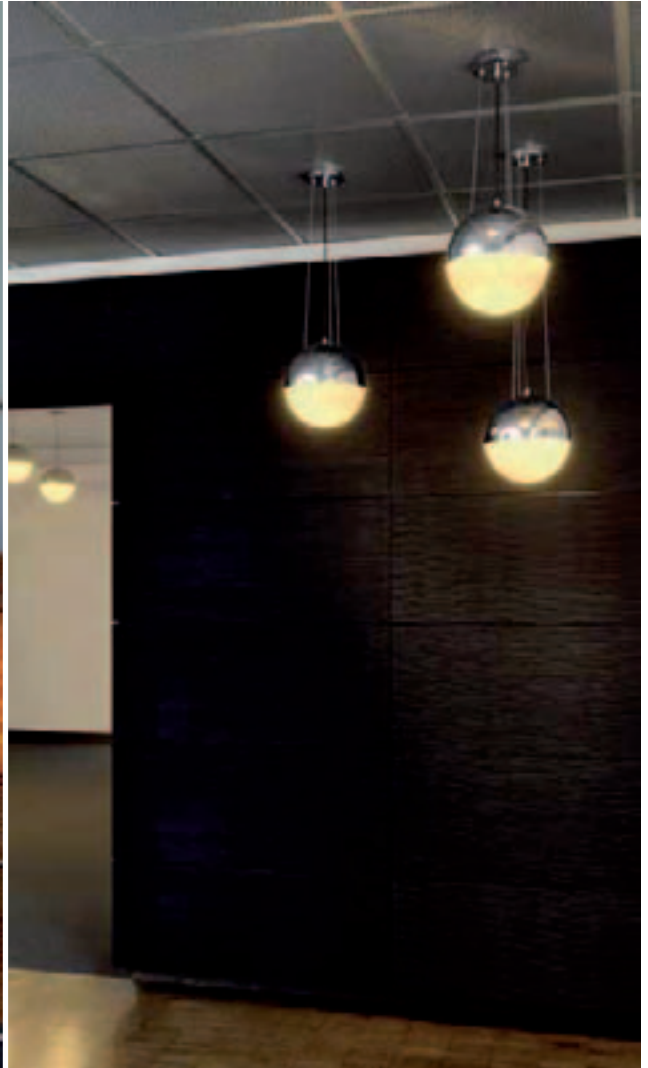

LIGHT EYE GLASS 4 Design by CDC



Socket/Bulb:
GX53/GX53 EnergySaver (excl.)
4x 9W max.

Versions:
chrome
Glass satined ▼

Art. No.:
133552

Material:
Steel/glass

Dimensions:
L/W/H: 68/15/16,8 cm
Canopy-Ø/H: 8,5/2 cm

Recommended bulb:
9W, 2700K, 260lm
508860



Accessory/Included parts:
Canopy, black textile cable (incl.)

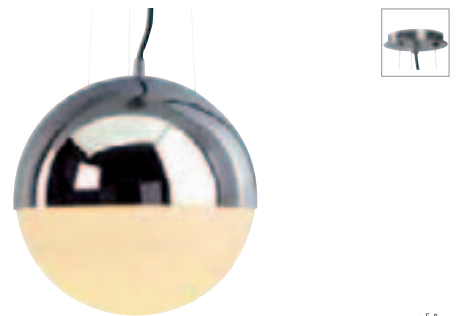

BIG LIGHT EYE Design by CDC



Socket/Bulb:
E27/AGL (excl.)
75W max.
or
E27/EnergySaver (excl.)
up to max. L: 17,5 cm

Versions:
chrome
Glass satined

Art. No.:
133562

Material:
Steel/glass

Dimensions:
Ø/H: 25,5/27,5 cm
Canopy-Ø/H: 13/2 cm

Recommended bulb:
23W, 2700K, 1350lm, EEK=A
508970



Accessory/Included parts:
Canopy (incl.)

Recommended bulb:
SMD LED 10W
2800K-3000K, 700lm, EEK=A
551342







SUN Pendant luminaire

230~



Series: Page 114



Socket/Bulb:
E27/AGL (excl.)
75W max.
or
E27/EnergySaver (excl.)
up to max. Ø/L: 7/12 cm

Material:
Aluminium/glass

Dimensions:
Ø/H: 19/19 cm
Canopy-Ø/H: 6/3 cm

Accessory/Included parts:
Canopy (incl.)

Note:
The lamp Sun is equipped with
a hand-blown glass shade.
Each lamp is an unique.

Versions:
alu/white

Art. No.:
133511

Recommended bulb:
15W, 2700K, 800lm, EEK=A
508960



BIG SUN Pendant luminaire

230~



Series: Page 114



Socket/Bulb:
E27/AGL (excl.)
75W max.
or
E27/EnergySaver (excl.)
up to max. Ø/L: 7/17,5 cm

Material:
Aluminium/glass

Dimensions:
Ø/H: 30/28 cm
Canopy-Ø/H: 8/3 cm

Accessory/Included parts:
Canopy (incl.)

Note:
The lamp Sun is equipped with
a hand-blown glass shade.
Each lamp is an unique.

Versions:
alu/white

Art. No.:
133581

Recommended bulb:
20W, 2700K, 1150lm, EEK=A
508830



ORION 40

230~



Socket/Bulb:
E27/AGL (excl.)
60W max.
or
E27/EnergySaver (excl.)
up to max. L: 16 cm

Material:
Steel/glass

Dimensions:
Ø/H: 40/20 cm
Canopy-Ø/H: 13/2,5 cm

Accessory/Included parts:
Canopy (incl.)

Versions:
chrome/glass satined

Art. No.:
133611

Recommended bulb:
20W, 2700K, 1150lm, EEK=A
508830





BARRO Design by CDC

 230~  1,5m  0,6  

Series: Page 162, 163



Socket/Bulb:
GU10/GU10 (excl.)
50W max.
or
GU10/EnergySaver (excl.)

Versions:
silver grey

Art. No.:
133432

Material:
Aluminium

Recommended bulb:
35W EnergySaver \approx 50W
20°, 2800K, 1200cd
575370



Dimensions:
Ø/H: 7/15 cm
Canopy-Ø/H: 8,5/2 cm

Accessory/Included parts:
Canopy (incl.)

BIG SURA SINGLE

 230~  1,5m   0,5  

Series: Page 115



Socket/Bulb:
G9/G9 (excl.)
40W max.

Versions:
chrome/white

Art. No.:
157252

Material:
Aluminium/ceramic

Recommended bulb:
33W EnergySaver \approx 40W
2700K, 460lm, EEC=C
519451



Dimensions:
Shade-Ø/H: 9/16,8 cm
Canopy-Ø/H: 8,5/2 cm

Accessory/Included parts:
Canopy (incl.)

PERRI

 230~  1,5m   1,0  

Socket/Bulb:
E27/AGL (excl.)
75W max.
or
E27/EnergySaver (excl.)
up to max. Ø/L: 7/16 cm

Versions:
alu/white

Art. No.:
133541

Material:
Aluminium/glass

Recommended bulb:
20W, 2700K, 1150lm, EEC=A
508830



Dimensions:
Ø/H: 11/20 cm
Canopy-Ø/H: 6/3 cm

Accessory/Included parts:
Canopy (incl.)





TONGA 1/4

230~



Tonga 1



Tonga 4

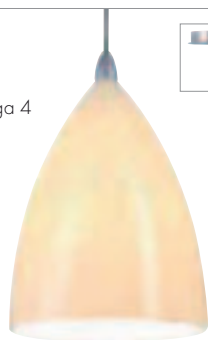

Socket/Bulb:

E14/AGL candle shape (excl.)
60W max.
or
E14/EnergySaver (excl.)
up to max. Ø/L: 5/13 cm

Material:

Tonga 1: glass
Tonga 4: ceramic

Dimensions:

Ø/H: 15/22 cm
Canopy-Ø/H: 8,5/2 cm

Accessory/Included parts:

Canopy (incl.)

Versions:

Tonga 1, glass
red-orange ▼

Tonga 4, ceramic
white

Art. No.:

133441

133444

Recommended bulb:

11W, 2700K, 530lm, EEK=A
508810



The lamp Tonga 1 is equipped with a hand-blown coloured glass shade.
Each lamp is an unique, whereby the marbling can vary.

BIBA 3

230~



Socket/Bulb:

E14/AGL candle shape (excl.)
60W max.
or
E14/EnergySaver (excl.)
up to max. Ø/L: 5/13 cm

Material:

Aluminium/glass

Dimensions:

Ø/H: 13/27 cm
Canopy-Ø/H: 8,5/2 cm

Accessory/Included parts:

Canopy (incl.)

Versions:

silver grey
Glass satined

Art. No.:

133464

Recommended bulb:

11W, 2700K, 530lm, EEK=A
508810





PIRUS

230~

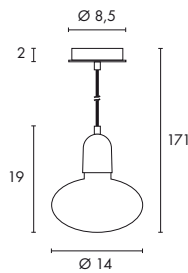

Socket/Bulb:
E14/AGL candle shape (excl.)
40W max.
or
E14/EnergySaver (excl.)
up to max. Ø/L: 3,8/11,7 cm

Material:
Aluminium/glass
Red textile-coated cable

Accessory/Included parts:
Canopy chrome (incl.)

Versions:
chrome
Glass satined

Art. No.:
133401

Recommended bulb:
7W, 2700K, 285lm, EEC=A
508800



SO-TOO

230~



Socket/Bulb:
E27/EnergySaver (excl.)
23W max.
up to max. Ø/L: 6,5/19 cm

Material:
Steel/glass

Dimensions:
Ø/H: 15/27 cm
Glass-Ø/H: 15/21 cm
Canopy-Ø/H: 8,5/2 cm

Accessory/Included parts:
Canopy (incl.)

Versions:
Glass satined
white
chrome

Art. No.:
133411
133412

Recommended bulb:
23W, 2700K, 1350lm, EEC=A
508970







COMMO PD-1

230~

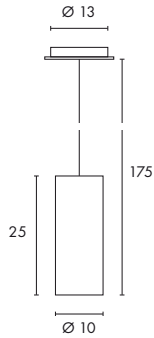

Socket/Bulb:
GX53/GX53 (excl.)
13W max.

Material:
Steel/glass

Dimensions:
Canopy-Ø/H: 13/3 cm

Accessory/Included parts:
Canopy (incl.)

Versions:
chrome
Glass clear/satined

Art. No.:
149380

Recommended bulb:
9W, 2700K, 260lm
508860



ENOLA

230~



Socket/Bulb:
E27/AGL (excl.)
60W max.
or
E27/EnergySaver (excl.)

Material:
Aluminium

Dimensions:
Ø/H: 10/32 cm
Canopy-Ø/H: 13/3 cm

Accessory/Included parts:
Canopy (incl.)

Versions:
white
alu brushed

Art. No.:
149381
149385

Recommended bulb:
75W, 24°, 5500cd
519727





CREST PD-1

Design by CDC

Series: Page 213



CREST PD-1

Design by CDC



230~



Socket/Bulb:
G5/T5 EnergySaver (excl.)
2x 24W

Versions:
chrome/white

Art. No.:
133780

The lamp can be suspended horizontal as well as vertical.

Material:
Zinc-cast chrome plated/PE

Dimensions:
Ø/L: 13,5/73 cm
Canopy-Ø/H: 12/3,2 cm

Recommended bulb:
24W, 3000K, 1700lm
548024

(PU see page 661)

Accessory/Included parts:
Electronic ballast (incl.)
Canopy (incl.)







ELSU | ISTU



Elsu



Istu
Two T8 ring tubes for a homogenous light effect.
The tubes can be switched separately.

ELSU



230~



Socket/Bulb:
G10q/T8-Ring EnergySaver (excl.)
32W

Versions:
alu brushed
Glass satined

Art. No.:
149365

Material:
Aluminium/glass

Dimensions:
Ø/H: 45/9 cm
Canopy-Ø/H: 13/3 cm

Recommended bulb:
32W, 3000K, 2375lm, EEK=B
548230



Accessory/Included parts:
Low-loss ballast (incl.)
Canopy (incl.)

ISTU



230~



Socket/Bulb:
G10q/T8-Ring EnergySaver (excl.)
1x 32W
1x 40W

Versions:
alu brushed
Glass satined

Art. No.:
149375

Material:
Aluminium/glass

Dimensions:
Ø/H: 45/9 cm
Canopy-Ø/H: 10/3 cm

Recommended bulb:
32W, 3000K, 2375lm, EEK=B
548230



Accessory/Included parts:
Low-loss ballast (incl.)
Canopy (incl.)

Recommended bulb:
40W, 3000K, 3200lm, EEK=B
548210



WHEEL PC Design by CDC

230~



Socket/Bulb:
G10q/T8-Ring EnergySaver (excl.)
40W
and
GU10/ES111 (excl.)
3x 50W max.

Material:
PC/steel

Dimensions:
Ø/H: 43,5/19 cm
Canopy-Ø/H: 10,5/5 cm

Accessory/Included parts:
Electronic ballast (incl.)
Canopy (incl.)

Note:
T8 ring tube and ES111 bulbs can
be switched separately.
Lamp may not be mounted within
reach of hand.

Versions:
silver grey/white

Art. No.:
149190

Recommended bulb:
50W, 2700K, 1300cd
575652



Recommended bulb:
40W, 3000K, 3200lm, EEK=B
548210



LIPSY® 1 Design by CDC

230~



Series: Page 125



Socket/Bulb:
G10q/T8-Ring EnergySaver (excl.)
1x 32W
1x 40W

Material:
PMMA

Dimensions:
Ø/H: 55/14,5 cm
Canopy-Ø/H: 12,5/2,5 cm

Accessory/Included parts:
Electronic ballast (incl.)
Canopy (incl.)

Note:
Two T8 ring tubes for a homogenous
light effect.

Versions:
white

Art. No.:
133721

Recommended bulb:
32W, 3000K, 2375lm, EEK=B
548230



Recommended bulb:
40W, 3000K, 3200lm, EEK=B
548210



LIPSY® 2 Design by CDC

230~



Series: Page 125



Socket/Bulb:
G10q/T8-Ring EnergySaver (excl.)
2x 32W
2x 40W

Material:
PMMA

Dimensions:
Ø/H: 55/29 cm
Canopy-Ø/H: 12,5/2,5 cm

Accessory/Included parts:
Electronic ballast (incl.)
Canopy (incl.)

Note:
Four T8 ring tubes for a
homogenous light effect. Upper
and bottom half can be switched
separately.

Versions:
white

Art. No.:
133722

Recommended bulb:
32W, 3000K, 2375lm, EEK=B
548230



Recommended bulb:
40W, 3000K, 3200lm, EEK=B
548210







MEDO

230~



Series: Page 121



Socket/Bulb:
2GX13/T5-Ring EnergySaver (excl.)
40W

Versions:
alu brushed
Glass satined

Art. No.:
149262

Material:
Aluminium/glass

Dimensions:
Ø/H: 38/9,5 cm
Canopy-Ø/H: 13/3 cm

Recommended bulb:
40W, 3000K, 3400lm, EEK=A
548240



Accessory/Included parts:
Electronic ballast (incl.)
Canopy (incl.)



TROMP PD-1

230~



Series: Page 122



Socket/Bulb:
E27/EnergySaver (excl.)
4x 23W max.
up to max. Ø: 5,2 cm

Versions:
alu brushed

Art. No.:
133622

Material:
Aluminium/acrylic

Dimensions:
Ø/H: 45/11 cm
Canopy-Ø/H: 14/2 cm

Recommended bulb:
21W, 2500K, 1230lm, EEK=A
508416



Note:
Not suitable for incandescent
lamps.



MEDO PRO 60

230~



Socket/Bulb:
2G11/TC-L EnergySaver (excl.)
2x 24W
and
G5/T5 EnergySaver (excl.)
2x 24W

Material:
Aluminium/acrylic

Dimensions:
Product-Ø/H: 60/11,5 cm

Accessory/Included parts:
Electronic ballast (incl.)
Suspension set (excl.)

Versions:
Acrylic satined
white
silver grey

Art. No.:
133801
133804

Recommended bulb:
24W, 4000K, 1800lm, EEK=A
508441

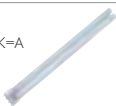

Recommended bulb:
24W, 4000K, 1700lm
548124



(PU see page 661)

SUSPENSION SET for Medo Pro 60

230~



Material:
Steel

Dimensions:
Canopy-Ø/H: 13/3 cm

Accessory/Included parts:
Set consisting of canopy, rope
suspending bracket as well as
1,8 m cable 3x 0,75mm².



Medo Pro 60 is a ceiling lamp, which can be modified to a pendant luminaire with the optionally available suspension set (see below).

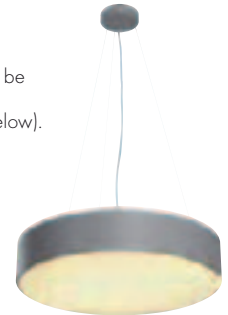



MALANG LED

T5 ring and RGB LED can be switched separately via external switches.
17 programs. Colour selectable.
Radio remote control to set the colour of the RGB LED.
Brightness and speed of colour can be controlled.
Details on the controller (470600) can be found in the accessory range.

The Malang LED is also available with a build-in Master/Slave functionality in order to reach a precise coloured synchronization of several lamps.
For this purpose you need the Master version (147203), which can be connected to any number of Slave versions (147213) via control lines and thus can be connected in series. Please pay attention, that the maximum distance from the last Slave-version to the Master-version is 30 Meter.



MALANG LED Design by CDC

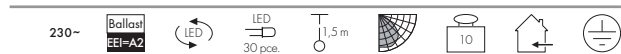

Socket/Bulb:
2GX13/T5-Ring EnergySaver (excl.)
40W
and
3in1 RGB LED SMD Strip (incl.)
8,5W

Material:
Aluminium/glass

Dimensions:
Ø/H: 48/25 cm
Canopy-Ø/H: 15/3,5 cm

Accessory/Included parts:
Electronic ballast (incl.)
LED converter (incl.)
Canopy (incl.)
Radio remote control (incl.)
12V battery (470620) for radio
remote control (incl.)
LED controller (incl.)

Versions:
metall brushed/white/RGB
Stand alone-Version **147223**
Master-Version **147203**

Slave-Version **147213**

Recommended bulb:
40W, 3000K, 3400lm, EEL=A
548240









ROTOBALL



ROTOBALL E27 Design by CDC



230~



Socket/Bulb:
E27/EnergySaver (excl.)
up to max. Ø: 9,5 cm
25W max.

Material:
Steel/polyethylene (PE)

Dimensions:
Ø: 50 cm
Canopy-Ø/H: 9,6/3,5 cm

Accessory/Included parts:
Canopy (incl.)

Version:
silver grey/white

Art. No.:
165400

Recommended bulb:
24W, 2500K, 1500lm, EEK=A
508417



ROTOBALL HIT Design by CDC



230~



Socket/Bulb:
G12/HQI-T, CDM-T (excl.)
150W

Material:
Steel/polyethylene (PE)

Dimensions:
Ø: 50 cm
Canopy-Ø/H: 9,6/3,5 cm

Accessory/Included parts:
Electronic ballast (incl.)
Canopy (incl.)

Version:
silver grey/white

Art. No.:
165420

Recommended bulb:
150W, 3000K, 15000lm
507440





PARA 380

silver grey/alu natural 165350
alu natural 165358

Material: Aluminium
Included parts: Canopy, chain (incl.), cable (excl.)

Recommended bulb:
20W, 2700K, 1150lm, EEK=A
508830

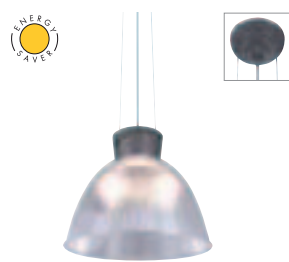

PARA DOME 2 E27

anthracite/transparent 165100

Material: Aluminium/PC
Included parts: Canopy (incl.)
Accessory: Reflector cover 330 (excl.)

Recommended bulb:
20W, 2700K, 1150lm, EEK=A
508830



Reflector cover 330
Product Ø: 33 cm
165160



Design by CDC PARA MULTI 406

silver grey 165340

Material: Steel/acrylic
Included parts: Canopy (incl.)

Recommended bulb:
20W, 2700K, 1150lm, EEK=A
508830



PARA LED

silver grey 165204

Material: Aluminium
Included parts: Canopy (incl.)

Recommended bulb:
PHILIPS Fortimo LED Twistable Module
18W, 4000K, 1100lm
560201



20W, 3000K, 1100lm
560202



PARA lamps for EnergySaver or LED technology

230~



Article No.	Description	Colour	Socket/ Bulb (excl.)	Wattage Bulb	Ø in cm	Height in cm	Canopy dimensions Ø/H in cm	Length of pendant cable in m	Weight in kg	Price
165350	Para 380	silver grey/alu natural	E27/AGL, HMLII or E27/EnergySaver	260W max.	38,0	40,0	9,0/2,5	1,0	1,10	
165358	Para 380	alu natural	E27/AGL, HMLII or E27/EnergySaver	260W max.	38,0	40,0	9,0/2,5	1,0	1,10	
165100	Para Dome 2 E27	anthracite/transparent	E27/AGL or E27/EnergySaver	150W max.	33,0	30,0	12,5/3,5	1,5	1,40	
165340	Para Multi 406	silver grey	E27/AGL, HMLII or E27/EnergySaver	160W max.	41,0	39,0	8,0/2,7	3,0	3,00	
165204	Para LED	silver grey	-/ Philips Fortimo LED Twistable Module	18W/20W	32,0	29,5	11,0/5,0	1,5	1,28	

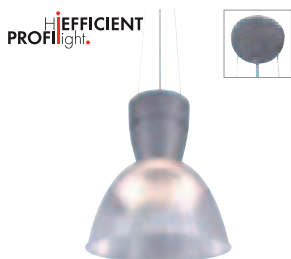

PARA DOME 2 HQI

70W 165110

Material: Aluminium/PC
Included parts: Conventional ballast, canopy (incl.)
Accessory: Reflector cover 330 (excl.)

Recommended bulb:
 70W, 3800K
 508171



Reflector cover 330
 Product-Ø: 33 cm
 165160





PARA DOME 2 HQI

250W 165140

Material: Aluminium/PC
Included parts: Conventional ballast (incl.), Canopy, Chain, Cable (excl.)
Accessory: Reflector cover 480 (excl.)

Recommended bulb:
 250W, 4200K, 20000lm
 509180



Reflector cover 480
 Product-Ø: 48 cm
 165161





Design by CDC
PARA MULTI 406 BALLAST

70W 165330
 150W 165320

Material: Steel/acrylic
Included parts: Ballast: 70W-Electronic ballast/150W-Conventional ballast (incl.), Canopy (incl.)

Recommended bulb:
 70W, 3800K
 508171



Recommended bulb:
 150W, 4000K, 12500lm
 509171



PARA professional lamps for commercial use

230~ 

Article No.	Description	Colour	Socket/ Bulb (excl.)	Wattage Bulb	Ø in cm	Height in cm	Canopy dimensions Ø/H in cm	Length of pendant cable in m	Energy efficiency category ballast	Weight in kg	Price
165110	Para Dome 2 HQI 70W	anthracite/transparent	E27/HQIE	70W	33,0	42,0	12,5/3,5	1,5	EEl=A3	3,55	
165140	Para Dome 2 HQI 250W	silver grey	E40/HQIE	250W	48,0	56,0	-	-	EEl=A3	6,85	
165330	Para Multi 406 Elec. ballast 70W	silver grey	E27/HQIE	70W	41,0	39,0	8,0/2,7	3,0	EEl=A3	3,06	
165320	Para Multi 406 Ballast 150W	silver grey	E27/HQIE	150W	41,0	39,0	8,0/2,7	3,0	EEl=A2	5,00	



WALL AND CEILING LUMINAIRES

Luminaires for
low-voltage bulbs
QRB111



144



141



142



148



152



149



151



150



150



147

Luminaires for
high-voltage bulbs
G9



115



115



115



135

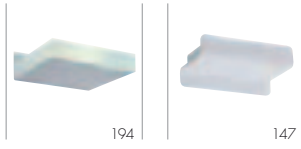
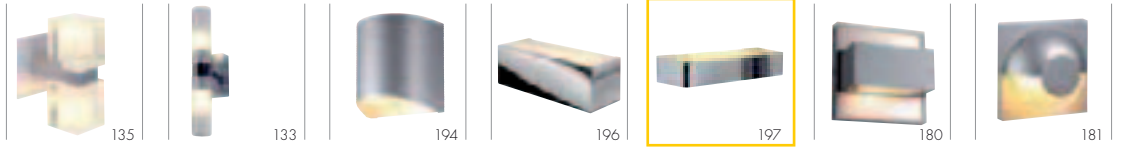

Luminaires for high-voltage bulbs GU10

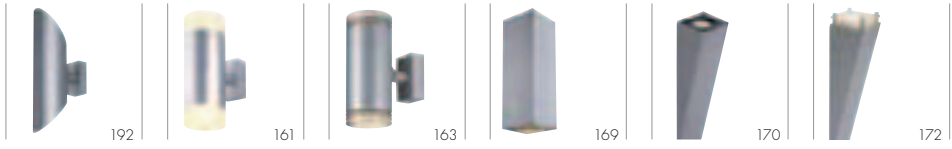
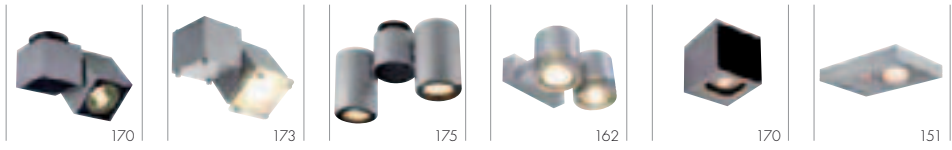

Luminaires for high-voltage bulbs ES111

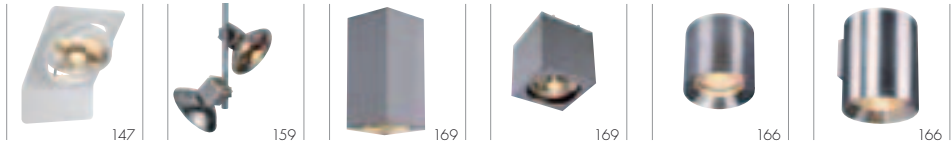

Luminaires for high-voltage bulbs R7s



Luminaires for high-voltage line bulbs S14d



Luminaires for energy-saving bulbs



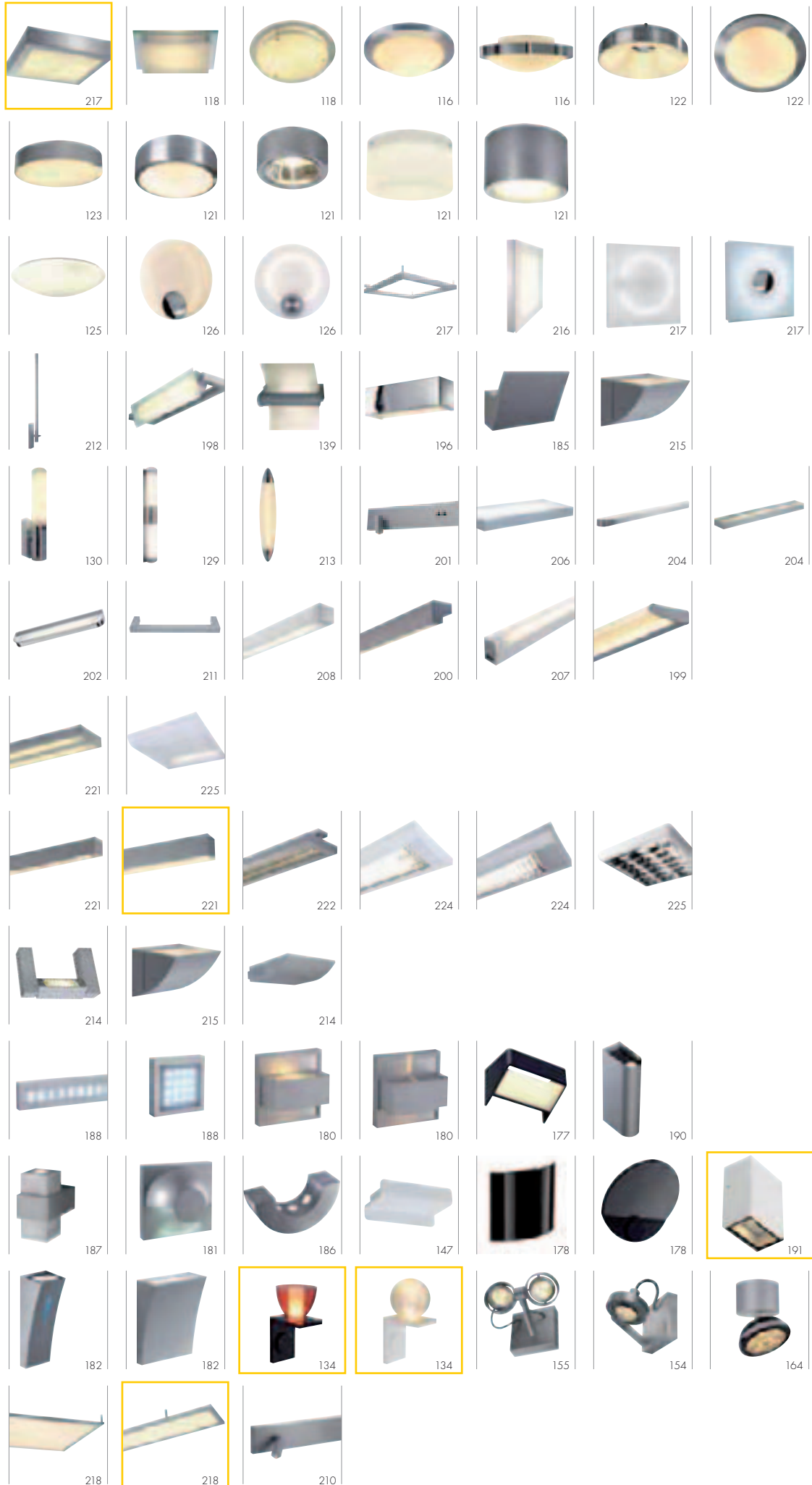



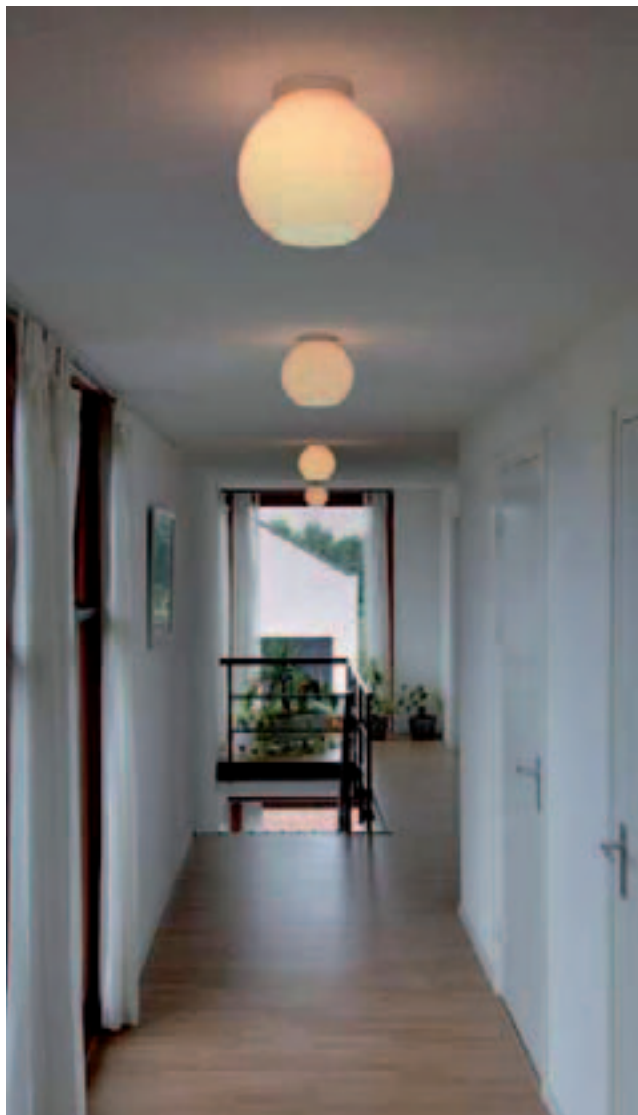

Series: Page 089



BIG SUN CEILING Design by CDC



230~



Socket/Bulb:
E27/AGL (excl.)
75W max.
or
E27/EnergySaver (excl.)
up to max. Ø/L: 7/17,5 cm

Accessory/Included parts:
Canopy (incl.)

Versions:
alu/white

Art. No.:
134301

Material:
Aluminium/glass

Dimensions:
Ø/H: 30/30 cm
Canopy-Ø/H: 11/2 cm

Recommended bulb:
20W, 2700K, 1150lm, EEK=A
508830



Series: Page 089



SUN CEILING Design by CDC



230~



Socket/Bulb:
E27/AGL (excl.)
75W max.
or
E27/EnergySaver (excl.)
up to max. Ø/L: 7/12 cm

Accessory/Included parts:
Canopy (incl.)

Versions:
alu/white

Art. No.:
134221

Material:
Aluminium/glass

Dimensions:
Ø/H: 19/19,5 cm
Canopy-Ø/H: 11/2 cm

Recommended bulb:
15W, 2700K, 800lm, EEK=A
508960



Note:
Hand-blown glass shade by Sun and Big Sun.
Each lamp is an unique.



ORION PLATE

230~



Socket/Bulb:
G9/G9 (excl.)
40W max.
or
G9/EnergySaver (excl.)

Material:
Steel/glass

Dimensions:
Product-Ø/H: 17,5/15 cm
Plate-Ø: 17,5 cm
Glass-Ø/H: 12,5/10 cm

Accessory/Included parts:
Canopy (incl.)

Versions:
Glass white
silver grey
chrome

Art. No.:
134201
134261

Recommended bulb:
33W EnergySaver \approx 40W
2700K, 460lm, EEK=C
519451



Recommended bulb:
9W, 2700K, 405lm, EEK=A
508940



COMMO CL-1

230~



Series: Page 095



Socket/Bulb:
GX53/GX53 EnergySaver (excl.)
13W max.

Material:
Steel/glass

Dimensions:
Ø/H: 10/15 cm

Versions:
Glass satined
chrome

Art. No.:
134310

Recommended bulb:
9W, 2700K, 260lm
508860



BIG SURA CEILING Design by CDC

230~



Series: Page 091



Socket/Bulb:
G9/G9 (excl.)
60W max.

Material:
Steel/ceramic

Dimensions:
Shade-Ø/H: 9/9,5 cm
Canopy-Ø/H: 15/1,6 cm

Accessory/Included parts:
Canopy (incl.)

Versions:
chrome/white

Art. No.:
157232

Recommended bulb:
33W EnergySaver \approx 40W
2700K, 460lm, EEK=C
519451



BLOX

230~



Socket/Bulb:
G9/G9 (excl.)
40W max.

Material:
Steel/glass

Dimensions:
Glass-L/W/H: 6,7/6,7/6,7 cm
Canopy-L/W: 9,5/9,5 cm
Total-H: 9 cm

Accessory/Included parts:
Canopy (incl.)

Versions:
Glass clear
chrome

Art. No.:
151240

Recommended bulb:
33W EnergySaver \approx 40W
2700K, 460lm, EEK=C
519451





WL 103 E14

230~



IP23

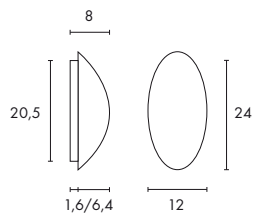

Socket/Bulb:
E14/AGL (excl.)
40W max.
or
E14/EnergySaver (excl.)
up to max. Ø/L: 4/13 cm

Material:
Steel/glass

Versions:
Glass satined
white

Art. No.:
155240

Recommended bulb:
11W, 2700K, 530lm, EEK=A
508810



WL 104 E27

230~



IP23

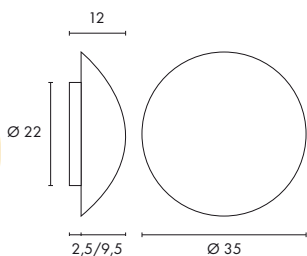

Socket/Bulb:
E27/AGL (excl.)
60W max.
or
E27/EnergySaver (excl.)
up to max. L: 17 cm

Material:
Steel/glass

Versions:
Glass satined
white

Art. No.:
155250

Recommended bulb:
PHILIPS Master Stairway ELT 15W
2700K, 850lm, Ra82, EEK=A
508600



MELAN

230~



IP23



Socket/Bulb:
E27/AGL (excl.)
60W max.
or
E27/EnergySaver (excl.)
up to max. Ø/L: 7/16 cm

Material:
Aluminium/glass

Dimensions:
Ø/H: 32/10 cm

Versions:
Glass satined
alu brushed

Art. No.:
155236

Recommended bulb:
15W, 2700K, 800lm, EEK=A
508960



CORONA CL-1

230~



IP21



Socket/Bulb:
E27/AGL (excl.)
60W max.
or
E27/EnergySaver (excl.)
up to max. L: 13,7 cm

Material:
Aluminium/steel/glass

Dimensions:
Ø/H: 30/10 cm

Versions:
Glass satined
chrome

Art. No.:
155272

Recommended bulb:
20W, 2700K, 1200lm, EEK=A
508760







GLASSA

CEILING LUMINAIRE SERIES

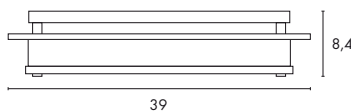

GLASSA Square

GLASSA SQUARE TC-DE

230~

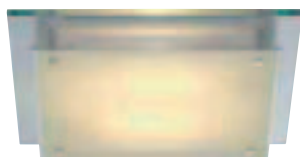

Socket/Bulb:
G24q-3/TC-DE EnergySaver (excl.)
2x 26W

Material:
Glass/steel

Dimensions:
L/W/H: 39/39/8,4 cm

Accessory/Included parts:
Electronic ballast (incl.)

Versions:
Glass satined

Art. No.:
155190

Recommended bulb:
26W, 3000K, 1800lm, EEK=B
508222



GLASSA ROUND TC-DE

230~



Socket/Bulb:
G24q-3/TC-DE EnergySaver (excl.)
2x 26W

Material:
Glass/steel

Dimensions:
Ø/H: 40/8,5 cm

Accessory/Included parts:
Electronic ballast (incl.)

Versions:
Glass satined

Art. No.:
155195

Recommended bulb:
26W, 3000K, 1800lm, EEK=B
508222



GLASSA SQUARE E27

230~

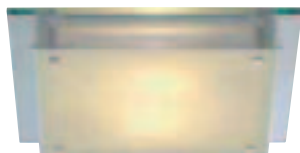

Socket/Bulb:
E27/AGL (excl.)
2x 60W max.
or
E27/EnergySaver (excl.)
up to max. Ø/L: 4,8/14,8 cm

Material:
Glass/steel

Dimensions:
L/W/H: 39/39/8,4 cm

Versions:
Glass satined

Art. No.:
155180

Recommended bulb:
20W, 2700K, 1200lm, EEK=A
508760



GLASSA ROUND E27

230~



Socket/Bulb:
E27/AGL (excl.)
2x 60W max.
or
E27/EnergySaver (excl.)
up to max. Ø/L: 4,8/13,6 cm

Material:
Glass/steel

Dimensions:
Ø/H: 40/8,5 cm

Versions:
Glass satined

Art. No.:
155185

Recommended bulb:
20W, 2700K, 1200lm, EEK=A
508760









CL 101 GX53

230~

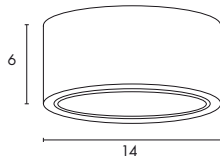

Socket/Bulb:
GX53/GX53 EnergySaver (excl.)
11W max.

Material:
Plastic

Versions:
white
silver grey

Art. No.:
112281
112284

Recommended bulb:
9W, 2700K, 260lm
508860



TUBE Design by CDC

230~



Socket/Bulb:
G24d-3/TC-D EnergySaver (excl.)
2x 26W

Material:
Steel/glass

Dimensions:
Ø/H: 25/14 cm

Accessory/Included parts:
Low-loss ballast (incl.)

Versions:
Glass satined
white/chrome

Art. No.:
161441

Recommended bulb:
26W, 2700K, 1800lm, EEK=B
508226



PL SURFACE MOUNTED CEILING LUMINAIRE 2x 26W

230~



Socket/Bulb:
G24d-3/TC-D EnergySaver (excl.)
2x 26W

Material:
Aluminium/glass

Dimensions:
Ø/H: 23,5/15,5 cm

Accessory/Included parts:
Low-loss ballast (incl.)

Versions:
Glass satined
white
silver grey

Art. No.:
161431
161434

Recommended bulb:
26W, 2700K, 1800lm, EEK=B
508226



MEDO

230~



Series: Page 102



Socket/Bulb:
2GX13/T5-Ring EnergySaver (excl.)
40W

Material:
Aluminium/glass

Dimensions:
Ø/H: 38/9,5 cm

Accessory/Included parts:
Electronic ballast (incl.)

Versions:
Glass satined
alu natural

Art. No.:
149252

Recommended bulb:
40W, 3000K, 3400lm, EEK=A
548240





CL 135 T5 R

230~

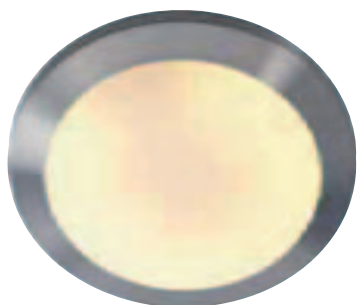

Socket/Bulb:
2GX13/T5-Ring EnergySaver (excl.)
40W

Material:
Aluminium/steel/plastic

Dimensions:
Ø/H: 45/10,5 cm

Accessory/Included parts:
Electronic ballast (incl.)

Versions:
alu brushed/white

Art. No.:
133760

Recommended bulb:
40W, 3000K, 3400lm, EEK=A
548240



TROMP CL-1

230~



Series: Page 102



Socket/Bulb:
E27/EnergySaver (excl.)
up to max. Ø: 5,2 cm
4x 23W max.

Material:
Aluminium/acrylic

Dimensions:
Ø/H: 45/11 cm

Note:
Not suitable for incandescent
lamps.

Versions:
alu brushed/white

Art. No.:
133620

Recommended bulb:
21W, 2500K, 1230lm, EEK=A
508416





MEDO PRO 60



230~



Socket/Bulb:
2G11/TC-L EnergySaver (excl.)
2x 24W
and
G5/T5 EnergySaver (excl.)
2x 24W

Material:
Aluminium/acrylic

Dimensions:
Product-Ø/H: 60/11,5 cm

Accessory/Included parts:
Electronic ballast (incl.)

Versions:
Acrylic satined
white
silver grey

Art. No.:
133801
133804

Can be modified with the
suspension set into a pendant
luminaire (see page 103).
white 133811
silver grey 133814

Recommended bulb:
24W, 4000K, 1800lm, EEK=A
508441



Recommended bulb:
24W, 4000K, 1700lm
548124



(PU see page 661)



LOUISSE 1

230~

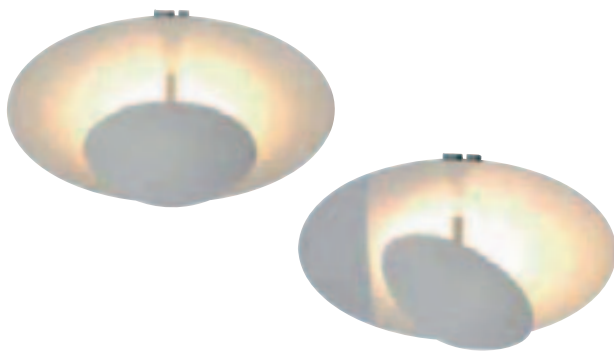

Socket/Bulb:
R7s/R7s, 118 mm (excl.)
200W max.

Material:
Steel

Dimensions:
Ø/H: 40/13,5 cm

Note:
Light exit is adjustable by 90° due to a small shell.

Versions:
white

Art. No.:
133901

Recommended bulb:

PHILIPS Plusline ES
160W EnergySaver ≈ 200W
2900K, 3100lm, EEL=C
519241

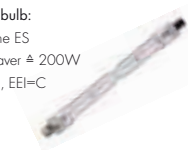

LOUISSE 2

230~



Socket/Bulb:
R7s/R7s, 118 mm (excl.)
200W max.

Material:
Steel

Dimensions:
Ø/H: 40/16,5 cm

Versions:
white

Art. No.:
133911

Recommended bulb:

PHILIPS Plusline ES
160W EnergySaver ≈ 200W
2900K, 3100lm, EEL=C
519241





LIPSY® Design by CDC

230~



Series: Page 100



Two T8 ring tubes ensure a homogenous light effect.

Socket/Bulb:
G10q/T8-Ring EnergySaver (excl.)
1x 32W
1x 40W

Material:
Steel
Shade PMMA

Dimensions:
Ø/H: 55/14,5 cm

Accessory/Included parts:
Electronic ballast (incl.)

Versions:
white

Art. No.:
133723

Recommended bulb:
32W, 3000K, 2375lm, EEK=B
548230



Recommended bulb:
40W, 3000K, 3200lm, EEK=B
548210



LIPSY® OUT CEILING

230~



IP23



Socket/Bulb:
E27/EnergySaver (excl.)
up to max. L: 11,6 cm
23W max.

Material:
Acryl/steel

Dimensions:
Ø/H: 34/20,5 cm

Note:
To avoid a heat accumulation, no incandescent bulbs may be used.

Versions:
white

Art. No.:
227351

Recommended bulb:
15W, 2700K, 800lm, EEK=A
508960





SAINT 22 Design by CDC

230~



Socket/Bulb:
2GX13/T5-Ring EnergySaver (excl.)
22W

Material:
Aluminium/glass

Dimensions:
Ø/D: 32/8,5 cm
Glass-Ø/D: 32/0,4 cm
Canopy-Ø/D: 10/7 cm

Accessory/Included parts:
Electronic ballast (incl.)

Versions:
Glass satined
alu brushed

Art. No.:
149401

Recommended bulb:
22W, 3000K, 1900lm, EEK=A
548220



AENEA WALL Design by CDC

230~



Socket/Bulb:
G10q/T8-Ring EnergySaver (excl.)
40W

Material:
PC/steel

Dimensions:
Ø/H: 43/9 cm

Accessory/Included parts:
Electronic ballast (incl.)

Versions:
white/chrome

Art. No.:
149180

Recommended bulb:
40W, 3000K, 3200lm, EEK=B
548210









Z 211

230~     



Socket/Bulb:
G23/TC-S EnergySaver (excl.)
2x 11W

Material:
Steel/glass

Dimensions:
W/H/D: 9/58/7,5 cm

Accessory/Included parts:
Low-loss ballast (incl.)

Versions:
Glass partial satined
metal brushed

Art. No.:
147455

Recommended bulb:
11W, 2700K, 900lm, EEK=A
508310



LINE Design by CDC

230~     

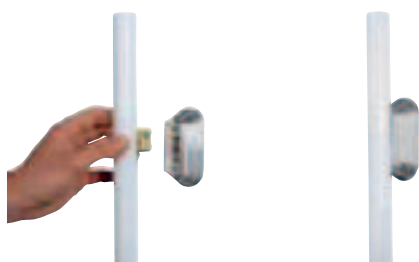

Socket/Bulb:
S14d/line bulb (excl.)
35/60W

Material:
Plastic

Dimensions:
Socket-W/H/D: 4,7/10,2/3,8 cm

Recommended bulb:
35W, 2700K, 270lm, EEK=F
30 cm, matt
590150



Versions:
Armature for line bulb
chrome

Art. No.:
160702

Recommended bulb:
60W, 2700K, 420lm, EEK=G
50 cm, matt
590151





CALMA IP44



230~



Socket/Bulb:
G23/TC-S EnergySaver (excl.)
11W

Versions:
chrome/white

Art. No.:
151442

Material:
Steel/brass/acrylic

Dimensions:
W/H/D: 6/39/9,5 cm
Shade-Ø/H: 6/24,5 cm

Accessory/Included parts:
Low-loss ballast (incl.)

Recommended bulb:
11W, 2700K, 900lm, EEK=A
508310



DEVIN DOUBLE



230~



Socket/Bulb:
E14/EnergySaver (excl.)
2x 11W max.
up to max. Ø/L: 4/14 cm

Versions:
chrome/white

Art. No.:
151552

Material:
Steel/glass

Dimensions:
Ø/H/D: 6,5/46,5/9,5 cm
Glass-Ø/H: 6,5/16 cm
Canopy-W/H/D: 4,5/14,5/2 cm

Recommended bulb:
11W, 2700K, 530lm, EEK=A
508810



WL 105

230~



IP44



Socket/Bulb:
E14/AGL candle shape (excl.)
40W max.
or
E14/EnergySaver (excl.)
up to max. Ø/L 3,6/11 cm

Material:
Aluminium/steel/glass

Dimensions:
W/H/D: 9,5/26/11 cm
Glass-Ø/H: 7/18,5 cm
Canopy-Ø/H: 9,5/2,5 cm

Versions:
chrome

Art. No.:
149482

Recommended bulb:
11W, 2700K, 530lm, EEK=A
508810

WL 106

230~



IP44



Socket/Bulb:
E14/AGL candle shape (excl.)
2x 40W max.
or
E14/EnergySaver (excl.)
up to max. Ø/L 3,6/11 cm

Material:
Aluminium/steel/glass

Dimensions:
W/H/D: 9,5/41/11 cm
Glass-Ø/H: 7/18,5 cm
Canopy-Ø/H: 9,5/2,5 cm

Versions:
chrome

Art. No.:
149492

Recommended bulb:
11W, 2700K, 530lm, EEK=A
508810





DENA 1



Socket/Bulb:
E14/AGL candle shape (excl.)
40W max.
or
E14/EnergySaver (excl.)
up to max. Ø/L: 5/9,6 cm

Material:
Aluminium/glass

Dimensions:
W/H/D: 8/20/10 cm

Versions:
Glass satined
alu brushed

Art. No.:
147519

Recommended bulb:
11W, 2700K, 575lm, EEK=A
508630



DENA 2



Socket/Bulb:
E14/AGL candle shape (excl.)
2x 40W max
or
E14/EnergySaver (excl.)
up to max. Ø/L: 5/9,6 cm

Material:
Aluminium/glass

Dimensions:
W/H/D: 8/30/10 cm

Versions:
Glass satined
alu brushed

Art. No.:
147529

Recommended bulb:
11W, 2700K, 575lm, EEK=A
508630



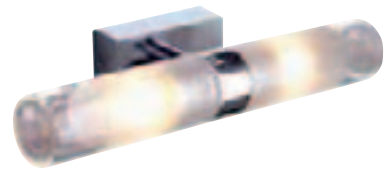

MIBO WALL UP-DOWN Design by FGL



230~



IP21



Socket/Bulb:
G9/G9 (excl.)
2x 25W max.

Versions:
Glass partial satined
chrome

Art. No.:
151282

Material:
Aluminium/glass

Dimensions:
W/H/D: 23/4/8,5 cm
Glass-Ø: 3,5 cm

Recommended bulb:
20W EnergySaver \approx 25W
2700K, 200lm, EEK=D
519450





RED 4W LED

230~  1 pce.   0,58  

 LEDTEC



Bulb:
PowerLED (incl.)
1x 4W

Material:
Aluminium/glass

Dimensions:
W/H/D: 10/19,5/11 cm

Versions:
black/red
LED 3000K, 200lm

Art. No.:
151200

ICE 4W LED

230~  1 pce.   0,57  

 LEDTEC



Bulb:
PowerLED (incl.)
1x 4W

Material:
Aluminium/glass

Dimensions:
W/H/D: 9,5/21,5/11 cm

Versions:
white
LED 3000K, 200lm

Art. No.:
151211

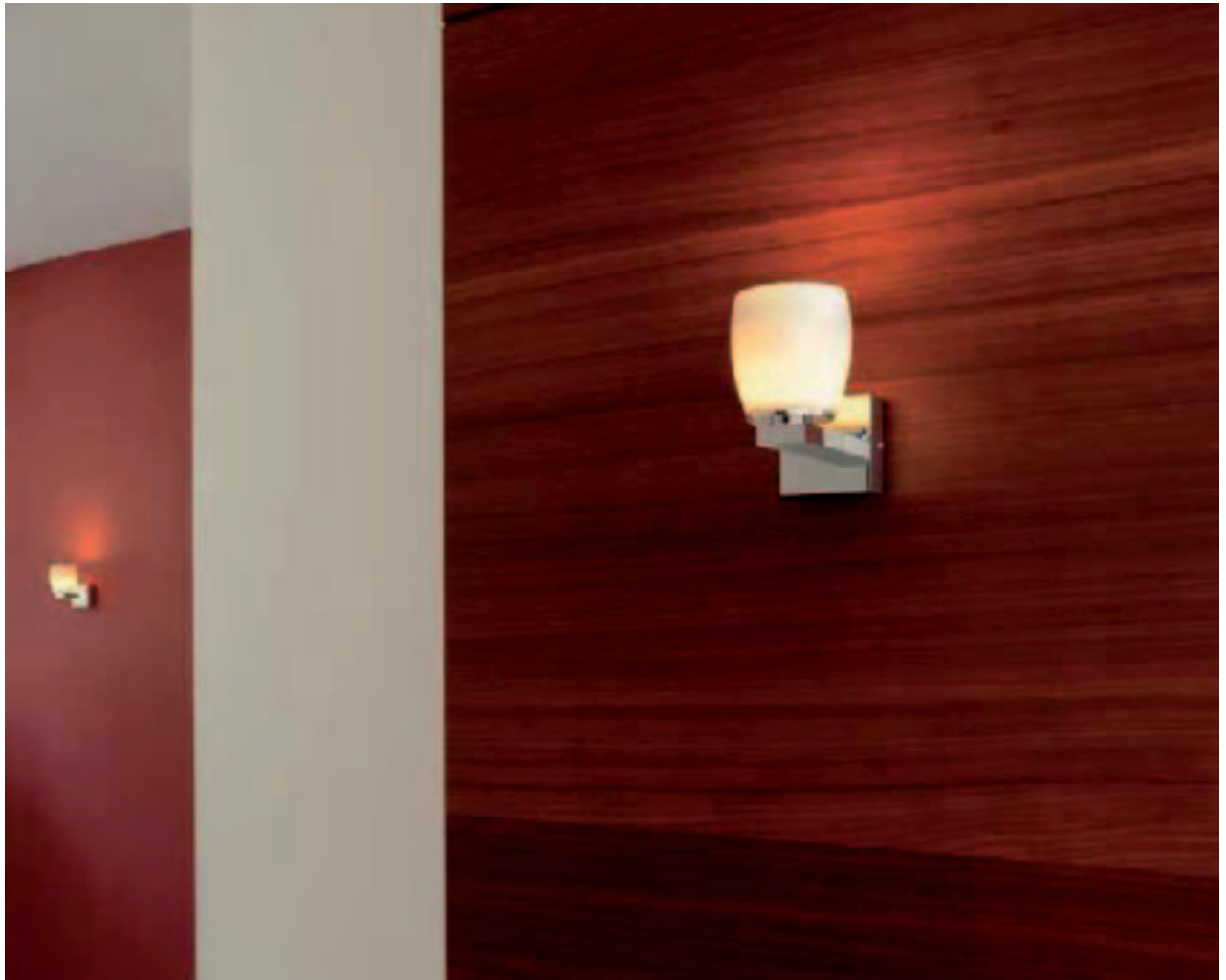

BIG SURA WALL

230~



Series: Page 091



Socket/Bulb:
G9/G9 (excl.)
60W max.

Material:
Aluminium/ceramic

Dimensions:
Head-Ø/H: 9/9,5 cm
Canopy-W/H/D: 8/8/2,9 cm
Wall distance: 14 cm

Versions:
chrome/white

Art. No.:
157242

Recommended bulb:
33W EnergySaver ≙ 40W
2700K, 460lm, EEK=C
519451



KOKO 2

230~

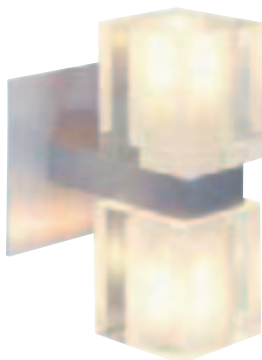

Socket/Bulb:
G9/G9 (excl.)
2x 40W max.

Material:
Aluminium/glass

Dimensions:
W/H/D: 8/13,5/11 cm

Versions:
Glass partial satined
alu brushed

Art. No.:
147479

Recommended bulb:
33W EnergySaver ≙ 40W
2700K, 460lm, EEK=C
519451





LALU® WALL 1/2 Design by CDC

230~

IP20/
IP43

Socket/Bulb:
E27/EnergySaver (excl.)
up to max. Ø/L: 4,5/17 cm
15W max.

Material:
Aluminium/acrylic

Dimensions:
W/H/D: 25/27,5/15 cm

Note:
The lamp achieves IP43 under the
condition that the lamp is mounted
with the bracket pointing
downwards.

Versions:
silver grey/white

Art. No.:
229512

Recommended bulb:
15W, 2700K, 800lm, EEK=A
508960



DARIUS

230~



Socket/Bulb:
E14/AGL candle shape (excl.)
2x 40W max.
or
E14/EnergySaver (excl.)
up to max. Ø/L: 5/16,5 cm

Material:
Steel/glass

Dimensions:
W/H/D: 30/32/10 cm

Versions:
Glass satined
silver grey

Art. No.:
151635

Recommended bulb:
11W, 2700K, 530lm, EEK=A
508810





CREST 1

230~



Socket/Bulb:
R7s/R7s, 78 mm (excl.)
100W max.

Material:
Steel/glass

Dimensions:
W/H/D: 20/30/10 cm

Versions:
Glass satined
silver grey

Art. No.:
151695

Recommended bulb:
100W EnergySaver \approx 150W
2700K, 1900lm, EEK=C
519215



CREST 2

230~



Socket/Bulb:
R7s/R7s, 78 mm (excl.)
100W max.

Material:
Steel/glass

Dimensions:
W/H/D: 20/30/10 cm

Versions:
Glass satined
silver grey

Art. No.:
151691

Recommended bulb:
100W EnergySaver \approx 150W
2700K, 1900lm, EEK=C
519215





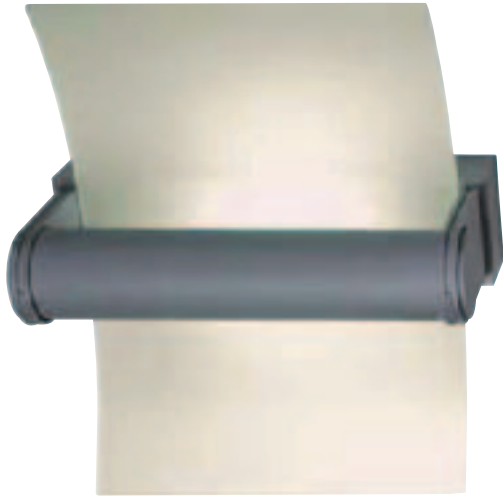

ZENIT

230~



Socket/Bulb:
G24d-2/TC-D EnergySaver (excl.)
18W

Versions:
Glass satined
silver grey

Art. No.:
151932

Material:
Aluminium/glass

Dimensions:
W/H/D: 29,5/25/14 cm

Recommended bulb:
18W, 2700K, 1200lm, EEK=B
508218



Accessory/Included parts:
Low-loss ballast (incl.)

CYLOVA

230~



Socket/Bulb:
R7s/R7s, 78 mm (excl.)
2x 100W max.

Versions:
Glass satined
silver grey

Art. No.:
151624

Material:
Steel/glass

Dimensions:
W/H/D: 24,5/46/8,5 cm

Recommended bulb:
100W EnergySaver Æ 150W
2700K, 1900lm, EEK=C
519215





KARDAMOD SURFACE

CEILING LUMINAIRES





KARDAMOD SURFACE SQUARE QRB Single Design by CDC

230~
12~

Socket/Bulb:
G53/QRB111 (excl.)
75W max.

Versions:
white
silver grey

Art. No.:
117121
117124

Material:
Steel

Dimensions:
L/W/H: 15,5/15,5/17,5 cm

Recommended bulb:
50W EnergySaver \approx 75W
545752 24°, 3000K, 5800cd
545753 40°, 3000K, 2000cd



Accessory/Included parts:
Electronic transformer (incl.)

KARDAMOD SURFACE SQUARE QRB Double Design by CDC

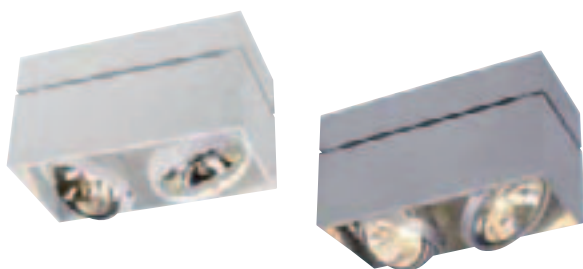
230~
12~

Socket/Bulb:
G53/QRB111 (excl.)
2x 75W max.

Versions:
white
silver grey

Art. No.:
117131
117134

Material:
Steel

Dimensions:
L/W/H: 31,5/15,5/17,5 cm

Recommended bulb:
50W EnergySaver \approx 75W
545752 24°, 3000K, 5800cd
545753 40°, 3000K, 2000cd



Accessory/Included parts:
Electronic transformer (incl.)

KARDAMOD SURFACE SQUARE ES111 Single Design by CDC

230~



Socket/Bulb:
GU10/ES111 (excl.)
75W max.

Versions:
white
silver grey

Art. No.:
117101
117104

Material:
Steel

Dimensions:
L/W/H: 15,5/15,5/15,5 cm

Recommended bulb:
75W, 24°, 2700K, 2000cd
575672



Recommended bulb:
PowerLED 10W, 25°, 460lm
550342 warm white



KARDAMOD SURFACE SQUARE ES111 Double Design by CDC

230~



Socket/Bulb:
GU10/ES111 (excl.)
2x 75W max.

Versions:
white
silver grey

Art. No.:
117111
117114

Material:
Steel

Dimensions:
L/W/H: 31,5/15,5/15,5 cm

Recommended bulb:
75W, 24°, 2700K, 2000cd
575672



Recommended bulb:
PowerLED 10W, 25°, 460lm
550342 warm white



KARDAMOD SURFACE ROUND QRB Single Design by CDC
230~
12~

Socket/Bulb:
G53/QRB111 (excl.)
75W max.

Material:
Steel

Dimensions:
Ø/H: 16/18 cm

Accessory/Included parts:
Electronic transformer (incl.)

Versions:
white
silver grey

Art. No.:
117171
117174

Recommended bulb:
50W EnergySaver \approx 75W
545752 24°, 3000K, 5800cd
545753 40°, 3000K, 2000cd

KARDAMOD SURFACE ROUND QRB Double Design by CDC
230~
12~

Socket/Bulb:
G53/QRB111 (excl.)
2x 75W max.

Material:
Steel

Dimensions:
W/H/D: 31/18/16 cm

Accessory/Included parts:
Electronic transformer (incl.)

Versions:
white
silver grey

Art. No.:
117191
117194

Recommended bulb:
50W EnergySaver \approx 75W
545752 24°, 3000K, 5800cd
545753 40°, 3000K, 2000cd

KARDAMOD SURFACE ROUND ES111 Single Design by CDC

230~



Socket/Bulb:
GU10/ES111 (excl.)
75W max.

Material:
Steel

Dimensions:
Ø/H: 16/18 cm

Versions:
white
silver grey

Art. No.:
117161
117164

Recommended bulb:
75W, 24°, 2700K, 2000cd
575672



Recommended bulb:
PowerLED 10W, 25°, 460lm
550342 warm white

KARDAMOD SURFACE ROUND ES111 Double Design by CDC

230~



Socket/Bulb:
GU10/ES111 (excl.)
2x 75W max.

Material:
Steel

Dimensions:
W/H/D: 31/18/16 cm

Versions:
white
silver grey

Art. No.:
117181
117184

Recommended bulb:
75W, 24°, 2700K, 2000cd
575672



Recommended bulb:
PowerLED 10W, 25°, 460lm
550342 warm white







ACRYLIC BOX

CEILING LUMINAIRES



ACRYLIC BOX GU10 Single/Double

Material:
PMMA

Recommended bulb:
35W EnergySaver \approx 50W
20°, 2800K, 1200cd
575370



Recommended bulb:
PHILIPS PowerLED 6W
40°, 3000K, 600cd, 320lm
560104



ACRYLIC BOX GU10 Single/Double

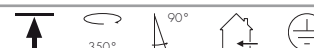

Article No.	Description	Colour	Voltage in AC	Socket/ Bulb (excl.)	Wattage Bulb	Length in cm	Width in cm	Height in cm	Weight in kg	Price
117221	Acrylic Box Single GU10	black/translucent	230V	GU10/GU10	50W max.	12,6	12,6	15,2	0,6	
117222	Acrylic Box Double GU10	black/translucent	230V	GU10/GU10	2x 50W max.	24,5	12,6	15,2	0,97	

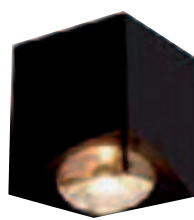

ACRYLIC BOX QR B111 Single/Double



Material:
PMMA

Recommended bulb:
50W EnergySaver \approx 75W
545752 24°, 3000K, 5800cd
545753 40°, 3000K, 2000cd



Accessory/Included parts:
Electronic transformer (incl.)

ACRYLIC BOX ES 111 Single/Double

Material:
PMMA

Recommended bulb:
75W, 24°, 2700K, 2000cd
575672



Recommended bulb:
PowerLED 10W, 25°, 460lm
550342 warm white



ACRYLIC BOX QR B111/ES 111 Single/Double

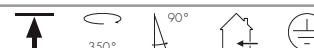

Article No.	Description	Colour	Voltage in AC	Socket/ Bulb (excl.)	Wattage Bulb	Length in cm	Width in cm	Height in cm	Weight in kg	Price
117211	Acrylic Box Single QR B111	black/translucent	230V/12V	G53/QR B111	75W max.	15,0	15,0	17,0	0,82	
117212	Acrylic Box Double QR B111	black/translucent	230V/12V	G53/QR B111	2x 50W max.	29,4	15,0	17,0	1,22	
117231	Acrylic Box Single ES 111	black/translucent	230V	GU10/ES 111	75W max.	15,0	15,0	17,8	0,84	
117232	Acrylic Box Double ES 111	black/translucent	230V	GU10/ES 111	2x 75W max.	29,4	15,0	17,8	1,43	



JESSY

WALL AND CEILING LUMINAIRES

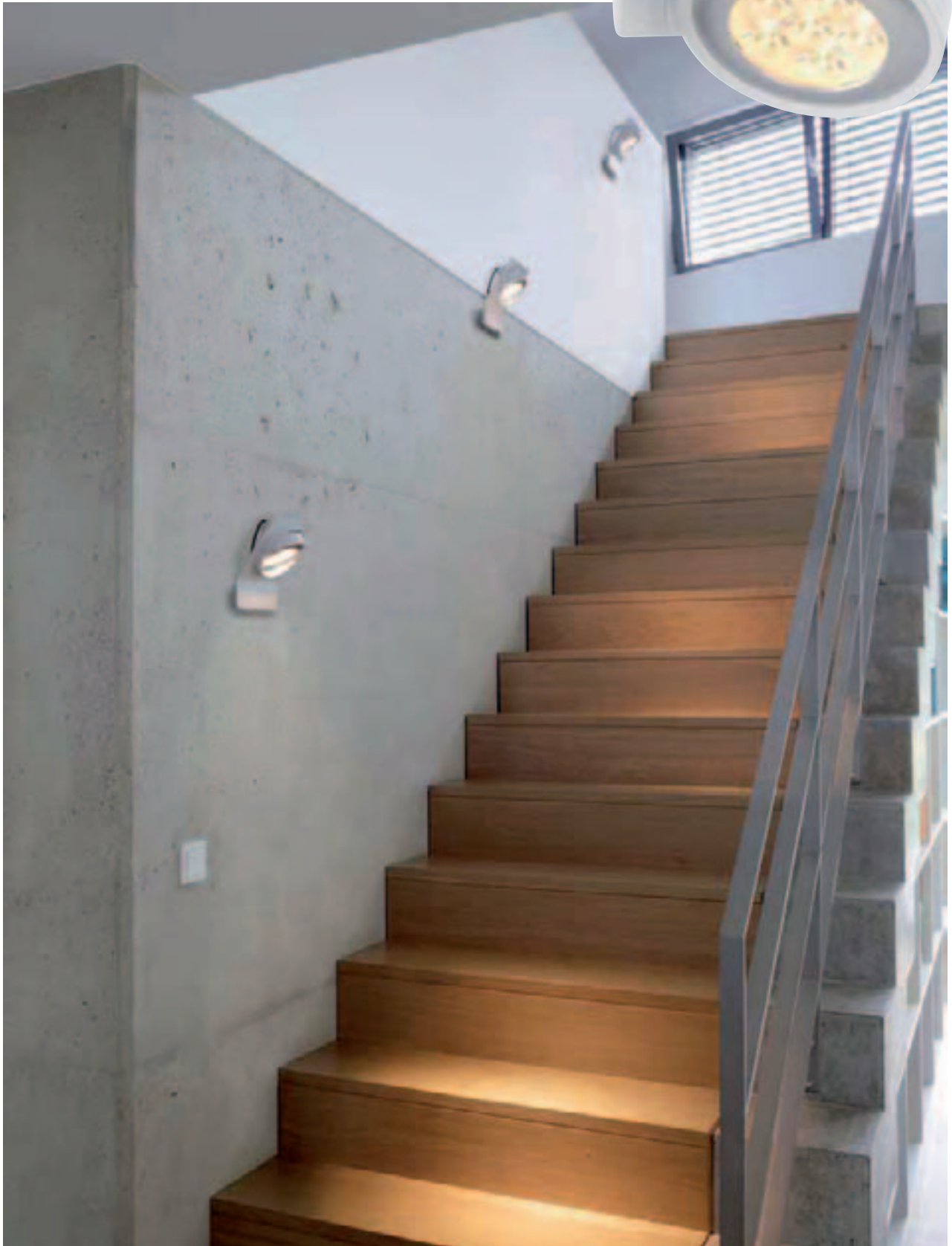



JESSY CL-1 ES111

white 147041

Material: Aluminium/steel

Recommended bulb:
75W, 24°, 2700K, 2000cd
575672



JESSY WL-2 ES111

white 147011

Material: Aluminium/steel
Dimensions: Canopy-W/H/D: 12/4,5/2 cm

Recommended bulb:
75W, 24°, 2700K, 2000cd
575672



Recommended bulb:
PowerLED 10W, 25°, 460lm
550342 warm white



JESSY WL-1 QRB

white 147001

Material: Aluminium/steel
Dimensions: Canopy-W/H/D:
10,5/10,5/3,5 cm
Included parts: Electronic transformer (incl.)

Recommended bulb:
50W EnergySaver ± 75W
545752 24°, 3000K, 5800cd
545753 40°, 3000K, 2000cd



JESSY ES111/QRB111

Article No.	Description	Colour	Voltage in AC	Socket/ Bulb (excl.)	Wattage Bulb	Width in cm	Height in cm	Depth in cm	Rotation/ swivel range	Operating range	Weight in kg	Price
147041	Jessy CL-1 ES111	white	230V	GU10/ES111	75W max.	13,0	12,5	14,5	340°/180°	Ceiling	0,61	
147011	Jessy WL-2 ES111	white	230V	GU10/ES111	75W max.	15,2	21,0	14,0	350°/90°	Wall, Ceiling	0,60	
147001	Jessy WL-1 QRB	white	230V/12V	G53/QRB111	75W max.	15,3	28,5	13,0	350°/60°	Wall, Ceiling	0,86	



JESSY WL-3 G9

white 147021

Material: Aluminium/steel

Recommended bulb:
33W EnergySaver ± 40W
2700K, 460lm, EEK=C
519451

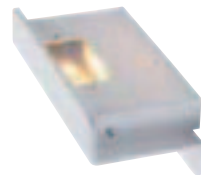

JESSY WL-4 LED

white 147031

Material: Aluminium/steel
Included parts: LED converter (incl.)



JESSY G9/LED

Article No.	Description	Colour	Voltage	Socket/ Bulb (excl.)	Colour temperature	Luminous flux	Wattage Bulb	Width in cm	Height in cm	Depth in cm	Operating range	Weight in kg	Price
147021	Jessy WL-3 G9	white	230V AC	G9/G9 (excl.)	-	-	42W max.	17	6	8	Wall	0,45	
147031	Jessy WL-4 LED	white	230V AC/350mA	PlanarLED (incl.)	3000K	270lm	4W total	17	6	8	Wall	0,48	

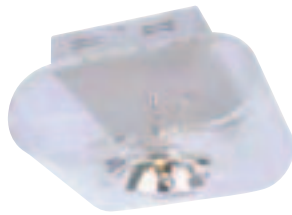

clear | 147581 |
black | 147591 |



clear | 147582 |
black | 147592 |

RETROSIX QRB 1/2



Material:
Steel/acrylic

Accessory/Included parts:
Electronic transformer (incl.)

Recommended bulb:
PowerLED 12W
24°, 2700K, 3600cd, 500lm
570001



Recommended bulb:
50W, 45°, 2700K, 700cd
543545



Article No.	Description	Colour	Voltage in AC	Socket/ Bulb (excl.)	Wattage Bulb	Length in cm	Width in cm	Height in cm	Weight in kg	Price
147581	Retrosix QRB 1	alu brushed/clear	230V/12V	G53/QRB111	50W max.	23,5	17,5	12,5	1,05	
147591	Retrosix QRB 1	alu brushed/black	230V/12V	G53/QRB111	50W max.	23,5	17,5	12,5	1,05	
147582	Retrosix QRB 2	alu brushed/clear	230V/12V	G53/QRB111	2x 50W max.	40	17,5	12,8	2,04	
147592	Retrosix QRB 2	alu brushed/black	230V/12V	G53/QRB111	2x 50W max.	40	17,5	12,8	2,04	

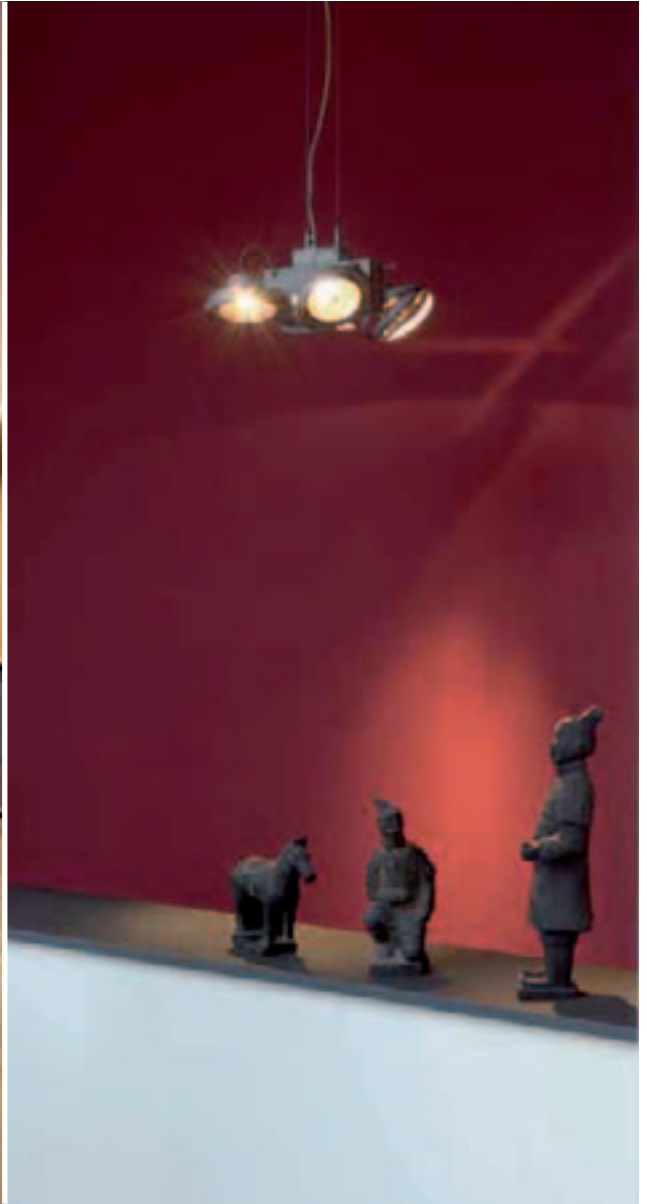

TEC KARDA 2/4/6



Material:
Aluminium

Accessory/Included parts:
Electronic transformer (incl.)
Suspension set (excl.)

Note:
Pendant operation is possible with optional suspension set (149150).

Recommended accessory:
Suspension set, weight: 0,5 kg
Rope suspension-L/cable-L: 2,5 m
Cable 3x 0,75 mm²
149150



Recommended bulb:
35W EnergySaver \approx 50W
24°, 3000K, 4500cd
545522



Article No.	Description	Colour	Voltage in AC	Socket/ Bulb (excl.)	Wattage Bulb	Length in cm	Width in cm	Height in cm	Weight in kg	Price
149142	Tec Karda 2	silver grey	230V/12V	G53/QRB111	2x 50W max.	14,0	32,0	17,5	0,85	
149144	Tec Karda 4	silver grey	230V/12V	G53/QRB111	4x 50W max.	30,5	32,0	17,5	1,55	
149146	Tec Karda 6	silver grey	230V/12V	G53/QRB111	6x 50W max.	49,0	32,0	17,5	2,30	



Series: Page 060, 061, 080

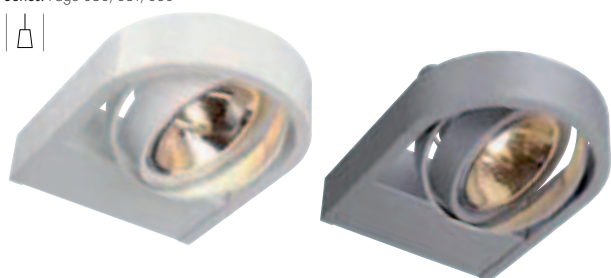

AIXLIGHT® R WALL QRB111 Design by CDC



Socket/Bulb:
G53/QRB111 (excl.)
50W max.

Material:
Aluminium

Dimensions:
L/W/H: 24,5/18/5 cm

Accessory/Included parts:
Electronic transformer (incl.)

Versions:	Art. No.:
black	159000
white	159001
silver grey	159004

Recommended bulb:
35W EnergySaver ± 50W
24°, 3000K, 4500cd
545522



Recommended bulb:
PowerLED 12W
24°, 2700K, 3600cd, 500lm
570001



Series: Page 060, 061, 081



AIXLIGHT® R2 WALL QRB111 Design by CDC



Socket/Bulb:
G53/QRB111 (excl.)
50W max.

Material:
Aluminium

Dimensions:
L/W/H: 24,5/18/5 cm

Accessory/Included parts:
Electronic transformer (incl.)

Versions:	Art. No.:
black	159010
white	159011
silver grey	159014

Recommended bulb:
35W EnergySaver ± 50W
24°, 3000K, 4500cd
545522



Recommended bulb:
PowerLED 12W
24°, 2700K, 3600cd, 500lm
570001





Series: Page 076

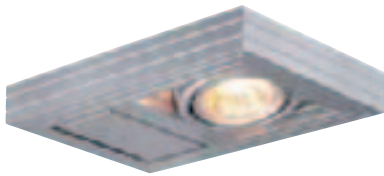

AIXLIGHT® KARDAFRAME WALL GU10 Design by CDC



Socket/Bulb:
GU10/GU10 (excl.)
50W max.

Versions:
silver grey

Art. No.:
154292

Material:
Aluminium

Dimensions:
L/W/H: 20,8/13/7,5 cm

Recommended bulb:
35W EnergySaver ± 50W
20°, 2800K, 1200cd
575370



Recommended bulb:
COB LED 5,6W
60°, 5000K-5300K, 320lm
551332



Series: Page 078

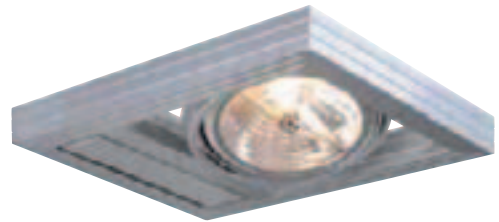

AIXLIGHT® KARDAFRAME WALL QRB111 Design by CDC



Socket/Bulb:
G53/QRB111 (excl.)
50W max.

Accessory/Included parts:
Electronic transformer (incl.)

Versions:
silver grey

Art. No.:
154262

Dimensions:
L/W/H: 25,5/19/3 cm

Recommended bulb:
50W EnergySaver ± 75W
24°, 3000K, 5800cd
545752





KALU

WALL AND CEILING LUMINAIRES



KALU 1 Design by CDC

Series: Page 047, 402



Socket/Bulb:
G53/QRB111 (excl.)
50W max.

Material:
Aluminium

Dimensions:
L/W/H: 15/9/19 cm

Accessory/Included parts:
Electronic transformer (incl.)

Versions:
white
alu brushed

Art. No.:
147251
147256

Recommended bulb:
50W EnergySaver \approx 75W
24°, 3000K, 5800cd
545752



Recommended bulb:
PowerLED 12W
24°, 3000K, 4000cd, 550lm
570003



KALU 2 Design by CDC

Series: Page 047, 402



Socket/Bulb:
G53/QRB111 (excl.)
2x 50W max.

Material:
Aluminium

Dimensions:
L/W/H: 30/9/19 cm

Accessory/Included parts:
Electronic transformer (incl.)

Versions:
white
alu brushed

Art. No.:
147261
147266

Recommended bulb:
50W EnergySaver \approx 75W
24°, 3000K, 5800cd
545752



Recommended bulb:
PowerLED 12W
24°, 3000K, 4000cd, 550lm
570003



KALU 3 Design by CDC

Series: Page 047, 402



Socket/Bulb:
G53/QRB111 (excl.)
3x 50W max.

Material:
Aluminium

Dimensions:
L/W/H: 45/9/19 cm

Accessory/Included parts:
Electronic transformer (incl.)

Versions:
white
alu brushed

Art. No.:
147271
147276

Recommended bulb:
50W EnergySaver \approx 75W
24°, 3000K, 5800cd
545752



Recommended bulb:
PowerLED 12W
24°, 3000K, 4000cd, 550lm
570003







KALU 2 ES111

230~

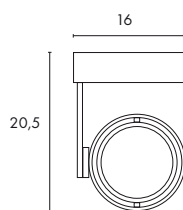

Socket/Bulb:
GU10/ES111 (excl.)
50W max.
or
DomeLED ES111, 9W (excl.)

Material:
Aluminium

Dimensions:
W/H/D: 16/20,5/16 cm

Versions:
alu brushed

Art. No.:
147706

Recommended bulb:
50W, 24°, 2700K, 1300cd
575652



Recommended bulb:
DomeLED 9W, 60°, 176lm
550392 warm white



KALU 2 ES111 DOUBLE

230~

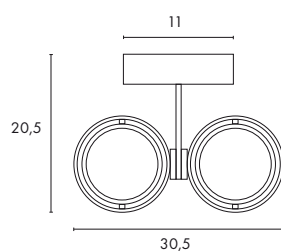

Socket/Bulb:
GU10/ES111 (excl.)
2x 50W max.
or
DomeLED ES111, 2x 9W (excl.)

Material:
Aluminium

Dimensions:
W/H/D: 30,5/20,5/16 cm

Versions:
alu brushed

Art. No.:
147716

Recommended bulb:
50W, 24°, 2700K, 1300cd
575652



Recommended bulb:
DomeLED 9W, 60°, 176lm
550392 warm white





KALU 2 LED

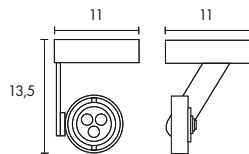

Bulb:
PowerLED (incl.)
3x 1W

Versions:
alu brushed
LED warm white

Art. No.:
147762

Material:
Aluminium

Dimensions:
W/H/D: 11/13,5/11 cm

Accessory/Included parts:
LED converter (incl.)

KALU 2 LED DOUBLE

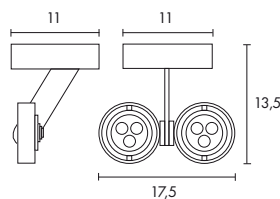

Bulb:
PowerLED (incl.)
6x 1W

Versions:
alu brushed
LED warm white

Art. No.:
147772

Material:
Aluminium

Dimensions:
W/H/D: 17,5/13,5/11 cm

Accessory/Included parts:
LED converter (incl.)



ASTO

WALL UND CEILING LUMINAIRES



white | 147411 |
alu brushed | 147421 |

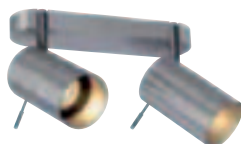

white | 147412 |
alu brushed | 147422 |

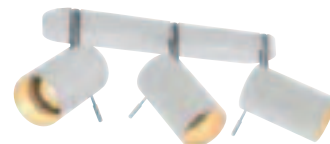

white | 147413 |
alu brushed | 147423 |

ASTO TUBE 1/2/3 Design by CDC



Bulb:
GU10 (excl.)
or PAR20 (excl.)
up to max. Ø/L: 6,4/8,1 cm

Material:
Aluminium

Recommended bulb:
PAR20 75W
50°, 2700K, 1060cd
575682



Recommended bulb:
 PowerLED 4W
25°, 3000K, 700cd, 180lm
560013



Article No.	Description	Colour	Voltage in AC	Socket	Wattage Bulb	Head-Ø/H in cm	Canopy-Ø/H in cm	Canopy-L/W/H in cm	Weight in kg	Price
147411	Asto Tube 1	white	230V	GU10	75W max.	7/12	7/2,5	-	0,34	
147421	Asto Tube 1	alu brushed	230V	GU10	75W max.	7/12	7/2,5	-	0,34	
147412	Asto Tube 2	white	230V	GU10	2x 75W max.	7/12	-	25/7/2,5	0,75	
147422	Asto Tube 2	alu brushed	230V	GU10	2x 75W max.	7/12	-	25/7/2,5	0,75	
147413	Asto Tube 3	white	230V	GU10	3x 75W max.	7/12	-	36/7/2,5	1,15	
147423	Asto Tube 3	alu brushed	230V	GU10	3x 75W max.	7/12	-	36/7/2,5	1,15	



ASTO 1/2/3/4



Bulb:
GU10 (excl.)
or PAR20 (excl.)
or ES111 (excl.)

Material:
Aluminium

Accessory/Included parts:
Deco rings for GU10 (incl.)

Recommended bulb:
35W EnergySaver ≠ 50W
20°, 2800K, 1200cd
575370



Recommended bulb:
75W, 24°, 2700K, 2000cd
575672



Recommended bulb:
 PowerLED 4W
25°, 3000K, 700cd, 180lm
560013



Recommended bulb:
DomeLED 9W, 60°, 176lm
550392 warm white



Article No.	Description	Colour	Voltage in AC	Socket	Wattage Bulb	Length in cm	Width in cm	Height in cm	Weight in kg	Price
147441	Asto 1	alu brushed	230V	GU10	75W max.	12,0	6,5	10,0	0,25	
147442	Asto 2	alu brushed	230V	GU10	2x 75W max.	26,0	6,5	10,0	0,35	
147443	Asto 3	alu brushed	230V	GU10	3x 75W max.	45,5	6,5	10,0	0,55	
147444	Asto 4	alu brushed	230V	GU10	4x 75W max.	63,0	6,5	10,0	0,80	



INDA SPOT GU10



Socket/Bulb:
GU10/GU10 (excl.)
50W max.

Version:
white matt
alu brushed

Art. No.:
147551
147559

Material:
Aluminium

Dimensions:
Ø/H: 6/15,8 cm
Canopy-Ø/H: 6/2,8 cm

Recommended bulb:
35W EnergySaver ± 50W
20°, 2800K, 1200cd
575370



Recommended bulb:
PHILIPS PowerLED 4W
25°, 3000K, 700cd, 180lm
560013





HURIT SINGLE Design by CDC



Socket/Bulb:
GU10/GU10; ES111 (excl.)
75W max.

Version:
alu brushed/chrome

Art. No.:
157304

Material:
Aluminium

Dimensions:
W/H/D: 11/11/13,5 cm
Canopy-L/W/H: 11/11/2,5 cm

Recommended bulb:
75W, 24°, 2700K, 2000cd
575672



HURIT TWIN Design by CDC

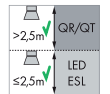

Socket/Bulb:
GU10/GU10; ES111 (excl.)
2x 75W max.

Version:
alu brushed/chrome

Art. No.:
157314

Material:
Aluminium

Dimensions:
W/H/D: 11/11/30 cm
Canopy-L/W/H: 11/11/2,5 cm

Recommended bulb:
75W, 24°, 2700K, 2000cd
575672



N-TIC SPOT 230V Design by CDC



Socket/Bulb:
GU10/GU10 (excl.)
50W max.

Version:
chrome matt

Art. No.:
131108

Material:
Steel

Dimensions:
L/W/H: 8/9/16,5 cm
Canopy-Ø/H: 6/2,5 cm

Recommended bulb:
35W EnergySaver ≈ 50W
20°, 2800K, 1200cd
575370



Recommended bulb:
COB LED 5,6W
60°, 5000K-5300K, 320lm
551332



SPOT 79 230V

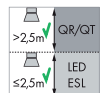

Socket/Bulb:
GU10/GU10 (excl.)
50W max.

Version:
black
white
silver grey

Art. No.:
132020
132021
132024

Material:
Aluminium

Dimensions:
W/H: 9,5/15 cm
Canopy-Ø/H: 8,5/2,5 cm

Recommended bulb:
35W EnergySaver ≈ 50W
20°, 2800K, 1200cd
575370



Recommended bulb:
COB LED 5,6W
60°, 5000K-5300K, 320lm
551332







TIGLA SQUARE

230~



Socket/Bulb:
GU10/GU10 (excl.)
50W max.

Versions:
Acrylic satined
alu brushed

Art. No.:
114740

Material:
Aluminium/acrylic

Dimensions:
L/W/H: 8/8/11 cm

Recommended bulb:
35W EnergySaver \approx 50W
20°, 2800K, 1200cd
575370



Recommended bulb:
PowerLED 4W
40°, 3000K, 350cd, 180lm
560014



TIGLA ROUND

230~



Socket/Bulb:
GU10/GU10 (excl.)
50W max.

Versions:
Acrylic satined
alu brushed

Art. No.:
114730

Material:
Aluminium/acrylic

Dimensions:
 \varnothing /H: 8,7/11,7 cm

Recommended bulb:
35W EnergySaver \approx 50W
20°, 2800K, 1200cd
575370



Recommended bulb:
PowerLED 4W
40°, 3000K, 350cd, 180lm
560014



ASTINA UP-DOWN

230~



Socket/Bulb:
GU10/GU10 (excl.)
2x 50W max.

Versions:
Glass satined
silver grey

Art. No.:
151901

Material:
Aluminium/glass

Dimensions:
W/H/D: 7/20/12,5 cm

Recommended bulb:
35W EnergySaver \approx 50W
20°, 2800K, 1200cd
575370



Recommended bulb:
PowerLED 4W
40°, 3000K, 350cd, 180lm
560014



LIMA UP-DOWN Design by CDC

230~



Series: Page 282



Socket/Bulb:
GU10/GU10 (excl.)
2x 50W max.

Versions:
chrome
silver grey

Art. No.:
157222
157224

Material:
Aluminium/glass

Dimensions:
W/H/D: 7/20,5/10 cm
Canopy-W/H/D: 5,5/20,5/2,5 cm

Note:
Grid insert is removable.

Recommended bulb:
35W EnergySaver \approx 50W
20°, 2800K, 1200cd
575370





ENNA Design by FGL

230~



Series: Page 091

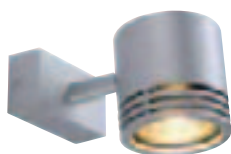

Socket/Bulb:
GU10/GU10 (excl.)
50W max.

Material:
Aluminium

Dimensions:
W/H/D: 8/7/13 cm
Head-Ø: 7 cm

Versions:
silver grey

Art. No.:
151912

Recommended bulb:
35W EnergySaver \approx 50W
20°, 2800K, 1200cd
575370



Recommended bulb:
PHILIPS PowerLED 4W
40°, 3000K, 350cd, 180lm
560014



DIO Design by FGL

230~



Series: Page 091

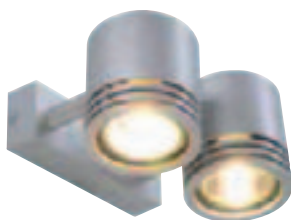

Socket/Bulb:
GU10/GU10 (excl.)
2x 50W max.

Material:
Aluminium

Dimensions:
W/H/D: 15,5/7/13 cm
Head-Ø: 7 cm

Versions:
silver grey

Art. No.:
151922

Recommended bulb:
35W EnergySaver \approx 50W
20°, 2800K, 1200cd
575370



Recommended bulb:
PHILIPS PowerLED 4W
40°, 3000K, 350cd, 180lm
560014



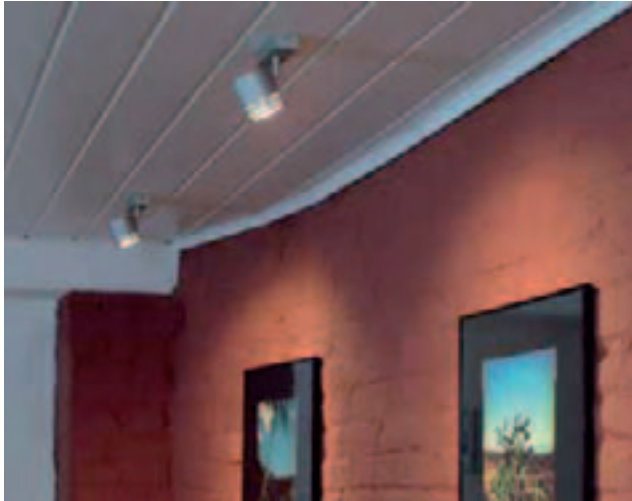

BARRO WL-1 Design by FGL

230~

Series: Page 091

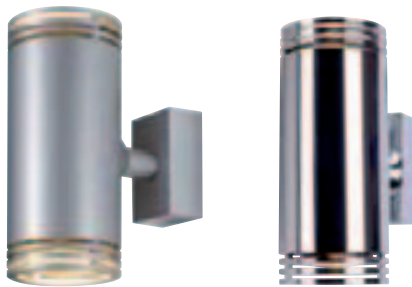

Socket/Bulb:
GU10/GU10 (excl.)
2x 50W max.

Versions:
silver grey

Art. No.:
151910

Material:
Aluminium

chrome

151914

Dimensions:
W/H/D: 7/17/12 cm

Recommended bulb:
35W EnergySaver ≈ 50W
20°, 2800K, 1200cd
575370



Recommended bulb:
 PowerLED 4W
40°, 3000K, 350cd, 180lm
560014



BARRO CL-1 Design by FGL

230~

Series: Page 091



Socket/Bulb:
GU10/GU10 (excl.)
50W max.

Versions:
silver grey

Art. No.:
116202

Material:
Aluminium

chrome

116204

Dimensions:
Ø/H: 7/8 cm

Recommended bulb:
35W EnergySaver ≈ 50W
20°, 2800K, 1200cd
575370



Recommended bulb:
 PowerLED 4W
40°, 3000K, 350cd, 180lm
560014



E27 TUBE Design by CDC

230~



Socket/Bulb:
E27/AGL (excl.)
75W max.
or
E27/EnergySaver (excl.)

Note:
Not suitable for halogen bulbs.

Versions:
chrome

Art. No.:
111472

Material:
Steel

Dimensions:
Ø/H: 6/9,5 cm
Canopy-Ø: 10 cm

Recommended bulb:
10W, 3000K, 700lm, EEK=A
551342



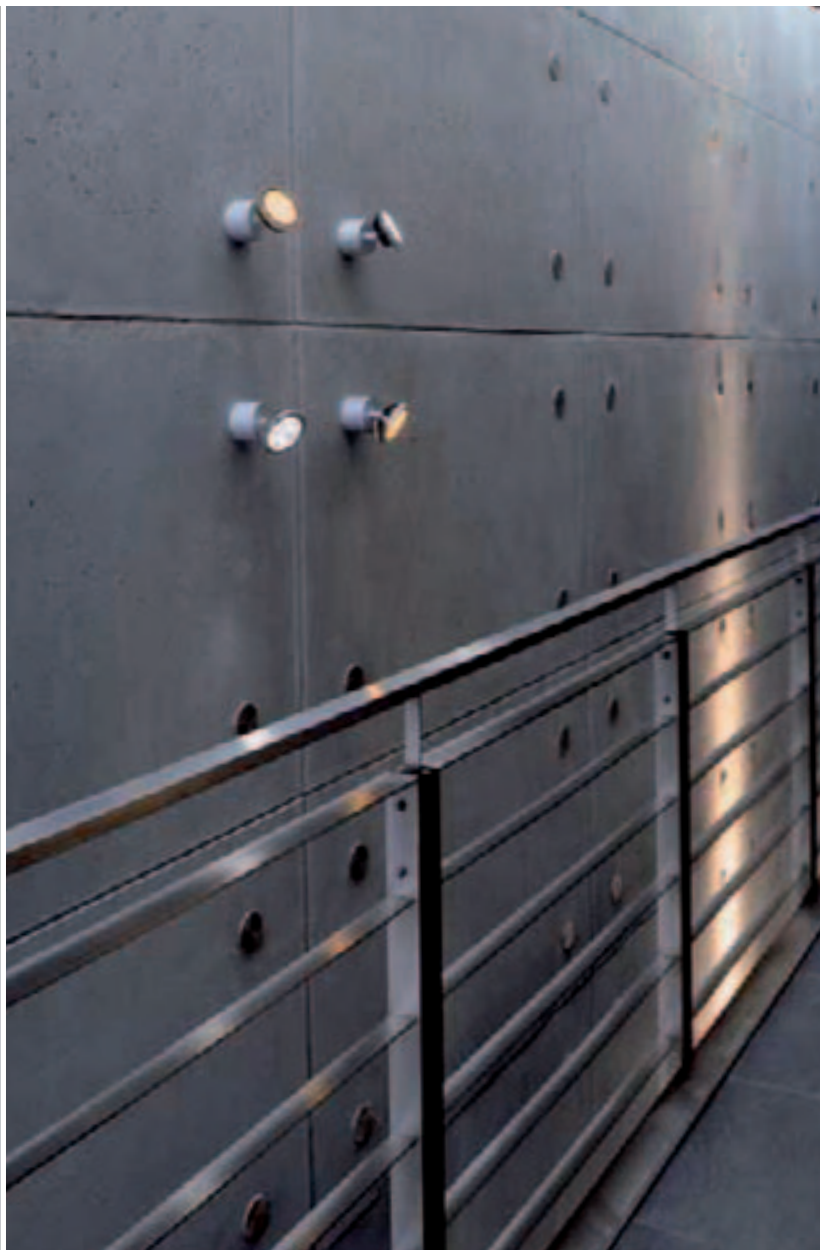

DomeLED CEILING

LED
LEDTEC

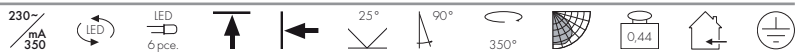

Bulb:
PowerLED (incl.)
Øx 1W

Dimensions:
Ø/H: 9,8/11,6 cm
Canopy-Ø/H: 8/5,6 cm

Versions:
silver grey
LED white
LED warm white

Art. No.:
147331
147332

Material:
Aluminium

Accessory/Included parts:
LED converter (incl.)

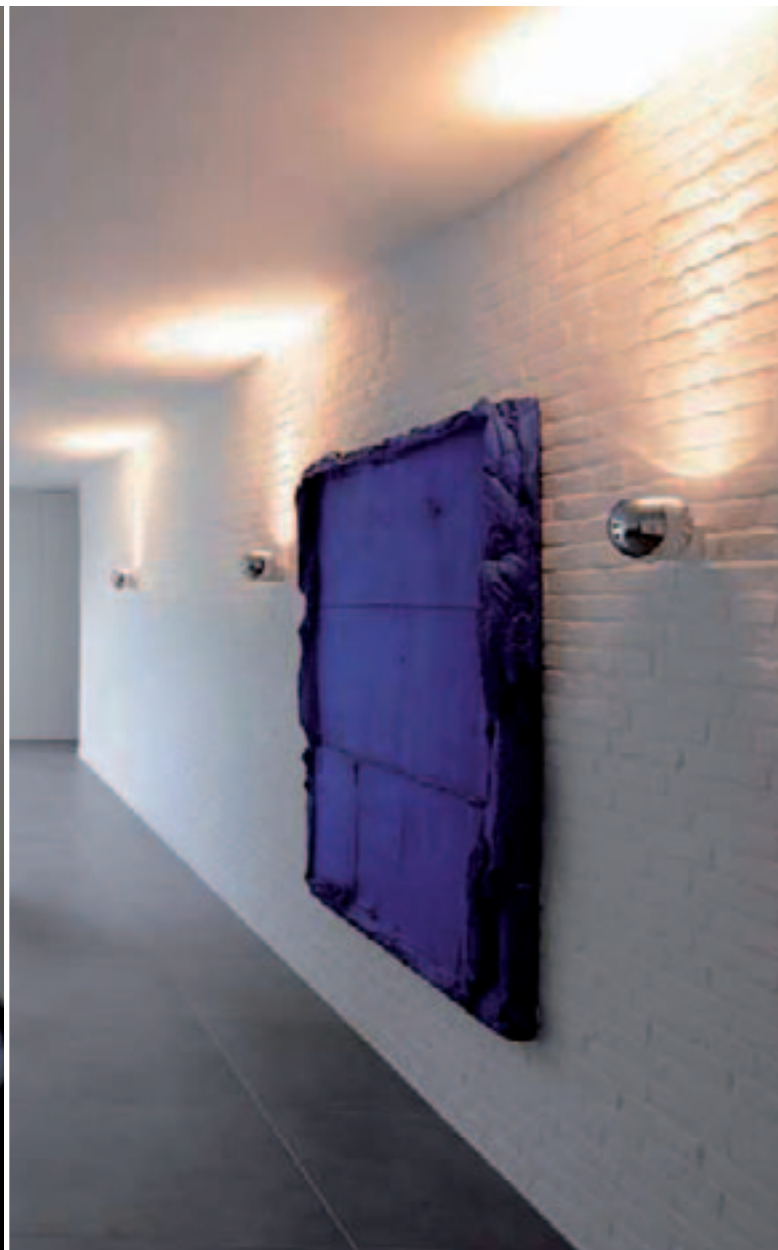

Series: Page 047, 084, 252, 253, 276



LIGHT EYE Design by CDC



Socket/Bulb:
GU10/ES111 (excl.)
75W max.

Material:
Aluminium/steel

Dimensions:
W/H: 15,5/20 cm
Head-Ø: 14,5 cm
Canopy-Ø/H: 8/3 cm

Accessory/Included parts:
Canopy (incl.)

Versions:
chrome

Art. No.:
149042

Recommended bulb:
75W, 24°, 2700K, 2000cd
575672



Recommended bulb:
DomeLED 9W, 60°, 176lm
550392 warm white



LIGHT EYE BALL



Socket/Bulb:
GU10/ES111 (excl.)
75W max.

Material:
Steel

Dimensions:
Ø/H/D: 15/13/17,5 cm
Head-Ø/H: 14,5/13 cm
Canopy-W/H/D: 3,5/7/3 cm

Versions:
chrome/white

Art. No.:
149031

Recommended bulb:
75W, 24°, 2700K, 2000cd
575672



Recommended bulb:
DomeLED 9W, 60°, 176lm
550392 warm white





ROX

WALL AND CEILING LUMINAIRE SERIES



ROX UP-DOWN

230~



Socket/Bulb:
GU10/ES111 (excl.)
2x 50W max.

Material:
Aluminium

Dimensions:
Ø/H/D: 12,5/20,5/13 cm

Versions:
alu natural

Art. No.:
149336

Recommended bulb:
50W, 24°, 2700K, 1300cd
575652



ROX WALL

230~



Socket/Bulb:
GU10/ES111 (excl.)
75W max.

Material:
Aluminium

Dimensions:
Ø/H/D: 12,5/16,1/13 cm

Versions:
alu natural

Art. No.:
149326

Recommended bulb:
75W, 24°, 2700K, 2000cd
575672



ROX CEILING

230~



Socket/Bulb:
GU10/ES111 (excl.)
75W max.

Material:
Aluminium

Dimensions:
Ø/H: 12,5/12,5 cm

Versions:
alu natural

Art. No.:
149316

Recommended bulb:
75W, 24°, 2700K, 2000cd
575672









Design by CDC
THEO UP-DOWN

white 152081
silver grey 152082
alu brushed 152089

Material: Aluminium

Recommended bulb:
35W EnergySaver \approx 50W
20°, 2800K, 1200cd
575370



BIG THEO UP-DOWN

white 149291
silver grey 149294

Material: Aluminium

Recommended bulb:
75W, 24°, 2700K, 2000cd
575672

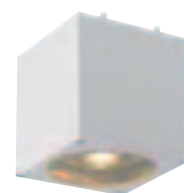

BIG THEO CEILING

white 149271
silver grey 149274

Material: Aluminium

Recommended bulb:
75W, 24°, 2700K, 2000cd
575672



THEO/BIG THEO GU10/ES111

230~  

Article No.	Description	Colour	Voltage in AV	Socket/Bulb (excl.)	Wattage Bulb	Width in cm	Height in cm	Depth in cm	Operating range	Beam	Weight in kg	Price
152081	Theo Up-Down	white	230V	GU10/GU10	2x 50W max.	70	22,5	70	Wall	Up-Down	0,70	
152082	Theo Up-Down	silver grey	230V	GU10/GU10	2x 50W max.	70	22,5	70	Wall	Up-Down	0,70	
152089	Theo Up-Down	alu brushed	230V	GU10/GU10	2x 50W max.	70	22,5	70	Wall	Up-Down	0,70	
149291	Big Theo Up-Down	white	230V	GU10/ES111	2x 75W max.	13,0	27,0	13,5	Wall	Up-Down	1,65	
149294	Big Theo Up-Down	silver grey	230V	GU10/ES111	2x 75W max.	13,0	27,0	13,5	Wall	Up-Down	1,65	
149271	Big Theo Ceiling	white	230V	GU10/ES111	75W max.	13,0	14,0	13,0	Ceiling	Down	0,95	
149274	Big Theo Ceiling	silver grey	230V	GU10/ES111	75W max.	13,0	14,0	13,0	Ceiling	Down	0,95	



ALTRA DICE

WALL AND CEILING LUMINAIRE SERIES

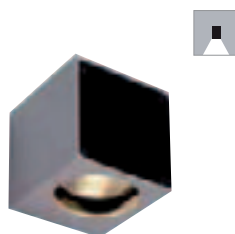

white | 151501 |
silver grey/black | 151504 |



white | 151561 |
silver grey/black | 151564 |

ALTRA DICE Wall luminaires

230~



Material:
Aluminium/steel

Recommended bulb:
35W EnergySaver \neq 50W
20°, 2800K, 1200cd
575370



Recommended bulb:
PHILIPS PowerLED 4W
40°, 3000K, 350cd, 180lm
560014



Article No.	Description	Colour	Voltage	Socket/ Bulb (excl.)	Wattage Bulb	Length in cm	Width in cm	Height in cm	Rotation/ Swivel range	Weight in kg	Price
151501	Altra Dice WL-1	white/white	230V AC	GU10/GU10	35W max.	7,0	7,0	8,0	-	0,30	
151504	Altra Dice WL-1	silver grey/black	230V AC	GU10/GU10	35W max.	7,0	7,0	8,0	-	0,30	
151561	Altra Dice WL-2	white/white	230V AC	GU10/GU10	50W max.	7,0	7,0	30,0	-	0,55	
151564	Altra Dice WL-2	silver grey/black	230V AC	GU10/GU10	50W max.	7,0	7,0	30,0	-	0,55	



white | 151511 |
silver grey/black | 151514 |



white | 151521 |
silver grey/black | 151524 |



white | 151531 |
silver grey/black | 151534 |



ALTRA DICE Ceiling luminaires

230~



Material:
Aluminium/steel

Recommended bulb:
35W EnergySaver \neq 50W
20°, 2800K, 1200cd
575370



Recommended bulb:
PHILIPS PowerLED 4W
40°, 3000K, 350cd, 180lm
560014



Article No.	Description	Colour	Voltage in AC	Socket/ Bulb (excl.)	Wattage Bulb	Length in cm	Width in cm	Height in cm	Rotation/ Swivel range	Weight in kg	Price
151511	Altra Dice CL-1	white/white	230V	GU10/GU10	35W max.	7,0	7,0	10,0	-	0,28	
151514	Altra Dice CL-1	silver grey/black	230V	GU10/GU10	35W max.	7,0	7,0	10,0	-	0,28	
151521	Altra Dice Spot 1	white/white	230V	GU10/GU10	50W max.	15,0	7,0	10,0	350°/180°	0,50	
151524	Altra Dice Spot 1	silver grey/black	230V	GU10/GU10	50W max.	15,0	7,0	10,0	350°/180°	0,50	
151531	Altra Dice Spot 2	white/white	230V	GU10/GU10	2x 50W max.	22,5	7,0	10,0	350°/180°	0,78	
151534	Altra Dice Spot 2	silver grey/black	230V	GU10/GU10	2x 50W max.	22,5	7,0	10,0	350°/180°	0,78	





SQUARE DICE

WALL AND CEILING LUMINAIRE SERIES



SQUARE WALL Design by FGL

230~



Socket/Bulb:
GU10/GU10 (excl.)
50W max.

Material:
Aluminium/glass

Dimensions:
W/H/D: 7/32,5/7 cm

Recommended bulb:
35W EnergySaver ± 50W
20°, 2800K, 1200cd
575370



Versions:
silver grey
Glass satined

Art. No.:
151390

Recommended bulb:
PHILIPS LEDspot 4W
36°, 3000K, 310cd, 165lm
560084



SQUARE DICE 2 Design by CDC/FGL

230~

>2,5m	QR/QT
≤2,5m	LED ESL

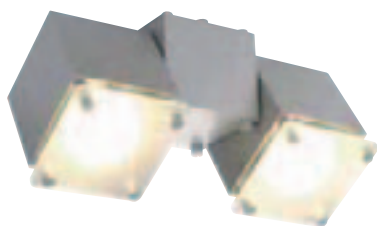
Socket/Bulb:
 GU10/GU10 (excl.)
 2x 50W max.

Versions:
 silver grey
 Glass satined

Art. No.:
 151142

Material:
 Aluminium/glass

Dimensions:
 W/H/D: 21,5/7,5/11,5 cm

Recommended bulb:
 35W EnergySaver ≈ 50W
 20°, 2800K, 1200cd
 575370

Recommended bulb:
 LEDspot 4W
 36°, 3000K, 310cd, 165lm
 560084

SQUARE DICE 1 Design by CDC/FGL

230~

>2,5m	QR/QT
≤2,5m	LED ESL

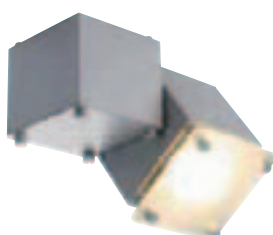
Socket/Bulb:
 GU10/GU10 (excl.)
 50W max.

Versions:
 silver grey
 Glass satined

Art. No.:
 151132

Material:
 Aluminium/glass

Dimensions:
 W/H/D: 14/7,5/11,5 cm

Recommended bulb:
 35W EnergySaver ≈ 50W
 20°, 2800K, 1200cd
 575370

Recommended bulb:
 LEDspot 4W
 36°, 3000K, 310cd, 165lm
 560084



ENOLA_B

WALL AND CEILING LUMINAIRE SERIES





ENOLA_B SPOT 1

230~



Socket/Bulb:
GU10/GU10 (excl.)
up to max. L: 8 cm
50W max.

Versions:
white
silver grey/black

Art. No.:
151821
151824

Material:
Aluminium/steel

Dimensions:
W/H/D: 14/13,5/6,7 cm

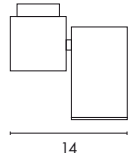

ENOLA_B SPOT 2

230~



Socket/Bulb:
GU10/GU10 (excl.)
up to max. L: 8 cm
2x 50W max.

Versions:
white
silver grey/black

Art. No.:
151831
151834

Material:
Aluminium/steel

Dimensions:
W/H/D: 21/13,5/6,7 cm

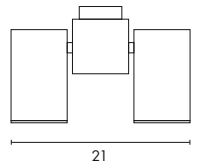

ENOLA_B CL-1

230~

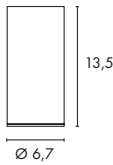

Socket/Bulb:
GU10/GU10 (excl.)
up to max. L: 8,5 cm
35W max.

Versions:
white
silver grey/black

Art. No.:
151811
151814

Material:
Aluminium

Dimensions:
Ø/H: 6,7/13,5 cm

ENOLA_B UP-DOWN

230~

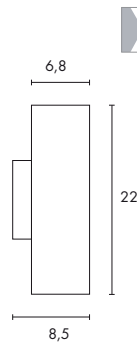

Socket/Bulb:
GU10/GU10 (excl.)
up to max. L: 8,5 cm
2x 050W max.

Versions:
white
silver grey/black

Art. No.:
151801
151804

Material:
Aluminium/steel

Dimensions:
W/H/D: 6,8/22/8,5 cm

Recommended bulb:
11W EnergySaver
2700K, 220lm
508920



Recommended bulb:
PHILIPS PowerLED 4W
25°, 3000K, 700cd, 180lm
560013



Recommended accessory:
Decoration ring, black, steel
Ø/H: 0,64/0,24 cm
151840



Enola_B Spot 2, with optional black decoration ring.

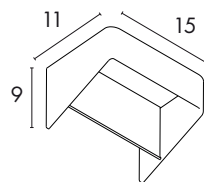
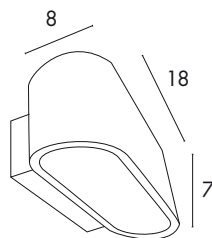

OSSA DACU SPACE

WALL LUMINAIRES

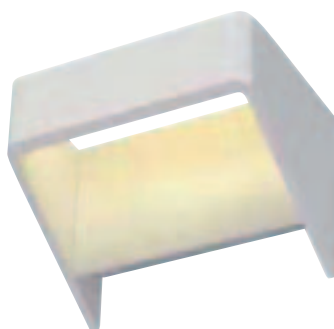

OSSA R7S



Socket/Bulb:
R7s/R7s, 78 mm (excl.)
100W max.

Material:
Aluminium/steel

Dimensions:
W/H/D: 18/7/8 cm

Versions:
white

alu brushed

Art. No.:
151451

151456

Recommended bulb:

 Plusline ES
80W EnergySaver \approx 100W
2900K, 1400lm, EEK=C
519231



DACU SPACE



Bulb:
PlanarLED (incl.)
4W

Material:
Aluminium

Accessory/Included parts:
LED driver (incl.)

Versions:
LED 3000K
white
alu brushed/white

Art. No.:
151471
151476





LED SHELL

230~

LED
1 pce.

0,4

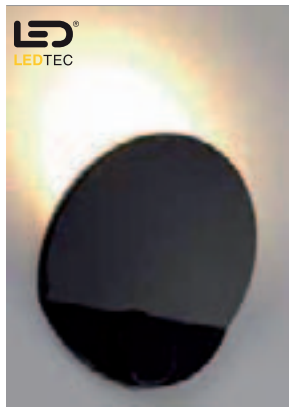

Bulb:
PowerLED (incl.)
4W

Material:
Aluminium

Dimensions:
Ø/D: 18/7,3 cm

Versions:
LED 3000K
black, high gloss finished
white, high gloss finished

Art. No.:
151370
151371

LED SAIL 1

230~
mA
700LED
1 pce.

60°



0,75



Bulb:
PowerLED (incl.)
3W

Material:
Aluminium/steel

Dimensions:
W/H/D: 21/20/6 cm

Accessory/Included parts:
LED driver (incl.)

Versions:
LED 3000K
black, high gloss finished
white, high gloss finished

Art. No.:
151600
151601

LED SAIL 2

230~
mA
700LED
2 pce.

60°



0,94



Bulb:
PowerLED (incl.)
2x 3W

Material:
Aluminium/steel

Dimensions:
W/H/D: 21/30/6 cm

Accessory/Included parts:
LED driver (incl.)

Versions:
LED 3000K
black, high gloss finished
white, high gloss finished

Art. No.:
151610
151611





DACU UP-DOWN

WALL LUMINAIRE SERIES



DACU UP-DOWN

230~



IP44

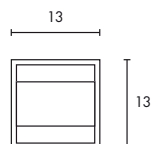

Socket/Bulb:
G9/G9 (excl.)
40W max.

Material:
Aluminium

Versions:
silver grey
alu brushed

Art. No.:
227132
227136

Recommended bulb:
33W EnergySaver \approx 40W
2700K, 460lm, EEK=C
519451



DACU UP-DOWN LED

230~

mA

350



LED

2 pce.



120°



IP44

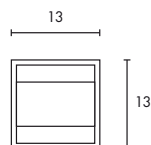

Bulb:
PowerLED (incl.)
2x 1W

Material:
Aluminium

Accessory/Included parts:
LED driver (incl.)

Versions:
silver grey
LED 2700K

Art. No.:
227262

DACU UP-DOWN LED BEAM

230~

mA

350



LED

2 pce.



Beam

8°

Flood

120°



IP44

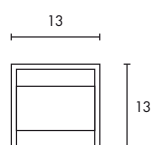

Bulb:
PowerLED (incl.)
2x 1W

Material:
Aluminium

Accessory/Included parts:
LED driver (incl.)

Versions:
silver grey
LED 2700K

Art. No.:
227252



DACU LED Design by CDC

230~
mA
350 LED
2 pce. IP44



Bulb:
PowerLED (incl.)
2x 1W

Material:
Aluminium

Dimensions:
W/H/D: 13/13/6,2 cm

Accessory/Included parts:
LED driver (incl.)

Versions:
silver grey
LED 6000K
LED 3000K

Art. No.:
152041
152042

DACU G9 Design by CDC

230~ IP44



Socket/Bulb:
G9/G9 (excl.)
40W max.

Material:
Aluminium

Dimensions:
W/H/D: 13/13/6,2 cm

Versions:
silver grey
alu brushed

Art. No.:
227102
227106

Recommended bulb:
33W EnergySaver ± 40W
2700K, 460lm, EEK=C
519451



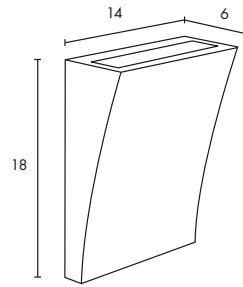

Delwa Wide

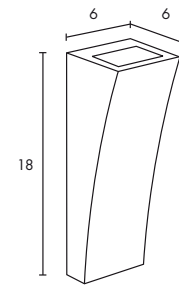

Delwa/Delwa Blue

DELWA BLUE

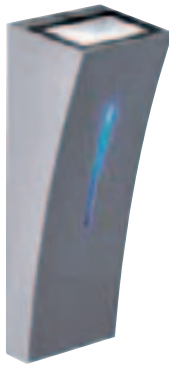

Bulb:
PowerLED (incl.)
LED white 5W
LED blue 1W

Versions:
silver grey
LED 6000K/blue

Art. No.:
230767

Material:
Aluminium/glass

Accessory/Included parts:
LED driver (incl.)

Note:
With blue deco light.

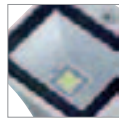

DELWA



Bulb:
PowerLED (incl.)
4W

Versions:
white
LED 6000K
LED 3000K

Art. No.:
231901
231902

Material:
Aluminium/glass

silver grey
LED 6000K
LED 3000K

231911
231912



DELWA WIDE Design by CDC



Bulb:
PlanarLED (incl.)
2x 3,5W

Versions:
LED 3000K
white
silver grey

Art. No.:
230791
230794

Material:
Aluminium/glass

Accessory/Included parts:
LED driver (incl.)





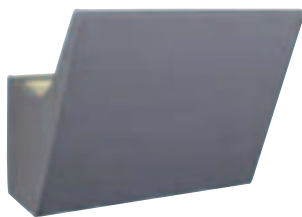
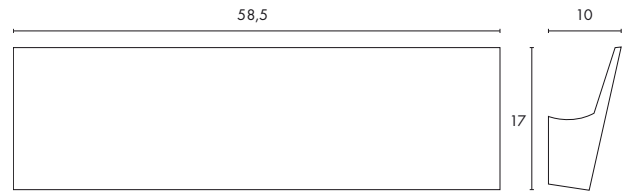
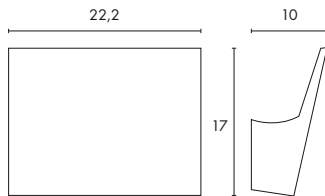
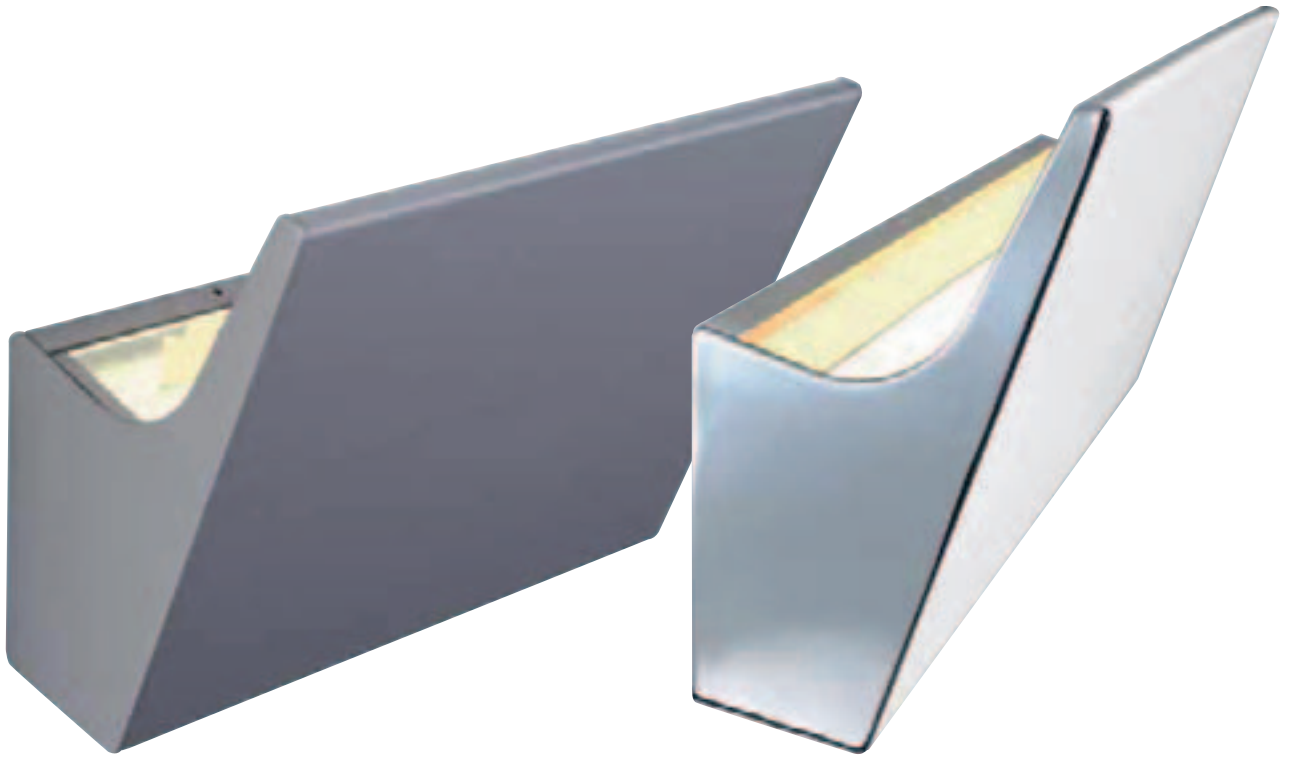

SOLF TC-D Design by CDC/FGL



Socket/Bulb:
G24d-3/TC-D EnergySaver (excl.)
26W

Versions:
silver grey

Art. No.:
157604

Material:
Aluminium

Accessory/Included parts:
Low-loss ballast (incl.)

Recommended bulb:
26W, 2700K, 1800lm, EEK=B
508226



SOLF T5 Design by CDC/FGL



Socket/Bulb:
G5/T5 EnergySaver (excl.)
24W

Versions:
white/chrome

Art. No.:
157611

Material:
Aluminium

Accessory/Included parts:
Electronic ballast (incl.)

Recommended bulb:
24W, 3000K, 1700lm
548024



Note:
The lamp can be mounted with light emission upwards or downwards.

(PU see page 661)



HALF PIPE Design by CDC

230V
350mA



LED
3 pce.



LED
LEDTEC



Bulb:
PowerLED (incl.)
3x 1W

Material:
Aluminium

Dimensions:
W/H/D: 17,6/9/5,6 cm

Accessory/Included parts:
LED driver (incl.)

Versions:
alu brushed
LED 6000K
LED 3000K
LED blue

Art. No.:
149411
149412
149417

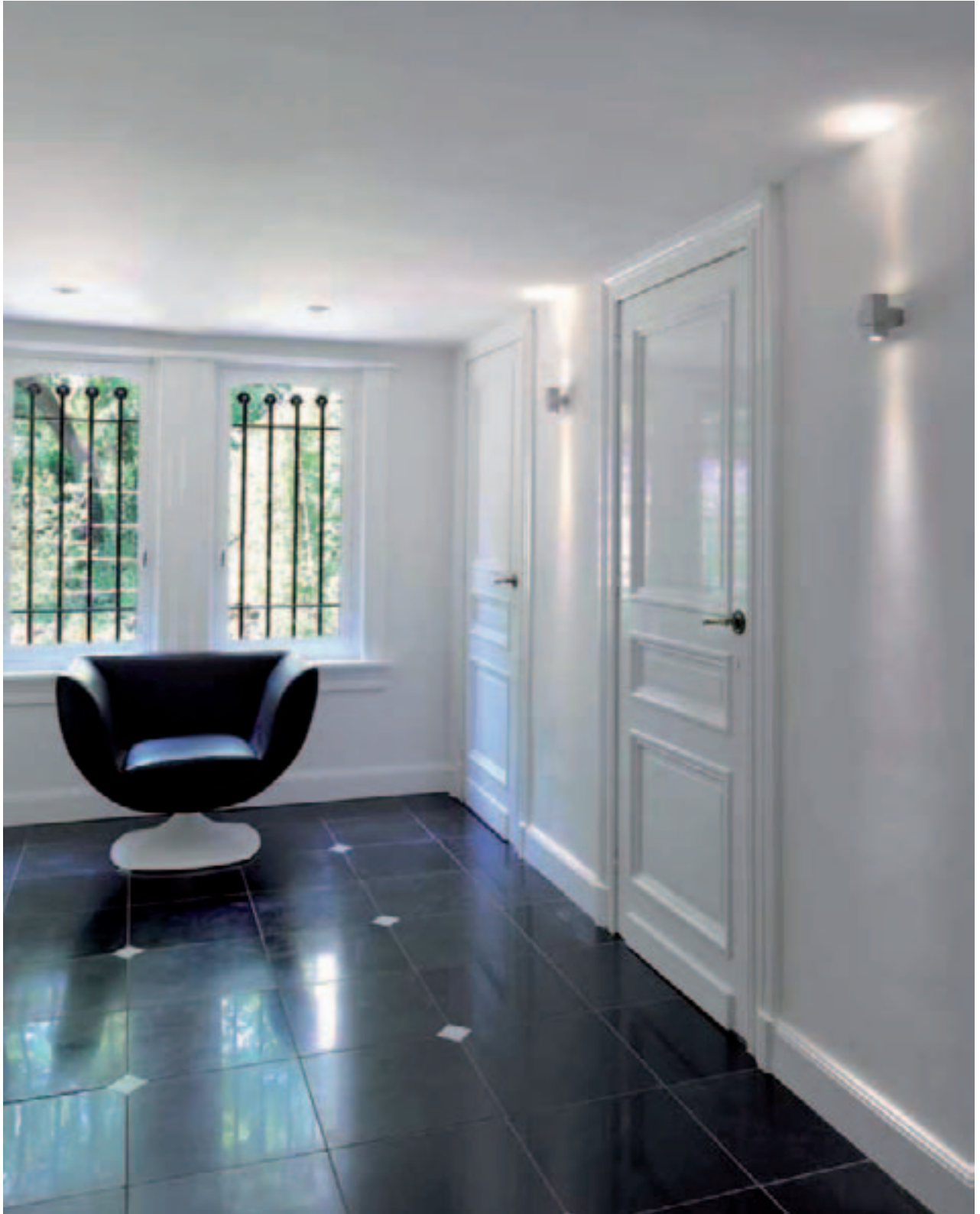

AIDAN UP-DOWN

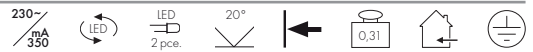

Bulb:
PowerLED (incl.)
2x 1W

Material:
Aluminium

Dimensions:
W/H/D: 4,6/9/7,5 cm

Accessory/Included parts:
LED driver (incl.)

Versions:
alu brushed
LED white
LED warm white

Art. No.:
151361
151362



AITES 16 LED

12~



1α 40°



IP23



Bulb:
SMD LED (incl.)
1,5W total

Material:
Aluminium/plastic

Dimensions:
W/H/D: 9/9/1,8 cm
Supply line-L: 2 m

Accessory/Included parts:
Mounting frame (incl.)
Conventional transformer (excl.)

Note:
Operate only with conventional transformer.

Versions:
alu brushed
LED white
LED warm white

Art. No.:
230251
230252

Recommended connection:

Convent. transformer, 10VA, 12V~
451010

**Recommended connection:**

LED power unit box installation
12VA, 12V=
470545

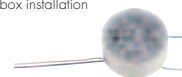

AITES 20 LED

12~



1α 40°



IP23



Bulb:
SMD LED (incl.)
1,8W total

Material:
Aluminium/plastic

Dimensions:
W/H/D: 22,3/5/1,8 cm
Supply line-L: 2 m

Accessory/Included parts:
Mounting frame (incl.)
Conventional transformer (excl.)

Note:
Operate only with conventional transformer.

Versions:
alu brushed
LED white
LED warm white

Art. No.:
230261
230262

Recommended connection:

Convent. transformer, 10VA, 12V~
451010

**Recommended connection:**

LED power unit box installation
12VA, 12V=
470545

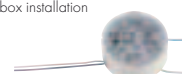







SLEEK LED UP-DOWN

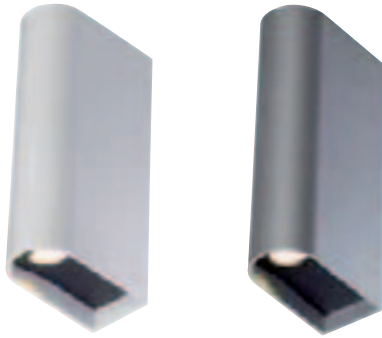

Bulb:
PowerLED (incl.)
2x 1W

Material:
Aluminium

Dimensions:
W/H/D: 3,7/15/7 cm

Accessory/Included parts:
LED driver (incl.)

Versions:
LED 3000K
white
silver grey

Art. No.:
151301
151304

QUAD 2

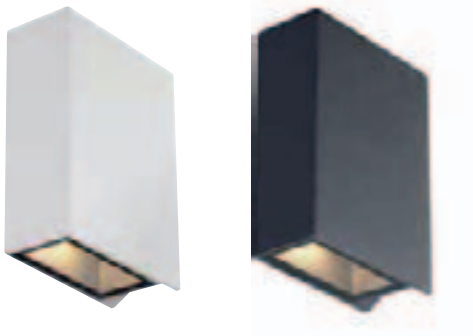

Bulb:
PowerLED (incl.)
2x 3W

Material:
Aluminium/glass

Dimensions:
W/H/D: 4/12,4/9,5 cm

Accessory/Included parts:
LED driver (incl.)

Versions:
LED 3000K
white
anthracite

Art. No.:
232471
232475

QUAD 1

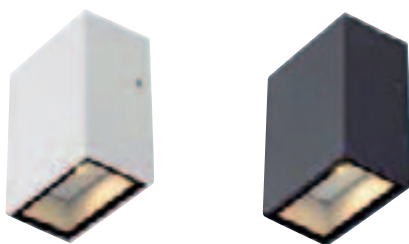

Bulb:
PowerLED (incl.)
3W

Material:
Aluminium/glass

Dimensions:
W/H/D: 6,4/8,7/4,2 cm

Accessory/Included parts:
LED driver (incl.)

Versions:
LED 3000K
white
anthracite

Art. No.:
232461
232465



OVA WALL 1

230~



Socket/Bulb:
GU10/GU10 (excl.)
2x 50W max.

Material:
Aluminium

Dimensions:
W/H/D: 6/28/13,5 cm

Versions:
silver grey

Art. No.:
147112

Recommended bulb:
35W EnergySaver \neq 50W
20°, 2800K, 1200cd
575370



NEPRO WALL

230~



Series: Page 318



Socket/Bulb:
R7s/R7s, 118 mm (excl.)
200W max.

Material:
Aluminium

Dimensions:
W/H/D: 17,5/6/17 cm

Versions:
silver grey

Art. No.:
151982

Recommended bulb:
200W EnergySaver \neq 300W
2700K, 4000lm, EEK=C
519223



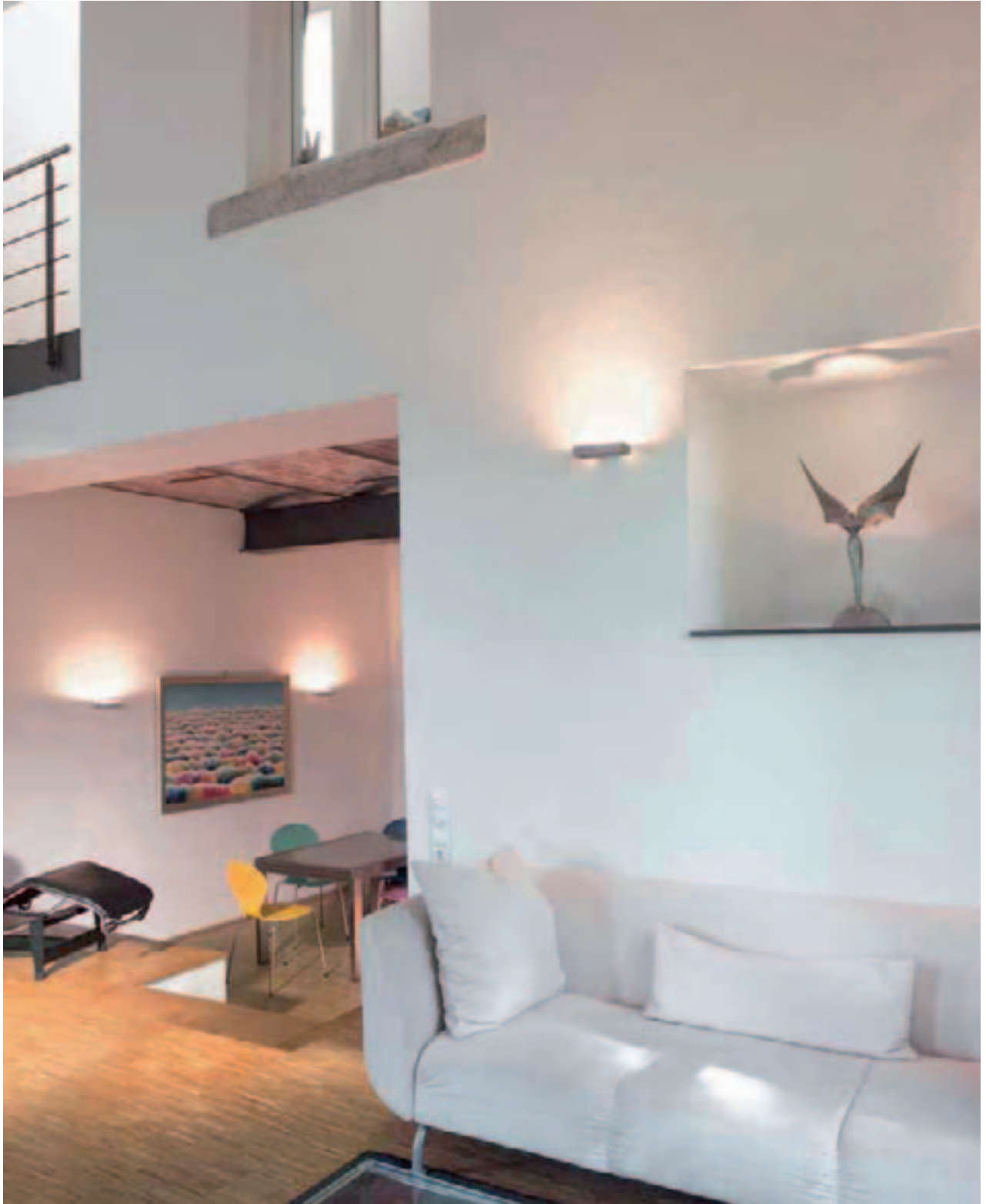

ANDREAS Design by CDC

230~

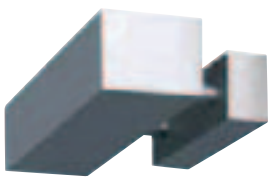

Socket/Bulb:
R7s/R7s, 118 mm (excl.)
100W max.

Versions:
silver grey

Art. No.:
151400

Material:
Aluminium

chrome

151404

Dimensions:
W/H/D: 20,5/5,5/11 cm

Recommended bulb:
100W EnergySaver ± 150W
2700K, 1900lm, EEK=C
519221

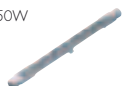

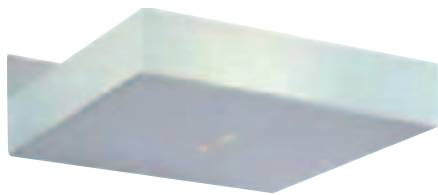

HARI



230~



Socket/Bulb:
G9/G9 (excl.)
40W max.

Versions:
silver grey
Glass satined

Art. No.:
151674

Material:
Steel/glass

Dimensions:
W/H/D: 12,5/2,5/13 cm

Recommended bulb:
33W EnergySaver ≈ 40W
2700K, 460lm, EEK=C
519451



MINI BEAM Design by CDC



230~



Socket/Bulb:
G9/G9 (excl.)
40W max.

Versions:
silver grey

Art. No.:
151490

Material:
Aluminium

Dimensions:
W/H/D: 7/11/11 cm

Recommended bulb:
33W EnergySaver ≈ 40W
2700K, 460lm, EEK=C
519451



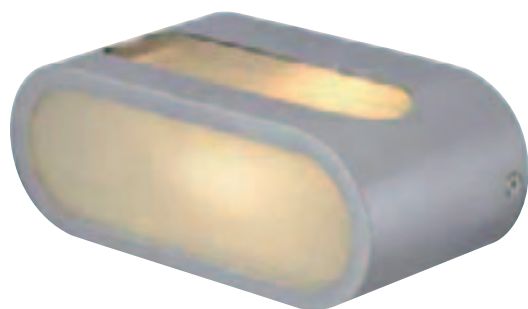
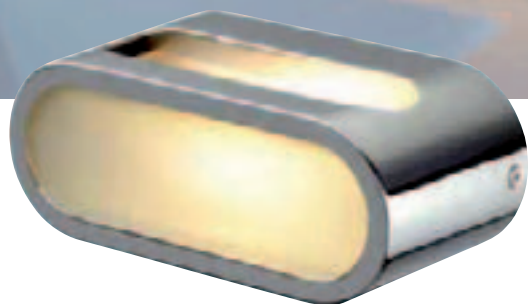

NEW ANDREAS



230~



Socket/Bulb:
R7s/R7s, 118 mm (excl.)
100W max.

Material:
Aluminium/glass

Dimensions:
W/H/D: 18/7/9 cm

Versions:
Structure glass frosted
chrome

silver grey

Art. No.:
151422

151424

Recommended bulb:
100W EnergySaver \neq 150W
2700K, 1900lm, EEK=C
519221



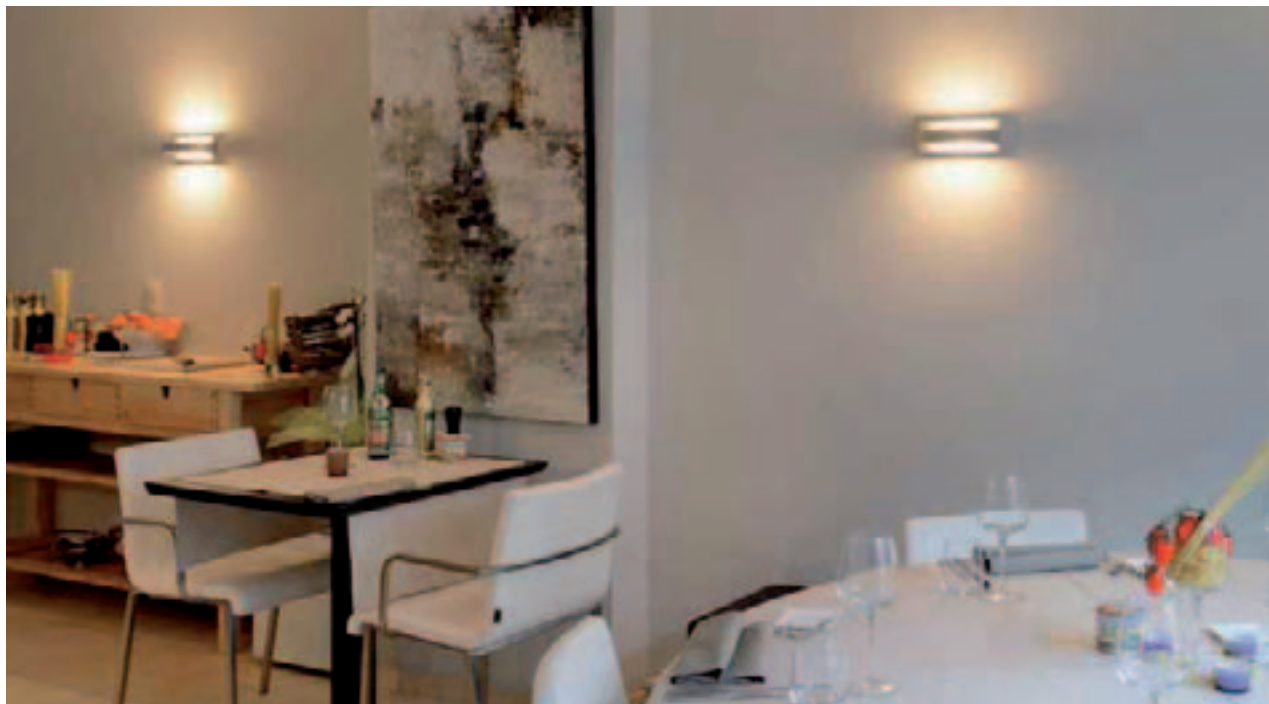

TANI

230~



Socket/Bulb:
R7s/R7s, 118 mm (excl.)
200W max.

Material:
Aluminium/glass

Dimensions:
W/H/D: 23/8,5/8,5 cm

Versions:
chrome
alu brushed

Art. No.:
147562
147566

Recommended bulb:

PHILIPS Plusline ES
160W EnergySaver \approx 200W
2900K, 3100lm, EEL=C
519241



CHROMBO Design by CDC

230~

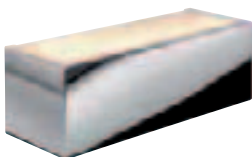

Socket/Bulb:
G9/G9 (excl.)
40W max.

Material:
Steel/glass

Dimensions:
W/H/D: 20/6,9/6,9 cm

Versions:
chrome
Structure glass, frosted

Art. No.:
151462

Recommended bulb:

33W EnergySaver \approx 40W
2700K, 460lm, EEK=C
519451



CHROMBO TC-S

230~

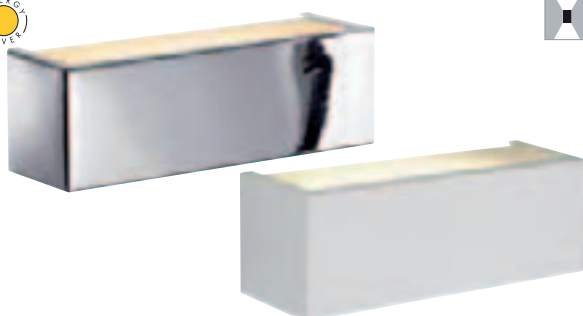

Socket/Bulb:
G23/TC-S EnergySaver (excl.)
11W

Material:
Steel/glass

Dimensions:
W/H/D: 30/10/9 cm

Accessory/Included parts:
Low-loss ballast (incl.)

Versions:
Glass satined
chrome
white matt

Art. No.:
155260
155261

Recommended bulb:

11W, 2700K, 900lm, EEK=A
508310





WL 149 R7s

230~

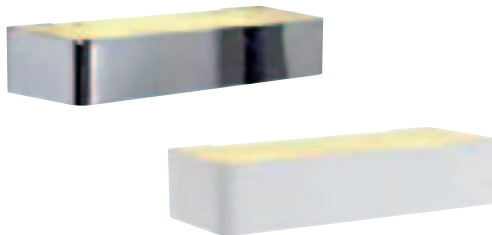

Socket/Bulb:
R7s/R7s, 78 mm (excl.)
60W max.

Material:
Steel/glass

Dimensions:
W/H/D: 24/5/10 cm

Note:
Cannot be used as a shelf!

Versions:
Glass satined
white matt
chrome

Art. No.:
149471
149472

Recommended bulb:
48W EnergySaver \neq 60W
2700K, 750lm, EEK=C
519206



WL 149 G9

230~

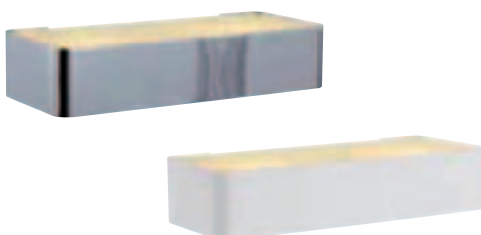

Socket/Bulb:
G9/G9 (excl.)
2x 42W max.

Material:
Steel/glass

Dimensions:
W/H/D: 24/5/10 cm

Note:
Cannot be used as a shelf!

Versions:
Glass satined
white matt
chrome

Art. No.:
149501
149502

Recommended bulb:
9W EnergySaver
4000K, 405lm, EEK=A
508941





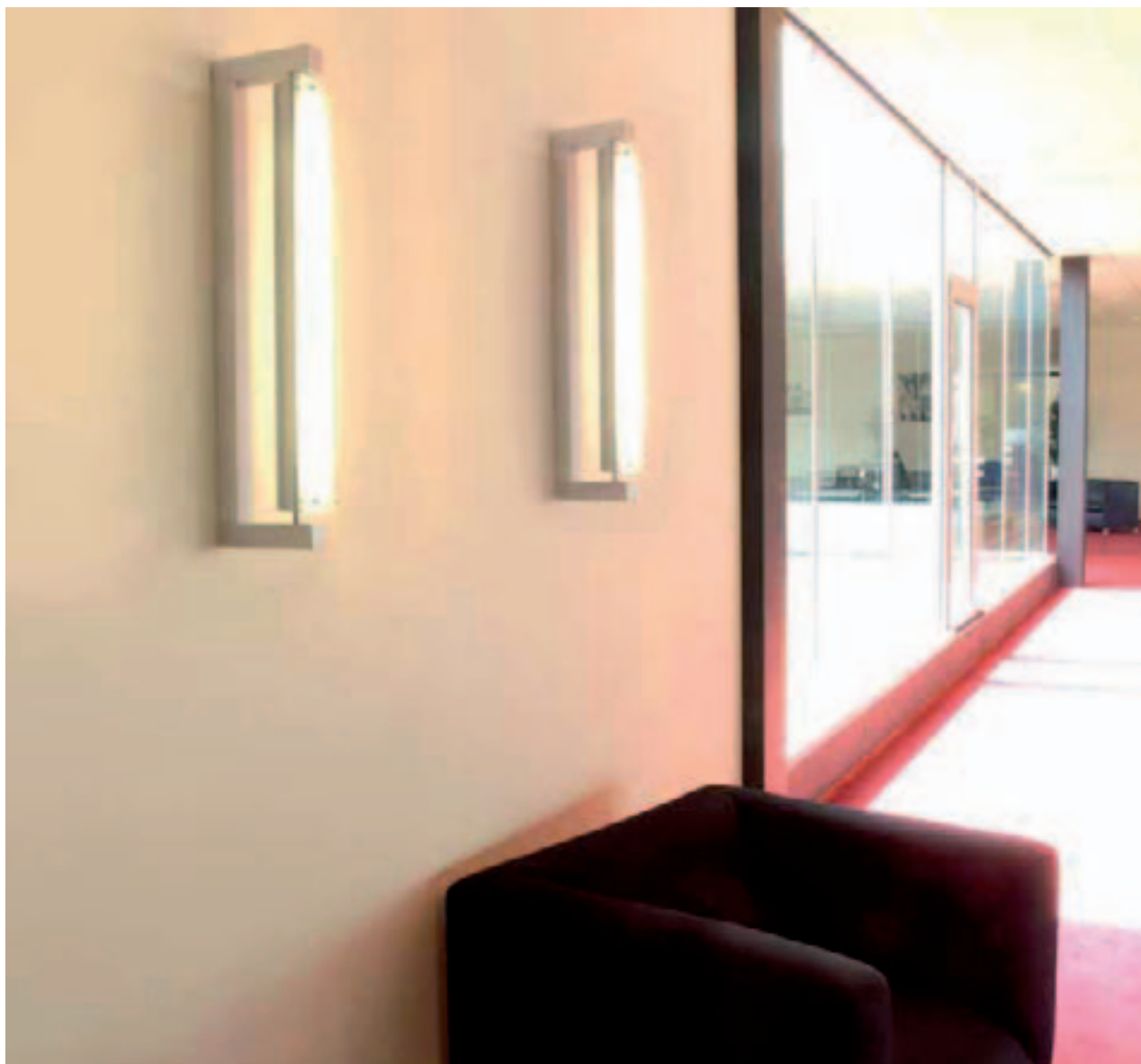

NEPRO LINE

230~

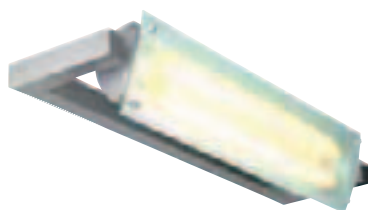

Socket/Bulb:
G5/T5 EnergySaver (excl.)
2x 24W

Versions:
silver grey

Art. No.:
157052

Material:
Aluminium/glass

Dimensions:
W/H/D: 70,5/14/20,5 cm

Accessory/Included parts:
Electronic ballast (incl.)

Recommended bulb:
24W, 3000K, 1700lm
548024

(PU see page 661)

WORKLIGHT WAVE WL-1

230~

Series: Page 070

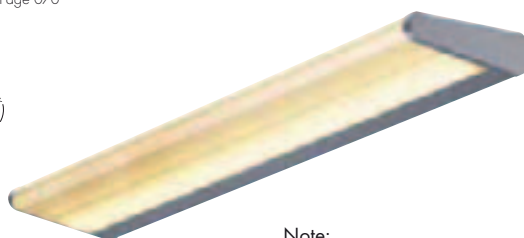

Note:
Calculated acrylic diffuser from
BWF.

Socket/Bulb:
G5/T5 EnergySaver (excl.)
39W

Versions:
silver grey

Art. No.:
157584

Material:
Aluminium/acrylic

Dimensions:
W/H/D: 90/6/18 cm

Accessory/Included parts:
Electronic ballast (incl.)

Recommended bulb:
39W, 3000K, 3500lm
548039

(PU see page 661)



L-LINE 60 Design by CDC

230~



IP43



Socket/Bulb:
G5/T5 EnergySaver (excl.)
24W



Material:
Aluminium/PC

Dimensions:
Outer dimensions:
W/H/D: 60/7/7 cm
Clearance dimensions:
W/H/D: 60/3,5/3,5 cm

Accessory/Included parts:
Electronic ballast (incl.)

Note:
max. mechanical load: 3 kg

Versions:
silver grey

Art. No.:
157414

Recommended bulb:
24W, 3000K, 1700lm
548024

(PU see page 661)



L-LINE 120 Design by CDC

230~



IP43



Socket/Bulb:
G5/T5 EnergySaver (excl.)
28W



Material:
Aluminium/PC

Dimensions:
Outer dimensions:
W/H/D: 120/7/7 cm
Clearance dimensions:
W/H/D: 120/3,5/3,5 cm

Accessory/Included parts:
Electronic ballast (incl.)

Note:
max. mechanical load: 3 kg

Versions:
silver grey

Art. No.:
157424

Recommended bulb:
28W, 3000K, 2640lm
548028

(PU see page 661)

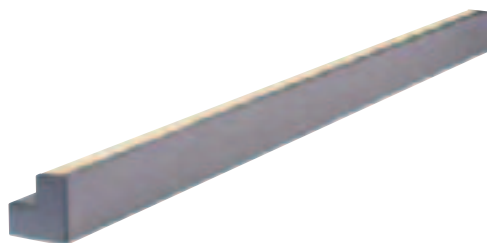



T5 DUOSPOT

230~  LED 2 pcs.  Ballast EEL=A2  LED 60°   350°  100°  2,64  



Socket/Bulb:
G5/T5 EnergySaver (excl.)
21W
and
2x PowerLED, 1W (incl.)

Note:
T5 bulb and LED spots can be
switched separately.

Material:
Aluminium

Versions:
alu brushed
LED white

Art. No.:
155162

Dimensions:
W/H/D: 96/12/16,2 cm

Accessory/Included parts:
Electronic ballast (incl.)
LED driver (incl.)
Switch (incl.)

Recommended bulb:
21W, 3000K, 1910lm
548021

(PU see page 661)

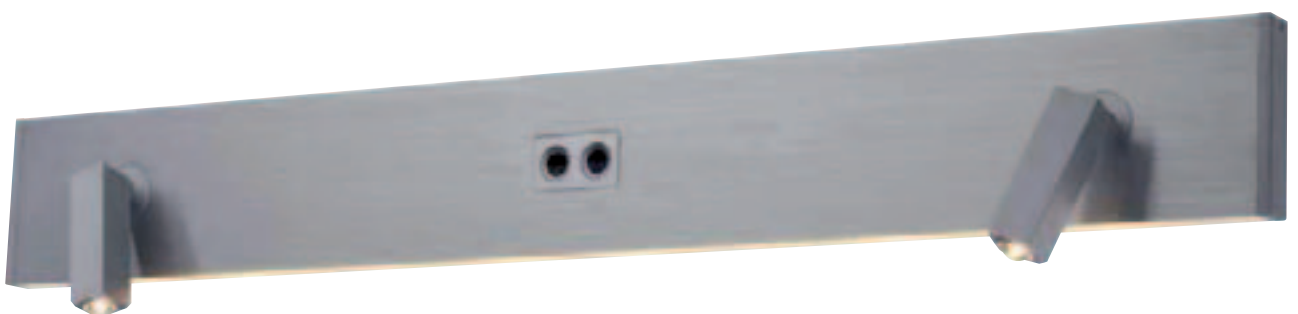
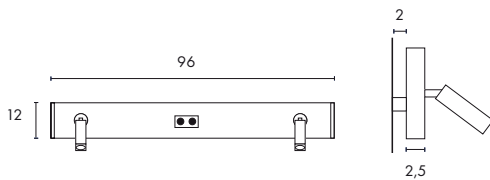



BOWTOW

230~



IP23



Socket/Bulb:
S14d/line bulb (excl.)
60W



Material:
Steel

Dimensions:
W/H/D: 57/4/10 cm

Versions:
chrome

Art. No.:
157322

Recommended bulb:
60W, 2700K, 420lm, EEK=G
50 cm, matt
590151

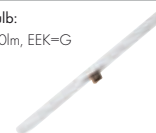

BOWTOW GLASS

230~



IP21



Socket/Bulb:
G5/T5 EnergySaver (excl.)
24W



Material:
Steel/glass

Dimensions:
W/H/D: 64,5/4,5/10,5 cm

Accessory/Included parts:
Electronic ballast (incl.)
2 partial satined glass panes (incl.)

Note:
max. mechanical load: 3 kg .

Versions:
chrome

Art. No.:
157472

Recommended bulb:
24W, 3000K, 1700lm
548024

(PU see page 661)

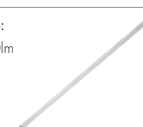



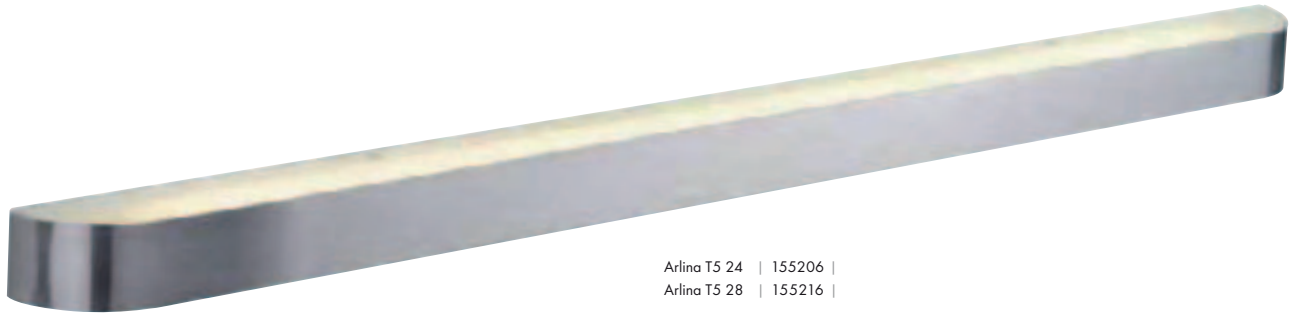
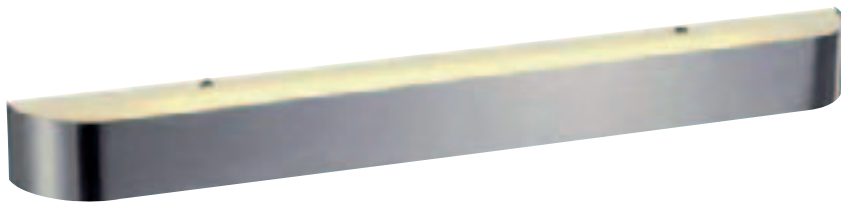

Arlina T5 24 | 155206 |
Arlina T5 28 | 155216 |

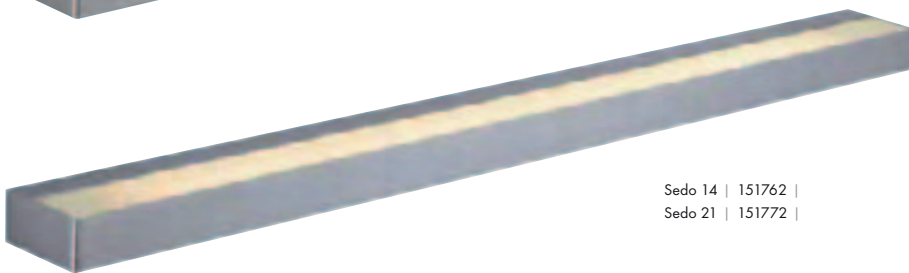
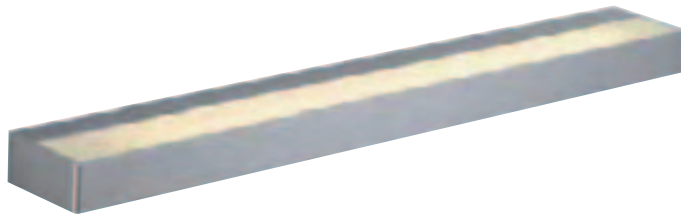

Sedo 14 | 151762 |
Sedo 21 | 151772 |

ARLINA T5 24/28



Material:
Aluminium/glass

Recommended bulb:
24W, 3000K, 1700lm
548024

Accessory/Included parts:
Electronic ballast (incl.)

(PU see page 661)

Note:
Cannot be used as a shelf!

Recommended bulb:
28W, 3000K, 2640lm
548028

(PU see page 661)

SEDO 14/21



Material:
Aluminium/glass

Recommended bulb:
14W, 3000K, 1230lm
548014

Accessory/Included parts:
Electronic ballast (incl.)

(PU see page 661)

Note:
Cannot be used as a shelf!

Recommended bulb:
21W, 3000K, 1910lm
548021

(PU see page 661)

ARLINA T5 / SEDO

230~



Article No.	Description	Colour	Voltage in AC	Socket/Bulb (excl.)	Wattage Bulb	Length in cm	Width in cm	Height in cm	Weight in kg	Price
155206	Arlina T5 24	alu brushed/glass satined	230V	G5/T5 EnergySaver	24W	67	6,5	6	2,2	
155216	Arlina T5 28	alu brushed/glass satined	230V	G5/T5 EnergySaver	28W	128	7,5	6	3,8	
151762	Sedo 14	alu brushed/glass satined	230V	G5/T5 EnergySaver	14W	59,5	8,5	4	1,3	
151772	Sedo 21	alu brushed/glass satined	230V	G5/T5 EnergySaver	21W	89,5	8,5	4	1,8	



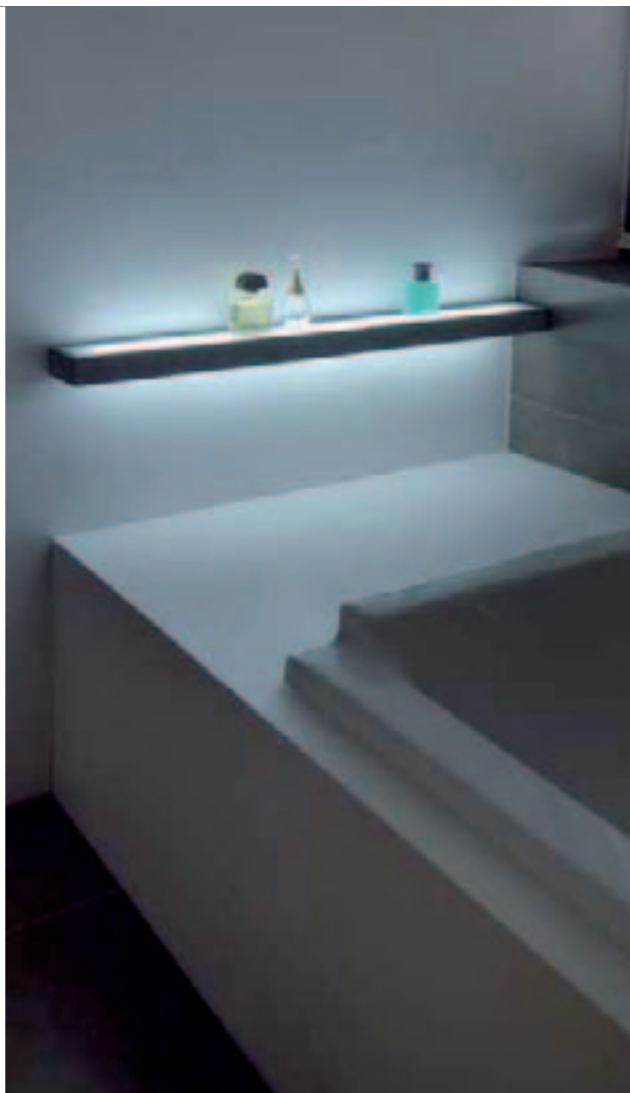
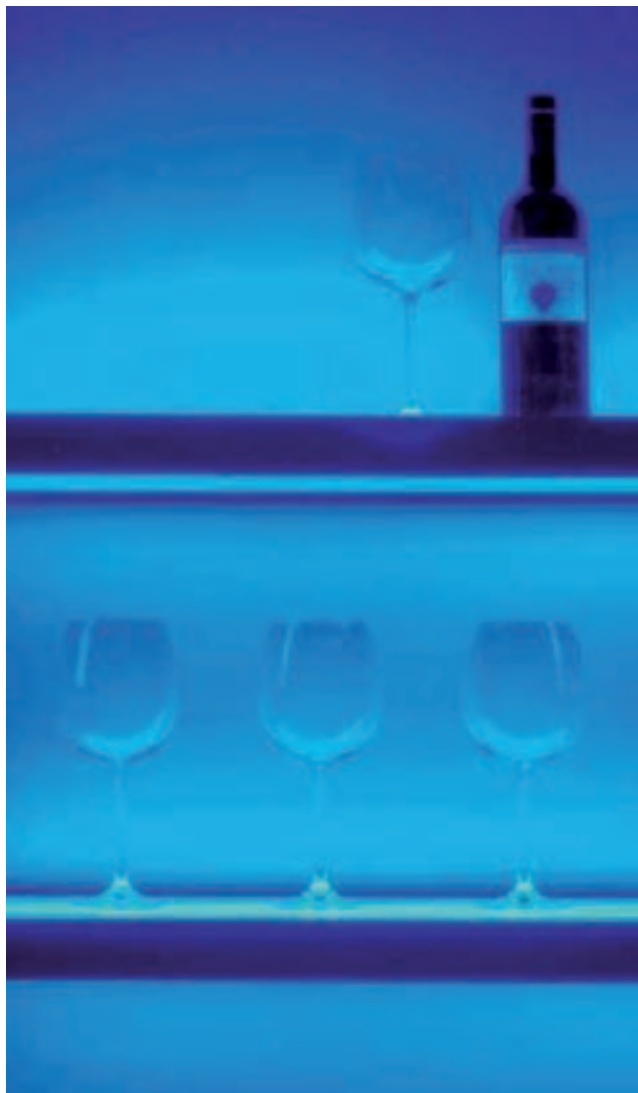

FLAT 121

230~

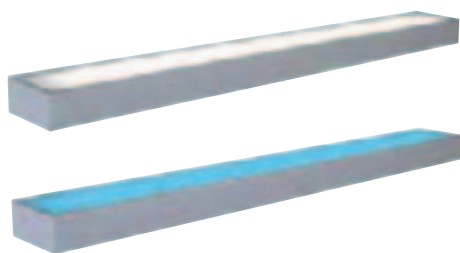

Socket/Bulb:
G5/T5 EnergySaver (excl.)
21W

Material:
Aluminium/glass

Dimensions:
W/H/D: 91/5/10 cm

Note:
Mechanical load: 15 kg max.
The use of coloured T5 bulbs is possible.

Accessory/Included parts:
Electronic ballast (incl.)

Versions:
alu
Glass satined

Art. No.:
157192

Recommended bulb:
21W, 3000K, 1910lm
548021

(PU see page 661)

FLAT 221

230~

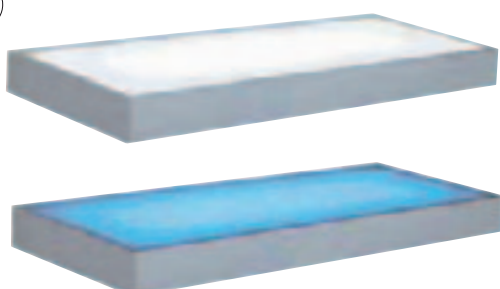

Socket/Bulb:
G5/T5 EnergySaver (excl.)
2x 21W

Material:
Aluminium/glass

Dimensions:
W/H/D: 91/5/22 cm

Note:
Mechanical load: 10 kg max.
The use of coloured T5 bulbs is possible.

Accessory/Included parts:
Electronic ballast (incl.)

Versions:
alu
Glass satined

Art. No.:
157202

Recommended bulb:
21W, 3000K, 1910lm
548021

(PU see page 661)



SIGHT 24 Design by CDC

230~

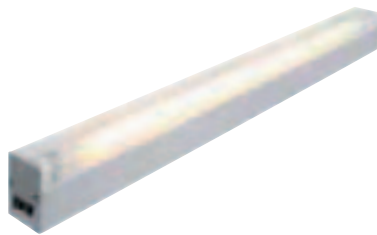

Socket/Bulb:
G5/T5 EnergySaver (excl.)
24W

Material:
Aluminium/acrylic

Dimensions:
L/W/H: 59/4/6 cm

Accessory/Included parts:
Electronic ballast (incl.)
Switch (incl.)

Versions:
silver grey
alu brushed

Art. No.:
160202
160206

Recommended bulb:
24W, 3000K, 1700lm
548024

(PU see page 661)

SIGHT 54 Design by CDC

230~

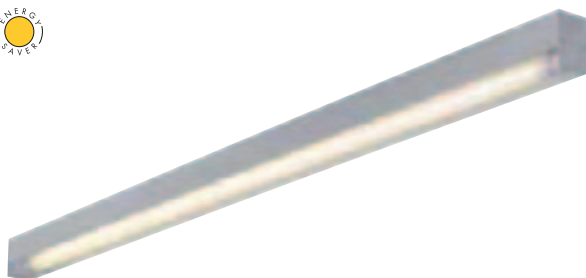

Socket/Bulb:
G5/T5 EnergySaver (excl.)
54W

Material:
Aluminium/acrylic

Dimensions:
L/W/H: 119/4/6 cm

Accessory/Included parts:
Electronic ballast (incl.)

Versions:
silver grey
alu brushed

Art. No.:
160212
160216

Recommended bulb:
54W, 3000K, 5000lm
548054

(PU see page 661)



Q-LINE

Design by CDC

Series: Page 066



Q-LINE WALL

Design by CDC

230~



Socket/Bulb:
G5/T5 EnergySaver (excl.)
35W

Material:
Aluminium anodized
Diffusor acrylic

Dimensions:
W/H/D: 151/5,7/10,2 cm

Accessory/Included parts:
Electronic ballast (incl.)

Versions:
white/chrome
alu/anthracite

Art. No.:
155001
155002

Recommended bulb:
35W, 3000K, 3650lm
548035

(PU see page 661)



ACCESSORY for Q-Line Wall

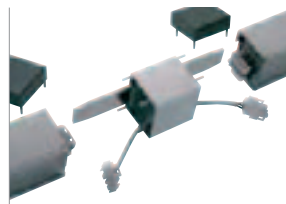

Longitudinal connector
white/chrome
alu
Art. No.:
155051
155052

L/W/H: 6/5,7/5,1 cm
20 cm cable (incl.)
For the straight connection of two Q-Line profiles.





TIDUR WALL profile lamp



Socket/Bulb:
G5/T5 EnergySaver (excl.)
2x 21W
and
PowerLED (incl.)
2x 3W

Material:
Aluminium

Dimensions:
W/H/D: 200/12/16,2 cm

Accessory/Included parts:
Electronic ballast (incl.)
LED converter (incl.)
Switch (incl.)

Note:
Wall illumination and LED spots
can be switched separately.

Versions:	Art. No.:
alu brushed	146282
LED warm white	146284
LED white	

Recommended bulb:
21W, 3000K, 1910lm
548021

(PU see page 661)

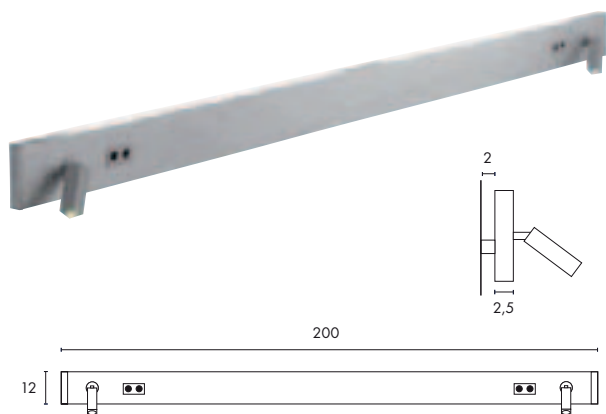

ASTO TUBE Design by CDC



Series: Page 157



Socket/Bulb:
GU10/GU10 (excl.)
up to max. Ø/L: 6,4/8,1 cm
50W max.
or
GU10 LED (excl.)

Material:
Aluminium

Dimensions:
Head-Ø/H: 7/12 cm
Canopy-L/W/H: 13/7/2,5 cm

Accessory/Included parts:
Switch (incl.)

Versions:	Art. No.:
white	146411
alu brushed	146416

Recommended bulb:
35W EnergySaver ≈ 50W
20°, 2800K, 1200cd
575370



Recommended bulb:
PHILIPS PowerLED 4W
25°, 3000K, 700cd, 180lm
560013



ONIO T5 Design by CDC

230~



Socket/Bulb:
G5/T5 EnergySaver (excl.)
24W

Versions:
silver grey

Art. No.:
157394

Material:
Aluminium

Dimensions:
W/H/D: 68/4,5/9 cm

Accessory/Included parts:
Electronic ballast (incl.)

Recommended bulb:
24W, 3000K, 1700lm
548024

(PU see page 661)

ONIO T5 TWIST Design by CDC

230~



Socket/Bulb:
G5/T5 EnergySaver (excl.)
24W

Versions:
silver grey

Art. No.:
157544

Material:
Aluminium

Dimensions:
W/H/D: 71,7/4,5/15 cm

Accessory/Included parts:
Electronic ballast (incl.)

Recommended bulb:
24W, 3000K, 1700lm
548024

(PU see page 661)

ONIO R7s Design by CDC

230~



Socket/Bulb:
R7s/R7s, 78 mm (excl.)
60W max.

Versions:
silver grey

Art. No.:
157404

Material:
Aluminium

Dimensions:
W/H/D: 30/4,5/13,5 cm

Recommended bulb:
48W EnergySaver \approx 60W
2700K, 750lm, EEK=C
519206





SWORD WL 160

230~

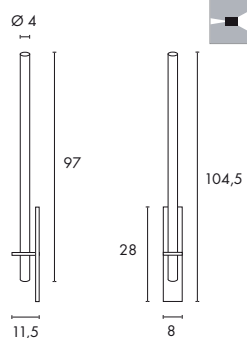

Socket/Bulb:
G5/T5 EnergySaver (excl.)
21W

Material:
Aluminium

Accessory/Included parts:
Electronic ballast (incl.)

Versions:
alu brushed

Art. No.:
149466

Recommended bulb:
21W, 3000K, 1910lm
548021

(PU see page 661)





CREST WL-1 Design by CDC

Series: Page 096



230~



Socket/Bulb:
G5/T5 EnergySaver (excl.)
2x 24W

Material:
Zinc, chrome-plated/PP

Dimensions:
W/H/D: 13,5/73/9 cm

Accessory/Included parts:
Electronic ballast (incl.)

Versions:
chrome/white

Art. No.:
133782

Recommended bulb:
24W, 3000K, 1700lm
548024

(PU see page 661)



ONIO HIT-TC TWIST Design by CDC

230~



HiEFFICIENT
PROFIlight.

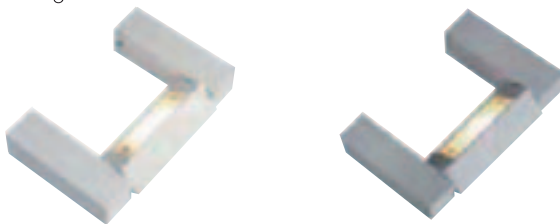

Socket/Bulb:
GU6,5/HIT-TC (excl.)
20W

Material:
Aluminium

Dimensions:
W/H/D: 24,3/4,1/15,2 cm

Accessory/Included parts:
Electronic ballast (incl.)

Versions:
white
silver grey

Art. No.:
157551
157554

Recommended bulb:
20W, 3000K, 1615lm
507020



SHELL HQI-TS Design by CDC

230~



HiEFFICIENT
PROFIlight.



Socket/Bulb:
Rx7s/HQI-TS; CDM-TS (excl.)
70/150W

Material:
Steel

Dimensions:
W/H/D: 22,5/6/22,5 cm

Accessory/Included parts:
Electronic ballast (incl.)

Note:
Can only be used as upright.

Versions:
70W
white
silver grey

Art. No.:
150331
150332

Versions:
150W
white
silver grey

Art. No.:
150631
150632

Recommended bulb:
70W, 4200K, 6500lm
509071



Recommended bulb:
150W, 4200K, 12500lm
509151





SHELL WL-1 TC-DE Design by CDC

230~

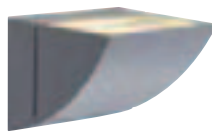
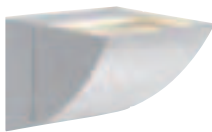

Socket/Bulb:
G24q-3/TC-DE EnergySaver (excl.)
26W

Versions:
white
silver grey

Art. No.:
150471
150474

Material:
Aluminium

Dimensions:
W/H/D: 22/15/16,5 cm

Recommended bulb:
26W, 3000K, 1800lm, EEK=B
508222

Accessory/Included parts:
Electronic ballast (incl.)



SHELL WL-2 Rx7s Design by CDC

230~

HiEFFICIENT
PROFILight.

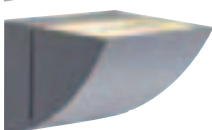
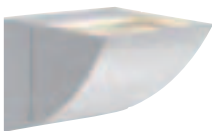

Socket/Bulb:
Rx7s/HQI-TS; CDM-TS (excl.)
70/150W

Material:
Aluminium

Dimensions:
W/H/D: 22/15/16,5 cm

Accessory/Included parts:
Electronic ballast (incl.)

Note:
Can only be used as uplight.

Versions:
70W
white
silver grey

Art. No.:
150481
150484

Versions:
150W
white
silver grey

Art. No.:
150491
150494

Recommended bulb:
70W, 4200K, 6500lm
509071



Recommended bulb:
150W, 4200K, 12500lm
509151



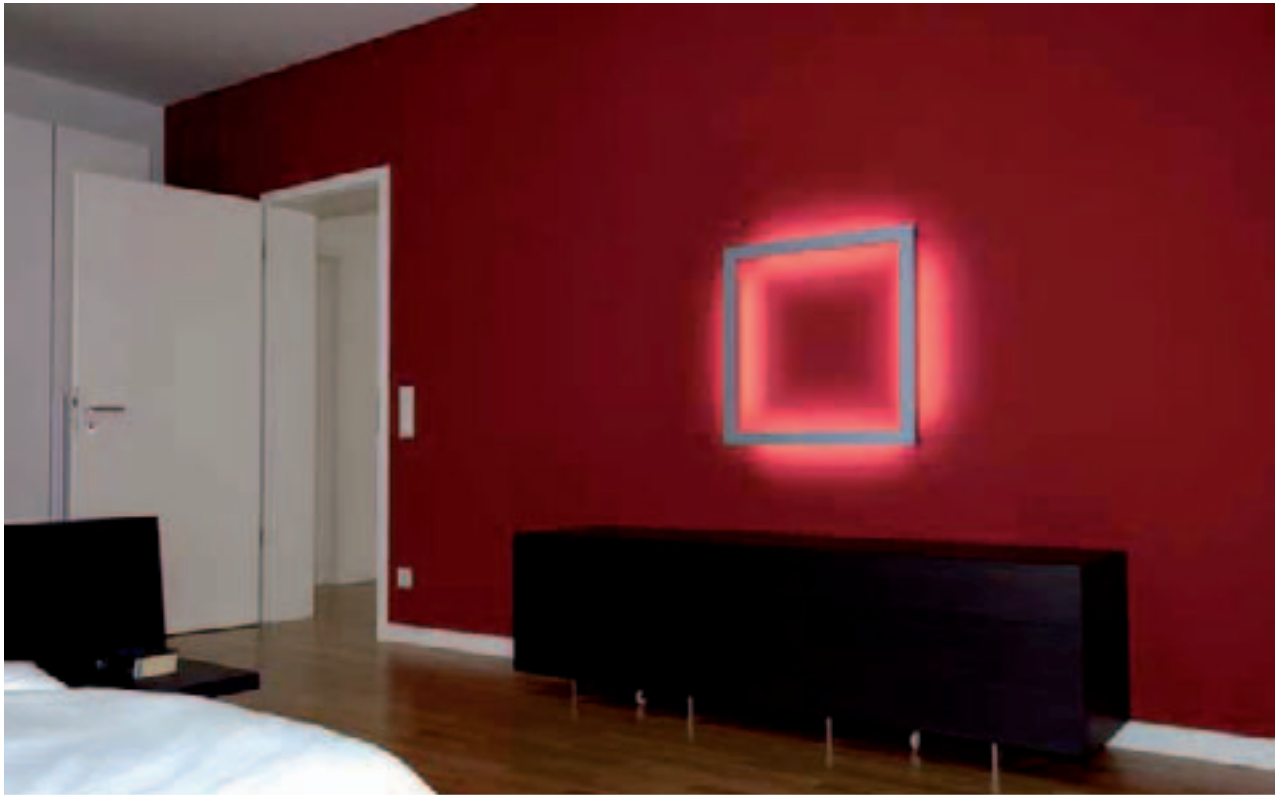

T5 GRILL UNI Design by CDC

230~



Series: Page 074



Socket/Bulb:
G5/T5 EnergySaver (excl.)
4x 24W

Material:
Aluminium/acrylic

Dimensions:
L/W/H: 60,5/60,5/6,5 cm
Wall distance: 1,6 cm

Accessory/Included parts:
Electronic ballast (incl.)

Version:
silver grey
Acrylic glass satined

Art. No.:
157092

Recommended bulb:
24W, 3000K, 1700lm
548024

(PU see page 661)



OPEN GRILL Design by CDC

230~



Series: Page 074

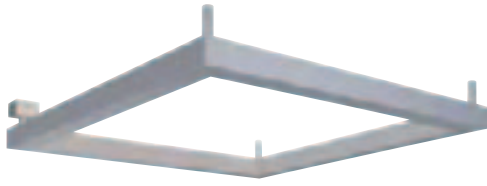

Socket/Bulb:
G5/T5 EnergySaver (excl.)
4x 24W

Version:
silver grey

Art. No.:
157384

Material:
Aluminium

Dimensions:
L/W/H: 68/68/10 cm
Canopy-L/W/H: 5/4,5/3 cm

Recommended bulb:
24W, 3000K, 1700lm
548024

(PU see page 661)

Accessory/Included parts:
Electronic ballast (incl.)

Note:
Canopy at one corner.



NEOPAN

230~



Socket/Bulb:
G10q/T8-Ring EnergySaver (excl.)
40W

Version:
white

Art. No.:
157371

Material:
PMMA

Dimensions:
L/W/H: 55/55/6,5 cm

Recommended bulb:
40W, 3000K, 3200lm, EEK=B
548210

Accessory/Included parts:
Electronic ballast (incl.)



NEODISC

230~



Socket/Bulb:
G10q/T8-Ring EnergySaver (excl.)
32W

Version:
alu brushed/chrome
Glass satined

Art. No.:
151656

Material:
Aluminium/glass

Dimensions:
L/W/H: 40/40/6,5 cm

Recommended bulb:
32W, 3000K, 2375lm, EEK=B
548230

Accessory/Included parts:
Low-loss ballast (incl.)

Note:
Chrome glass fastening.



XERXES CHROME

230~

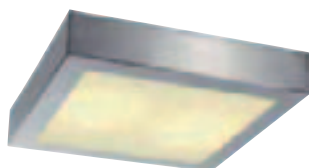

Socket/Bulb:
G24q-2/TC-DE EnergySaver (excl.)
2x 18W

Versions:
chrome
Glass satined

Art. No.:
15172

Material:
Steel/glass

Dimensions:
L/W/H: 30/30/6 cm

Recommended bulb:
18W, 3000K, 1200lm, EEK=B
508220

Accessory/Included parts:
Electronic ballast (incl.)





LED PANEL CL 136

24°



96 pce.

max.
1,5 mm²

120°



3,7



Series: Page 073

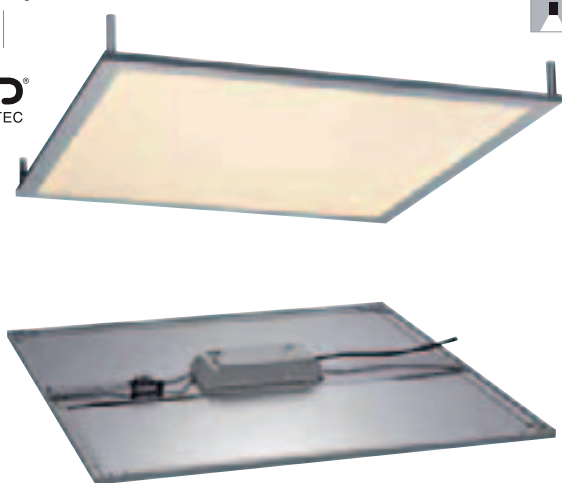

Bulb:
SMD LED
50W

Material:
Aluminium/acrylic

Dimensions:
L/W/H: 59,6/59,6/3,2 cm

Accessory/Included parts:
Power unit (excl.)
4 spacer L: 5 cm (incl.)

Note:
When connecting several lamps,
please pay attention to the total
wattage. Further power units can
be found in the accessory range.

Versions:
alu anodized, LED white
5500K, 2500lm
alu anodized, LED warm white
3000K, 2920lm

Art. No.:
158501
158502

For installation in grid ceilings:
Suitable for grid ceilings with
dimensions 60 x 60 cm.

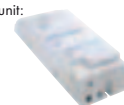
**For fitting in 62 x 62 cm
grid ceilings you need the
Grid lamp adapter 158110**
Recommended power unit:
Netzteil 60W, 24V=
470506

LED PANEL LONG CL 137

24°



96 pce.

max.
1,5 mm²

85°



3,3



Series: Page 073

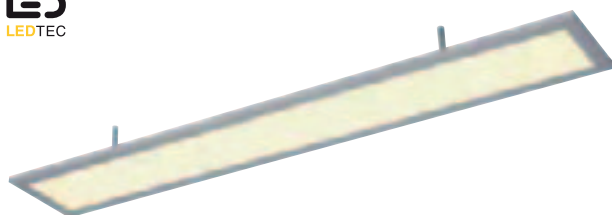

Bulb:
SMD LED
50W

Material:
Aluminium/acrylic

Dimensions:
L/W/H: 119,8/19,2/6,5 cm

Accessory/Included parts:
Power unit (excl.)
4 spacer L: 5 cm (incl.)

Note:
When connecting several lamps,
please pay attention to the total
wattage. Further power units can
be found in the accessory range.

Versions:
alu anodized, LED white
5500K, 2050lm
alu anodized, LED warm white
3000K, 1850lm

Art. No.:
158521
158522

Recommended power unit:
Power unit 60W, 24V=
470506









KUNO CEILING

230~

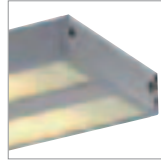
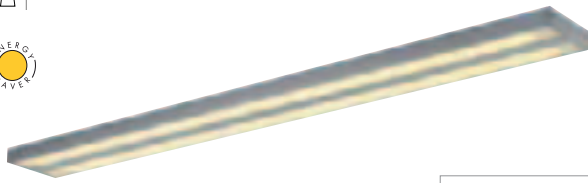

Series: Page 069



Socket/Bulb:
G5/T5 EnergySaver (excl.)
2x 54W

Material:
Aluminium/Diffuser made of PMMA

Dimensions:
L/W/H: 119/13,5/3 cm

Accessory/Included parts:
Electronic ballast (incl.)

Versions:
silver grey

Art. No.:
160774

Recommended bulb:
54W, 3000K, 5000lm
548054

(PU see page 661)



RIFFA CL-2

230~

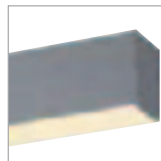
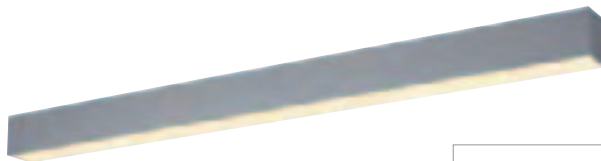

Socket/Bulb:
G5/T5 EnergySaver (excl.)
54W

Material:
Aluminium/Diffuser made of PMMA

Dimensions:
L/W/H: 120/7/8 cm

Accessory/Included parts:
Electronic ballast (incl.)

Versions:
silver grey

Art. No.:
158344

Recommended bulb:
54W, 3000K, 5000lm
548054

(PU see page 661)



RIFFA CL-1

230~



Series: Page 065

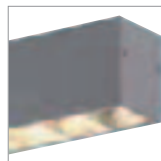
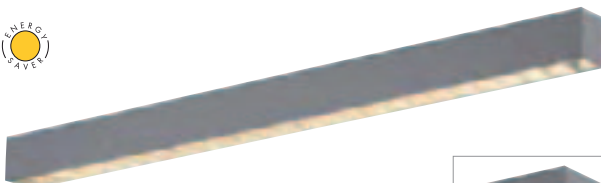

Socket/Bulb:
G5/T5 EnergySaver (excl.)
54W

Material:
Aluminium

Dimensions:
L/W/H: 120/7/8 cm

Accessory/Included parts:
Electronic ballast (incl.)

Note:
Dark-Light grid with DIN 5035-7
standard for display work station.

Versions:
silver grey

Art. No.:
158334

Recommended bulb:
54W, 3000K, 5000lm
548054

(PU see page 661)





LONG GRILL CEILING

Series: Page 063

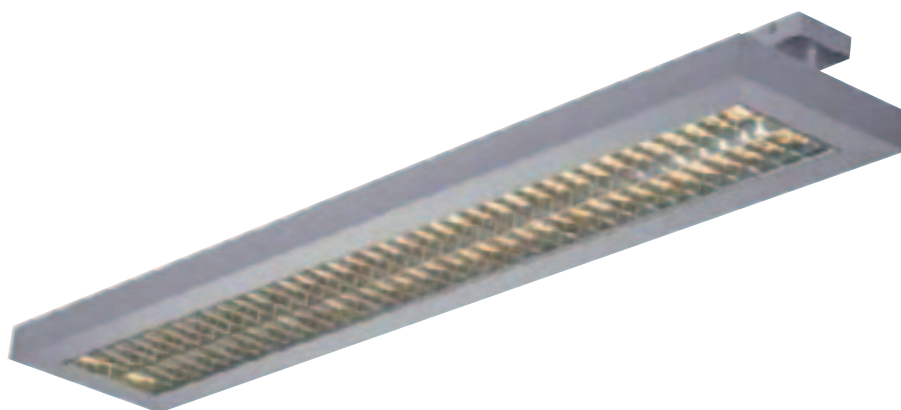

LONG GRILL CEILING



230~



Socket/Bulb:
G5/T5 EnergySaver (excl.)
2x 54W

Versions:
silver grey

Art. No.:
157534

Material:
Aluminium

Dimensions:
L/W/H: 126/23/10,5 cm
Canopy-L/W/H: 7,5/7,5/2,5 cm

Recommended bulb:
54W, 3000K, 5000lm
548054

(PU see page 661)

Accessory/Included parts:
Electronic ballast (incl.)
Canopy (incl.)

Note:
Ceiling luminaire with Dark-Light
grid, suitable for display work
stations.

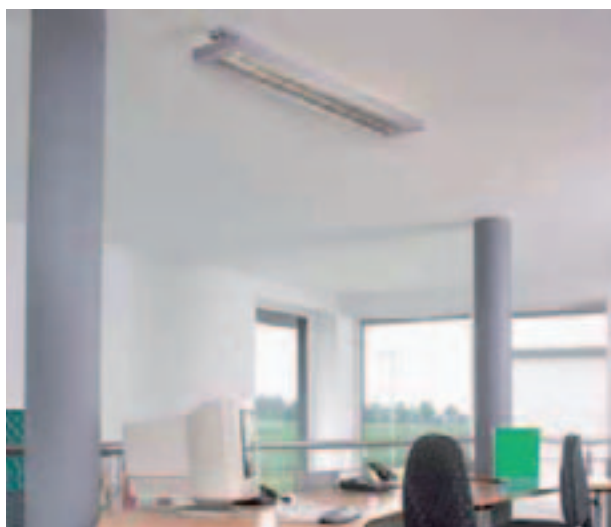



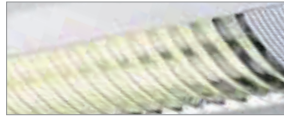

Tristan T8 lamps are equipped with a chrome plated grid and high-polish reflector for a downwards emitted, glare-free light.

TRISTAN T8 18W

230~



Socket/Bulb:
G13/T8 EnergySaver (excl.)
2x 18W

Material:
Steel

Dimensions:
L/W/H: 70,5/18,5/6 cm

Accessory/Included parts:
Low-loss ballast (incl.)

Versions:
white

Art. No.:
160841

Recommended bulb:
18W, 3000K, 1350lm
548202

(PU see page 661)



TRISTAN T8 36W

230~



Socket/Bulb:
G13/T8 EnergySaver (excl.)
2x 36W

Material:
Steel

Dimensions:
L/W/H: 131,5/18,5/6 cm

Accessory/Included parts:
Low-loss ballast (incl.)

Versions:
white
silver grey

Art. No.:
160761
160764

TRISTAN T8 58W

230~



Socket/Bulb:
G13/T8 EnergySaver (excl.)
2x 58W

Material:
Steel

Dimensions:
L/W/H: 161/18,5/6 cm

Accessory/Included parts:
Electronic ballast (incl.)

Versions:
white
silver grey

Art. No.:
160861
160864



TC GRID 218

white 160771

Material: Steel/grid aluminium
Included parts: Low-loss ballast (incl.)

Recommended bulb:
18W, 2700K, 1200lm, EEK=A
508460



TC GRID 336

white 160781

Material: Steel/grid aluminium
Included parts: Low-loss ballast (incl.)

Recommended bulb:
36W, 2700K, 2900lm, EEK=A
590144



TC INDI 255

white 160791

Material: Steel
Included parts: Electronic ballast (incl.)
Note: Indirect light emission

Recommended bulb:
55W, 2700K, 4800lm, EEK=A
508450

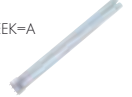

TC GRID 218, TC GRID 336, TC INDI 255

230~



Article No.	Description	Colour	Voltage in AC	Socket/ Bulb (excl.)	Wattage Bulb	Energy efficiency category ballast	Length in cm	Width in cm	Height in cm	Weight in kg	Price
160771	TC grid 218	white	230V	2G11/TC-L EnergySaver	2x 18W	EEI=B2	30,5	30,5	7,0	1,60	
160781	TC grid 336	white	230V	2G11/TC-L EnergySaver	3x 36W	EEI=B2	50,0	50,0	7,0	4,10	
160791	TC Indi 255	white	230V	2G11/TC-L EnergySaver	2x 55W	EEI=A2	58,5	55,0	6,5	4,65	

The lamps TC Grid 218 and 336 are equipped with high-polish reflector for a downwards emitted, glare-free light.



STAGE FACTORY LINE®



GU10, 50W max. | 156632 |



ES111, 75W max. | 156722 |

SFL® PAR20 G



Material:
Aluminium

Recommended bulb:
50W, 50°, 2700K, 580cd
575510



Dimensions:
Mains cable-L: 30 cm

Included parts:
Protective contact plug (incl.)

Recommended bulb:
 LEDspot 4W
36°, 3000K, 300cd, 165lm
560084



Accessory:
see page 227

SFL® PAR36 ES111



Material:
Aluminium

Recommended bulb:
75W, 24°, 2700K, 2000cd
575672



Dimensions:
Mains cable-L: 100 cm

Included parts:
Protective contact plug (incl.)

Recommended bulb:
PowerLED 10W, 25°, 580lm
550341 5500K



Accessory:
see page 227

SFL® PAR 20 / 36

230~



350°



180°



← ↑

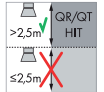
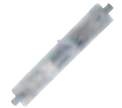
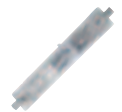

Article No.	Description	Colour	Voltage in AC	Socket/Bulb (excl.)	Wattage Bulb	Length in cm	Width in cm	Height in cm	Gewicht in kg	Protection class	Price
156632	SFL® PAR20 G	alu	230V	GU10/GU10	50W max.	16,6	8,2	8,2	0,3	I	
156722	SFL® PAR36 ES111	alu	230V	GU10/ES111	75W max.	22,0	16,2	16,2	0,7	II	

**HiEFFICIENT**
PROFIlight.HQI-T, 70W | 156662 |
HQI-T, 150W | 156672 |**HiEFFICIENT**
PROFIlight.HQI-TS, CDM-TS, 70W | 156682 |
HQI-TS, CDM-TS, 150W | 156692 |**SFL® PAR56 T 70 / 150 LONG HV G12****Material:**
Aluminium**Dimensions:**
Mains cable-L: 100 cm**Accessory/Included parts:**
Protective contact plug (incl.)
Ballast (incl.)**Note:**
Lamp is not suitable for colour foils!**Recommended bulb:**
70W
507130 3000K, 6600lm
507131 4200K, 12700lm**Recommended bulb:**
150W
507140 3000K, 14000lm
507141 4200K, 12700lm**SFL® PAR56 TS 70 / 150 LONG HV R7s****Material:**
Aluminium**Dimensions:**
Mains cable-L: 100 cm**Accessory/Included parts:**
Protective contact plug (incl.)
Conventional ballast (incl.)**Note:**
Lamp is not suitable for colour foils!**Recommended bulb:**
70W, 4200K, 6500lm
509071**Recommended bulb:**
150W, 4200K, 12500lm
509151**SFL® PAR56 T/TS Professional lamps for commercial use**

230~

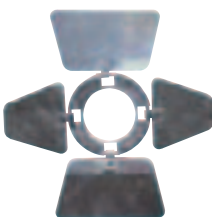

Article No.	Description	Voltage in AC	Colour	Socket/Bulb (excl.)	Wattage Bulb	Length in cm	Width in cm	Height in cm	Rotation/Swivel range	Weight in kg	Price
156662	SFL® PAR T 70 Long HV G12	230V	alu	G12/HQI-T	70W	40,5	22,8	22,8	350°/180°	3,5	
156672	SFL® PAR T 150 Long HV G12	230V	alu	G12/HQI-T	150W	40,5	22,8	22,8	350°/180°	4,5	
156682	SFL® PAR TS 70 Long HV R7s	230V	alu	R7s/HQI-TS;CDM-TS	70W	40,5	22,8	22,8	350°/180°	3,5	
156692	SFL® PAR TS 150 Long HV R7s	230V	alu	R7s/HQI-TS;CDM-TS	150W	40,5	22,8	22,8	350°/180°	4,5	

ACCESSORY for SFL® PAR 20 / 36 / 56**Shutters**
for SFL® PAR20
L/W/H: 21,5/21,5/1 cmArt. No.:
156812for SFL® PAR36
L/W/H: 47/47/2 cm

156822

for SFL® PAR56
L/W/H: 58/58/2 cm



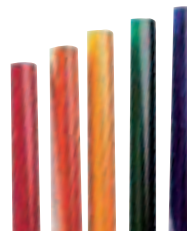













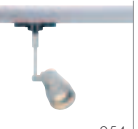





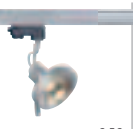





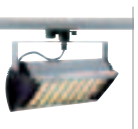

156832

**SFL® colour foils**
yellow
green
red
blue
orange
L/W: 75/50 cmArt. No.:
156914
156915
156916
156917
156919For SFL® PAR flood light up to max. 500W.
Not suitable for flood lights with HIT/HIT-TS/HQI-T bulbs!**SFL® CHook**
for SFL® PAR20, 1pce.
Clamping range: 3,5 cm max.Art. No.:
156902for SFL® PAR36/56, 1pce.
Clamping range: 5 cm max.

156912

3PHASE TRACK SYSTEM

Our 3Phase spotlights are compatible to 3Phase systems of other leading manufactures. All lamps are equipped with a 3Phase-adaptor or 3Phase pendant-adaptor.

Spotlights for low-voltage bulb MR16	 <p>239</p>	 <p>250</p>					
Spotlights for low-voltage bulb QRB111	 <p>236</p>	 <p>250</p>	 <p>250</p>				
Spotlights for high-voltage bulb GU10	 <p>239</p>	 <p>249</p>	 <p>250</p>	 <p>254</p>	 <p>254</p>	 <p>254</p>	 <p>255</p>
Spotlights for high-voltage bulb ES111	 <p>236</p>	 <p>253</p>	 <p>252</p>	 <p>252</p>	 <p>252</p>		
Spotlights for high-voltage bulb R7s	 <p>248</p>	 <p>248</p>	 <p>248</p>				
Spotlights for high-voltage bulb PAR	 <p>252</p>	 <p>249</p>					
Spotlights for energy-saving bulb	 <p>239</p>	 <p>253</p>	 <p>256</p>	 <p>256</p>	 <p>256</p>	 <p>256</p>	
Professional spots for the commercial use PROFILIGHT	 <p>235</p>	 <p>235</p>	 <p>244</p>	 <p>244</p>	 <p>247</p>	 <p>247</p>	
	 <p>247</p>	 <p>241</p>	 <p>242</p>	 <p>242</p>	 <p>242</p>		
LED spotlights LED	 <p>229</p>	 <p>230</p>	 <p>230</p>	 <p>233</p>	 <p>233</p>		
Accessory for 3Phase track system A+	<p>257-259</p>						



TRACK SPOT

Spotlight system for 3Phase track system

LED TRACKSPOT 3



Bulb: PowerLED (incl.) 3x 3W	Versions: 3000K, 410lm black 10° 152500 white 10° 152501 silver grey 10° 152504	Art. No.:
Material: Aluminium/plastic	black 30° 152510 white 30° 152511 silver grey 30° 152514	
Dimensions: L/W/H: 9/7,3/17,5 cm		
Accessory/Included parts: LED driver (incl.)		

LED TRACKSPOT 12



Bulb: PowerLED (incl.) 12x 1,2W	Versions: 3000K, 900lm black 10° 152520 white 10° 152521 silver grey 10° 152524	Art. No.:
Material: Aluminium/plastic	black 30° 152530 white 30° 152531 silver grey 30° 152534	
Dimensions: L/W/H: 14/11/24 cm		
Accessory/Included parts: LED driver (incl.)		



DOMELED

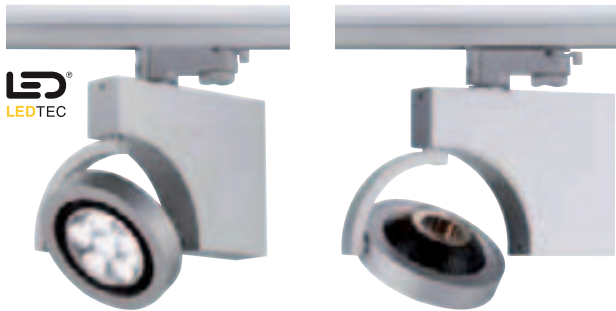
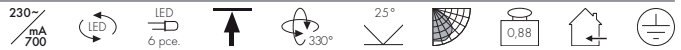

Bulb:
PowerLED (incl.)
6x 3W

Material:
Aluminium/plastic

Dimensions:
W/H/D: 22/18,5/3,8 cm

Accessory/Included parts:
LED driver (incl.)

Versions:
silver grey
LED 6000K, 920lm
LED 3000K, 670lm

Art. No.:
153501
153502

3PH 102 LED



Bulb:
PlanarLED (incl.)
10W

Material:
Aluminium

Dimensions:
W/H/D: 11,5/13/9 cm

Accessory/Included parts:
LED driver (incl.)

Versions:
silver grey
LED white, 610lm
LED warm white, 550lm

Art. No.:
153601
153602







EURO SPOT

Spotlight series for 3Phase track system

EURO SPOT INTEGRATED LED



Bulb: PHILIPS Fortimo Integrated Spot (incl.)	Material: Aluminium	Dimensions: Head-Ø: 8 cm L/H: 15/18,5 cm	Versions: 2700K, 13W, 600lm, Ra80	Art. No.:
			black	15° 153900
			white	15° 153901
			silver grey	15° 153904
			black	24° 153910
			white	24° 153911
			silver grey	24° 153914
			black	36° 153920
			white	36° 153921
			silver grey	36° 153924

Versions: 3000K, 13W, 640lm, Ra80	Art. No.:	Versions: 4000K, 13W, 640lm, Ra80	Art. No.:
black	15° 153930	black	15° 153960
white	15° 153931	white	15° 153961
silver grey	15° 153934	silver grey	15° 153964
black	24° 153940	black	24° 153970
white	24° 153941	white	24° 153971
silver grey	24° 153944	silver grey	24° 153974
black	36° 153950	black	36° 153980
white	36° 153951	white	36° 153981
silver grey	36° 153954	silver grey	36° 153984

EURO SPOT LED DISK 800



Bulb: PHILIPS Fortimo LED Disk Module (incl.)	Material: Aluminium	Dimensions: Head-Ø/L: 12,5/14 cm L/H: 14/22 cm	Versions: 2700K, 14,5W, 800lm, Ra90	Art. No.:
			LED warm white	
			black	153490
			white	153491
			silver grey	153494
			4000K, 15,2W, 850lm, Ra80	
			LED warm white	
			black	153990
			white	153991
			silver grey	153994



HiEFFICIENT
PROFIlight.

 Euro Spot
 electronic ballast

 Euro Spot
 electronic ballast

EURO SPOT ELECTRONIC BALLAST

230~

Socket/Bulb:
 G12/HQI-T; CDM-T (excl.)
 35/50/70W

Material:
 Aluminium/glass

Dimensions:
 L/H: 30,5/30 cm
 Head-Ø/L: 12,5/30 cm

Accessory/Included parts:
 Reflector (incl.)

Versions:
 matt-black, 35W
 Angle of radiation 15°
 Angle of radiation 60°

Art. No.:
 153860
 153870

 white, 35W
 Angle of radiation 15°
 Angle of radiation 60°

Art. No.:
 153861
 153871

 silver grey, 35W
 Angle of radiation 15°
 Angle of radiation 60°

Art. No.:
 153864
 153874

Versions:
 matt-black, 50W
 Angle of radiation 60°

Art. No.:
 153840

 white, 50W
 Angle of radiation 60°

Art. No.:
 153841

 silver grey, 50W
 Angle of radiation 60°

Art. No.:
 153844

Versions:
 matt-black, 70W
 Angle of radiation 15°
 Angle of radiation 60°

Art. No.:
 153880
 153890

 white, 70W
 Angle of radiation 15°
 Angle of radiation 60°

Art. No.:
 153881
 153891

 silver grey, 70W
 Angle of radiation 15°
 Angle of radiation 60°

Art. No.:
 153884
 153894

Recommended bulb:
 35W, 4200K, 3300lm, Ra90
 507121

Recommended bulb:
 50W, 3000K, 5400lm, Ra90
 507450

Recommended bulb:
 70W, 4200K, 6600lm
 507131

EURO SPOT G 12

230~

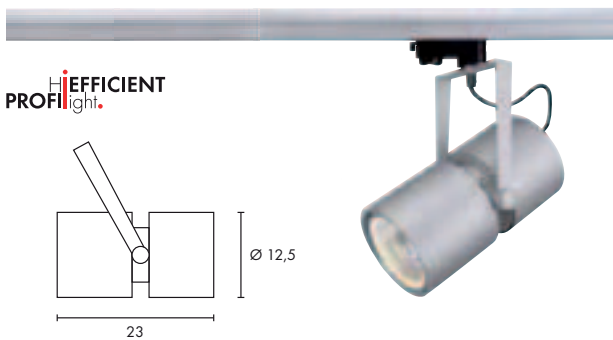
HiEFFICIENT
PROFIlight.

Socket/Bulb:
 G12/HQI-T; CDM-T (excl.)
 70W

Material:
 Aluminium

Dimensions:
 L/W: 32/16,5 cm
 Head-Ø/L: 12,5/23 cm

Accessory/Included parts:
 Conventional ballast (incl.)

Versions:
 matt-black
 Angle of radiation 15°
 Angle of radiation 60°

Art. No.:
 153400
 153410

 white
 Angle of radiation 15°
 Angle of radiation 60°

Art. No.:
 153401
 153411

 silver grey
 Angle of radiation 15°
 Angle of radiation 60°

Art. No.:
 153404
 153414

Recommended bulb:
 70W, 6600lm
 507130 3000K
 507131 4200K



EURO SPOT QRB111

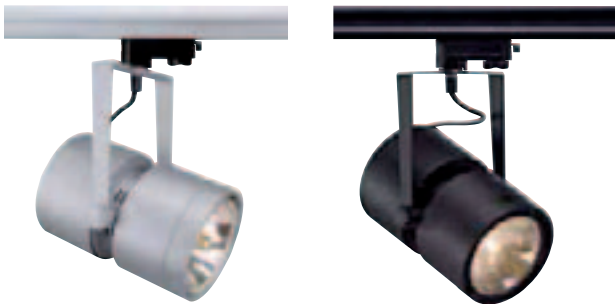

Socket/Bulb:
G53/QRB111 (excl.)
75W max.

Material:
Aluminium

Dimensions:
L/W: 28/16,5 cm
Head-Ø/L: 12,5/20 cm

Accessory/Included parts:
Conventional transformer (incl.)

Versions:
matt-black
white
silver grey

Art. No.:
153430
153431
153434

Recommended bulb:
50W EnergySaver \neq 75W
3000K
545752 24°, 5800cd
545753 40°, 2000cd



EURO SPOT ES111

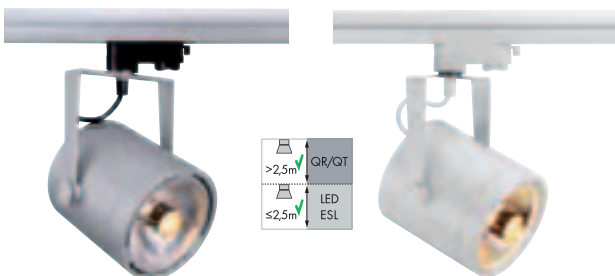

Socket/Bulb:
GU10/ES111 (excl.)
75W max.

Material:
Aluminium

Dimensions:
L/W: 24/16,5 cm
Head-Ø/L: 12,5/14,5 cm

Versions:
white
silver grey

Art. No.:
153421
153424

Recommended bulb:
75W, 24°, 2700K, 2000cd
575672







EURO SPOT GU10

230~



Socket/Bulb:
 GU10/GU10 (excl.)
 50W max.

Material:
 Aluminium

Dimensions:
 L/H: 12,3/17,2 cm
 Head-Ø/L: 8/12,3 cm

Versions:
 black
 white
 silver grey

Art. No.:
 153850
 153851
 153854

Recommended bulb:
 35W EnergySaver ≅ 50W
 20°, 2800K, 1200cd
 575370

EURO SPOT MR16

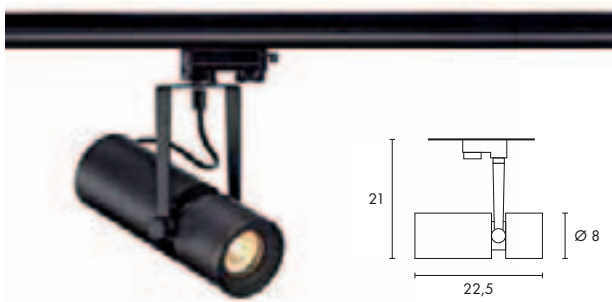
 230~
12~

Socket/Bulb:
 GU5,3/MR16 (excl.)
 50W max.

Material:
 Aluminium

Accessory/Included parts:
 Electronic transformer (incl.)

Versions:
 black
 white
 silver grey

Art. No.:
 153480
 153481
 153484

Recommended bulb:
 Precise™ Constantcolor™
 50W, 40°, 3050K, 1500cd
 525540

EURO SPOT E27

230~



Socket/Bulb:
 E27/EnergySaver (excl.)
 up to max. Ø/L: 6/17,5 cm

Material:
 Aluminium

Dimensions:
 L/W: 32/16,5 cm
 Head-Ø/L: 12,5/23 cm

Versions:
 white
 silver grey

Art. No.:
 153461
 153464

Recommended bulb:
 23W, 2700K, 1350lm, EEK=A
 508970





SLEEK SPOT

Spotlight system for 3Phase track system



SLEEK SPOT G 12

230~



PROFIl
light.

Socket/Bulb:
G12/HQI-T, CDM-T (excl.)
70W

Material:
Aluminium/steel

Dimensions:
L/W/H: 20,5/16,8/13,5 cm

Accessory/Included parts:
Electronic ballast (incl.)
Reflector (incl.)
Deco ring (excl.)

Versions:	Art. No.:
black	
12°	153640
24°	153650
48°	153660
white	
12°	153641
24°	153651
48°	153661
silver grey	
12°	153644
24°	153654
48°	153664

Select your colour version with the desired angle of radiation. Suitable deco rings can be found in the accessory list on the left below. In case you want to change the angle of radiation later on, the corresponding reflectors are available separately (see list on the right below).

Recommended bulb:
70W, 6600lm
507130, 3000K
507131, 4200K



ACCESSORY for Sleek Spot G12



Deco ring	Art. No.:
black	153670
white	153671
silver grey	153674
chrome	153672

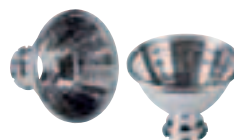

Reflector	Art. No.:
Aluminium	12° 153681
Ø/H: 11/8 cm	24° 153682
	48° 153684

D-RECTION 35W, GU6,5 Design by CDC

230~

HiEFFICIENT
PROFIlight.

Reflectors with various angles of radiation see below.

Socket/Bulb:
 GU6,5/CMH-TC (excl.)
 35W

Material:
 Aluminium

Dimensions:
 L/W/H: 24/9,5/19 cm

Accessory/Included parts:
 Electronic ballast (incl.)
 Deco ring (incl.)
 Reflector (excl.)

Versions:
 black/chrome
 white
 silver grey

Art. No.:
 153710
 153711
 153714

chrome

153712

Recommended bulb:
 35W, 4200K, 3400lm, Ra90
 507031

D-RECTION 70W, G12 Design by CDC

230~

HiEFFICIENT
PROFIlight.

Reflectors with various angles of radiation see below.

Socket/Bulb:
 G12/CDM-T (excl.)
 70W

Material:
 Aluminium

Dimensions:
 L/W/H: 26/9,5/22 cm

Accessory/Included parts:
 Electronic ballast (incl.)
 Deco ring (incl.)
 Reflector (excl.)

Versions:
 black/chrome
 white
 silver grey

Art. No.:
 153730
 153731
 153734

Recommended bulb:
 70W, 3000K, 6600lm
 507130

Recommended bulb:
 70W, 3000K, 7750lm
 507430

D-RECTION ELITE 50W, G12 Design by CDC

230~

HiEFFICIENT
PROFIlight.

Reflectors with various angles of radiation see below.

Socket/Bulb:
 G12/CDM-T (excl.)
 50W

Material:
 Aluminium/glass

Dimensions:
 L/W/H: 24/9,5/15 cm

Accessory/Included parts:
 Electronic ballast (incl.)
 Deco ring (incl.)
 Reflector (excl.)

Versions:
 white
 silver grey

Art. No.:
 153761
 153764

chrome

153762

Recommended bulb:
 50W, 3000K, 5400lm, Ra90
 507450

ACCESSORY for Spots

Reflector for D-rection 35W, GU6,5	Art. No.:
Aluminium, chrome	12° 153721
Ø/H: 9,5/8 cm	24° 153722
	38° 153723
	60° 153726



Reflector for D-rection 70W and D-rection Elite 50W, G12	Art. No.:
Aluminium	12° 153741
Ø/H: 11/9 cm	24° 153742
	38° 153743
	60° 153746





PROFIL **HiEFFICIENT**
light.



SDL 70

Design by CDC

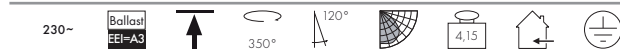

Socket/Bulb:
Rx7s/HQI-TS; CDM-TS (excl.)
70W

Versions:
white
silver grey

Art. No.:
150551
150552

Material:
Aluminium

Dimensions:
L/W/H: 39/25/10 cm

Recommended bulb:
70W, 4200K, 6500lm
509071



Accessory/Included parts:
Conventional ballast (incl.)

Recommended accessory:
Shutters L/W/H: 38/27,5/3,5 cm
150571 white
150572 silver grey

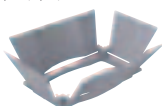

PROFIL **HiEFFICIENT**
light.



SDL 150

Design by CDC

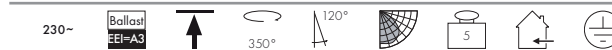

Socket/Bulb:
Rx7s/HQI-TS; CDM-TS (excl.)
150W

Versions:
white
silver grey

Art. No.:
150561
150562

Material:
Aluminium

Dimensions:
L/W/H: 39/25/10 cm

Recommended bulb:
150W, 4200K, 12500lm
509151



Accessory/Included parts:
Conventional ballast (incl.)

Recommended accessory:
Shutters L/W/H: 38/27,5/3,5 cm
150571 white
150572 silver grey

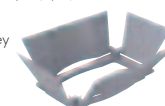

PROFIL **HiEFFICIENT**
light.



SDL PRO 70

Design by CDC

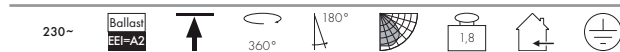

Socket/Bulb:
Rx7s/HQI-TS; CDM-TS (excl.)
70W

Versions:
white
silver grey

Art. No.:
153621
153624

Material:
Aluminium

Dimensions:
L/W/H: 30/27/8 cm
BracketH: 16 cm

Recommended bulb:
70W, 4200K, 6500lm
509071



Accessory/Included parts:
Electronic ballast (incl.)



PROFIL **HiEFFICIENT**
light.



SDL PRO 150

Design by CDC

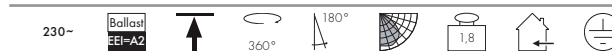

Socket/Bulb:
Rx7s/HQI-TS; CDM-TS (excl.)
150W

Versions:
white
silver grey

Art. No.:
153631
153634

Material:
Aluminium

Dimensions:
L/W/H: 30/27/8 cm
BracketH: 16 cm

Recommended bulb:
150W, 4200K, 12500lm
509151



Accessory/Included parts:
Electronic ballast (incl.)





HQI-TS FLOOD 70

230~

Socket/Bulb:
 Rx7s/HQI-TS; CDM-TS (excl.)
 70W

Material:
 Steel

Dimensions:
 L/W/H: 20/20/10 cm

Accessory/Included parts:
 Conventional ballast (incl.)

Versions:
 Bracket, open cable end
 white
 silver grey

Art. No.:
 150301
 150302

Versions:
 3Ph-adapter (incl.)
 white
 silver grey

Art. No.:
 150321
 150322

Ceiling canopy (incl.)
 white
 silver grey
 150311
 150312

Recommended bulb:
 70W, 4200K, 6500lm
 509071

HQI-TS FLOOD 150

230~

Socket/Bulb:
 Rx7s/HQI-TS; CDM-TS (excl.)
 150W

Material:
 Steel

Dimensions:
 L/W/H: 24/24/10 cm

Accessory/Included parts:
 Conventional ballast (incl.)

Versions:
 Bracket, open cable end
 white
 silver grey

Art. No.:
 150601
 150602

Versions:
 3Ph-adapter (incl.)
 white
 silver grey

Art. No.:
 150621
 150622

Ceiling canopy (incl.)
 white
 silver grey
 150611
 150612

Recommended bulb:
 150W, 4200K, 12500lm
 509151

Q-TECH® G12 HOR

230~

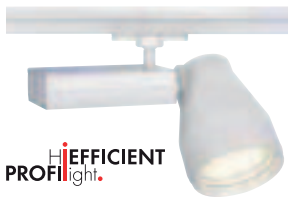
Socket/Bulb:
 G12/HQI-T; CDM-T (excl.)
 70W

Material:
 Aluminium

Dimensions:
 Head-Ø: 12 cm
 W/H 30,5/16 cm

Accessory/Included parts:
 Electronic ballast (incl.)
 Reflector (excl.)

Note:
 Reflector see below.

Versions:
 white ▼
 silver grey ▼

Art. No.:
 153201
 153204

Recommended bulb:
 70W
 507130 3000K, 6600lm
 507131 4200K, 12700lm

NAVIGATOR® G8,5

230~

Socket/Bulb:
 G8,5/CDM-TC (excl.)
 70W

Material:
 Aluminium

Dimensions:
 L/W/H: 37,5/14/21,5 cm

Accessory/Included parts:
 Electronic ballast (incl.)
 Reflector (excl.)

Note:
 Reflector see below.

Versions:
 silver grey ▼

Art. No.:
 153164

Recommended bulb:
 70W, 4200K, 6200lm
 507047

ACCESSORY for Q-Tech® G12 and Navigator® G8,5

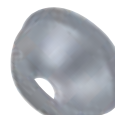
Reflector for Q-Tech® G12 Art. No.:
 Aluminium 24° ▼ 153241
 ProductØ: 10,5 cm 44° ▼ 153244
 60° ▼ 153246

Reflector for Navigator® G8,5 Art. No.:
 Aluminium 12° ▼ 153171
 ProductØ: 10,5 cm 24° ▼ 153172
 44° ▼ 153174
 60° ▼ 153176



SKELETTO

230~



Series: Page 318



Socket/Bulb:
R7s/R7s, 78 mm (excl.)
150W max.

Versions:
silver grey

Art. No.:
152404

Material:
Steel

Dimensions:
L/W/H: 17/15,5/5 cm

Recommended bulb:
100W EnergySaver \approx 150W
2700K, 1900lm, EEC=C
519215



NEPRO 2 R7s

230~

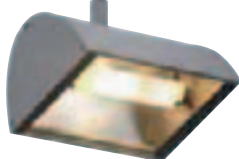

Socket/Bulb:
R7s/R7s, 118 mm (excl.)
150W max.

Versions:
silver grey

Art. No.:
153534

Material:
Aluminium

Dimensions:
L/W/H: 17/11,5/18,5 cm

Recommended bulb:
100W EnergySaver \approx 150W
2700K, 1900lm, EEC=C
519221



R7s SHOP

230~



Socket/Bulb:
R7s/R7s, 118 mm (excl.)
300W max.

Versions:
white
silver grey

Art. No.:
152301
152304

Material:
Aluminium/steel

Dimensions:
L/W/H: 18,5/27,5/14 cm

Accessory/Included parts:
Shutters (excl.)

Recommended bulb:
200W EnergySaver \approx 300W
2700K, 4000lm, EEC=C
519223



Recommended accessory:
Shutters L/W/H: 28,5/26/2 cm
(Dimensions refer to folded out shutters)
152311 white
152314 silver grey

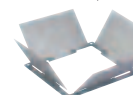



PAR MESH 16

alu 152154

Material: Aluminium

Recommended bulb:
35W EnergySaver \approx 50W
20°, 2800K, 1200cd
575370



PAR MESH 20

alu 152164

Material: Aluminium

Recommended bulb:
75W, 24°, 5500cd
519727



PAR MESH 30

alu 152174

Material: Aluminium

Recommended bulb:
150W, 24°, 11000cd
519739



PAR MESH Further shoplights can be found under "Stage Factory Line" on pages 226-227.

230~



Article No.	Description	Colour	Voltage in AC	Socket/Bulb (excl.)	Wattage Bulb	Ø in cm	Length in cm	Rotation/Swivel range	Operating range	Weight in kg	Price
152154	PAR Mesh 16	alu	230V	GU10/GU10	50W max.	9,0	24,0	350°/170°	Wall, Ceiling	0,11	
152164	PAR Mesh 20	alu	230V	E27/PAR20	75W max.	16,0	27,0	350°/170°	Wall, Ceiling	0,55	
152174	PAR Mesh 30	alu	230V	E27/PAR30	150W max.	18,0	39,0	350°/170°	Ceiling	0,68	



KARDATRACK MR16/2

silver grey 154502

Material: Aluminium
Accessory/Included parts:
Electronic transformer (incl.)

Recommended bulb:
50W, 25°, 2700K, 2450cd
535527



KARDATRACK GU10/4

silver grey 154532

Material: Aluminium

Recommended bulb:
35W EnergySaver ≈ 50W
20°, 2800K, 1200cd
575370



KARDATRACK QRB111/4

silver grey 154512

Material: Aluminium
Accessory/Included parts:
Electronic transformer (incl.)

Recommended bulb:
50W EnergySaver ≈ 75W
24°, 3000K, 5800cd
545572



KARDATRACK Design by CDC



Article No.	Description	Colour	Voltage in AC	Socket/Bulb (excl.)	Wattage Bulb	Length in cm	Width in cm	Height in cm	Rotation/Swivel range	Weight in kg	Price
154502	Kardatrack MR16/2	silver grey	230V/12V	GU5,3/MR16	2x 50W max.	35,0	13,0	15,0	350°/85°	0,95	
154532	Kardatrack GU10/4	silver grey	230V	GU10/GU10	4x 50W max.	52,5	13,0	18,0	-/180°	1,80	
154512	Kardatrack QRB111/4	silver grey	230V/12V	G53/QRB111	4x 50W max.	86,5	19,0	18,0	-/180°	2,60	



TEC 1 QRB

silver grey 153002

Material: Aluminium
Accessory/Included parts:
Electronic transformer (incl.)

Recommended bulb:
35W EnergySaver ≈ 50W
24°, 3000K, 4500cd
545522



TEC 2 QRB

silver grey 153012

Material: Aluminium
Accessory/Included parts:
Electronic transformer (incl.)

Recommended bulb:
35W EnergySaver ≈ 50W
24°, 3000K, 4500cd
545522



TEC 4 QRB

silver grey 153022

Material: Aluminium
Accessory/Included parts:
Electronic transformer (incl.)

Recommended bulb:
35W EnergySaver ≈ 50W
24°, 3000K, 4500cd
545522



TEC



Article No.	Description	Colour	Voltage in AC	Socket/Bulb (excl.)	Wattage Bulb	Length in cm	Width in cm	Height in cm	Weight in kg	Price
153002	TEC 1 QRB	silver grey	230V AC/12V AC	G53/QRB111	50W max.	14,0	18,0	19,5	0,70	
153012	TEC 2 QRB	silver grey	230V AC/12V AC	G53/QRB111	2x 50W max.	14,0	31,5	19,5	0,90	
153022	TEC 4 QRB	silver grey	230V AC/12V AC	G53/QRB111	4x 50W max.	30,5	31,5	19,5	1,50	



AERO PAR30 Design by CDC

230~



Socket/Bulb:
E27/PAR30 (excl.)
75W max.

Material:
Aluminium/plastic

Dimensions:
L/W/H: 12/12/15 cm

Versions:
silver grey

Art. No.:
152417

Recommended bulb:
75W, 24°, 7000cd
519737

YOKI ES111 Design by CDC/FGL

230~



Socket/Bulb:
GU10/ES111 (excl.)
75W max.

Material:
Aluminium

Dimensions:
L/W/H: 8,5/5/25,5 cm

Accessory/Included parts:
Deco ring (incl.)

Note:
Without deco ring, the spot can be used with the DomeLED ES111 bulb.

Versions:
silver grey

Art. No.:
153154

Recommended bulb:
75W, 24°, 2700K, 2000cd
575672



Recommended bulb:
PowerLED 10W, 40°, 460lm
550352 warm white

LUNA 1

230~

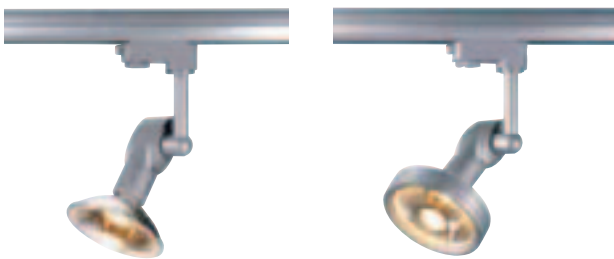

Socket/Bulb:
GU10/ES111 (excl.)
75W max.

Material:
Aluminium

Dimensions:
W/H 13/25,5 cm

Accessory/Included parts:
Deco ring (excl.)

Versions:
silver grey

Art. No.:
152282

Recommended bulb:
75W, 24°, 2700K, 2000cd
575672



Recommended accessory:
Deco ring 111
Not suitable for DomeLED.
151051

LIGHT EYE SPOT

230~



Series: Page 047, 165



Socket/Bulb:
GU10/ES111 (excl.)
75W max.

Material:
Steel

Dimensions:
Ø/H: 15/28 cm

Versions:
chrome

Art. No.:
153102

Recommended bulb:
75W, 24°, 2700K, 2000cd
575672



Recommended bulb:
PowerLED 10W, 40°, 460lm
550352 warm white





LIGHT EYE PENDANT LUMINAIRE

230~

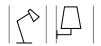

Series: Page 047, 165

Socket/Bulb:
 GU10/ES111 (excl.)
 75W max.

Versions:
 chrome

Art. No.:
 153112

Material:
 Steel
 Black textile-coated cable

Recommended bulb:
 75W, 24°, 2700K, 2000cd
 575672

Dimensions:
 Ø/H: 15/12 cm

PIRUS

230~

Socket/Bulb:
 E14/AGL candle shape (excl.)
 40W max.
 or
 E14/EnergySaver (excl.)
 up to max. Ø/L: 3,8/11,7 cm

Versions:
 Glass satined
 chrome

Art. No.:
 153121

Material:
 Steel/glass
 Red textile-coated cable

Recommended bulb:
 7W, 2700K, 285lm, EEK=A
 508800

Dimensions:
 Ø/H: 14/19 cm



PURI

230~

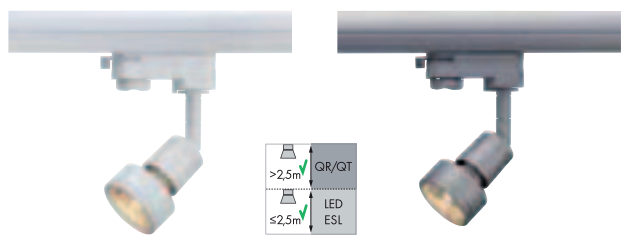

Socket/Bulb:
GU10/GU10; ES111 (excl.)
50W max.

Versions:
white
silver grey

Art. No.:
153561
153564

Material:
Aluminium

Dimensions:
L/H/Ø: 5/10/3,7 cm
Head-Ø/L: 3,5/3,5 cm

Accessory/Included parts:
Deco ring (incl.)

Deco ring for the GU10 bulb is included in the delivery.
The Puri spotlights can be equipped with GU10 or ES111 bulbs.

Recommended bulb:

PowerLED 6W
25°, 3000K, 1100cd, 320lm
560103



Recommended bulb:

35W EnergySaver # 50W
20°, 2800K, 1200cd
575370



BIMA 1

230~

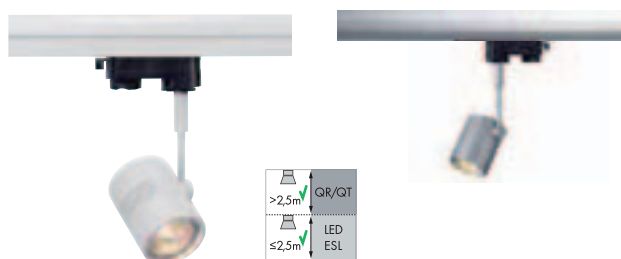

Socket/Bulb:
GU10/GU10 (excl.)
50W max.

Versions:
matt white
silver grey

Art. No.:
152241
152242

Material:
Aluminium

Dimensions:
L/H/Ø: 8/15/6 cm
Head-Ø/L: 6/7,8 cm

Recommended bulb:

PowerLED 6W
25°, 3000K, 1100cd, 320lm
560103



Recommended bulb:

35W EnergySaver # 50W
20°, 2800K, 1200cd
575370



BIMA 2

230~

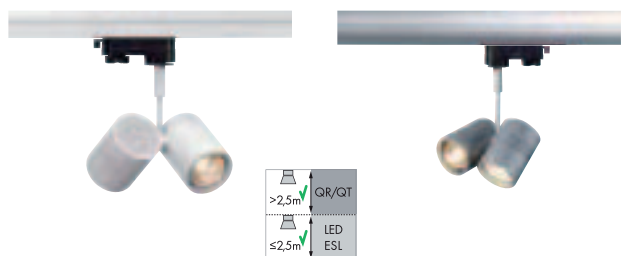

Socket/Bulb:
GU10/GU10 (excl.)
2x 50W max.

Versions:
matt white
silver grey

Art. No.:
152231
152232

Material:
Aluminium

Dimensions:
W/H/D: 8/15/13 cm
Head-Ø/L: 6/8 cm

Recommended bulb:

PowerLED 6W
25°, 3000K, 1100cd, 320lm
560103



Recommended bulb:

35W EnergySaver # 50W
20°, 2800K, 1200cd
575370



Q-TECH® SPOT GU10

230~

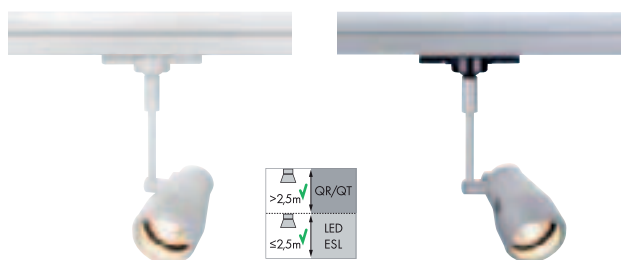

Socket/Bulb:
GU10/GU10 (excl.)
50W max.

Versions:
white
silver grey

Art. No.:
153301
153304

Material:
Aluminium

Dimensions:
Head-Ø: 6 cm
Total-L: 23,5 cm

Recommended bulb:

PowerLED 6W
25°, 3000K, 1100cd, 320lm
560103



Recommended bulb:

35W EnergySaver # 50W
20°, 2800K, 1200cd
575370



AERO GU10 Design by CDC

230~



350°



90°



0,13



Socket/Bulb:
GU10/GU10 (excl.)
50W max.

Material:
Aluminium/plastic

Dimensions:
L/W/H: 9/9/14,5 cm

Versions:
white
silver grey

Art. No.:
151011
151017

Recommended bulb:
35W EnergySaver \approx 50W
20°, 2800K, 1200cd
575370



Recommended bulb:
PowerLED 6W
25°, 3000K, 1100cd, 320lm
560103



PL 2/24 SHOP

230~        

Socket/Bulb:
2G11/TC-L 2G11 (excl.)
2x 24W

Material:
Aluminium/plastic

Dimensions:
L/W/H: 42,7/14/27,5 cm

Accessory/Included parts:
Low-loss ballast (incl.)

Versions:
silver grey/black

Art. No.:
152272

Recommended bulb:
24W, 4000K, 1800lm, EEK=A
508441



TWINTUBE

230~       

Socket/Bulb:
G5/T5 EnergySaver (excl.)
2x 39W

Material:
Housing plastic
Tube acrylic

Dimensions:
L/W/H: 91/19,5/11,5 cm
Tube-Ø: 4,3 cm

Accessory/Included parts:
Electronic ballast (incl.)

Versions:
silver grey

Art. No.:
152182

Recommended bulb:
39W, 4000K, 3220lm
548139

(PU see page 661)



NEPRO 2 26W TC-D

230~        

Socket/Bulb:
G24d-3/TC-D (excl.)
26W

Material:
Aluminium/Stainless steel 304

Dimensions:
L/W/H: 22,2/11,6/13,5 cm

Accessory/Included parts:
Conventional ballast (incl.)

Versions:
white
silver grey

Art. No.:
153551
153554

Recommended bulb:
26W, 4000K, 1800lm, EEK=B
508326

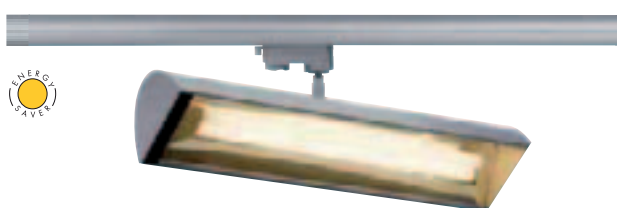

NEPRO 2 PL

230~        

Socket/Bulb:
2G11/TC-L (excl.)
36W

Material:
Aluminium

Dimensions:
L/W/H: 48/11,5/18,5 cm

Accessory/Included parts:
Electronic ballast (incl.)

Versions:
silver grey

Art. No.:
153544

Recommended bulb:
36W, 4000K, 2900lm, EEK=A
590145

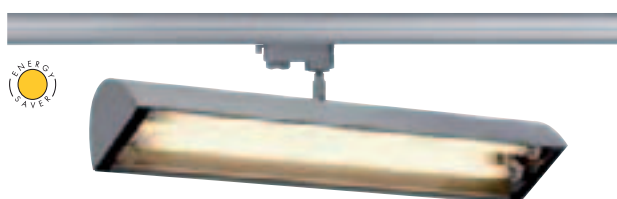

NEPRO 2 T5

230~        

Socket/Bulb:
G5/EnergySaver (excl.)
2x 24W

Material:
Aluminium

Dimensions:
L/W/H: 60,5/12/19 cm

Accessory/Included parts:
Electronic ballast (incl.)

Versions:
silver grey

Art. No.:
153524

Recommended bulb:
24W, 4000K, 1700lm
548124

(PU see page 661)





EUTRAC®

Eutrac®-System The 5 conductor Eutrac® surface track consists of an extruded aluminium profile which also functions as earth and two inserted plastic profiles carrying four embedded 2.5 mm² copper conductors. Any given profile can be easily cut to length on site. It is not necessary to cut back or bend back the conductors. The track has pre-punched oval holes and may be used within handreach.

EUTRAC® 3PHASE RECESSED TRACK

230~

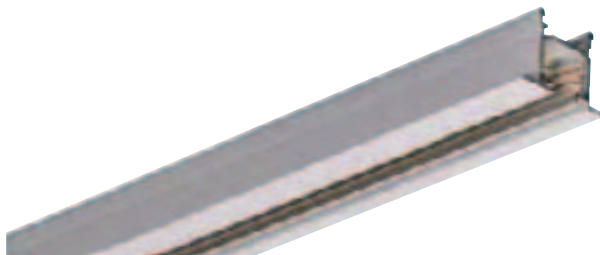
 16A
max.

Material:
Aluminium/plastic

Versions:
white/2 m

Art. No.:
145211

Dimensions:
2m L/W/H: 200/5,9/4,1 cm
3m L/W/H: 300/5,9/4,1 cm

white/3 m

145311

Note:
Flexible suspension at spring clips over arrow-shaped profilings.
Support bracket max. 4kg/m loadable.

BASIC COMPONENTS Eutrac® 3Phase recessed track

230~ 16A max.

Feed-in 1
Earth left, white
Art. No.: 145541

Feed-in 2
Earth right, white
145771

Longitudinal connector
electr./mech., white
Art. No.: 145571

Steel/plastic
Inboard.

End cap
white
Art. No.: 145621

Plastic

L/W/H: 2,7/6/3,2 cm
visible-L/W/H: 1,1/6/0,1 cm

230~ 16A max.

L-connector 1
Earth outside, white
Art. No.: 145761

L-connector 2
Earth inside, white
145751

Plastic

With feed-in possibility.

L/W/H: 16/16/3,2 cm
visible L/W/H: 11,5/11,5/0,2 cm

Spring clip
white, 6 pieces
Art. No.: 145551

Steel

For on-site fast suspending brackets.



EUTRAC® 3PHASE SURFACE TRACK

230~ 16A max.



Material:
Aluminium/plastic

Dimensions:
1 m L/W/H: 100/3,6/3,2 cm
2 m L/W/H: 200/3,6/3,2 cm
3 m L/W/H: 300/3,6/3,2 cm

Versions:	Art. No.:
1 m	
black	145100
white	145101
silver grey anodized	145102
2 m	
black	145200
white	145201
silver grey anodized	145202
3 m	
black	145300
white	145301
silver grey anodized	145302



BASIC COMPONENTS Eutrac® 3Phase surface track

230~ 16A max.

Feed-in 1, Earth left Art. No.:

black	145510
white	145511
silver grey	145514

Feed-in 2, Earth right Art. No.:

black	145520
white	145521
silver grey	145524

230~ 16A max.

Middle feed-in Art. No.:

black	145530
white	145531
silver grey	145534

Plastic

Can be positioned at any part of the track.

Not suitable as longitudinal connector.

Also suitable for Eutrac® recessed track

230~ 16A max.

Flex connector Art. No.:

black	145580
white	145581
silver grey	145584

Plastic

For radius of 30°-330°.

With feed-in possibility.

230~ 16A max.

Pendant connector Art. No.:

black	145600
white	145601
silver grey	145604

Aluminium

With suspension possibility for rope and pendant suspension for M13 thread.

230~ 16A max.

Longitudinal connector, electrical Art. No.:

black	145560
white	145561
silver grey	145564

Plastic

Inboard. In case of rope and pendant suspension, the pendant coupler is due to static reasons additionally needed (145600/-1/-4).

230~ 16A max.

Longitudinal connector Art. No.:

black	145660
white	145661
silver grey	145664

Plastic

With feed-in possibility.

	230~ 16A max.		L-connector 1 Earth outside, black Earth outside, white	Art. No.: 145670 145671		230~ 16A max.		T-connector 1 Earth right, black Earth right, white	Art. No.: 145640 145641
	Earth outside, silver grey 145674	L-connector 2 Earth inside, black Earth inside, white	145680 145681	Earth right, silver grey 145644		T-connector 2 Earth left, black Earth left, white	145630 145631	Earth inside, silver grey 145684	Earth left, silver grey 145634
With feed-in possibility.			With feed-in possibility.						

	230~ 16A max.		X-connector black white	Art. No.: 145690 145691		230~ 6,3A max.		Power socket adapter black white	Art. No.: 145700 145701
	silver grey 145694	Plastic	With feed-in possibility. 2 power circuits.	Plastic With feed-in possibility.		For the connection of devices with protection class I (system Schuko) or universally applicable for device flat plugs with protection class II, for mains voltage 220-240V with fuse 6,3A.			
Also suitable for Eutrac® recessed track			Also suitable for Eutrac® recessed track						











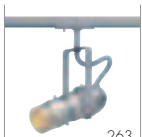

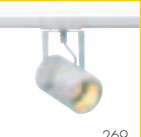

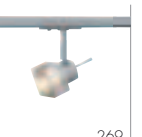





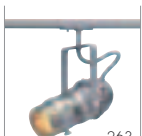
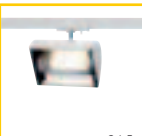

	230~ 10A max.		Lamp adapter black white silver grey	Art. No.: 145990 145991 145994		10kg max.		Lamp adapter, mech. black white silver grey	Art. No.: 144980 144981 144984
	Polyamide 66	Threaded piece, Strain relief (incl.)	Also suitable for Eutrac® recessed track	Aluminium Thread M8		With hole for pendant luminaires with steel cable suspension.			

	Pendant clip M13 thread black white	Art. No.: 145730 145731		End cap black white	Art. No.: 145590 145591
	silver grey 145734	Aluminium For suspension via rope or pendant suspension.		silver grey 145594	Plastic

	Pendant rod fixed M13 thread 0,6 m, 0,28 kg black white	Art. No.: 145720 145721		Wire rope suspension M13 thread 1,5 m, 0,05 kg, chrome	Art. No.: 145800
	silver grey 145724	1,2 m, 0,49 kg black white		3,0 m, 0,10 kg, chrome 145810	6,2 m, 0,20 kg, chrome 145820
silver grey 145714	Can be cut on site, to use with pendant clip (see above).		Ceiling canopy black white silver grey	Art. No.: 145740 145741 145744	Load max. 10 kg Ø/H: 12,5/6,2 cm

1 PHASE TRACK SYSTEM

All lamps are equipped with a 1Phase-adapter or 1Phase pendant-adapter

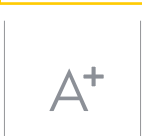
Spotlights for low-voltage bulb QRB111	 264						
Spotlights for high-voltage bulb GU10	 263	 269	 269	 270	 270	 269	 269
	 270	 270					
Spotlights für high-voltage bulb ES111	 264						
Spotlights für high-voltage bulb R7s	 262						
Spotlights für high-voltage bulb PAR	 263						
Spotlights für energy-saving bulb	 265	 265	 267	 265	 267	 267	 267
Professional spots for the commercial use PROFICIENT light	 262	 262					
LED spotlights	 261	 261	 261				
Accessory for 1Phase track system	 A+ 272-273						

LED TRACKSPOT 3x 3W

230~

 LED
3 pce.

Bulb:
PowerLED (incl.)
3x 3W

Material:
Aluminium/plastic

Dimensions:
L/W/H: 9/7,3/14,5 cm

Accessory/Included parts:
LED driver (incl.)

Versions:
3000K, 410lm
white
silver grey

Art. No.:

 30° 143881
30° 143884

EURO SPOT INTEGRATED LED

230~

 1 Module
6 PowerLEDs

Bulb:
PHILIPS
Fortimo Integrated Spot (incl.)

Material:
Aluminium

Dimensions:
Head Ø: 8 cm
L/H: 15/22 cm

Versions:
3000K, 13W, 640lm, Ra80
white
silver grey

Art. No.:

 24° 143821
24° 143824

EURO SPOT LED DISK 800

230~

 Module
1 PlanarLED

Bulb:
PHILIPS
Fortimo LED Disk Module (incl.)

Material:
Aluminium/glass

Dimensions:
Head Ø/L: 12,5/14 cm
L/H: 14/27 cm

Versions:
2700K, 14,5W, 800lm, Ra90
white
silver grey

Art. No.:

 143831
143834

 4000K, 15,2W, 850lm, Ra80
white
silver grey

Art. No.:

 143841
143844

D-RECTION 35W, GU6,5 Design by CDC

230~

PROFIEFFICIENT
light.

Socket/Bulb:
GU6,5/CMHT (excl.)
35W

Versions:
white
silver grey

Art. No.:
143871
143874

Material:
Aluminium/glass

Dimensions:
L/W/H: 24/9,5/16,5 cm

Recommended bulb:
35W, 4200K, 3400lm, Ra90
507031

Accessory/Included parts:
Electronic ballast (incl.)
Deco ring (incl.)
Reflector (excl.)

Recommended accessory:

Reflector, Ø/H: 9,5/8 cm

153721 12°

153722 24°

153723 38°

153726 60°

Q-TECH® SPOT G12 HOR

230~

PROFIEFFICIENT
light.

Socket/Bulb:
G12/HQIT; CDM-T (excl.)
70W

Versions:
white ▼
silver grey ▼

Art. No.:
143671
143674

Material:
Aluminium

Dimensions:
Head-Ø: 12 cm
W/H 30,5/16 cm

Recommended bulb:
70W, 4200K, 6600lm
507131

Accessory/Included parts:
Electronic ballast (incl.)
Reflector (excl.)

Recommended accessory:

Reflector Product-Ø: 10,5 cm

153241 ▼ 24°

153244 ▼ 44°

153246 ▼ 60°

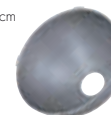
SKELETTO

230~



Series: Page 318

Socket/Bulb:
R7s/R7s, 78 mm (excl.)
150W max.

Versions:
white
silver grey

Art. No.:
143321
143327

Material:
Steel

Dimensions:
L/W/H: 17/15,5/5 cm

Recommended bulb:
100W EnergySaver ≙ 150W
2700K, 1900lm, EEK=C
519215

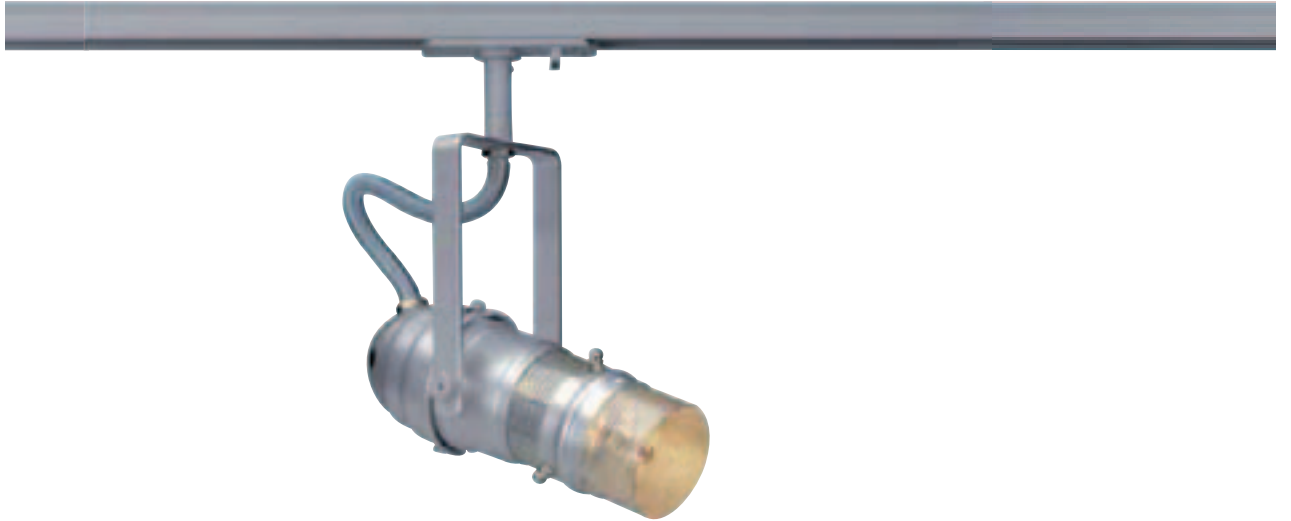

PAR MESH 16

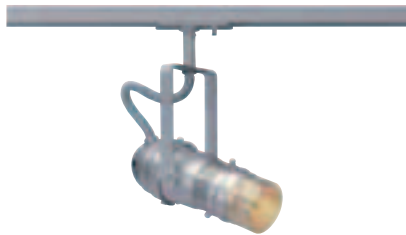
230~

Socket/Bulb:
 GU10/GU10 (excl.)
 50W max.

Versions:
 silver grey

Art. No.:
 143704

Dimensions:
 Ø/L: 9/24 cm

Material:
 Aluminium

Recommended bulb:
 35W EnergySaver \approx 50W
 20°, 2800K, 1200cd
 575370

Recommended bulb:
 COB LED 5,6W
 60°, 2700K-3000K, 300lm
 551332

PAR MESH 20

230~

Socket/Bulb:
 E27/PAR20 (excl.)
 75W max.

Versions:
 silver grey

Art. No.:
 143714

Dimensions:
 Ø/L: 16/27 cm

Material:
 Aluminium

Recommended bulb:
 75W, 24°, 5500cd
 519727

PAR MESH 30

230~

Socket/Bulb:
 E27/PAR30 (excl.)
 150W max.

Versions:
 silver grey

Art. No.:
 143724

Dimensions:
 Ø/L: 18/39 cm

Material:
 Aluminium

Recommended bulb:
 150W, 24°, 11000cd
 519739



TEC 1 QRB



Socket/Bulb:
G53/QRB111 (excl.)
50W max.

Dimensions:
L/W/H: 14/18/16 cm

Material:
Aluminium

Accessory/Included parts:
Electronic transformer (incl.)

Versions:
silver grey

Art. No.:
143512

Recommended bulb:
35W EnergySaver \neq 50W
545512 6°, 3000K, 22500cd
545522 24°, 3000K, 4500cd



TEC 2 QRB



Socket/Bulb:
G53/QRB111 (excl.)
2x 50W max.

Dimensions:
L/W/H: 14/31,5/16 cm

Material:
Aluminium

Accessory/Included parts:
Electronic transformer (incl.)

Versions:
silver grey

Art. No.:
143522

Recommended bulb:
35W EnergySaver \neq 50W
545512 6°, 3000K, 22500cd
545522 24°, 3000K, 4500cd



EURO SPOT ES111

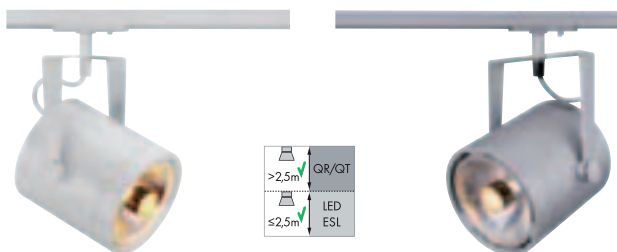

Socket/Bulb:
GU10/ES111 (excl.)
75W max.

Material:
Aluminium

Dimensions:
L/W: 20/14,5 cm
Head-Ø/L: 12,5/14,5 cm

Versions:
white
silver grey

Art. No.:
143801
143804

Recommended bulb:
75W, 24°, 2700K, 2000cd
575672



KASPO ES111



Socket/Bulb:
GU10/ES111 (excl.)
75W max.

Material:
Aluminium

Dimensions:
Head-Ø/H: 12,7/18 cm

Versions:
silver grey

Art. No.:
143754

Recommended bulb:
75W, 24°, 2700K, 2000cd
575672



LUNA 1



Socket/Bulb:
GU10/ES111 (excl.)
75W max.
or
DomeLED ES111 (excl.)
9W

Material:
Aluminium

Dimensions:
W/H/D: 7,5/21/4 cm

Accessory/Included parts:
Deco ring (excl.)

Recommended accessory:
Deco ring 111
Not suitable for DomeLED
151051



Versions:
silver grey

Art. No.:
143482

Recommended bulb:
75W, 24°, 2700K, 2000cd
575672



Recommended bulb:
DomeLED 9W, 60°, 176lm
550392 warm white



TWINTUBE

230~

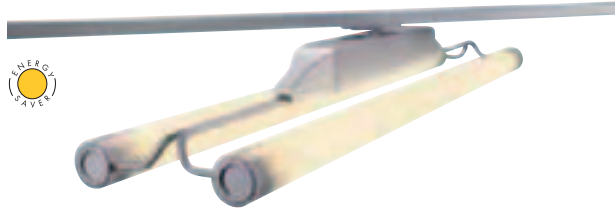

Socket/Bulb:
G5/T5 EnergySaver (excl.)
2x 39W

Versions:
silver grey

Art. No.:
143402

Material:
Housing plastic
Tube acrylic

Dimensions:
L/W/H: 91/19,5/10 cm
Tube-Ø: 4,3 cm

Recommended bulb:
39W, 3000K, 3500lm
548039

(PU see page 661)

Accessory/Included parts:
Electronic ballast (incl.)

NEPRO 2 26W TC-D

230~



Socket/Bulb:
G24d-3/TC-D (excl.)
26W

Versions:
white
silver grey

Art. No.:
143851
143854

Material:
Aluminium/Stainless steel 304

Dimensions:
L/W/H: 22,2/11,6/13,5 cm

Recommended bulb:
26W, 4000K, 1800lm, EEK=B
508326

Accessory/Included parts:
Conventional ballast (incl.)

SOPRANA PD-3

230~

1,5m



Socket/Bulb:
E27/AGL (excl.)
40W max.
or
E27/EnergySaver (excl.)
up to max. length: 14,5 cm

Versions:
1 Phase-adapter white
Shade white 143911
Shade beige 143921

1 Phase-adapter silver grey
Shade white 143914
Shade beige 143924

Material:
Steel/textile/PS



Recommended bulb:
20W, 2700K, 1150lm, EEK=A
508830





TONGA 4

230~



Socket/Bulb:
E14/AGL (excl.)
60W max.
or
E14/EnergySaver (excl.)
up to max. Ø/L: 5/13 cm

Material:
Ceramic

Dimensions:
Ø/H: 15/22 cm

Versions:
Shade white

Art. No.:
143594

Recommended bulb:
11W, 2700K, 530lm, EEK=A
508810

COMMO PD-1

230~



Socket/Bulb:
GX53/GX53 (excl.)
13W max.

Material:
Steel/glass

Dimensions:
Ø/H: 10/25 cm

Versions:
chrome/glass partial satiné
Adapter white
Adapter silver grey

Art. No.:
143901
143904

Recommended bulb:
9W, 2700K, 260lm
508860

SO-TOO

230~



Socket/Bulb:
E27/EnergySaver (excl.)
23W max.
up to max. Ø/L: 6,5/19 cm

Material:
Steel/glass

Dimensions:
Ø/H: 15/27 cm
Glass-Ø/H: 15/21 cm

Versions:
white
chrome

Art. No.:
143611
143612

Recommended bulb:
23W, 2700K, 1350lm, EEK=A
508970



Recommended bulb:
SMD LED 10W
2800K-3000K, 700lm, EEK=A
551342

PIRUS

230~



Socket/Bulb:
E14/AGL Candle shap (excl.)
40W max.
or
E14/EnergySaver (excl.)
up to max. Ø/L: 3,8/11,7 cm

Material:
Steel/glass
Red textile-coated cable

Dimensions:
Ø/H: 14/19 cm

Versions:
chrome

Art. No.:
143601

Recommended bulb:
11W, 2700K, 530lm, EEK=A
508810





BIMA 1

230~

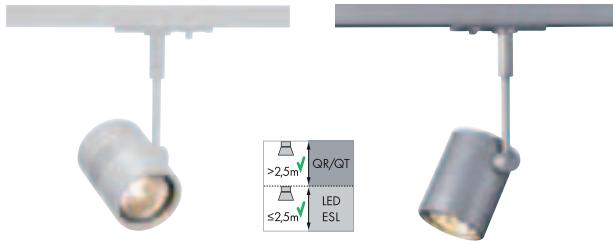

Socket/Bulb:
GU10/GU10 (excl.)
50W max.

Material:
Aluminium

Dimensions:
L/H/Ø: 8/14/6 cm
Head-Ø/L: 6/8 cm

Versions:
matt white
silver grey

Art. No.:
143441
143442

Recommended bulb:
35W EnergySaver ± 50W
20°, 2800K, 1200cd
575370

BIMA 2

230~

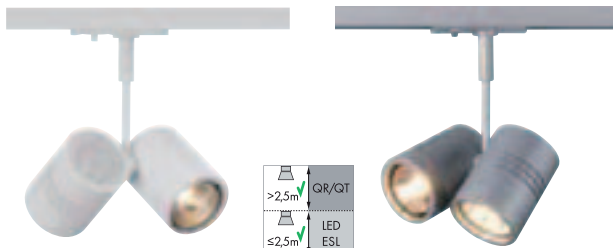

Socket/Bulb:
GU10/GU10 (excl.)
2x 50W max.

Material:
Aluminium

Dimensions:
L/H/Ø: 8/14/13 cm
Head-Ø/L: 6/8 cm

Versions:
matt white
silver grey

Art. No.:
143431
143432

Recommended bulb:
35W EnergySaver ± 50W
20°, 2800K, 1200cd
575370

EURO SPOT GU10

230~

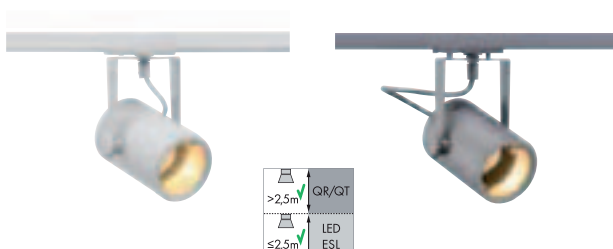

Socket/Bulb:
GU10/GU10 (excl.)
50W max.

Material:
Aluminium/glass

Dimensions:
L/W/H: 12,3/15,2/8 cm

Versions:
white
silver grey

Art. No.:
143811
143814

Recommended bulb:
35W EnergySaver ± 50W
20°, 2800K, 1200cd
575370

TOBU

230~



Socket/Bulb:
GU10/GU10 (excl.)
50W max.

Material:
Steel/glass

Dimensions:
L/W/H: 16,5/8/6 cm

Versions:
silver grey
Glass partial satined

Art. No.:
143372

Recommended bulb:
35W EnergySaver ± 50W
20°, 2800K, 1200cd
575370

BLOX

230~

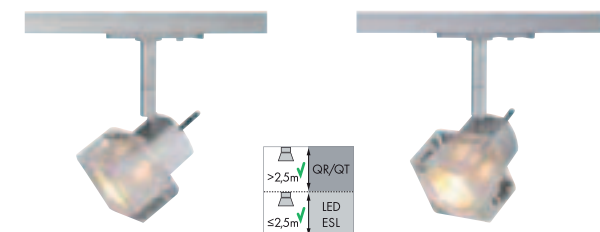

Socket/Bulb:
GU10/GU10 (excl.)
50W max.

Material:
Aluminium/glass

Dimensions:
L/W: 10,5/15,5 cm

Versions:
silver grey

Art. No.:
143502

Recommended bulb:
35W EnergySaver ± 50W
20°, 2800K, 1200cd
575370





KASPO

230~



Socket/Bulb:
GU10/GU10 (excl.)
50W max.

Versions:
silver grey

Art. No.:
143422

Material:
Aluminium

Dimensions:
W/H/D: 7/31,5/8,5 cm
Head-Ø: 5,5 cm

Recommended bulb:
35W EnergySaver \neq 50W
20°, 2800K, 1200cd
575370



Recommended bulb:
COB LED 5,6W
60°, 2700K-3000K, 300lm
551332



Q-TECH® SPOT GU10

230~



Socket/Bulb:
GU10/GU10 (excl.)
50W max.

Versions:
white ▼
silver grey ▼

Art. No.:
143631
143634

Material:
Aluminium

Dimensions:
Head-Ø: 6 cm
Total-L: 21,5 cm

Recommended bulb:
35W EnergySaver \neq 50W
20°, 2800K, 1200cd
575370

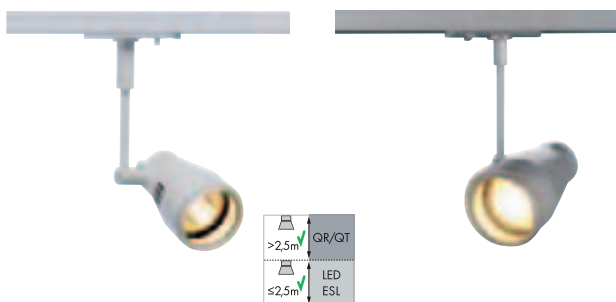

AERO GU10 Design by CDC

230~



Socket/Bulb:
GU10/GU10 (excl.)
50W max.

Versions:
white
silver grey

Art. No.:
143301
143307

Material:
Aluminium/plastic

Dimensions:
L/W/H: 7/7/11 cm

Recommended bulb:
35W EnergySaver \neq 50W
20°, 2800K, 1200cd
575370

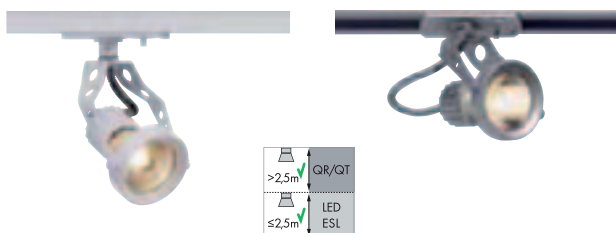

PURI

230~



Socket/Bulb:
GU10/GU10; ES111 (excl.)
50W max.

Versions:
white
silver grey

Art. No.:
143391
143392

Material:
Aluminium/plastic

Dimensions:
L/W/H: 8/3,5/9 cm
Head-Ø/L: 3,5/3,5 cm

Recommended bulb:
35W EnergySaver \neq 50W
20°, 2800K, 1200cd
575370

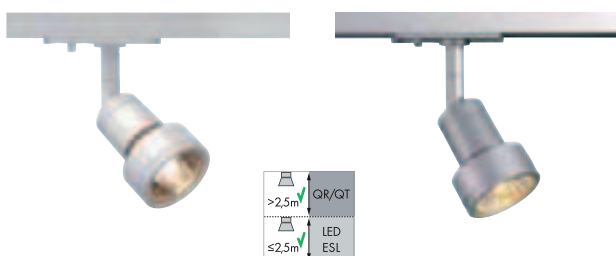

The Puri spotlights can be equipped with GU10 or ES111 bulbs.
Deco ring for the GU10 bulb is included in the delivery.



BASIC COMPONENTS 1Phase high-voltage recessed track



The details refer to installation in solid ceilings.
When mounting in cavity ceilings, the retaining bracket (143230) is needed - in that case the installation depth is 4 cm!

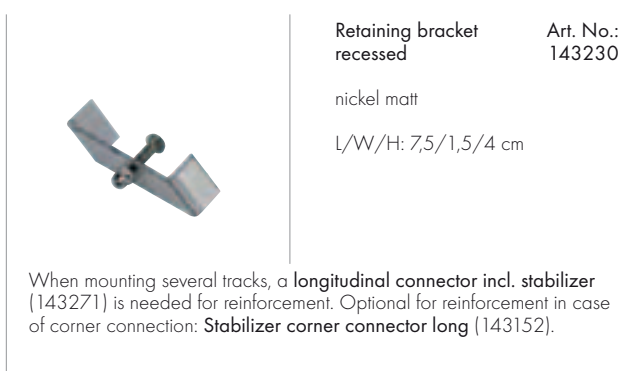
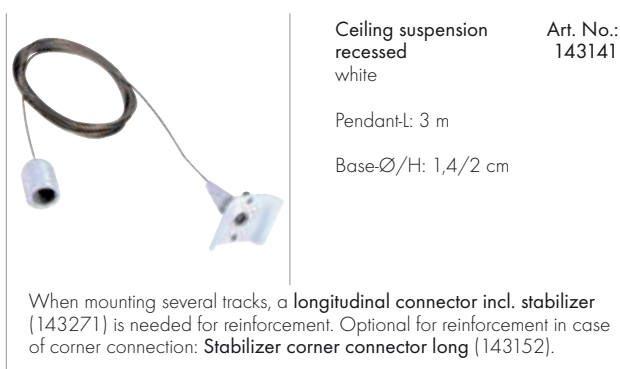
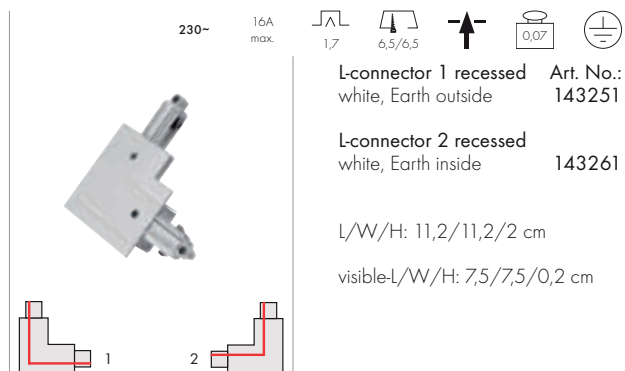
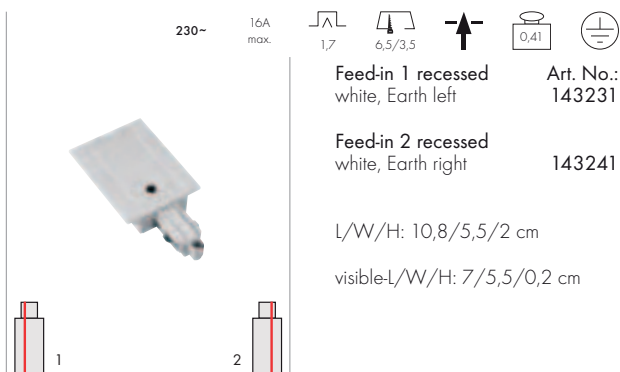

BASIC COMPONENTS 1Phase high-voltage track system

 <p>1,8 cm 230~ 3,5 cm 16A max. 1,34</p>	<p>1 Phase track Art. No.: white 143021 silver grey 143022</p> <p>L/W/H: 200/3,5/1,8 cm Conductor cross-section: 4 mm²</p>	 <p>230~ 16A max. 0,04</p> <p>Feed-in 1 Art. No.: white, earth left 143031 silver grey, earth left 143032</p> <p>Feed-in 2 Art. No.: white, earth right 143041 silver grey, earth right 143042</p> <p>Visible-L/W/H: 6,5/3,4/1,8 cm Total-L: 10,5 cm</p>
	<p>230~ 16A max. 0,05</p> <p>Longitudinal connector with feed-in possibility Art. No.: white 143101 silver grey 143102</p> <p>Visible-L/W/H: 9,5/3,4/1,8 cm Total-L: 17,5 cm</p>	 <p>230~ 16A max. 0,03</p> <p>Longitudinal connector, electrical Art. No.: white 143091 silver grey 143092</p> <p>Visible L/W/H: 0,4/3,4/1,8 cm Total-L: 6,4 cm</p>
	<p>230~ 16A max. 0,05</p> <p>L-connector 1 Art. No.: white, Earth outside 143051 silver grey, Earth outside 143052</p> <p>L-connector 2 Art. No.: white, Earth inside 143061 silver grey, Earth inside 143062</p> <p>With feed-in possibility. Visible-L/W/H: 6,5/6,5/1,8 cm Total-L: 10,5 cm</p>	 <p>230~ 16A max. 0,1</p> <p>T-connector 1 Art. No.: white, earth left 143071 silver grey, earth left 143072</p> <p>L-connector 2 Art. No.: white, earth right 143081 silver grey, earth right 143082</p> <p>With feed-in possibility. Visible-L/W/H: 9,5/6,5/1,8 cm Total-L: 17 cm</p>
	<p>230~ 16A max. 0,1</p> <p>Flex connector Art. No.: white 143111 silver grey 143112</p> <p>Visible-L/W/H: 16,1/3,4/1,8 cm Total-L: 23,7 cm Bending radius from 70°-180°.</p>	 <p>Stabilizer Art. No.: Longitud. connector long 143151 nickel matt</p> <p>L/W/H: 19,7/3,2/1,3 cm For reinforcement when mounting several tracks with ceiling suspension (143141/-2)</p>
	<p>Stabilizer Art. No.: Corner connector long 143152 nickel matt</p> <p>L/W/H: 11,5/11,5/1,3 cm For reinforcement when mounting several tracks with ceiling suspension (143141/-2)</p>	 <p>End cap Art. No.: white/2 pce. 143131 silver grey/2 pce. 143132</p> <p>L/W/H: 0,4/3,4/1,8 cm</p>
	<p>230~ 6A max. 0,04</p> <p>1 Phase pendant-adaptor Art. No.: white 143121 silver grey 143124</p> <p>mech. load: 20N max. Threaded piece (incl.) Strain relief (incl.) L/W/H: 8,2/3,5/4,2 cm Visible-L/W/H: 8,2/3,5/2,7 cm</p>	 <p>230~ 6A max. 0,1</p> <p>Ceiling canopy Art. No.: white 143381 silver grey 143382</p> <p>Plastic Ø/H: 12/2,5 cm Load max. 2 kg</p>

EASYTEC® II CHROME/BLACK

All lamps are equipped with an Easytec® II-adapter or Easytec® II pendant lamp adapter.

Spotlights for
Easytec® II
chrome/black



Pendant luminaires
for Easytec® II
chrome/black

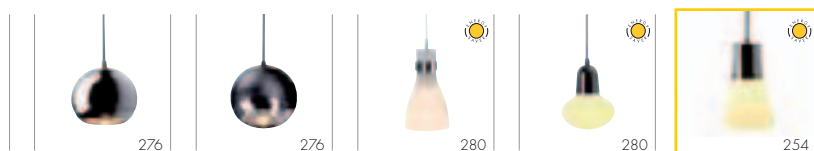

Accessory for
Easytec® II
chrome/black



EASYTEC® II SILVER GREY

All lamps are equipped with an Easytec® II-adapter or Easytec® II pendant lamp adapter.

Spotlights for
Easytec® II
silver grey

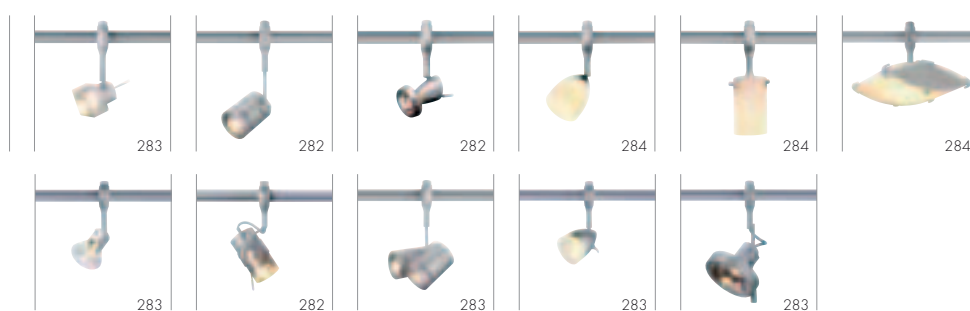

Pendant luminaires
for Easytec® II
silver grey

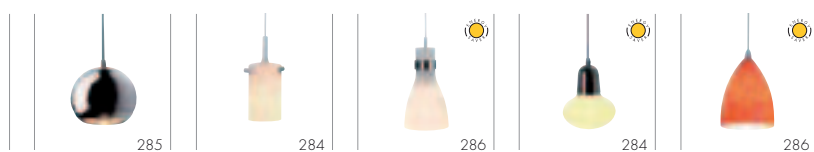

Accessory for
Easytec® II
silver grey

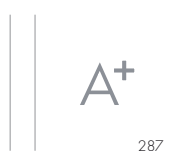



LIGHT EYE PENDANT

230~    

Socket/Bulb:
GU10/ES111 (excl.)
75W max.

Material:
Steel
Black textile cable

Dimensions:
Head-Ø/H: 15/14,5 cm

Versions:
chrome/black

Art. No.:
185590

Recommended bulb:
75W, 24°, 2700K, 2000cd
575672



LIGHT EYE ES111 SPOT

230~     

Socket/Bulb:
GU10/ES111 (excl.)
75W max.

Material:
Steel

Dimensions:
Head-Ø/H: 15/26 cm

Versions:
chrome/black

Art. No.:
185580

Recommended bulb:
75W, 24°, 2700K, 2000cd
575672



LIGHT EYE PENDANT

230~    

Series: Page 047, 165



Socket/Bulb:
GU10/ES111 (excl.)
75W max.

Material:
Steel
Black textile cable

Dimensions:
Head-Ø/H: 15/14,5 cm

Versions:
chrome

Art. No.:
185592

Recommended bulb:
75W, 24°, 2700K, 2000cd
575672



LIGHT EYE ES111 SPOT

230~     

Series: Page 047, 165



Socket/Bulb:
GU10/ES111 (excl.)
75W max.

Material:
Steel

Dimensions:
Head-Ø/H: 15/26 cm

Versions:
chrome

Art. No.:
185582

Recommended bulb:
75W, 24°, 2700K, 2000cd
575672



LIGHT EYE GU10 SPOT

230~     

Socket/Bulb:
GU10/GU10 (excl.)
50W max.

Material:
Steel

Dimensions:
W/H: 10/20 cm
Head-Ø: 9 cm

Versions:
chrome





Art. No.:
185692

Recommended bulb:
35W EnergySaver ≠ 50W
20°, 2800K, 1200cd
575370





BIMA 1

230~     

Socket/Bulb:
GU10/GU10 (excl.)
50W max.

Material:
Aluminium

Dimensions:
W/H: 7,5/23 cm
Head-Ø/H: 6/8 cm

Versions:
chrome/black

Art. No.:
185450

Recommended bulb:
35W EnergySaver ≠ 50W
20°, 2800K, 1200cd
575370



RAKA SPOT Design by CDC

230~     

Socket/Bulb:
GU10/GU10 (excl.)
50W max.

Material:
Aluminium/steel

Dimensions:
L/W/H: 9/6/24 cm

Versions:
chrome/black

Art. No.:
185712

Recommended bulb:
35W EnergySaver ≠ 50W
20°, 2800K, 1200cd
575370



Recommended bulb:
COB LED 5,6W
60°, 2700K-3000K, 300lm
551332

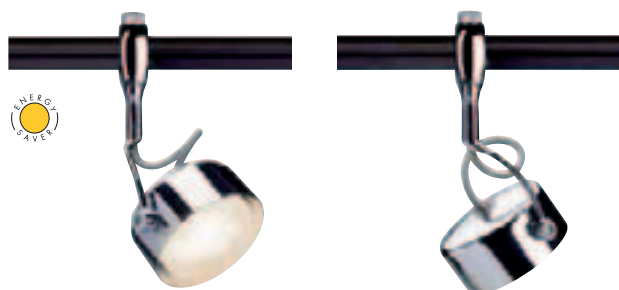

GX53 SPOT

230~     

Socket/Bulb:
GX53/GX53 EnergySaver (excl.)
13W max.
or LED GX53, 2,8W (excl.)
or PowerLED GX53, 3x 1,4W (excl.)
or Shoplight GX53 11W (excl.)

Material:
Steel

Dimensions:
L/W/Ø: 21/10,5/9 cm

Versions:
chrome

Art. No.:
185742

Recommended bulb:
9W, 2700K, 260lm
508860

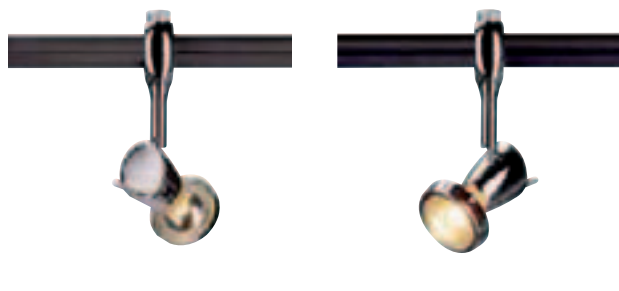

SIENA

230~     

Socket/Bulb:
GU10/GU10; ES111 (excl.)
75W max.

Material:
Aluminium

Dimensions:
Ø/L: 4,4/15,5 cm

Accessory/Included parts:
Deco ring for GU10 (incl.)

Versions:
chrome

Art. No.:
185092

Recommended bulb:
35W EnergySaver ≠ 50W
20°, 2800K, 1200cd
575370



Recommended bulb:
COB LED 5,6W
60°, 2700K-3000K, 300lm
551332

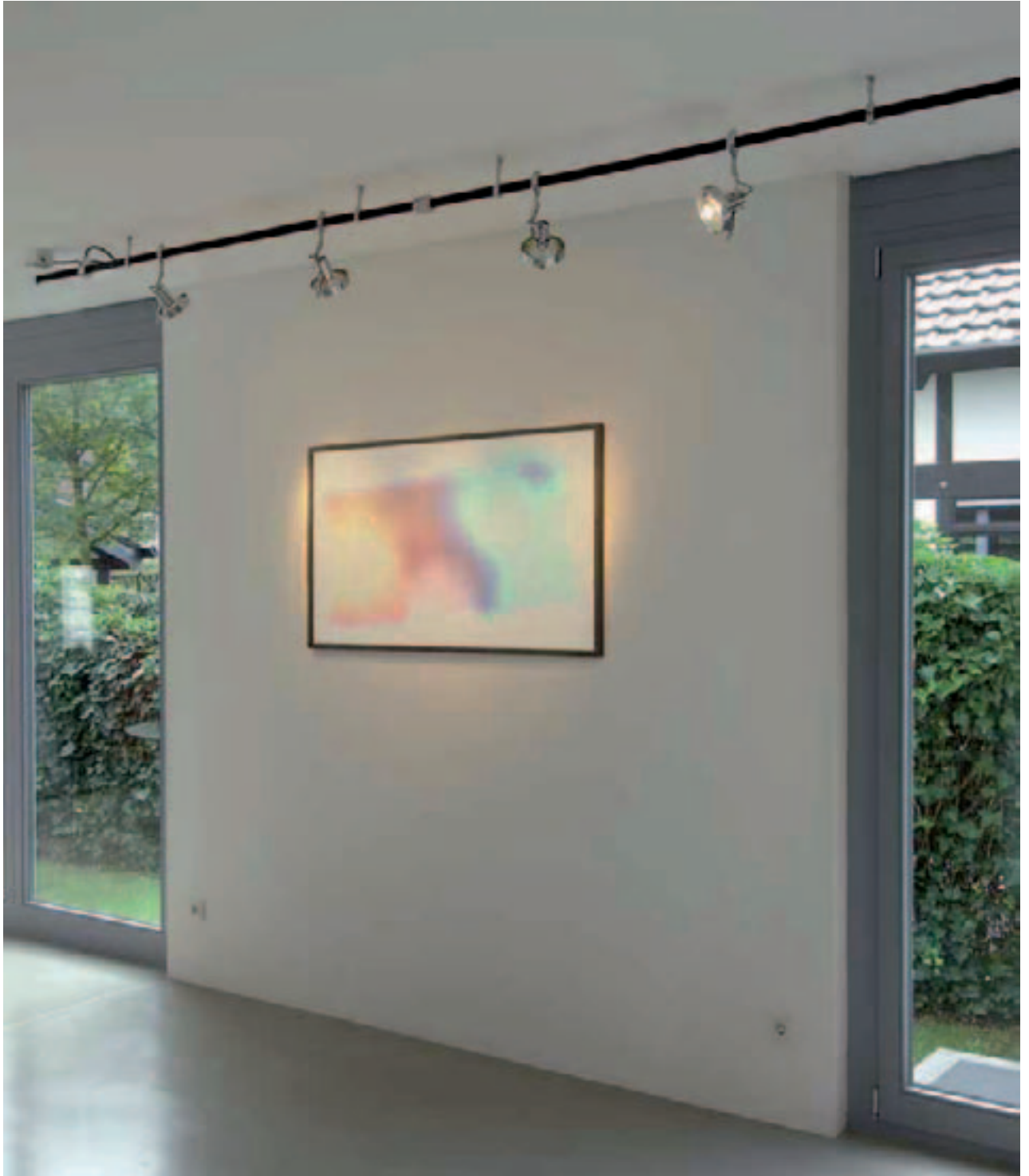

YOKI ES111 Design by CDC/FGI

230~



Socket/Bulb:
GU10/ES111 (excl.)
75W max.

Material:
Aluminium

Dimensions:
L/W/H: 8,5/5/25,5 cm

Accessory/Included parts:
Deco ring (incl.)

Without deco ring suitable for
DomeLED ES111 bulb.

Versions:
chrome

Art. No.:
185622

Recommended bulb:
75W, 24°, 2700K, 2000cd
575672



Recommended bulb:
PowerLED 10W, 40°, 460lm
550352 warm white



>2,5m	QR/QT
≤2,5m	LED ESL



BIBA 3

230~



Socket/Bulb:
E14/AGL (excl.)
60W max.
or
E14/EnergySaver (excl.)
up to max. Ø/H: 5/13 cm

Material:
Steel/glass

Dimensions:
Glass-Ø/H: 13/26 cm

Versions:
Glass satined
chrome

Art. No.:
185521

Recommended bulb:
11W, 2700K, 530lm, EEK=A
508810



SO-TOO PENDANT LUMINAIRE

230~



Socket/Bulb:
E27/EnergySaver (excl.)
23W max.
up to max. Ø/L: 6,5/19 cm

Material:
Steel/glass
Black textile-coated cable

Dimensions:
Ø/H: 15/27 cm
Glass-Ø/H: 15/21 cm

Versions:
chrome

Art. No.:
185232

Recommended bulb:
23W, 2700K, 1350lm, EEK=A
508970



PIRUS

230~



Socket/Bulb:
E14/AGL candle shape (excl.)
40W max.
or
E14/EnergySaver (excl.)
up to max. Ø/L: 3,8/11,7 cm

Material:
Steel/glass
Red textile-coated cable

Dimensions:
Head-Ø/H: 14/19 cm









Versions:
Glass satined
chrome

Art. No.:
185221

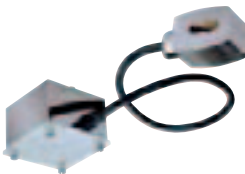
Recommended bulb:
11W, 2700K, 530lm, EEK=A
508810

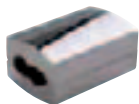
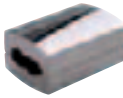



BASIC COMPONENTS Easytec® II, chrome/black

 <p>230~ 16A max.</p> 	<p>Track black, 1 pce. Aluminium L/W/H: 200/1/3 cm</p> <p>Art. No.: 185020</p> <p>2 chrome end caps (incl.)</p>		<p>Feed-in chrome, 1 pce. Aluminium/glass L/W/H: 7,5/7,5/6 cm Cable-L: 40 cm</p> <p>Art. No.: 185002</p>
	<p>Ceiling suspension 10 cm chrome, 1 pce. L: 10 cm</p> <p>Art. No.: 185042</p>		<p>Ceiling suspension flexible chrome, 1 pce. L: adjustable 18-26 cm</p> <p>Art. No.: 185062</p>
	<p>Longitudinal connector chrome, 1 pce.</p> <p>Art. No.: 185032</p>		<p>Insulating connector chrome, 1 pce.</p> <p>Art. No.: 185172</p> <p>For the use of 2 separate circuits.</p>
	<p>Flex connector chrome, 1 pce. L/W/H: 21,5/3/4 cm</p> <p>Art. No.: 185302</p>		<p>Pendant lamp adapter Load 0,7 kg max. L: 13 cm</p> <p>Art. No.: 185294</p>
	<p>End caps chrome, 2 pce.</p> <p>Art. No.: 185142</p>		<p>Bending machine for radius-Ø: > 50 cm</p> <p>Art. No.: ▼ 184000</p>

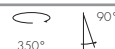

SIENA

230~



Socket/Bulb:
GU10/GU10; ES111 (excl.)
75W max.

Versions:
silver grey

Art. No.:
184092

Material:
Aluminium

Recommended bulb:
35W EnergySaver ≈ 50W
20°, 2800K, 1200cd
575370

Dimensions:
Ø/L: 4,4/15,5 cm

Accessory/Included parts:
Deco ring for GU10 (incl.)

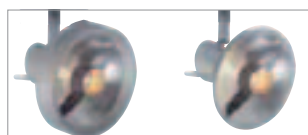

Deco ring for ES111 see page 264.



LIMA

230~

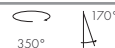

Socket/Bulb:
GU10/GU10 (excl.)
50W max.

Versions:
silver grey

Art. No.:
184492

Material:
Aluminium

Recommended bulb:
35W EnergySaver ≈ 50W
20°, 2800K, 1200cd
575370

Dimensions:
L/W/D: 22/10/12 cm
Glass-Ø: 6 cm

Series: Page 161



Grid insert removable



BIMA 1

230~

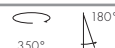

Socket/Bulb:
GU10/GU10 (excl.)
50W max.

Versions:
silver grey

Art. No.:
184452

Material:
Aluminium

Recommended bulb:
35W EnergySaver ≈ 50W
20°, 2800K, 1200cd
575370

Dimensions:
W/H: 7,5/23 cm
Head-Ø/H: 6/8 cm



BIMA 2

230~



Socket/Bulb:
GU10/GU10 (excl.)
2x 50W max.

Material:
Aluminium

Dimensions:
W/H: 13/23 cm
Head-Ø/H: 6/8 cm

Versions:
silver grey

Art. No.:
184442

Recommended bulb:
35W EnergySaver \approx 50W
20°, 2800K, 1200cd
575370

YOKI ES111 Design by CDC/FGL

230~



Socket/Bulb:
GU10/ES111 (excl.)
75W max.

Material:
Aluminium

Dimensions:
L/W/H: 8,5/5/25,5 cm

Accessory/Included parts:
Deco ring (incl.)

Hinweis:
Without deco ring suitable for
DomeLED ES111bulb.

Versions:
silver grey

Art. No.:
184624

Recommended bulb:
75W, 24°, 2700K, 2000cd
575672



Recommended bulb:
PowerLED 10W, 40°, 460lm
550352 warm white

BLOX

230~

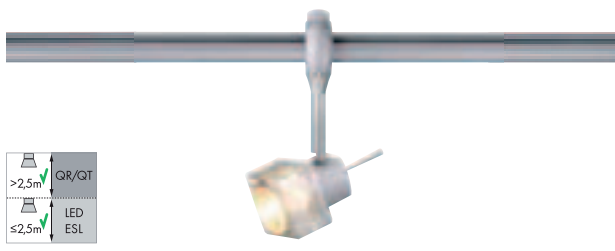

Socket/Bulb:
GU10/GU10 (excl.)
50W max.

Material:
Aluminium/glass

Dimensions:
L/W/H: 19,5/5,5/11 cm

Versions:
silver grey

Art. No.:
184542

Recommended bulb:
35W EnergySaver \approx 50W
20°, 2800K, 1200cd
575370

ANILA

230~

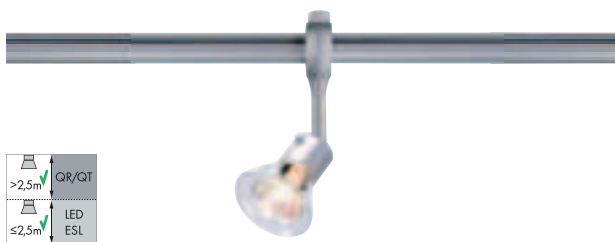

Socket/Bulb:
GU10/GU10 (excl.)
50W max.

Material:
Aluminium/glass

Dimensions:
Ø/L: 7/23,5 cm

Versions:
silver grey

Art. No.:
184634

Recommended bulb:
35W EnergySaver \approx 50W
20°, 2800K, 1200cd
575370

KANO

230~

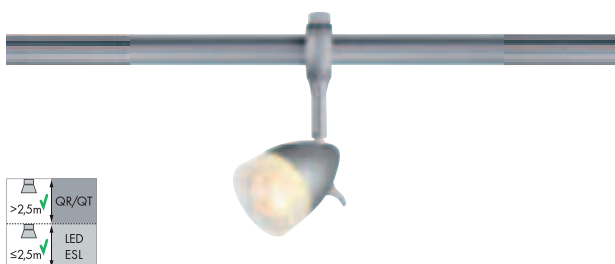

Socket/Bulb:
GU10/GU10 (excl.)
50W max.

Material:
Aluminium/glass

Dimensions:
Ø/L: 6,5/18 cm

Versions:
silver grey

Art. No.:
184071

Recommended bulb:
35W EnergySaver \approx 50W
20°, 2800K, 1200cd
575370



YANTI

230~ 350° 90° 0,28

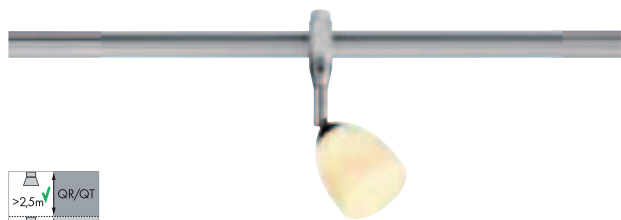
Socket/Bulb:
G9/G9 (excl.)
40W max.

Material:
Aluminium/ceramic

Dimensions:
Ø/L: 7/20 cm

Versions:
silver grey/white

Art. No.:
184152

Recommended bulb:
33W EnergySaver ≙ 40W
2700K, 460lm, EEK=C
519451

SWIFTEC Design by CDC/FGL

230~ 0,34

Socket/Bulb:
G9/G9 (excl.)
40W max.

Material:
Aluminium/glass

Dimensions:
Ø/L: 6/21 cm

Versions:
silver grey
Glass satined

Art. No.:
184282

Recommended bulb:
33W EnergySaver ≙ 40W
2700K, 460lm, EEK=C
519451

SWIFTEC PENDANT

230~ 1,5m 0,4

Socket/Bulb:
G9/G9 (excl.)
40W max.

Material:
Glass

Dimensions:
Glass-Ø/H: 6/10 cm

Versions:
Glass satined

Art. No.:
184372

Recommended bulb:
33W EnergySaver ≙ 40W
2700K, 460lm, EEK=C
519451

SAIL R7s Design by CDC/FGL

230~ 350° 0,7

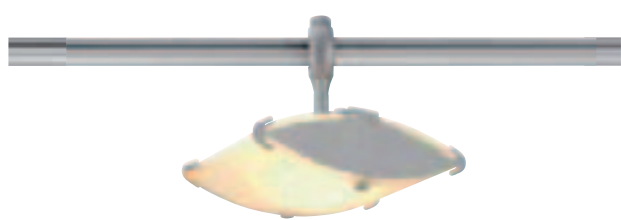
Socket/Bulb:
R7s/R7s, 78 mm (excl.)
100W max.

Material:
Steel/glass satined

Dimensions:
L/W/H: 20/15/16,5 cm

Versions:
Glass satined
silver grey

Art. No.:
184572

Recommended bulb:
100W EnergySaver ≙ 150W
2700K, 1900lm, EEK=C
519215

PIRUS

230~ 1,5m 0,53

Socket/Bulb:
E14/AGL Candle shape (excl.)
40W max.
or
E14/EnergySaver (excl.)
up to max. Ø/L: 3,8/11,7 cm

Material:
Steel/glass
Red textile-coated cable

Dimensions:
Head-Ø/H: 14/19 cm

Versions:
chrome

Art. No.:
184221

Recommended bulb:
11W, 2700K, 530lm, EEK=A
508810



LIGHT EYE PENDANT

230~

1,5m

0,7



Socket/Bulb:
GU10/ES111 (excl.)
75W max.

Material:
Steel
Black textile-coated cable

Dimensions:
Head-Ø/H: 15/14,5 cm

Versions:
chrome

Art. No.:
184592

Recommended bulb:
75W, 24°, 2700K, 2000cd
575672



Recommended bulb:
DomeLED 9W, 60°, 176lm
550392 warm white





BIBA 3

230~



Socket/Bulb:
E14/AGL (excl.)
60W max.
or
E14/EnergySaver (excl.)
up to max. Ø/H: 5/13 cm

Material:
Glass

Dimensions:
Glass-Ø/H: 13/26 cm

Versions:
silver grey/glass satined

Art. No.:
184521

Recommended bulb:
11W, 2700K, 530lm, EEK=A
508810



TONGA 1/4

230~

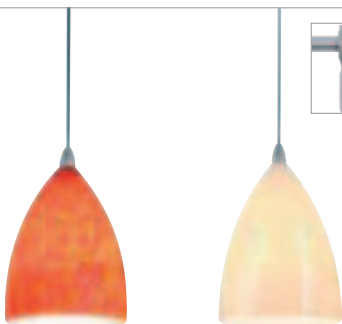

Socket/Bulb:
E14/AGL (excl.)
60W max.
or
E14/EnergySaver (excl.)
up to max. Ø/H: 5/13 cm

Material:
Tonga 1 Glass
Tonga 4 Ceramic

Dimensions:
Glass-Ø/H: 15/22 cm

Versions:
Tonga 1
Glass red/orange ▼
Tonga 4
Ceramic white

Art. No.:
184531
184534

Recommended bulb:
11W, 2700K, 530lm, EEK=A
508810



The illustrated lamp shade of the Tonga 1 is made of coloured hand blown glass. Each lamp is an unique whereby the marbling can vary.

1

4

BASIC COMPONENTS Easytec® II, silver grey

	<p>Track silver grey/1 pce. Aluminium L/W/H: 200/1/3 cm</p> <p>Art. No.: 184022</p> <p>2 silver grey end caps (incl.)</p>		<p>Feed-in silver grey/1 pce. Aluminium/glass L/W/H: 7,5/7,5/6 cm Cable-L: 40 cm</p> <p>Art. No.: 184002</p>
	<p>Ceiling suspension 10 cm silver grey/1 pce. L: 10 cm</p> <p>Art. No.: 184042</p>		<p>Ceiling suspension flexible silver grey/1 pce. L: adjustable 18-26 cm</p> <p>Art. No.: 184062</p>
	<p>Flexible suspension bracket silver grey/1 pce. For slanted ceilings. Joint: 180° Total-L: 23-31 cm</p> <p>Art. No.: 184332</p>		<p>Flexible wall bracket with guy rope silver grey/1 pce. L/W/H: 27/2,5/7 cm Adjustable from 15,5-24 cm Rope length: 40 cm</p> <p>Art. No.: 184312</p>
	<p>Longitudinal connector silver grey/1 pce.</p> <p>Art. No.: 184032</p>		<p>Insulating connector silver grey/1 pce.</p> <p>Art. No.: 184172</p> <p>For the use of 2 separate circuits.</p>
	<p>Flex connector silver grey/1 pce. L/W/H: 21,5/3/4 cm</p> <p>Art. No.: 184302</p>		<p>Pendant lamp adapter silver grey/1 pce. Load: 0,7 kg max. Product-L: 13 cm</p> <p>Art. No.: 184292</p> <p>Easy shortening of the pendant length.</p>
	<p>End caps silver grey/2 pce.</p> <p>Art. No.: 184142</p>		<p>Bending machine for radius-Ø: > 50 cm</p> <p>Art. No.: 184000</p>

LINUX LIGHT® CHROME

All lamps are equipped with a Linux Light®-adapter or Linux Light®- pendant lamp adapter.



LINUX LIGHT® SILVER GREY

All lamps are equipped with a Linux Light®-adapter or Linux Light®- pendant lamp adapter.

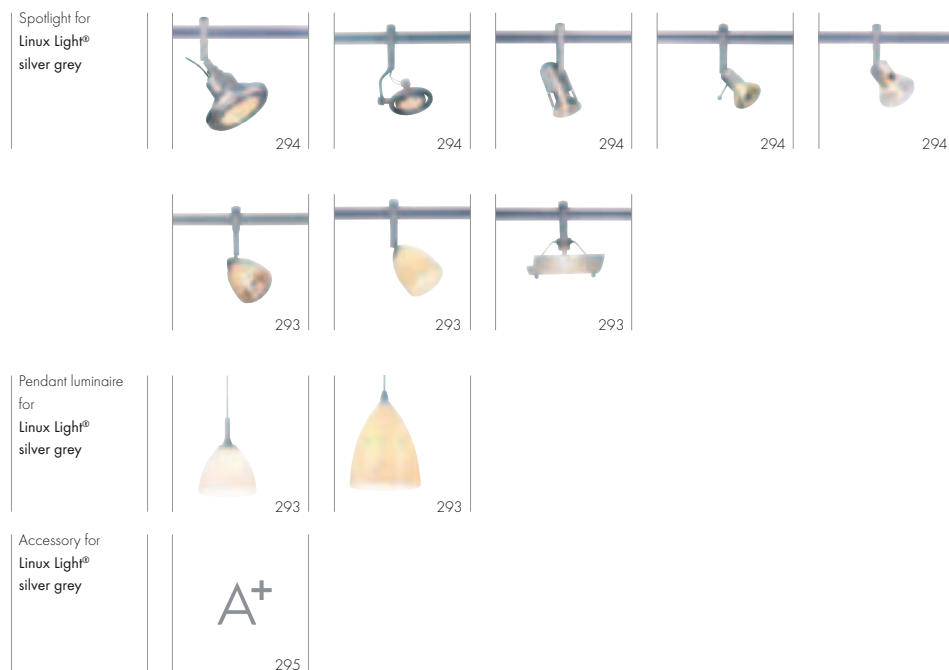

NONDRI

12~

Socket/Bulb:
 G6,35/pin socket (excl.)
 50W max.

Versions:
 chrome/white

Art. No.:
 136072

Material:
 Aluminium/ceramic

Dimensions:
 Ø/L: 7,5/22 cm

Recommended bulb:
 50W, 2700K, 900lm
 512250

ORION PENDANT

12~

Socket/Bulb:
 GY6,35/pin socket (excl.)
 50W max.

Versions:
 chrome/white satined

Art. No.:
 136201

Material:
 Glass

Dimensions:
 Shade-Ø/H: 12,5/9 cm

Recommended bulb:
 50W, 2700K, 900lm
 512250

DEWI

12~

Socket/Bulb:
 GY6,35/pin socket (excl.)
 50W max.

Versions:
 chrome/white

Art. No.:
 136375

Material:
 Ceramic

Dimensions:
 Shade-Ø/H: 9/10,5 cm

Recommended bulb:
 50W, 2700K, 900lm
 512250

LIGHT EYE SPOT MR16

 12~     

Socket/Bulb:
GU5,3/MR16 (excl.)
50W max.

Material:
Steel

Dimensions:
W/H: 10/18,5 cm
Head-Ø: 9 cm

Versions:
chrome

Art. No.:
136184

Recommended bulb:
50W, 2700K
535527 25°, 2450cd
535540 40°, 1500cd



Recommended bulb:
 PowerLED 4W
36°, 3000K, 500cd
560044

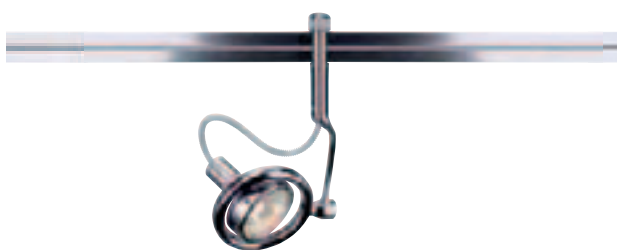

LIKA Design by CDC

 12~     

Socket/Bulb:
GX5,3/MR16 (excl.)
50W max.

Material:
Aluminium

Dimensions:
Ø/L: 8/15 cm

Versions:
chrome

Art. No.:
136372

Recommended bulb:
50W, 2700K
535527 25°, 2450cd
535540 40°, 1500cd



Recommended bulb:
 PowerLED 4W
36°, 3000K, 500cd
560044



ANILA

 12~     

Socket/Bulb:
GU5,3/MR16 (excl.)
50W max.

Material:
Aluminium/glass

Dimensions:
Ø/L: 7/21 cm

Versions:
chrome

Art. No.:
136174

Recommended bulb:
50W, 2700K
535527 25°, 2450cd
535540 40°, 1500cd

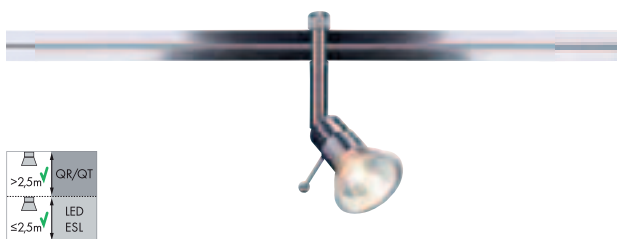

SYROS

 12~     

Socket/Bulb:
GU5,3/MR16 (excl.)
50W max.

Material:
Aluminium

Dimensions:
Ø/L: 5,5/15 cm

Versions:
chrome

Art. No.:
136212

Recommended bulb:
50W, 2700K
535527 25°, 2450cd
535540 40°, 1500cd

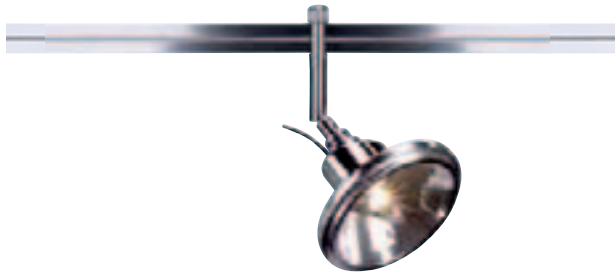

QRB SPOT

Socket/Bulb:
G53/QRB111 (excl.)
50W max.

Versions:
chrome

Art. No.:
136342

Material:
Aluminium

Dimensions:
Ø/L: 6/16,5 cm

Recommended bulb:
50W EnergySaver \neq 75W
24°, 3000K, 5800cd
545752

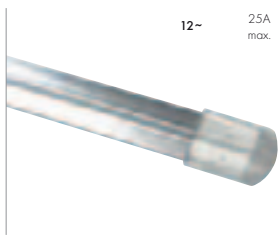
BASIC COMPONENTS for Linux Light® chrome

12~

 25A
max.

Track
chrome/1 pce.
Aluminium
2 clear end caps (incl.)
L/W/H: 200/2,3/0,5 cm
Bending machine (138200)
see page 295

Art. No.:
136222



Feed-in
25A max.
chrome/1 pce.
Ø/H: 3,7/2,9 cm
Cable-L: 60 cm

Art. No.:
136252

 230~
12~

 20-105
VA

Shortbox Transformer
20-105VA
chrome/1 pce.
Plastic
L/W/H: 18/5/10 cm
Max. track length: 2 m
Open circuit voltage: 11,5V
ta: 50°C, tc: 70°C
In case of a laterally protruding
of >75 cm, the ceiling suspension
10 cm (136246) is needed.
Further transformers can be found in
the accessory range.

Art. No.:
136192



Ceiling suspension
6,5 cm
chrome/1 pce.
Aluminium

Art. No.:
136240



Ceiling suspension
10 cm
chrome/1 pce.
Aluminium

Art. No.:
136246

Is suitable for Linux Light® Shortbox
transformer (136192).



Flex connector L
25A max.
chrome/1 pce.
Swivel range: 240°
Weight: 0,06 kg

Art. No.:
136402



Ceiling suspension
flexible
chrome/1 pce.
Aluminium
Product-L: 17,5-26 cm

Art. No.:
136260



Flex connector Y
25A max.
chrome/1 pce.
Swivel range: <45°
Weight: 0,17 kg

Art. No.:
▼ 136412

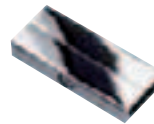

Longitudinal connector
25A max.
chrome/1 pce.

Art. No.:
136202



Flex connector X
25A max.
chrome/1 pce.
Swivel range: <60°
Weight: 0,21 kg

Art. No.:
▼ 136422

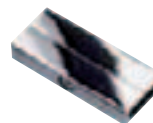

Insulating connector
chrome/1 pce.

Art. No.:
136232

For the use of 2 separate circuits.



Rope suspension
chrome/1 pce.
Pendant-L: 2,5 m

Art. No.:
136250

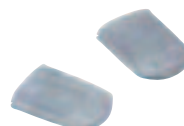

End caps
clear/2 pce.
Plastic

Art. No.:
138380



STRATOS

12~ 350° 90° 0,16

Socket/Bulb:
 GU5,3/MR16 (excl.)
 50W max.

Versions:
 silver grey
 Glass satined

Art. No.:
 138291

Material:
 Aluminium/glass

Dimensions:
 Ø/H: 6/15 cm

Recommended bulb:
 50W, 2700K
 535527 25°, 2450cd
 535540 40°, 1500cd

YANTI

12~ 350° 90° 0,21

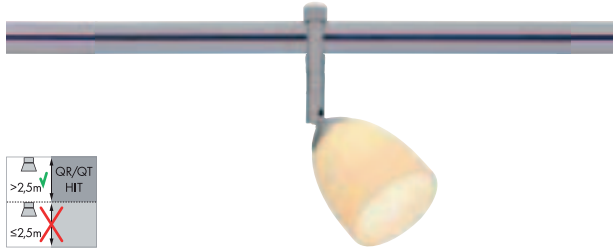
Socket/Bulb:
 GY6,35/pin socket (excl.)
 50W max.

Versions:
 silver grey
 white

Art. No.:
 138362

Material:
 Aluminium/ceramic

Dimensions:
 Ø/L: 7/17,5 cm

Recommended bulb:
 50W, 2700K, 900lm
 512250

SAIL

12~ 350° 0,17

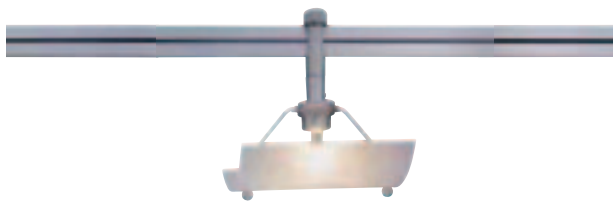
Socket/Bulb:
 GY6,35/pin socket (excl.)
 35W max.

Versions:
 silver grey
 Glass satined

Art. No.:
 138211

Material:
 Aluminium/glass

Dimensions:
 L/W/H: 12/8/6,5 cm

Recommended bulb:
 50W, 2700K, 900lm
 512250

ORION PENDANT

12~ 1,5 m 0,45

Socket/Bulb:
 GY6,35/pin socket (excl.)
 50W max.

Versions:
 silver grey
 white satined

Art. No.:
 138201

Material:
 Brass/glass

Dimensions:
 Shade-Ø/H: 12,5/9 cm

Recommended bulb:
 50W, 2700K, 900lm
 512250

TONGA 4

12~ 1,5 m 1,07

Socket/Bulb:
 GY6,35/pin socket (excl.)
 50W max.

Versions:
 Tonga 4, white

Art. No.:
 138144

Material:
 Brass/ceramic

Dimensions:
 Shade-Ø/H: 15/22 cm

Recommended bulb:
 50W, 2700K, 900lm
 512250

LIKA Design by CDC

12~

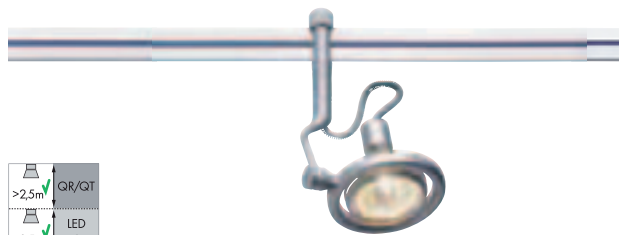

Socket/Bulb:
GX5,3/MR16 (excl.)
50W max.

Material:
Aluminium

Dimensions:
Ø/L: 8/15 cm

Versions:
silver grey

Art. No.:
138372

Recommended bulb:
50W, 2700K
535527 25°, 2450cd
535540 40°, 1500cd



SPACE

12~

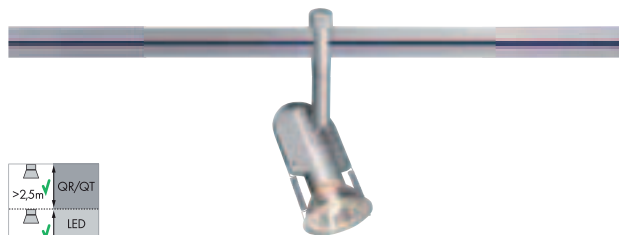

Socket/Bulb:
G5,3/MR16 (excl.)
50W max.

Material:
Aluminium

Dimensions:
L/W/H: 7,3/5/16,5 cm

Versions:
silver grey

Art. No.:
138322

Recommended bulb:
50W, 2700K
535527 25°, 2450cd
535540 40°, 1500cd



QRB SPOT

12~

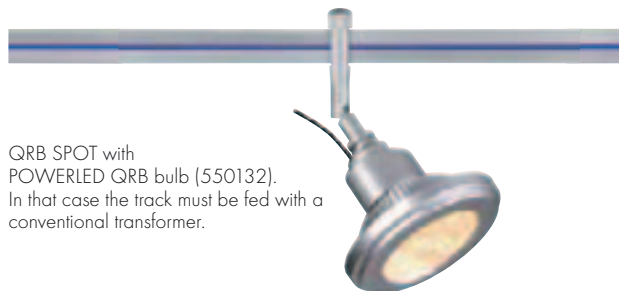

QRB SPOT with
POWERLED QRB bulb (550132).
In that case the track must be fed with a
conventional transformer.

Socket/Bulb:
G5,3/QRB111 (excl.)
50W max.

Material:
Aluminium

Dimensions:
Ø/L: 6/16,5 cm

Versions:
silver grey

Art. No.:
138342

Recommended bulb:
50W EnergySaver ≈ 75W
24°, 3000K, 5800cd
545752



SYROS

12~

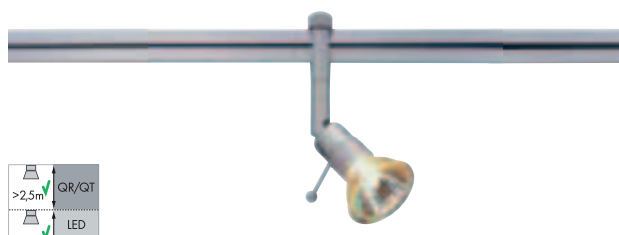

Socket/Bulb:
GX5,3/MR16 (excl.)
50W max.

Material:
Aluminium

Dimensions:
Ø/L: 5,5/15 cm

Versions:
silver grey

Art. No.:
138212

Recommended bulb:
50W, 2700K
535527 25°, 2450cd
535540 40°, 1500cd



ANILA

12~

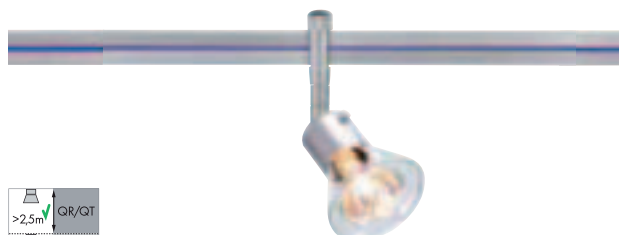

Socket/Bulb:
GU5,3/MR16 (excl.)
50W max.

Material:
Aluminium/Glass

Dimensions:
Ø/L: 7/21 cm

Versions:
silver grey
Glass clear

Art. No.:
138174

Recommended bulb:
50W, 2700K
535527 25°, 2450cd
535540 40°, 1500cd



BASIC COMPONENTS for Linux Light® silver grey

 <p>12~ 25A max. </p>	<p>Track Art. No.: silver grey/1 pce. 1 m 138221 Aluminium W/H: 2,3/0,5 cm 2 m 138222 2 end caps silver grey (incl.)</p>		<p>Feed-in Art. No.: 25A max. 138252 silver grey/1 pce. Ø/H: 3,7/2,9 cm Cable-L: 60 cm</p>
 <p>230~ 20-105 VA 12~ </p>	<p>Shortbox Transformer Art. No.: 20-105VA 138192 silver grey/1 pce. Plastic L/W/H: 18/5/10 cm Max. track length: 2 m Open circuit voltage: 11,5V ta: 50°C, tc: 70°C In case of a laterally protruding of >75 cm, the ceiling suspension 10 cm (138246) is needed. Further transformers can be found in the accessory range.</p>		<p>Ceiling suspension Art. No.: 6,5 cm 138240 silver grey/1 pce. Aluminium</p>
	<p>Ceiling suspension Art. No.: 10 cm 138246 silver grey/1 pce. Aluminium Suitable for Linux Light® Shortbox Transformer (138192).</p>		
	<p>Flex connector L Art. No.: 25A max. 138402 silver grey/1 pce. Swivel range: 240° Weight: 0,06 kg</p>		<p>Ceiling suspension Art. No.: 21 cm 138262 silver grey/1 pce. Aluminium</p>
	<p>Flex connector Y Art. No.: 25A max. ▼ 138412 silver grey/1 pce. Swivel range: <45° Weight: 0,17 kg</p>		<p>Ceiling suspension Art. No.: flexible 138260 silver grey/1 pce. Aluminium Product-L: 17,5-26 cm</p>
	<p>Flex connector X Art. No.: 25A max. ▼ 138422 silver grey/1 pce. Swivel range: <60° Weight: 0,21 kg</p>		<p>Longitudinal connector Art. No.: 25A max. 138202 silver grey/1 pce.</p>
	<p>Ceiling suspension Art. No.: for slanted ceilings 138432 flexible silver grey/1 pce. Aluminium Joint: 180° Product-L: 20-30 cm</p>		<p>Insulating connector Art. No.: silver grey/1 pce. 138232 For the use of 2 separate circuits.</p>
	<p>Wall bracket Art. No.: flexible 138270 silver grey/1 pce. Aluminium. Product-L: 12,5-21 cm</p>		<p>End caps Art. No.: silver grey/2 pce. 138280 Plastic</p>
	<p>Rope suspension Art. No.: silver grey/1 pce. 138250 Pendant-L: 2,5 m</p>		<p>Pendant lamp adapter Art. No.: silver grey/1 pce. 138522 Aluminium Product-L: 13 cm</p>
	<p>Bending machine Art. No.: 1 pce. ▼ 138200 for radius-Ø: > 40 cm</p>		

C-TRACK®

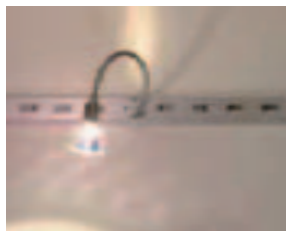

Here are some possible areas of application:





- Showcase interior lighting
- Mirror lighting
- Indirect lighting
- Illuminated picture holder track

The space-saving 12 volt track-system.

With the available modules, the user can very easily configure and assemble the C-Track®. In short time presentation areas and illuminations are installed in one process. The low voltage technology is up to date and with the usage of normal 12 volt output current completely safe.

Even in the narrowest areas a specific illumination is possible. With a rotation of 90° the C-Track® spotlights can simply be clipped into any desirable place of the shelf track. Three types of spotlights are available for the individual light arrangement.

KARDANIC SPOT

12~     



Socket/Bulb:
G5,3/MR16 (excl.)
35W max.

Material:
Aluminium/steel

Dimensions:
L/W/H: 6,5/3,3/3,3 cm





Versions:
silver grey

Art. No.:
188142

Recommended bulb:
 Philips PowerLED 4W
36°, 3000K, 500cd
560044



DABO SPOT

12~     



Socket/Bulb:
G5,3/MR16 (excl.)
20W

Material:
Aluminium

Dimensions:
L/W/H: 7/2,3/7 cm

Versions:
silver grey

Art. No.:
188152

Recommended bulb:
 Philips PowerLED 4W
36°, 3000K, 500cd
560044



GOOSE SPOT

12~   

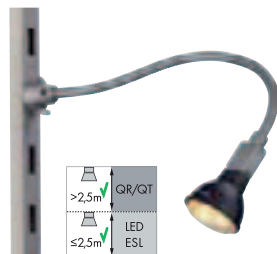
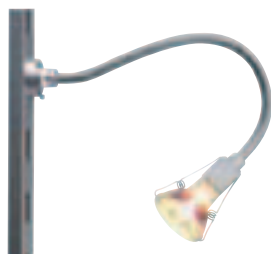

Socket/Bulb:
G4/MR11 (excl.)
35W max.

Material:
Steel

Dimensions:
L/W/H: 23,5/2,3/2,3 cm

Hinweis:
Only adjustable at gooseneck.

Versions:
silver grey

Art. No.:
188122

Recommended bulb:
 Philips PowerLED 4W
36°, 3000K, 590cd, RA80
560093



BASIC COMPONENTS for C-Track®

 <p>12- 20A max.</p>	 <p>Track 20A max. silver grey Aluminium L/W/H: 200/2,3/1 cm 2 end caps (incl.)</p> <p>Art. No.: 188022</p>		<p>Feed-in 20A max. silver grey/1 pce. L/W/H: 5,6/2,6/1,5 cm</p> <p>Art. No.: 188002</p>
	<p>Longitudinal connector 20A max. silver grey/1 pce. L/W/H: 4,3/2,3/1 cm</p> <p>Art. No.: 188162</p>		<p>Flex connector 20A max. silver grey/1 pce. L/W/H: 19/2,5/1,5 cm</p> <p>Art. No.: 188182</p>
	<p>Corner connector 20A max. silver grey/2 pce. L/W/H: 3,3/3,3/1 cm</p> <p>Art. No.: 188042</p>		<p>Rope shelf bracket silver grey/2 pce. Aluminium Rope-L: 1,2 m</p> <p>For fastening of shelves up to 30 cm width and max. 6 mm thickness. Mechanical load per rope: 12 kg.</p> <p>Art. No.: 188112</p>
	<p>Wall- and ceiling bracket silver grey/4 pce. W/H/T: 0,9/1,7/0,9 cm</p> <p>Art. No.: 188062</p>		<p>End caps silver grey/2 pce. L/W/H: 2/2,3/1 cm</p> <p>Art. No.: 188032</p>



GLU-TRAX®

ROBOT 2 slewable



Socket/Bulb:
G5,3/MR16 (excl.)
35W max.

Material:
Steel/plastic

Dimensions (without bulb):
W/H/T: 3/3/2,2 cm

Versions:
chrome

Art. No.:
186762

Recommended bulb:
 Philips PowerLED 4W
36°, 3000K, 500cd
560044



SOLO 90° slewable



Socket/Bulb:
G5,3/MR16 (excl.)
35W

Material:
Brass

Dimensions:
Head-Ø/H: 2,2/3 cm

Versions:
chrome

Art. No.:
186272

Recommended bulb:
 Philips PowerLED 4W
36°, 3000K, 500cd
560044



POWER-LED SPOT



Bulb:
PowerLED (incl.)
1W

Material:
Aluminium/PC

Dimensions:
Ø/H: 2,7/6,35 cm

Accessory/Included parts:
LED driver (incl.)

Hinweis:
Operate only with conventional transformer!

Versions:
silver grey
LED 6000K
LED 3000K

Art. No.:
186041
186042

BASIC COMPONENTS for GLU-TRAX®

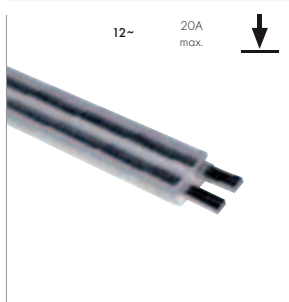

12~ 20A max.



Track 20A max. Art. No.: 186015
transparent
Plastic PC

L/W/H: 150/1/0,5 cm
Laying e.g. with double-sided adhesive tape, 3 m Art. No.: 220000



Mounting clips Art. No.: 186020
clear, 10er-Pack
Plastic PC
Ø/H: 1,7/0,8 cm

Max. distance of clips: 50 cm.
Max. mechanical load: 1 kg.

The clips are equipped with an adhesive surface for mounting on smooth surfaces as well as with a bore hole for screw joints. We recommend the fixation with a screw for wood.



Flexible longitudinal connector Art. No.: 186772
20A max. grey/1 pce.
L/W/H: 7,3/1,4/0,8 cm



Feed-in/longitudinal connector Art. No.: 186952
20A max. grey/1 pce.





MINI ALU TRACK

LED SPOT

12~



1pce.



320°



180°



45°



0,07



Bulb:
PowerLED (incl.)
1W

Material:
Aluminium/PC

Dimensions:
Ø/H: 2,3/4,5 cm

Accessory/Included parts:
LED driver (incl.)

Versions:
chrome
LED 6000K
LED 3000K

Art. No.:
186561
186562

BASIC COMPONENTS for Mini Alu-Track

12~



Mini Alu-Track
12,5A max.
chrome
Aluminium/PC
Art. No.:
186502

L/W/H: 100/1,1/0,85 cm
2 clear end caps (incl.)

Operate only with conventional transformer.

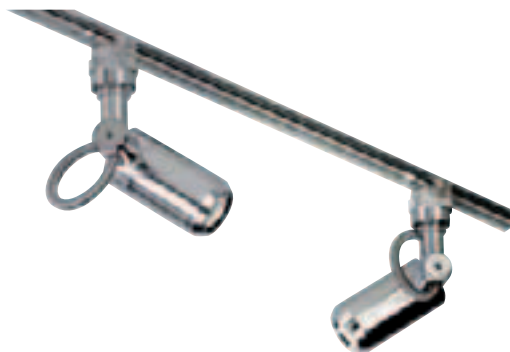

Feed-in
12,5A max.
chrome/1 pce.
Art. No.:
186512
L/W/H: 1,4/2,2/1,7 cm



Longitudinal connector
12,5A max.
chrome/1 pce.
L/W/H: 1,8/1,1/0,8 cm
Art. No.:
186522
For the electrical connection of two tracks (186502).



Feed-through for shelves
clear/2 pce.
acrylic
Ø/H: 2,2/1,3 cm
Art. No.:
186540



1,8



Mounting clips
clear, 10 pce.
Plastic PC
L/W/H: 2,5/1,5/1,1 cm
Art. No.:
186530

Track bracket with adhesive pad for mounting the track on glass surfaces and with a bore for screw mounting.





Apollo

SLEWABLE LAMP HOLDER



Socket/Bulb:
GX5,3/MR16; pin socket (excl.)
35W max.

Versions:
black/2 pce. Art. No.: 180080
white/2 pce. Art. No.: 180081
silver grey/2 pce. Art. No.: 180082



Recommended bulb:
COB LED 4,2W
60°, 2800K-3000K, 285lm
551312



BASIC COMPONENTS for Apollo low-voltage track



Electrical track transformer Art. No.:
black 182150
Plastic white 182151
silver grey 182152

L/W/H: 18,4/4,4/4,5 cm

Due to electromagnetic interferences, the maximum length of electronic transformers may not exceed 2 m!
When using the wall brackets (180160/-1) a feed-in (180060/-1/-2) is needed to operate the Apollo transformers (182150/-1/-2)!
Further transformer can be found in the accessory range.

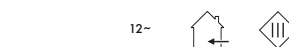
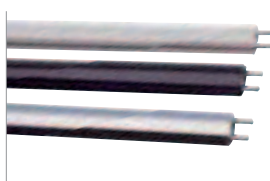

Track, 1 m Art. No.:
25A max. black 180000
Aluminium white 180001
2 pce. alu satin 180002
W/H: 1,6/1,2 cm

Track, 2 m Art. No.:
25A max. alu satin 180012
Aluminium
1 pce.
W/H: 1,6/1,2 cm



Feed-in Art. No.:
25A black 180060
1 pce. white 180061
L/W/H: silver grey 180062
11/2/1,8 cm
Cable-L: 60 cm



Flex connector Art. No.:
25A black 180030
1 pce. white 180031
L/W/H:
14,5/2/1,8 cm

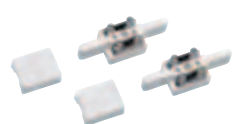

Longitudinal connector Art. No.:
25A black 180040
2 pce. white 180041
L/W/H: silver grey 180042
5,3/2/1,8 cm

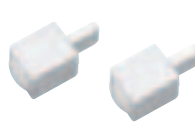

End caps Art. No.:
Plastic black 180050
2 pce. white 180051
L/W/H: silver grey 180052
3,6/1,6/1,8 cm



Wall bracket Art. No.:
Plastic black 180160
4 pce. white 180161

When using the wall brackets (180160/-1) a feed-in (180060/-1/-2) is needed to operate the Apollo transformers (182150/-1/-2)!





WAVE

The following illustrated lamps of the Wave track systems are always equipped with a wave adapter.

STAR

12~     



Socket/Bulb:
G5,3/MR16 (excl.)
50W max.

Material:
Aluminium/glass

Dimensions:
L/W/H: 12,5/6/13 cm

Versions:
Glass satined
chrome/white

Art. No.:
138881

Recommended bulb:
50W, 2700K
535527 25°, 2450cd
535540 40°, 1500cd



SPACE

12~     



Socket/Bulb:
G5,3/MR16 (excl.)
50W max.

Material:
Aluminium

Dimensions:
L/W/H: 12/8/6,5 cm

Versions:
chrome

Art. No.:
138832

Recommended bulb:
50W, 2700K
535527 25°, 2450cd
535540 40°, 1500cd



SYROS

12~     



Socket/Bulb:
G5,3/MR16 (excl.)
50W max.

Material:
Aluminium

Dimensions:
L/H: 7,4/13 cm

Versions:
chrome

Art. No.:
138842

Recommended bulb:
50W, 2700K
535527 25°, 2450cd
535540 40°, 1500cd



LIGHT TUBE Design by CDC

12~ 350° 0,25

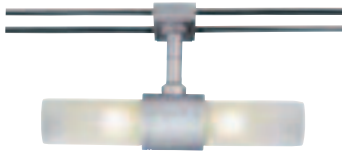
Socket/Bulb:
 G4/pin socket (excl.)
 2x 20W max.

Versions:
 Glass satined
 silver grey

Art. No.:
 138848

Material:
 Glass/aluminium

Dimensions:
 Ø/L/H: 4,2/20/10,5 cm

Recommended bulb:
 20W, 2700K, 330lm
 512220

QRB SPOT

12~ 350° 90° 0,15

Socket/Bulb:
 G53/QRB111 (excl.)
 50W max.

Versions:
 chrome

Art. No.:
 138882

Material:
 Aluminium

Dimensions:
 L/W: 13/6 cm

Recommended bulb:
 50W EnergySaver \approx 75W
 24°, 3000K, 5800cd
 545752

BIG SURA PENDANT

12~ 1,6 m 0,4

Socket/Bulb:
 G6,35/pin socket (excl.)
 50W max.

Versions:
 chrome/white

Art. No.:
 138871

Material:
 Ceramic/Brass, chrome-plated

Dimensions:
 Head-Ø/H: 9/9,5 cm

Recommended bulb:
 50W, 2700K, 900lm
 512250

Hinweis:
 The pendant length can be
 shortened at the adapter.

BASIC COMPONENTS for Wave

	12~ System rod 25A max. chrome/2 rods Ø/L: 0,6/70 cm Art. No.: 138800		Connector chrome/10 pce. Art. No.: 138809
	End caps silver grey/2 pce. For track width 3 cm Art. No.: 138807		Angle connector chrome/2 pce. Art. No.: 138803
	Cable feed-in 25A max. chrome/2 cables Product-L: 25 cm Art. No.: 138808		90°-Angle 25A max. chrome 85 mm, inside 138804 115 mm, outside 138805 For track width 3 cm.
	Suspension chrome/silver grey Product-L: 25 cm For track width 3 cm Base-Ø: 1 cm Length: adjustable 16-28 cm Art. No.: 138806		

LOW-VOLTAGE ROPE SYSTEM



ROPE LAMP QRB



Comet

ROPE LAMP QRB



Socket/Bulb:
G53/QRB111 (excl.)
50W max.

Versions:
chrome

Art. No.:
186462

Material:
Steel

Dimensions:
Head-Ø: 14 cm

Recommended bulb:
50W EnergySaver Æ 75W
24°, 3000K, 5800cd
545752



COMET



Socket/Bulb:
GU5,3/MR16 (excl.)
50W max.

Versions:
Glass partial satined
chrome

Art. No.:
139230

Material:
Aluminium/glass

Dimensions:
Ø/H: 6/13 cm

Recommended bulb:
50W, 25°, 2700K, 2450cd
535527





SPHERE WIRE

12~



10



0,25



Socket/Bulb:
GY6,35/pin socket (excl.)
20W max.

Material:
Aluminium/glass

Dimensions:
Ø/L: 9/12,5 cm

Versions:
chrome

Art. No.:
181176

Recommended bulb:
20W, 2700K, 330lm
512220



SAIL

12~



15



0,15



Socket/Bulb:
GY6,35/pin socket (excl.)
35W max.

Material:
Brass/glass

Dimensions:
L/W/H: 12/8/9,5 cm

Versions:
Glass satined
chrome

Art. No.:
181252

Recommended bulb:
35W, 2700K, 595lm
512235





SURA



Socket/Bulb:
GY6,35/pin socket (excl.)
50W max.

Material:
Brass/ceramic

Dimensions:
Head-Ø/W/H: 6,5/16,5/12 cm

Versions:
chrome
Shade white

Art. No.:
181232

Recommended bulb:
50W, 2700K, 900lm
512250



SURA PENDANT



Socket/Bulb:
GY6,35/pin socket (excl.)
50W max.

Material:
Brass/ceramic

Dimensions:
Head-Ø/W/H: 6,5/16,5/12 cm

Hinweis:
The pendant length can be
shortened at the adapter.

Versions:
chrome
Shade white

Art. No.:
181242

Recommended bulb:
50W, 2700K, 900lm
512250



SALUNA

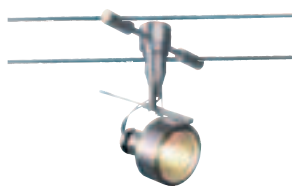
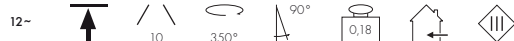

Socket/Bulb:
G5,3/MR16 (excl.)
35W max.

Material:
Aluminium

Dimensions:
Ø/H: 5,5/12,5 cm

Versions:
alu natural

Art. No.:
181180

Recommended bulb:
35W, 40°, 2700K, 810cd
535338



SYROS

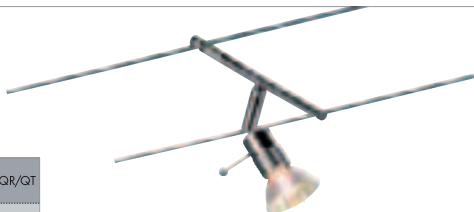
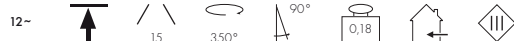

Socket/Bulb:
G5,3/MR16 (excl.)
50W max.

Material:
Aluminium

Dimensions:
Ø/L/W: 2,5/9/17 cm

Versions:
chrome

Art. No.:
181212

Recommended bulb:
50W, 25°, 2700K, 2450cd
535527



COSMIC LAMP HOLDER, SLEWABLE



Socket/Bulb:
GX5,3/MR16 (excl.)
35W max.

Versions:
black/2 pce.

Art. No.:
181080

Recommended bulb:
COB LED 4,2W
60°, 2800K-3000K, 285lm
551312



TELESKOP

12~



Socket/Bulb:
GX5,3/MR16 (excl.)
20W max.

Versions:
chrome

Art. No.:
186492

Dimensions:
Rod-L: 21-52 cm

Recommended bulb:
20W, 40°, 2700K, 450cd
535240

ROPE LAMP MR16

12~



Socket/Bulb:
GX5,3/MR16 (excl.)
20W max.

Versions:
black

Art. No.:
139162

Dimensions:
L: 60 cm

Recommended bulb:
COB LED 4,2W
60°, 2800K-3000K, 285lm
551312



BASIC COMPONENTS for low-voltage rope system

	<p>12~ </p> <p>Low-voltage rope 25A max. 20 m Art. No.: 139024 4 mm² isolated/1 roll 100 m 139004</p>		<p>Feed-in, 25A max. chrome/2 pce. Art. No.: 186352</p>
	<p>12~ </p> <p>Low-voltage rope 25A max. 20 m Art. No.: 139026 5 mm² isolated/1 roll 100 m 139006</p>		<p>Insulating connector chrome/2 pce. Art. No.: 186362 Product-L: 6 cm</p>
	<p>Wall bracket, short chrome/2 pce. Art. No.: 186302 Base-Ø/L: 5/3 cm Screws (incl.)</p>		<p>Wall bracket, middle chrome/2 pce. Art. No.: 186312 Base-Ø/L: 5/10 cm With clamping device. Screws (incl.)</p>
	<p>Deflector, short chrome/2 pce. Art. No.: 186332 Base-Ø/L: 5/6 cm Screws (incl.)</p>		<p>Deflector, long chrome/2 pce. Art. No.: 186342 Base-Ø/L: 5/16 cm Screws (incl.)</p>
	<p>Ceiling deflector chrome/2 pce. Art. No.: 186642 Base-Ø/L: 5/16,2 cm With deflector roll Screws (incl.)</p>		<p>Rope tightener chrome/2 pce. Art. No.: 181532 Product-L: 9-12,5 cm</p>

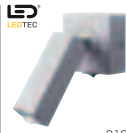

SPECIAL PRODUCTS

Special luminaires



312



314



314

Picture lights



311



311



311

Plug luminaires



315



315



315

Cupboard and mirror luminaires



316



316



317



317

Display luminaires



319



319



319



322



322

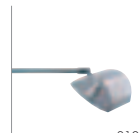

318

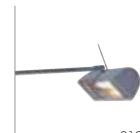

318



318



323



323



321



321



321



313



313

Floor cupboard luminaires



324



325



326



326



326



326



LED PICTURE LIGHT STRIP Design by CDC

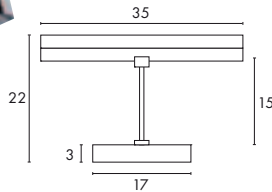
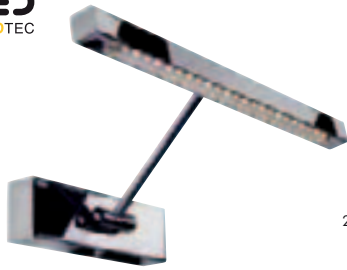

Bulb:
LED Strip (incl.)
2W

Material:
Steel

Dimensions:
W/H/D: 35/5,5/22 cm

Accessory/Included parts:
Power unit (incl.)

Versions:
chrome
LED 5300K
LED 3200K

antique brass
LED 5300K
LED 3200K

Art. No.:
146721
146722

146731
146732

Spring illumination of your exhibits through UV-free LED light without considerable heat emission.

PICTURE LIGHT 8W



Socket/Bulb:
G5/T5 EnergySaver (excl.)
8W

Material:
Steel

Dimensions:
W/H/D: 36/5,5/22 cm
Canopy-L/W/H: 17/3/5,5 cm
Rod-L: 13,5 cm

Accessory/Included parts:
Electronic ballast (incl.)

Versions:
chrome
antique brass

Recommended bulb:
8W, 4000K, 400lm
591294

Art. No.:
146572
146573

In the long term UV-light can damage sensitive exhibits. Please pay attention to the notes of the respective bulb manufacturers.

PICTURE LIGHT 13W



Socket/Bulb:
G5/T5 EnergySaver (excl.)
13W

Material:
Steel

Dimensions:
W/H/D: 59/5,5/22 cm
Canopy-L/W/H: 17/3/5,5 cm
Rod-L: 13,5 cm

Accessory/Included parts:
Electronic ballast (incl.)

Versions:
chrome
antique brass

Recommended bulb:
13W, 4000K, 880lm
591296

Art. No.:
146582
146583

In the long term UV-light can damage sensitive exhibits. Please pay attention to the notes of the respective bulb manufacturers.



STIX



Bulb:
PowerLED (incl.)
3W

Versions:
silver grey
LED 3000K
LED 6000K

Art. No.:
146272
146274

Material:
Aluminium

Dimensions:
L/W/D: 7/7/15,5 cm
Canopy-L/W/D: 7/7/3,5 cm

Accessory/Included parts:
LED driver (incl.)
Switch (incl.)

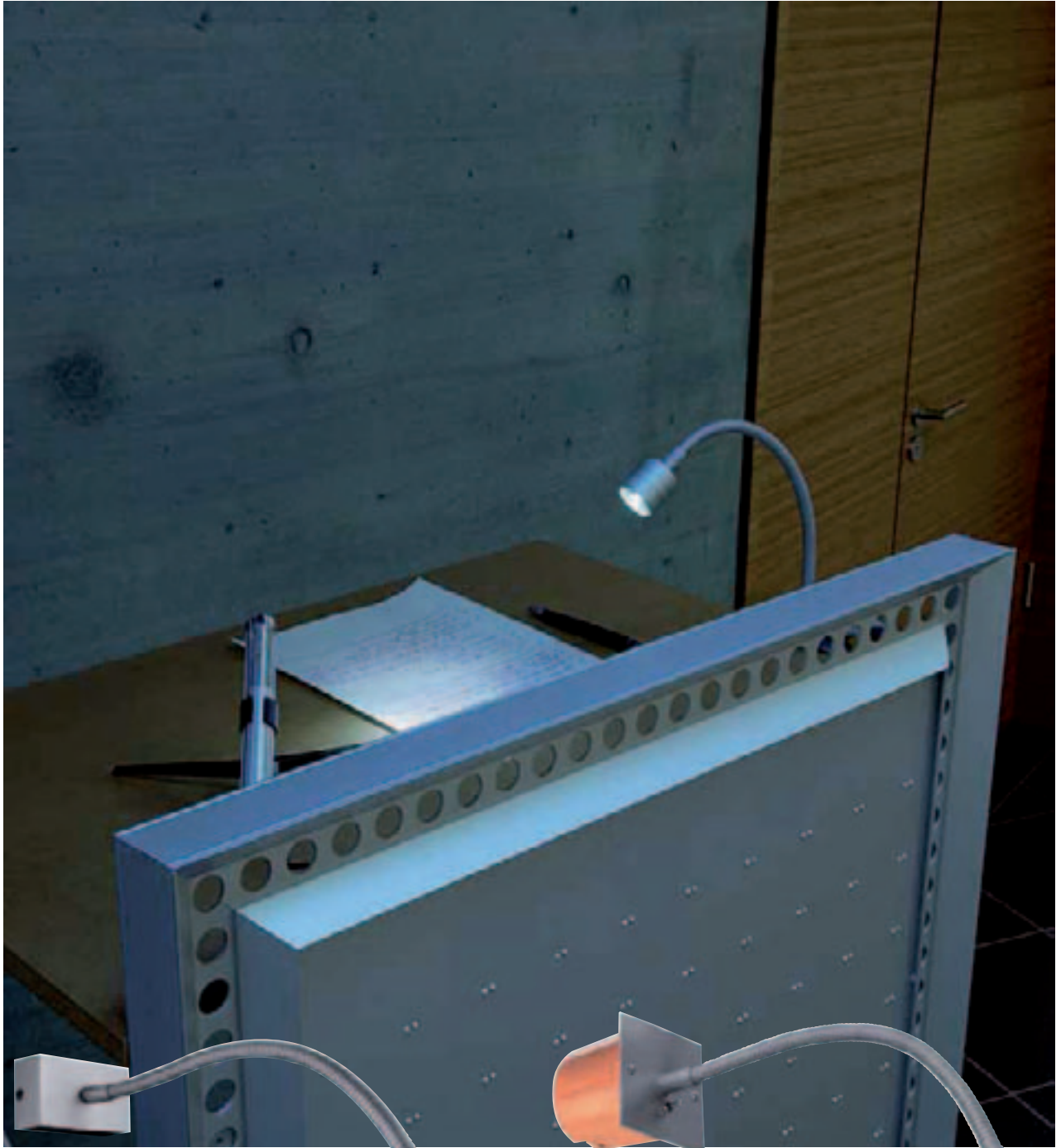

Individual adjustment of the lamp head through the flexible arm.

Individual adjustment of the lamp head through the flexible arm.

IVED GOOSE CANOPY Design by CDC 



Bulb:
PowerLED (incl.)
1W

Material:
Aluminium

Dimensions:
Head-H/Ø: 3,2/3,5 cm
L/W/H: 30/8/5 cm
Flexible arm-L: 24 cm
Canopy-W/H/D: 8/5/3 cm

Accessory/Included parts:
LED driver (incl.)

Versions:
silver grey
LED white
LED warm white

Art. No.:
146511
146512

IVED GOOSE RECESSED Design by CDC 



Bulb:
PowerLED (incl.)
1W

Material:
Aluminium

Dimensions:
Head-H/Ø: 3,2/3,5 cm
Flexible arm-L: 24 cm
Base: 9,5/9,5 cm

Accessory/Included parts:
Switch (incl.)
LED driver (incl.)
Flush-mounted box for masonry and cavity walls (incl.)

Versions:
silver grey
LED white
LED warm white

Art. No.:
146521
146522



Individual adjustment of the lamp head through the flexible arm.

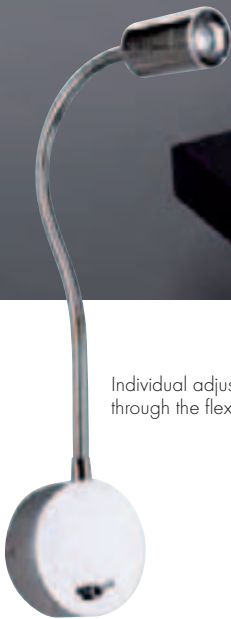

Individual adjustment of the lamp head through the flexible arm.

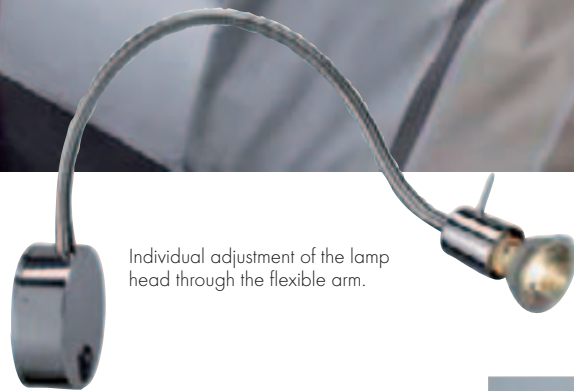

DIO FLEX PLATE LED Design by CDC



Bulb:
PowerLED (incl.)
1W

Versions:
chrome
LED 5300K
LED 3200K

Art. No.:
146612
146682

Material:
Aluminium

Dimensions:
Head-Ø/L: 3,2/3,5 cm
Flexible arm-L: 28,5 cm
Canopy-Ø/D: 9/3 cm
Total-L: 40 cm

Accessory/Included parts:
Switch (incl.)
LED driver (incl.)

DIO FLEX PLATE GU10 Design by CDC



Socket/Bulb:
GU10/GU10 (excl.)
50W max.

Versions:
chrome

Art. No.:
146692

Material:
Aluminium

Dimensions:
Head-Ø/L: 3,3/3,8 cm
Flexible arm-L: 40 cm
Canopy-Ø/D: 9/3,3 cm
Total-L: 40 cm

Recommended bulb:
35W EnergySaver ≈ 50W
20°, 2800K, 1200cd
575370



Recommended bulb:
COB LED, 5,6W
60°, 2700-3000K, 300lm
551332





DIO FLEX PLUG LED

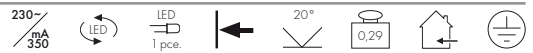

Individual adjustment of the lamp head through the flexible arm.



Bulb:
PowerLED (incl.)
1W

Material:
Aluminium/PC

Dimensions:
Total-L: 47,8 cm
Head-Ø/L: 3,5/6,4 cm
Flexible arm-L: 34,5 cm

Accessory/Included parts:
LED driver (incl.)

Versions:
chrome/white
LED 3200K

Art. No.:
146672

DIO FLEX PLUG for GX53



Individual adjustment of the lamp head through the flexible arm.



Socket/Bulb:
GX53/GX53 EnergySaver (excl.)
13W max.

Material:
Aluminium/PC

Dimensions:
Total-L: 54 cm
Head-Ø/H: 8,5/2,8 cm
Flexible arm-L: 34,5 cm

Versions:
chrome/white

Art. No.:
146622

Recommended bulb:
9W, 2700K, 260lm
508860



DIO FLEX PLUG for GU10



Individual adjustment of the lamp head through the flexible arm.



Socket/Bulb:
GU10/GU10 (excl.)
50W max.

Material:
Aluminium/PC

Dimensions:
Total-L: 44,5 cm
Head-Ø/L: 3,5/3,5 cm
Flexible arm-L: 34,5 cm

Versions:
chrome/white

Art. No.:
146632

Recommended bulb:
35W EnergySaver ≈ 50W
20°, 2800K, 1200cd
575370



Recommended bulb:
COB LED, 5,6W
60°, 2700-3000K, 300lm
551332





MIBO STRAIGHT

230~



IP21



Socket/Bulb:
G9/G9 (excl.)
2x 25W max.

Material:
Brass/glass

Dimensions:
Glass-Ø: 3,3 cm
W/D/H: 22/10/3,3 cm
Clamping range: 6,5 mm max.

Versions:
chrome
Glass partial satined

Art. No.:
146390

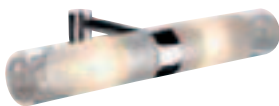

Recommended bulb:
20W EnergySaver ≈ 25W
2700K, 200lm, EEK=D
519450



MIBO CURVE

230~



IP21



Socket/Bulb:
G9/G9 (excl.)
2x 25W max.

Material:
Brass/glass

Dimensions:
Glass-Ø: 3,3 cm
W/H/D: 22/13/16 cm
Clamping range: 6,5 mm max.

Versions:
chrome
Glass partial satined

Art. No.:
146392



Recommended bulb:
20W EnergySaver ≈ 25W
2700K, 200lm, EEK=D
519450





DP 119 LED Surface mounted cupboard luminaire

350mA

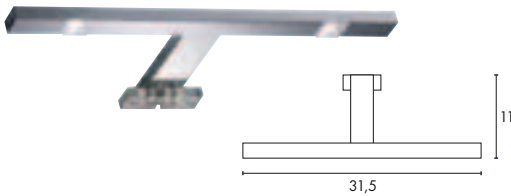

Bulb:
PowerLED (incl.)
2x 1W

Material:
Steel/plastic

Dimensions:
W/D/H: 31,5/11/2 cm
Supply line-L: 50 cm

Accessory/Included parts:
Switch (incl.)
LED driver (excl.)

Versions:
chrome
LED 6000K
LED 3000K

Art. No.:
146791
146792

Recommended connection:
LED driver 3W, 350mA
For 1 lamp
464108

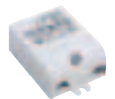

When connecting several cupboard luminaires, please pay attention to the total wattage! Further driver can be found in the accessory range.

ACCESSORY for DP 119 LED

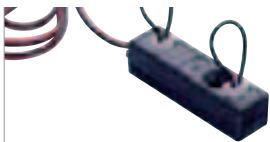

Connector strip
L/W/H: 5,2/1,4/1,3 cm
Supply line-L: 1 m
Series connection
3 outlets incl. 2 bridges

Art. No.:
111850



LED driver 12W, 350mA
For 3-4 lamps!

Art. No.:
464110

DP 118 R7s MIRROR LIGHT

230~ IP44

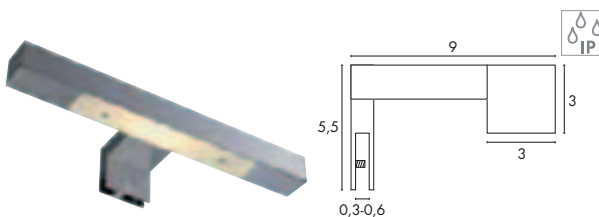

Socket/Bulb:
R7s/R7s, 78mm (excl.)
60W max.

Material:
Steel/glass

Dimensions:
W/D/H: 30/9/5,5 cm
Supply line-L: 50 cm

Accessory/Included parts:
Connection box (incl.)

Versions:
Glass satined
chrome

Art. No.:
146782

Recommended bulb:
60W, 660lm, EEK=E
519206



Suitable for walls with a material thickness of 3 to 6 mm.

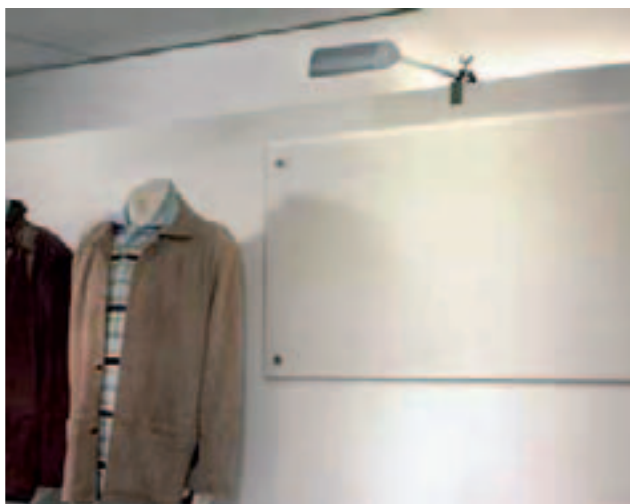

SDL DISPLAY Design by CDC

230~



Socket/Bulb:
R7s/R7s, 118 mm (excl.)
200W max.

Material:
Aluminium

Dimensions:
Head-L/W/H: 21/7,5/6,5 cm
Rod-L: 55 cm
Clamping range: 1,5-6 cm
Mains cable-L: 1,5 m

Accessory/Included parts:
Switch (incl.)

Versions:
silver grey/chrome

Art. No.:
146324

Recommended bulb:
100W EnergySaver \approx 150W
2700K, 1900lm, EEK=C
519221



NEPRO DISPLAY Design by CDC/FGL

230~



Socket/Bulb:
R7s/R7s, 118 mm (excl.)
300W max.

Material:
Aluminium

Dimensions:
Head-L/W/H: 17,5/11/6 cm
Rod-L: 52 cm
Clamping range: 1,5-5,5 cm
Mains cable-L: 1,5 m

Accessory/Included parts:
Plug (incl.)
Switch (incl.)
Tube kit (excl.)

Versions:
silver grey/chrome

Art. No.:
146472

Recommended bulb:
200W EnergySaver \approx 300W
2700K, 4000lm, EEK=C
519223



ACCESSORY for Nepro Display



Tube kit, two-part
For a simple fastening of the
Nepro Display on tubes or
trusses with a diameter of
32-42 mm.

Art. No.:
146479

SKELETTO

230~



Socket/Bulb:
R7s/R7s, 78 mm (excl.)
150W max.

Material:
Steel

Dimensions:
L/W/H: 77/16/11 cm
Head-L/W/H: 11/16/11 cm
Rod-L: 50 cm
Clamping range: 0,5-4,9 cm
Mains cable-L: 1,5 m

Accessory/Included parts:
Switch (incl.)

Versions:
silver grey

Art. No.:
170414

Recommended bulb:
100W EnergySaver \approx 150W
2700K, 1900lm, EEK=C
519215





DomeLED DISPLAY Design by CDC

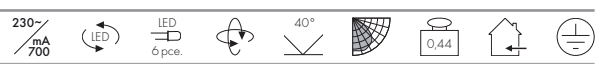

Bulb:
PowerLED (incl.)
6x 3W

Material:
Aluminium

Dimensions:
Product-Ø/L: 13,5/4 cm
Rod-L: 50 cm
Supply line-L: 1,5 m
Clamping range: 0,5-4,9 cm
Driver-L/W/H:
14/6,8/3,5 cm

Accessory/Included parts:
LED driver (incl.)
Switch (incl.)

Versions:
silver grey
LED white
LED warm white

Art. No.:

147351
147352

DISPLAY GX53



Socket/Bulb:
GX53/
GX53 EnergySaver 9W (incl.)
13W max.
or
PowerLED GX53, 3x 1,4W (excl.)
or
Shoplight GX53 11W (excl.)

Material:
Steel

Dimensions:
L/W/H: 60/9,5/10,5 cm
Head-Ø/H: 9,5/4,5 cm
Rod-L: 47 cm
Mains cable-L: 1,5 m
Clamping range-tube: 2-4,5 cm
Clamping range-wall: 1-4 cm

Accessory/Included parts:
Switch in mains cable (incl.)
Clamp (incl.)
Switch (incl.)
GX53 9W, 2700K (incl.)

Note:
Suitable for tube mounting.

Versions:
chrome ▼

Art. No.:
146592

Recommended bulb:
9W, 2700K, 260lm
508860



LED DISPLAY

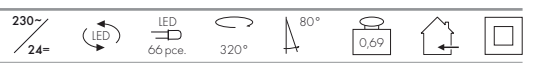

Bulb:
SMD LED (incl.)
16W total

Material:
Plastic/aluminium

Dimensions:
Head-W/H/D: 16,4/3,7/10,1 cm
Rod-L: 31,5 cm
Supply line-L: 2 m
Clamping range: 0,5-5,5 cm

Accessory/Included parts:
Power unit (incl.)
Switch (incl.)

Versions:
silver grey
LED white
LED warm white

Art. No.:

170401
170402



HIBIT Design by FGL

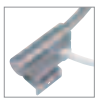
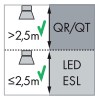
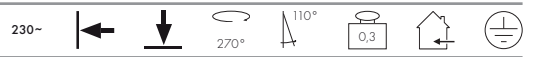

Socket/Bulb:
 GU10/GU10 (excl.)
 50W max.
 or ES111, 75W max. (excl.)
 or PAR20, 75W max. (excl.)

Material:
 Aluminium/brass

Dimensions:
 Head-Ø/H: 4,3/10 cm
 Rod-L: ca. 44 cm
 Cable-L: 60 cm

Accessory/Included parts:
 2 mounting brackets (incl.)
 Deco ring (excl.)

Versions:
 silver grey

Art. No.:
 146462

Recommended bulb:
 75W, 24°, 2700K, 2000cd
 575672



Recommended bulb:
 Philips PowerLED 6W
 25°, 3000K, 1100cd, 320lm
 560103



FILI with clamp Design by CDC

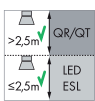

Socket/Bulb:
 GU10/GU10 (excl.)
 50W max.
 or ES111, 75W max. (excl.)
 or PAR20, 75W max. (excl.)

Material:
 Aluminium/brass

Dimensions:
 Head-Ø/H: 4,3/10 cm
 Rod-L: approx. 54 cm
 Clamping range: 8 cm max.

Accessory/Included parts:
 Deco ring (excl.)

Versions:
 silver grey

Art. No.:
 146452

Recommended bulb:
 75W, 24°, 2700K, 2000cd
 575672

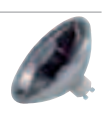

Recommended bulb:
 Philips PowerLED 6W
 25°, 3000K, 1100cd, 320lm
 560103



FILI with canopy Design by CDC

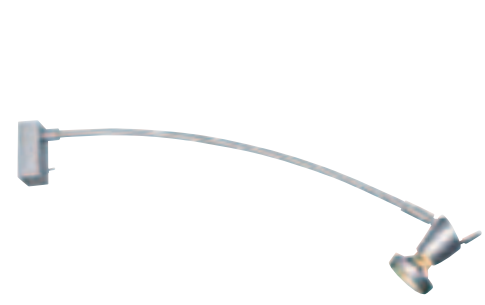

Socket/Bulb:
 GU10/GU10 (excl.)
 50W max.
 or ES111, 75W max. (excl.)
 or PAR20, 75W max. (excl.)

Material:
 Aluminium/brass

Dimensions:
 Head-Ø/H: 4,3/10 cm
 Rod-L: ca. 53 cm
 Canopy-L/W/H: 8/4,7/3 cm

Accessory/Included parts:
 Switch (incl.)
 Deco ring for GU10 (incl.)
 Deco ring for ES111 (excl.)

Versions:
 silver grey

Art. No.:
 146482

Recommended bulb:
 75W, 24°, 2700K, 2000cd
 575672



Recommended bulb:
 Philips PowerLED 6W
 25°, 3000K, 1100cd, 320lm
 560103



ACCESSORY for Fili and HIBIT

	<p>Deco ring 51 for GU10 silver grey, smooth</p> <p>Art. No.: 151050</p>		<p>Deco ring 111 for ES111 silver grey, grooved</p> <p>Art. No.: 151051</p>
--	--	--	---



NEAT FLEX PLATE



Socket/Bulb:
GU10/GU10 (excl.)
50W max.

Material:
Aluminium

Dimensions:
Ø/L: 8,5/36 cm

Accessory/Included parts:
Deco ring (incl.)

Versions:
silver grey

Art. No.:
146432

Recommended bulb:
35W EnergySaver \approx 50W
20°, 2800K, 1200cd
575370



Mounting on flush-mounted boxes with hole spacing 58 mm.
Individual adjustment of the lamp head through the flexible arm.

NEAT FLEX CLAMP



Socket/Bulb:
GU10/GU10 (excl.)
50W max.

Material:
Aluminium

Dimensions:
L/W/H: 40/7/2,5 cm
Mains cable-L: 1,8 m
Clamping range: 1,7-3,6 cm

Accessory/Included parts:
Switch in mains cable (incl.)
Switch (incl.)
Deco ring (incl.)

Versions:
silver grey

Art. No.:
146422

Recommended bulb:
35W EnergySaver \approx 50W
20°, 2800K, 1200cd
575370



Recommended bulb:
COB LED, 5,6W
60°, 2700-3000K, 300lm
551332



Individual adjustment of the lamp head through the flexible arm.

NEAT

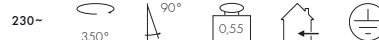

Socket/Bulb:
GU10/GU10 (excl.)
50W max.

Material:
Aluminium/brass

Dimensions:
L/W/H: 6/4/68 cm
Head-Ø/L: 4/6 cm
Rod-L: 50 cm
Mains cable-L: 1,5 m
Clamping range: 0,5-4,9 cm

Accessory/Included parts:
Switch (incl.)

Versions:
chrome
silver grey

Art. No.:
170422
170424

Recommended bulb:
35W EnergySaver \approx 50W
20°, 2800K, 1200cd
575370



Recommended bulb:
COB LED, 5,6W
60°, 2700-3000K, 300lm
551332



BIMA DISPLAY LIGHT

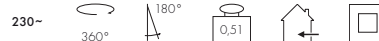

Socket/Bulb:
GU10/GU10 (excl.)
50W max.

Material:
Aluminium/steel

Dimensions:
L/W/H: 53/7,5/12 cm
Head-Ø/H: 6/8 cm
Rod-L: 44 cm
Clamping range-tube: 2-4,5 cm
Clamping range-wall: 1-4 cm
Mains cable-L: 1,5 m

Accessory/Included parts:
Switch (incl.)
Clamp (incl.)

Note:
Suitable for tube mounting e.g.
on truss systems.

Versions:
chrome

Art. No.:
146492

Recommended bulb:
35W EnergySaver \approx 50W
20°, 2800K, 1200cd
575370





DISPLAY ADL 50/GU10

230~

>2,5m	QR/QT
≤2,5m	LED ESL



Socket/Bulb:
GU10/GU10 (excl.)
50W max.

Versions:
chrome

Art. No.:
146332

Material:
Aluminium/brass

Dimensions:
Head-Ø/H: 3,5/9 cm
Supply line-L: 30 cm
Rod-L: ca. 46 cm

Recommended bulb:
35W EnergySaver ≠ 50W
20°, 2800K, 1200cd
575370



Accessory/Included parts:
Connection box (incl.)

Recommended accessory:
Deco ring, 51mm
chrome
151049



Recommended bulb:
COB LED, 5,6W
60°, 2700-3000K, 300lm
551332



DISPLAY ADL 50/MR16

12~

>2,5m	QR/QT
≤2,5m	LED ESL



Socket/Bulb:
GU5,3/MR16 (excl.)
50W max.

Versions:
chrome

Art. No.:
146312

Material:
Aluminium/brass

Dimensions:
Head-Ø/H: 3,5/6 cm
Supply line-L: 20 cm
Rod-L: approx. 37 cm

Recommended bulb:
50W, 40°, 2700K, 1500cd
535540



Accessory/Included parts:
Transformer (excl.)

Recommended accessory:
Deco ring, 51mm
chrome
151049





FURNITURE LED 65

230~

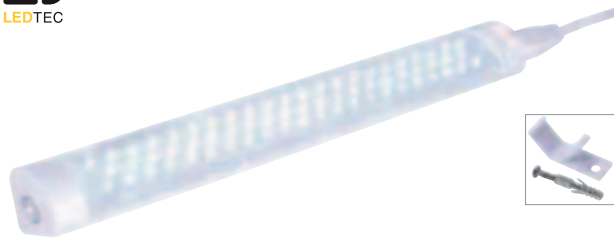

Bulb:
LED (incl.)
3,5W total

Material:
Plastic

Dimensions:
L/W/H: 33/3/3 cm
Mains cable-L: 1 m

Accessory/Included parts:
Euro flat plug (incl.)
Fastening accessories (incl.)
Switch at housing (incl.)

Versions:
white
LED 5300K
LED 3200K

Art. No.:
160311
160312

Direct connection of several lamps is possible with the integrated plug-in system.

FURNITURE LED 121

230~

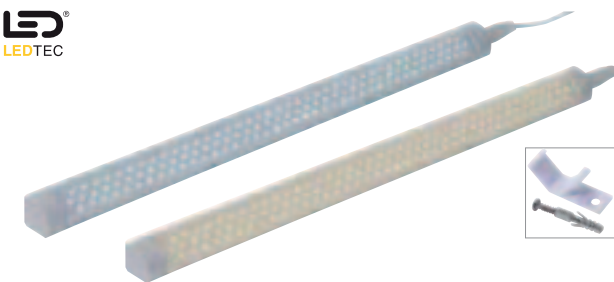

Bulb:
LED (incl.)
6W total

Material:
Plastic

Dimensions:
W/H/D: 55,5/3/3 cm
Mains cable-L: 1 m

Accessory/Included parts:
Euro flat plug (incl.)
Fastening accessories (incl.)
Switch at housing (incl.)

Versions:
white
LED 5300K
LED 3200K

Art. No.:
160301
160302

Direct connection of several lamps is possible with the integrated plug-in system

ACCESSORY for Furniture LED 65 / LED 121



Cable transits:
white
L: 53 cm
Up to 10 lamps can be connected
with each other.

Art. No.:
160321



Various mounting possibilities with the
included fastening clamps.



FURNITURE 513

230~

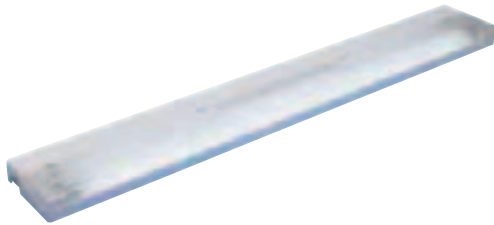

Socket/Bulb:
G5/T5 EnergySaver (excl.)
13W

Versions:
white

Art. No.:
160701

Material:
Plastic

Dimensions:
L/W/H: 56,2/8/3 cm
Supply line-L: 1,9 m

Recommended bulb:
591295 13W, 3000K, 880lm
591296 13W, 4000K, 880lm

(PU see page 661)

Accessory/Included parts:
Low-loss ballast (incl.)
Switch (incl.)

Connection of max. 10 lamps is possible.

ACCESSORY for Furniture 513



Connection cable:
Cable-L: 40 cm
Up to 10 lamps can be
connected with each other.

Art. No.:
160721



Connection plug:
Switch-L: 0,5 cm
Up to 10 lamps can be
connected with each other.

Art. No.:
160731



FURNITURE LED ROUND

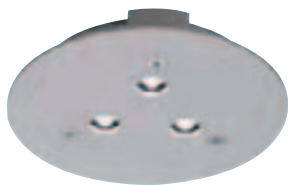

Bulb:
PowerLED (incl.)
3x 1W

Material:
Aluminium

Dimensions:
Ø/H: 7,5/1,2 cm
Supply line-L: 48 cm

Accessory/Included parts:
LED driver (excl.)

Versions:
silver grey
LED 6000K
LED 3000K

Art. No.:
111821
111822

Recommended connection:
LED driver 3W, 350mA
464108



When connecting several lamps, please take care of a series connection.

DL 123 LED FURNITURE

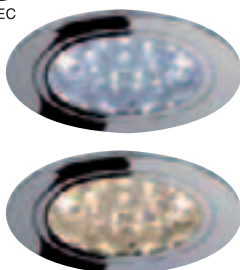
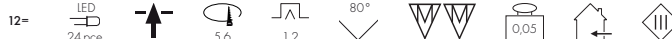

When connecting several lamps,
please pay attention to the total
wattage. Further power units can be
found in the accessory range.

Bulb:
SMD LED (incl.)
1,7W total

Material:
Aluminium

Dimensions:
Ø/H: 6,5/1,2 cm
Supply line-L: 1,2 m

Accessory/Included parts:
Power unit (excl.)

Versions:
chrome
LED 5500K, 113lm
LED 3000K, 92lm

Art. No.:
111951
111952

Recommended connection:
LED Power unit 12W, 12=
470507



DL 124/125 LED FURNITURE



Bulb:
SMD LED (incl.)
1,4W total

Material:
Plastic

Dimensions:
Ø/H: 7/1 cm
W/H/D: 7/1/7 cm
Supply line-L: 1 m

Accessory/Included parts:
Power unit (excl.)

Versions:
chrome/LED 3000K, 100lm
DL 124 (round) 112202
DL 125 (square) 112212

Art. No.:

Recommended connection:
LED Power unit 12W, 12=
470507



When connecting several lamps, please pay attention to the total wattage.
Further power units can be found in the accessory range.

FURNITURE TYP 3



Socket/Bulb:
G4/pin socket (excl.)
20W max.

Material:
Steel

Dimensions:
Ø/D: 6,6/3 cm

Accessory/Included parts:
Transformer (excl.)

Versions:
white
chrome

Art. No.:
116041
116042

Recommended bulb:
20W, 330lm, 2700K
512220





RECESSED LUMINAIRES

If the mounting pot of a respective product is included in the delivery, the stated mounting dimensions refer to the size of the mounting pot. The product dimensions always indicate the dimensions of the product without mounting pot. When connecting several lamps, please pay attention to the total wattage. Further drivers as well as transformers can be found in the accessory range.

<p>Aixlight® MOD MR16 MOD QRB111 MOD GU10 MOD ES111</p>	 334, 394	 334, 400	 335, 406	 335, 413			
<p>Aixlight® Flat QRB ES111</p>	 336	 336					
<p>Aixlight® Pro System Frame Module</p>	 Frameless: 341	 Frame: 341	 Frameless Round: 342	 Frame Round: 342	 Flat Frameless Round: 343	 Flat Frame Round: 343	 Module: 344-345
<p>Aixlight® Pro 50 System Frame Module</p>	 Frameless: 347	 Frame: 347	 Module: 347				

New Tria, square
MR16 / QRB111 /
GU10 / ES111 /
GX10 / G12



330, 394



331, 401



331, 406



331, 413

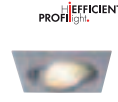

332, 428



332, 428

New Tria, round
MR16 / QRB111 /
GU10 / ES111 /
GX10 / G12 /
LED

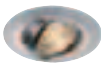

330, 387



331, 398

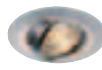

331, 405



331, 410

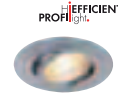

332, 428

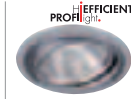

332, 428



332, 377

LED reading
luminaires



352

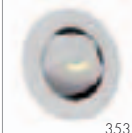

353

Luminaires for
grid ceilings



424



424

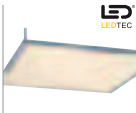

425

Recessed
luminaires
decorative



396



398



397



398

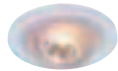

398



397



396



396



396



409

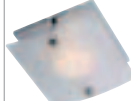

393



397



390



402



397



415

LED luminaires
compact



364



363



366



366



372



372



363



367



367



364

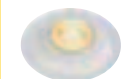

370



364

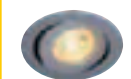

368



368, 374



372



372



373



373



365

Further recessed
luminaires,
slewable



387



387



387



388

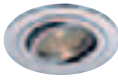

389

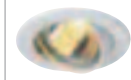

404

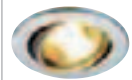

405



389



389



426



434, 435



434, 435



426

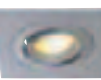

394, 408



390



409



393, 408

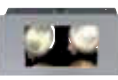











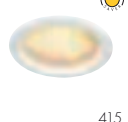
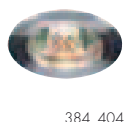
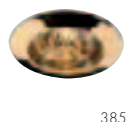

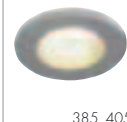

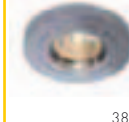









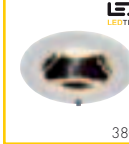



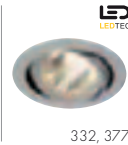



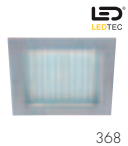





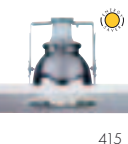







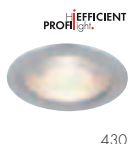
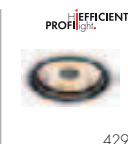

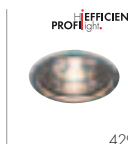





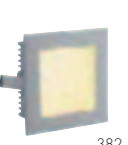
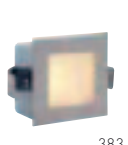

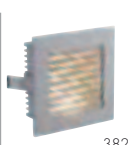
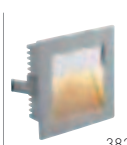
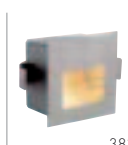

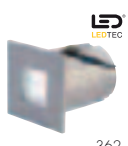
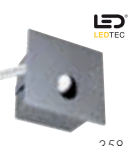
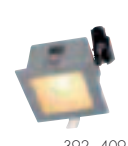

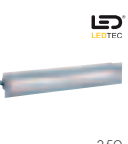

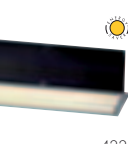
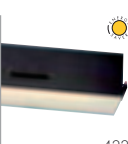
393



430



434, 435

Downlights, rigid construction							
							
Downlights							
							
							
							
							
							
Frames							
							
							
Downunder							
Downlight-Set							



NEW TRIA CEILING RECESSED LUMINAIRES

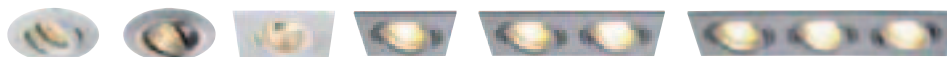

NEW TRIA MR16 low-voltage

12~



Material:
Aluminium

Note:
When connecting several lamps, please pay attention to the total wattage. Further transformers can be found in the accessory range.

Recommended bulb:
50W, 40°, 2700K, 1500cd
536540



Recommended connection:
Osram Mouse 105, 3.5-10.5VA
461105

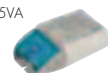

Accessory/Included parts:
Transformer (excl.)



Recommended bulb:
PowerLED 4W
36°, 3000K, 500cd, RA80+
560044



Article No.	Description	Colour	Voltage in AC	Socket/Bulb (excl.)	Wattage Bulb	Ø in cm	Length in cm	Width in cm	Height in cm	Installation dimensions in cm	Installation depth in cm	Rotation/Swivel range	Weight in kg	Price
111274	New Tria round MR16	alu brushed	12V	G5,3/MR16	50W max.	9,0	-	-	170	Ø 8,0	170	350°/45°	0,11	
113500	New Tria round MR16	matt white	12V	G5,3/MR16	50W max.	9,0	-	-	170	Ø 8,0	170	350°/45°	0,11	
111351	New Tria 1 MR16	alu brushed	12V	G5,3/MR16	50W max.	-	9,0	9,0	13,0	Ø 8,0	13,0	360°/30°	0,15	
113501	New Tria 1 MR16	matt white	12V	G5,3/MR16	50W max.	-	9,0	9,0	13,0	Ø 8,0	13,0	360°/30°	0,15	
111352	New Tria 2 MR16	alu brushed	12V	G5,3/MR16	2x 50W max.	-	17,0	9,0	13,0	16,0/8,2	13,0	360°/30°	0,30	
111353	New Tria 3 MR16	alu brushed	12V	G5,3/MR16	3x 50W max.	-	25,5	9,0	13,0	24,5/8,2	13,0	360°/30°	0,43	



NEW TRIA QRB111 low-voltage

12~



Material:
Aluminium

Note:
When connecting several lamps, please pay attention to the total wattage. Further transformers can be found in the accessory range.

Recommended bulb:
50W EnergySaver \neq 75W
545753 40°, 3000K, 2000cd



Recommended connection:
Osram Mouse 150, 50-150VA
461155

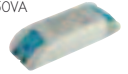

Accessory/Included parts:
Transformer (excl.)

Article No.	Description	Colour	Voltage in AC	Socket/Bulb (excl.)	Wattage Bulb	Ø in cm	Length in cm	Width in cm	Height in cm	Installation dimensions in cm	Installation depth in cm	Rotation/Swivel range	Weight in kg	Price
111370	New Tria round QRB111	alu brushed	12V	G53/QRB111	75W max.	16,5	-	-	12,5	Ø 15,0	12,5	360°/30°	0,23	
113530	New Tria round QRB111	matt white	12V	G53/QRB111	75W max.	16,5	-	-	12,5	Ø 15,0	12,5	360°/30°	0,23	
111371	New Tria 1 QRB111	alu brushed	12V	G53/QRB111	75W max.	-	16,5	16,5	12,5	Ø 15,0	12,5	360°/30°	0,35	
113531	New Tria 1 QRB111	matt white	12V	G53/QRB111	75W max.	-	16,5	16,5	12,5	Ø 15,0	12,5	360°/30°	0,35	
111372	New Tria 2 QRB111	alu brushed	12V	G53/QRB111	2x 75W max.	-	31,5	16,5	12,5	29,7/15,5	12,5	360°/30°	0,67	
111373	New Tria 3 QRB111	alu brushed	12V	G53/QRB111	3x 75W max.	-	46,5	16,5	12,5	45,0/15,5	12,5	360°/30°	0,72	

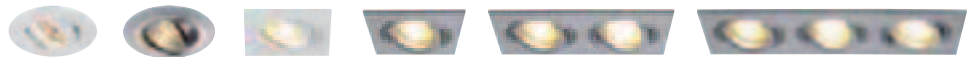

NEW TRIA GU10 high-voltage

230~



Material:
Aluminium

Recommended bulb:
35W EnergySaver \neq 50W
20°, 2800K, 1200cd
575370



Recommended bulb:
PHILIPS PowerLED 6W
40°, 3000K, 600cd, 320lm
560104



Article No.	Description	Colour	Voltage in AC	Socket/Bulb (excl.)	Wattage Bulb	Ø in cm	Length in cm	Width in cm	Height in cm	Installation dimensions in cm	Installation depth in cm	Rotation/Swivel range	Weight in kg	Price
111360	New Tria round GU10	alu brushed	230V	GU10/GU10	50W max.	9,0	-	-	17,0	Ø 8,0	17,0	360°/30°	0,15	
113510	New Tria round GU10	matt white	230V	GU10/GU10	50W max.	9,0	-	-	17,0	Ø 8,0	17,0	360°/30°	0,15	
111361	New Tria 1 GU10	alu brushed	230V	GU10/GU10	50W max.	-	9,0	9,0	12,5	Ø 8,0	17,0	360°/30°	0,20	
113511	New Tria 1 GU10	matt white	230V	GU10/GU10	50W max.	-	9,0	9,0	12,5	Ø 8,0	17,0	360°/30°	0,20	
111362	New Tria 2 GU10	alu brushed	230V	GU10/GU10	2x 50W max.	-	17,0	9,0	12,5	16,0/8,2	17,0	360°/30°	0,35	
111363	New Tria 3 GU10	alu brushed	230V	GU10/GU10	3x 50W max.	-	25,5	9,0	12,5	24,5/8,2	17,0	360°/30°	0,46	



NEW TRIA ES111 high-voltage

230~



Material:
Aluminium

Recommended bulb:
PowerLED 10W, 40°, 460lm
550352 warm white



Recommended bulb:
75W, 24°, 2700K, 2000cd
575672

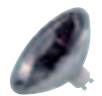

Article No.	Description	Colour	Voltage in AC	Socket/Bulb (excl.)	Wattage Bulb	Ø in cm	Length in cm	Width in cm	Height in cm	Installation dimensions in cm	Installation depth in cm	Rotation/Swivel range	Weight in kg	Price
111380	New Tria round ES111	alu brushed	230V	GU10/ES111	75W max.	16,5	-	-	12,5	Ø 15,0	12,5	360°/30°	0,33	
113540	New Tria round ES111	matt white	230V	GU10/ES111	75W max.	16,5	-	-	12,5	Ø 15,0	12,5	360°/30°	0,33	
111381	New Tria 1 ES111	alu brushed	230V	GU10/ES111	75W max.	-	16,5	16,5	12,5	Ø 15,0	12,5	360°/30°	0,38	
113541	New Tria 1 ES111	matt white	230V	GU10/ES111	75W max.	-	16,5	16,5	12,5	Ø 15,0	12,5	360°/30°	0,38	
111382	New Tria 2 ES111	alu brushed	230V	GU10/ES111	2x 75W max.	-	31,5	16,5	12,5	29,7/15,5	12,5	360°/30°	0,67	
111383	New Tria 3 ES111	alu brushed	230V	GU10/ES111	3x 75W max.	-	46,5	16,5	12,5	45,0/15,5	12,5	360°/30°	1,04	

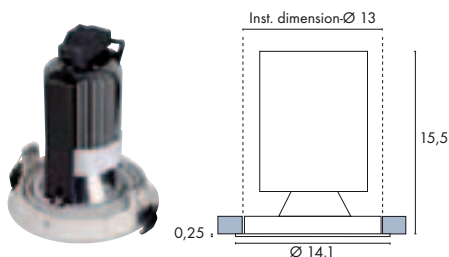

NEW TRIA LED DISK



Material:
Aluminium

Note:
PHILIPS Fortimo LED Disk Module
Suitable for cavity ceilings with a material thickness of max. 20 mm

Article No.	Description	Colour	Voltage in AC	Colour temperature in K	Luminous flux total	Ra	Socket/ Bulb (incl.)	Wattage Bulb	Ø in cm	Height in cm	Angle of radiation	Price
113581	New Tria LED Disk	matt white	230V	2700	630lm	90	PowerLED Module	14,5W	14,1	16,9	35°	
113584	New Tria LED Disk	silver grey	230V	2700	630lm	90	PowerLED Module	14,5W	14,1	16,9	35°	
113591	New Tria LED Disk	matt white	230V	2700	630lm	90	PowerLED Module	14,5W	14,1	16,9	60°	
113594	New Tria LED Disk	silver grey	230V	2700	630lm	90	PowerLED Module	14,5W	14,1	16,9	60°	
113561	New Tria LED Disk	matt white	230V	4000	630lm	80	PowerLED Module	15,2W	14,1	16,9	35°	
113564	New Tria LED Disk	silver grey	230V	4000	630lm	80	PowerLED Module	15,2W	14,1	16,9	35°	
113571	New Tria LED Disk	matt white	230V	4000	630lm	80	PowerLED Module	15,2W	14,1	16,9	60°	
113574	New Tria LED Disk	silver grey	230V	4000	630lm	80	PowerLED Module	15,2W	14,1	16,9	60°	



NEW TRIA GX10



Material:
Aluminium

Recommended bulb:
35W, 40°, 3000K, 3000cd
507340

Recommended connection:
Elec. ballast 35W, EEL=A2
470361

Accessory/Included parts:
Electronic ballast (excl.)

Note:
Further ballasts can be found in the accessory range.

Recommended connection:
Connection line HV
961062



Article No.	Description	Colour	Voltage	Socket/ Bulb (excl.)	Wattage Bulb	Ø in cm	Length in cm	Width in cm	Height in cm	Installation dimensions in cm	Installation depth in cm	Rotation/ Swivel range	Weight in kg	Price
111450	New Tria GX10 round	alu brushed	see E-ballast	GX10/CMH-MR16	20W/35W	9,0	-	-	10,0	Ø 8,0	12,5	360°/45°	0,15	
113520	New Tria GX10 round	matt white	see E-ballast	GX10/CMH-MR16	20W/35W	9,0	-	-	10,0	Ø 8,0	12,5	360°/45°	0,15	
111451	New Tria GX10 square	alu brushed	see E-ballast	GX10/CMH-MR16	20W/35W	-	9,0	9,0	10,0	Ø 8,0	12,5	360°/45°	0,15	
113521	New Tria GX10 square	matt white	see E-ballast	GX10/CMH-MR16	20W/35W	-	9,0	9,0	10,0	Ø 8,0	12,5	360°/45°	0,15	



NEW TRIA G12



Material:
Aluminium

Recommended bulb:
70W, 3000K, 6600lm
507130

Recommended connection:
Elec. ballast 70W, EEL=A2
470370

Accessory/Included parts:
Reflector, 38° (incl.)
Ballast (excl.)

Note:
max. ceiling thickness: 20 mm.
Further ballasts can be found in the accessory range.



Recommended bulb:
70W, 3000K, 7300lm
507430

Recommended connection:
Connection line HV
961062

Article No.	Description	Colour	Voltage	Socket/ Bulb (excl.)	Wattage Bulb	Ø in cm	Length in cm	Width in cm	Height in cm	Installation dimensions in cm	Installation depth in cm	Rotation/ Swivel range	Weight in kg	Price
111680	New Tria G12 round	alu brushed	see E-ballast	G12/HQI-T, CDM-T	35W/70W	16,5	-	-	20,0	Ø 15,5	22,0	360°/30°	0,36	
111681	New Tria G12 square	alu brushed	see E-ballast	G12/HQI-T, CDM-T	35W/70W	-	16,5	16,5	20,0	Ø 15,5	22,0	360°/30°	0,36	





AIXLIGHT® MOD

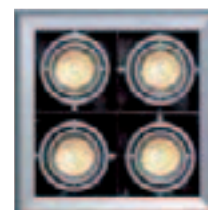
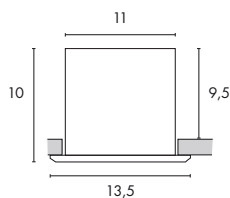

AIXLIGHT® MOD MR16 low-voltage



Material:
Aluminium/steel

Accessory/Included parts:
Transformer (excl.)

Recommended bulb:
COB LED 4,2W
60°, 2800-3000K, 285lm, RA80
551312



Recommended bulb:
50W, 40°, 2700K, 1500cd
536540



Article No.	Description	Colour	Voltage in AC	Socket/Bulb (excl.)	Wattage Bulb	Length in cm	Width in cm	Height in cm	Installation dimensions in cm	Installation depth in cm	Rotation/Swivel range	Weight in kg	Price
154112	Aixlight® Mod 1 MR16	silver grey	12V	GU5,3/MR16	50W max.	13,5	13,5	10,0	11,0/11,0	9,5	cardanic	0,40	
154122	Aixlight® Mod 2 MR16	silver grey	12V	GU5,3/MR16	2x 50W max.	24,0	13,5	10,0	22,0/11,0	9,5	cardanic	0,75	
154132	Aixlight® Mod 3 MR16	silver grey	12V	GU5,3/MR16	3x 50W max.	35,0	13,5	10,0	32,5/11,0	9,5	cardanic	1,10	
154142	Aixlight® Mod 4 MR16	silver grey	12V	GU5,3/MR16	4x 50W max.	23,0	23,0	10,0	20,0/20,0	9,5	cardanic	1,75	

When connecting several lamps, please pay attention to the total wattage. Suitable transformers can be found in the accessory range.



AIXLIGHT® MOD QRB111 low-voltage



Material:
Aluminium/steel

Accessory/Included parts:
Transformer (excl.)

Recommended bulb:
50W, 45°, 2700K, 700cd
543545



Recommended connection:
Osram Mouse 150, 50-150VA
461155

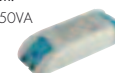

Article No.	Description	Colour	Voltage in AC	Socket/Bulb (excl.)	Wattage Bulb	Length in cm	Width in cm	Height in cm	Installation dimensions in cm	Installation depth in cm	Rotation/Swivel range	Weight in kg	Price
154012	Aixlight® Mod 1 QRB111	silver grey	12V	G53/QRB111	50W max.	20,5	20,5	10,0	16,5/16,5	9,5	cardanic	0,85	
154022	Aixlight® Mod 2 QRB111	silver grey	12V	G53/QRB111	2x 50W max.	39,0	20,5	10,0	34,5/17,0	9,5	cardanic	1,76	
154032	Aixlight® Mod 3 QRB111	silver grey	12V	G53/QRB111	3x 50W max.	52,0	20,5	10,0	49,0/17,0	9,5	cardanic	2,35	
154042	Aixlight® Mod 4 QRB111	silver grey	12V	G53/QRB111	4x 50W max.	36,0	36,0	10,0	33,0/33,0	9,5	cardanic	3,15	

When connecting several lamps, please pay attention to the total wattage. Further transformers can be found in the accessory range.

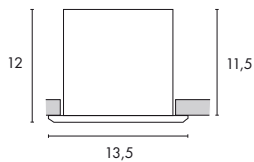
**AIXLIGHT® MOD GU10 high-voltage****Material:**
Aluminium/steel**Recommended bulb:**
35W EnergySaver \approx 50W
20°, 2800K, 1200cd
575370**Recommended bulb:**
PowerLED
40°, 3000K, 310cd, 220lm
560014

Article No.	Description	Colour	Voltage in AC	Socket/Bulb (excl.)	Wattage Bulb	Length in cm	Width in cm	Height in cm	Installation dimensions in cm	Installation depth in cm	Rotation/Swivel range	Weight in kg	Price
154552	Aixlight® Mod 1 GU10	silver grey	230V	GU10/GU10	50W max.	13,5	13,5	11,5	11,0/11,0	12,0	cardanic	0,62	
154562	Aixlight® Mod 2 GU10	silver grey	230V	GU10/GU10	2x 50W max.	28,5	13,5	11,5	26,0/11,0	12,0	cardanic	0,90	
154572	Aixlight® Mod 3 GU10	silver grey	230V	GU10/GU10	3x 50W max.	40,5	13,5	11,5	38,0/11,0	12,0	cardanic	1,60	
154582	Aixlight® Mod 4 GU10	silver grey	230V	GU10/GU10	4x 50W max.	23,0	23,0	11,5	20,0/20,0	12,0	cardanic	2,35	

**AIXLIGHT® MOD ES111 high-voltage****Material:**
Aluminium/steel**Recommended bulb:**
DomeLED 9W, 25°, 333lm
550382 warm white**Recommended bulb:**
75W, 24°, 2700K, 2000cd
575672

Article No.	Description	Colour	Voltage in AC	Socket/Bulb (excl.)	Wattage Bulb	Length in cm	Width in cm	Height in cm	Installation dimensions in cm	Installation depth in cm	Rotation/Swivel range	Weight in kg	Price
154052	Aixlight® Mod 1 ES111	silver grey	230V	GU10/ES111	75W max.	20,5	20,5	15,0	16,0/16,0	15,0	cardanic	1,05	
154062	Aixlight® Mod 2 ES111	silver grey	230V	GU10/ES111	2x 75W max.	39,0	20,5	15,0	35,5/17,0	15,0	cardanic	2,20	
154072	Aixlight® Mod 3 ES111	silver grey	230V	GU10/ES111	3x 75W max.	52,0	20,5	15,0	49,0/17,0	15,0	cardanic	2,85	
154082	Aixlight® Mod 4 ES111	silver grey	230V	GU10/ES111	4x 75W max.	36,0	36,0	15,0	32,0/32,0	15,0	cardanic	4,65	



AIXLIGHT® FLAT



QRB111 Single | 154622 |



QRB111 Double | 154632 |



ES111 Single | 154602 |



ES111 Double | 154612 |

AIXLIGHT® FLAT QRB111

Socket/Bulb:
G53/QRB111 (excl.)
50W max.

Material:
Steel

Accessory/Included parts:
Transformer (excl.)

Recommended bulb:
50W, 45°, 2700K, 700cd
543545



Recommended connection:
FN E-Transformer 02, 20-105VA
461107



AIXLIGHT® FLAT ES111

Socket/Bulb:
GU10/ES111 (excl.)
75W max.

Material:
Steel

Recommended bulb:
75W, 24°, 2700K, 2000cd
575672



Recommended bulb:
DomeLED 9W, 60°, 241lm
550391 warm white



AIXLIGHT® FLAT



Article No.	Description	Colour	Voltage in AC	Wattage Bulb	Length in cm	Width in cm	Height in cm	Installation dimensions in cm	Installation depth in cm	Material thickness installation surface in mm	Protection class	Weight in kg	Price
154622	Aixlight® Flat Single QRB111	chrome/matt black	12V	50W max.	20,5	20,5	9,5	170/170	9,5	10,0 - 24,0	III	0,95	
154632	Aixlight® Flat Double QRB111	chrome/matt black	12V	2x 50W max.	39,0	21,0	9,5	35,5/18,0	9,5	5,0 - 24,0	III	1,80	
154602	Aixlight® Flat Single ES111	chrome/matt black	230V	75W max.	20,5	20,5	15,0	170/170	15,0	10,0 - 24,0	I	1,25	
154612	Aixlight® Flat Double ES111	chrome/matt black	230V	2x 75W max.	39,0	21,0	15,5	35,5/18,0	15,0	5,0 - 24,0	I	2,25	





AIXLIGHT® PRO RECESSED SPOTLIGHT SYSTEM

1. Select an installation frame in the desired size/design/height with or without decoration cover.



4. For some modules a structure glass is optionally available.



2. Select the desired lamp module...



5. Select the operating units, suitable to the wattage of the bulb.



3. ... and the corresponding bulb.

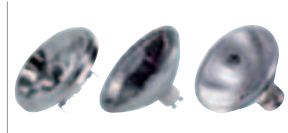

6. If you decided to use the G12 module, you need a suitable high-voltage connection line.

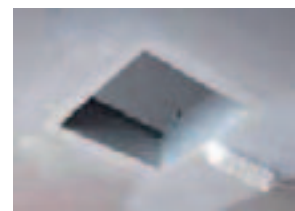
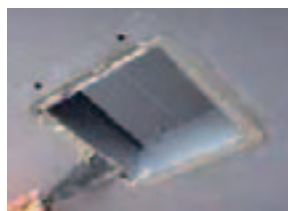
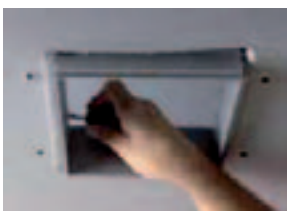
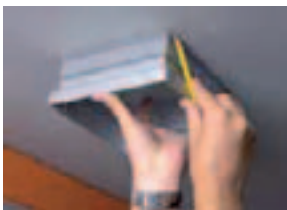







AIXLIGHT® PRO FRAME



AIXLIGHT® PRO FRAME installation frame Design by CDC

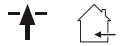

Material:
Steel

Note:
Professional, modular recessed ceiling system for cavity ceilings with a material thickness of 8-29 mm.
Suitable for all Aixlight® Pro Modules (further information on pages 344-345).

Article No.	Description	Colour	Length in cm	Width in cm	Height in cm	Installation dimensions in cm	Installation depth in cm	Material thickness installation surface	Weight in kg	Price
115104	Aixlight® Pro 1 Frame	silver grey/black	17,5	17,5	19,0	15,5/15,5	21,0	8,0 - 29,0 mm	1,00	
115114	Aixlight® Pro 2 Frame	silver grey/black	31,5	17,5	19,0	29,5/15,5	21,0	8,0 - 29,0 mm	1,45	
115124	Aixlight® Pro 3 Frame	silver grey/black	45,5	17,5	19,0	43,5/15,5	21,0	8,0 - 29,0 mm	1,82	

AIXLIGHT® PRO FRAMELESS

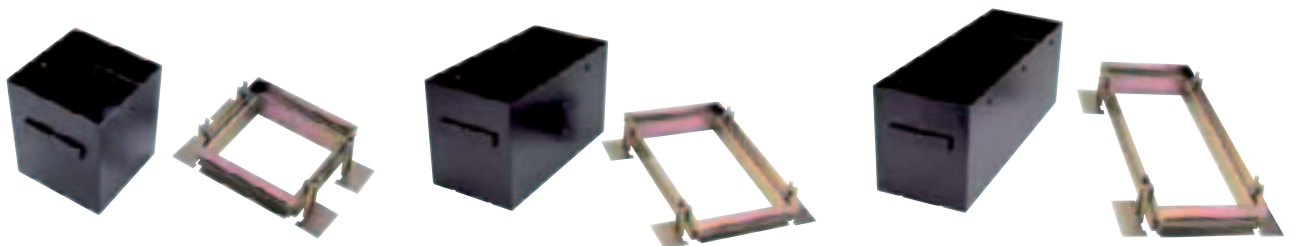

AIXLIGHT® PRO FRAMELESS installation frame Design by CDC



Material:
Steel

Note:
Professional, modular recessed ceiling system for cavity ceilings with a material thickness up to max. 20 mm.
Suitable for all Aixlight® Pro Modules (further information on pages 344-345).

Accessory/Included parts:
Installation frame (incl.)

Article No.	Description	Colour	Length in cm	Width in cm	Height in cm	Installation dimensions in cm	Installation depth in cm	Material thickness installation surface	Weight in kg	Price
115151	Aixlight® Pro 1 Frameless	black	15,5	15,5	18,5	19,0/19,0	23,0	max. 20,0 mm	2,15	
115152	Aixlight® Pro 2 Frameless	black	31,5	15,5	18,5	35,0/19,0	23,0	max 20,0 mm	3,50	
115153	Aixlight® Pro 3 Frameless	black	46,5	15,5	18,5	50,0/19,0	23,0	max 20,0 mm	4,80	



AIXLIGHT® PRO ROUND, HIGH CONSTRUCTION



AIXLIGHT® PRO FRAME ROUND installation frame Design by CDC



Material:
Steel

Note
Professional, modular recessed ceiling system for cavity ceilings with a material thickness up to max. 35 mm. Suitable for all Aixlight® Pro Modules (further information on pages 344-345).

Article No.	Description	Colour	Ø in cm	Length in cm	Width in cm	Height in cm	Installation dimensions in cm	Installation depth in cm	Material thickness installation surface	Weight in kg	Price
115641	Aixlight® Pro 1 Frame Round	matt white/black	17,5	-	-	18,5	Ø 15,5	20,0	8,0 - 35,0 mm	0,85	
115644	Aixlight® Pro 1 Frame Round	silver grey/black	17,5	-	-	18,5	Ø 15,5	20,0	8,0 - 35,0 mm	0,85	
115651	Aixlight® Pro 2 Frame Round	matt white/black	-	35,0	17,5	18,5	33,0/15,5	20,0	8,0 - 35,0 mm	1,50	
115654	Aixlight® Pro 2 Frame Round	silver grey/black	-	35,0	17,5	18,5	33,0/15,5	20,0	8,0 - 35,0 mm	1,50	



AIXLIGHT® PRO FRAMELESS ROUND installation frame Design by CDC



Material:
Steel

Note
Professional, modular recessed ceiling system for cavity ceilings with a material thickness up to max. 25 mm. Suitable for all Aixlight® Pro Modules (further information on pages 344-345).

Accessory/Included parts:
Installation frame (incl.)

Article No.	Description	Colour	Ø in cm	Length in cm	Width in cm	Height in cm	Installation dimensions in cm	Installation depth in cm	Material thickness installation surface	Weight in kg	Price
115674	Aixlight® Pro 1 Frameless Round	black	15,5	-	-	18,0	Ø 19,0	20,0	max. 25,0 mm	1,1	
115684	Aixlight® Pro 2 Frameless Round	black	-	32,5	15,5	18,0	36,0/19,0	20,0	max. 25,0 mm	2,7	



Application example:
Aixlight® Pro 2 Frameless Round (115674) with 2 QRB modules silver grey (115004) (bulb excl.)



Application example:
Aixlight® Pro 2 Frame Round (115651) with 1 QRB module white (115001) and 1 QRB module Move white (115071) (bulb excl.)



AIXLIGHT® PRO ROUND, FLAT CONSTRUCTION



AIXLIGHT® PRO FLAT FRAME ROUND installation frame Design by CDC

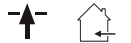

Material:
Steel

Note

The Aixelight® Pro variant for low installation depth. For cavity ceilings with a material thickness up to max. 35 mm. Only suitable with the below-mentioned lamp modules (details see pages 344).

Article No.	Description	Colour	Ø in cm	Length in cm	Width in cm	Height in cm	Installation dimensions in cm	Installation depth in cm	Material thickness installation surface	Weight in kg	Price
115601	Aixelight® Pro 1 Flat Frame Round	matt white/black	17,5	-	-	12,5	Ø 16,0	14,0	8,0 - 35,0 mm	0,5	
115604	Aixelight® Pro 1 Flat Frame Round	silver grey/black	17,5	-	-	12,5	Ø 16,0	14,0	8,0 - 35,0 mm	0,5	
115611	Aixelight® Pro 2 Flat Frame Round	matt white/black	-	35,0	17,5	12,5	33,0/15,5	14,0	8,0 - 35,0 mm	1,11	
115614	Aixelight® Pro 2 Flat Frame Round	silver grey/black	-	35,0	17,5	12,5	33,0/15,5	14,0	8,0 - 35,0 mm	1,11	



AIXLIGHT® PRO FLAT FRAMELESS ROUND installation frame Design by CDC



Material:
Steel

Note

The Aixelight® Pro variant for low installation depth. For cavity ceilings with a material thickness up to max. 25 mm. Only suitable with the below-mentioned lamp modules (details see pages 344).

Accessory/Included parts:
Installation frame (incl.)

Article No.	Description	Colour	Ø in cm	Length in cm	Width in cm	Height in cm	Installation dimensions in cm	Installation depth in cm	Material thickness installation surface	Weight in kg	Price
115624	Aixelight® Pro 1 Flat Frameless Round	black	15,5	-	-	12,0	Ø 19,0	14,0	25,0 mm	0,78	
115634	Aixelight® Pro 2 Flat Frameless Round	black	-	32,5	15,5	12,0	36,0/19,0	14,0	25,0 mm	1,72	

LAMP MODULES suitable for Flat installation frame. Further information see page 344



Article No.	Description	Colour	Voltage in AC	Socket/ Bulb (excl.)	Wattage Bulb	Ø in cm	Height in cm	Rotation/ Swivel range	Weight in kg	Protection class	Price
115001	QRB Module	matt white	12V	G53/QRB111	75W max.	13,5	6,0	cardanic	0,22	III	
115004	QRB Module	silver grey/black	12V	G53/QRB111	75W max.	13,5	6,0	cardanic	0,22	III	
115011	ES111 Module	matt white	230V	GU10/ES111	75W max.	13,5	11,5	cardanic	0,31	I	
115014	ES111 Module	silver grey/black	230V	GU10/ES111	75W max.	13,5	11,5	cardanic	0,31	I	



AIXLIGHT® PRO BULB-MODULE



QRB MODULE

matt white 115001
silver grey/black 115004

Material: Aluminium/plastic
Accessory/Included parts: Transformer (excl.)

Recommended bulb:
50W EnergySaver \approx 75W
545752 24°, 3000K, 5800cd
545753 40°, 3000K, 2000cd



Design by CDC
QRB MODULE MOVE

matt white 115071
silver grey/black 115074

Material: Aluminium/plastic
Accessory/Included parts: Transformer (excl.)
Note: Not suitable for flat installation frame.
Module can be pulled 5,5 cm out of the housing.

Recommended bulb:
50W EnergySaver \approx 75W
545752 24°, 3000K, 5800cd
545753 40°, 3000K, 2000cd



ES111 MODULE

matt white 115011
silver grey/black 115014

Material: Aluminium/plastic

Recommended bulb:
75W, 24°, 2700K, 2000cd
575672



E27 MODULE

silver grey/black 115034

Material: Aluminium/plastic
Note: Not suitable for flat installation frame.

Recommended bulb:
75W, 24°, 7000cd
519737



BULB-MODULE for Aixlight® Pro installation frame



Article No.	Description	Colour	Voltage in AC	Socket/Bulb (excl.)	Wattage Bulb	Ø in cm	Height in cm	Rotation/Swivel range	Weight in kg	Protection class	Price
115001	QRB Module	matt white	12V	G53/QRB111	75W max.	13,5	6,0	cardanic	0,22	III	
115004	QRB Module	silver grey/black	12V	G53/QRB111	75W max.	13,5	6,0	cardanic	0,22	III	
115071	QRB Module Move	matt white	12V	G53/QRB111	75W max.	13,5	170-22,5	180°/90°	0,42	III	
115074	QRB Module Move	silver grey/black	12V	G53/QRB111	75W max.	13,5	170-22,5	180°/90°	0,42	III	
115011	ES111 Module	matt white	230V	GU10/ES111	75W max.	13,5	11,5	cardanic	0,31	I	
115014	ES111 Module	silver grey/black	230V	GU10/ES111	75W max.	13,5	11,5	cardanic	0,31	I	
115034	E27 Module	silver grey/black	230V	E27/PAR30	75W max.	13,5	17,0	cardanic	0,46	I	





AIXLIGHT® PRO LAMP MODULES

PROFILIGHT
HiEFFICIENT

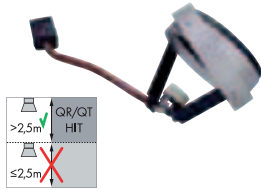

BRITESPOT ES111 MODULE

silver grey/black 115024 ▼

Material: Aluminium/plastic
Accessory/Included parts: Electronic ballast (excl.)
Note: Not suitable for flat installation frame. Suitable ballast and high-voltage connection line see below

Recommended bulb:
70W, 3000K, 20000cd
506982



PROFILIGHT
HiEFFICIENT

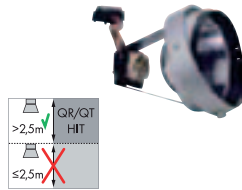

G12 MODULE

24° 115044
58° 11505
8° 115064

Material: Aluminium/plastic
Accessory/Included parts: Ballast (excl.)
Note: Not suitable for flat installation frame. Suitable ballast and high-voltage connection line see below

Recommended bulb:
70W, 3000K, 6600lm
507130



ENERGY
SAVER



Design by CDC ENERGYSAVER MODULE

silver grey/black 115094

Material: Aluminium/plastic
Note: Not suitable for flat installation frame. Suitable for bulbs with dimensions up to max. Ø/L: 5,3/14,0 cm.

Recommended bulb:
15W, 2700K, 800lm, EEK=A
508960



LED
TEC



Design by CDC LED DISK MODULE

2700K; matt white 115451
2700K; silver grey 115454
4000K; matt white 115461
4000K; silver grey 115464

Material: Aluminium/plastic
Angle of radiation: 50°
Note: Philips Fortimo LED Disk Module. Not suitable for flat installation frame.

LAMP MODULES for Aixlight® Pro installation frame

Article No.	Description	Colour	Voltage	Socket/ Bulb (excl.)	Wattage Bulb	Ø in cm	Height in cm	Rotation/ Swivel range	Weight in kg	Protection class	Price
115024 ▼	Britespot ES111 Module	silver grey/black	see E-ballast	GX10/Britespot ES111	35W/70W	13,5	11,5	cardanic	0,31	I	
115044	G12 Module 24°	silver grey/black	see E-ballast	G12/CDM-T; HQ/IT	35W/70W	13,5	15,0	cardanic	0,37	I	
115054	G12 Module 58°	silver grey/black	see E-ballast	G12/CDM-T; HQ/IT	35W/70W	13,5	15,0	cardanic	0,37	I	
115064	G12 Module 8°	silver grey/black	see E-ballast	G12/CDM-T; HQ/IT	35W/70W	13,5	15,0	cardanic	0,37	I	
115094	EnergySaver Module	silver grey/black	230V AC	E27/EnergySaver	21W	13,5	18,0	cardanic	0,43	I	

LED DISK MODULE for Aixlight® Pro installation frame

Article No.	Description	Colour	Voltage in AC	Colour temperature	Luminous flux total	Socket/ Bulb (incl.)	Wattage Bulb	Ø in cm	Height in cm	Weight in kg	Price
115451	LED Disk Module	matt white	230V	2700K	600lm	-/ Philips Fortimo LED Disk Module	14,5W	13,5	17,5	0,74	
115454	LED Disk Module	silver grey/black	230V	2700K	600lm	-/ Philips Fortimo LED Disk Module	14,5W	13,5	17,5	0,74	
115461	LED Disk Module	matt white	230V	4000K	600lm	-/ Philips Fortimo LED Disk Module	15,2W	13,5	17,5	0,74	
115464	LED Disk Module	silver grey/black	230V	4000K	600lm	-/ Philips Fortimo LED Disk Module	15,2W	13,5	17,5	0,74	

ACCESSORY for Aixlight® Pro lamp modules

	Structure glass not suitable for QRB- and LED Disk modules	Art. No.: 115170		Aluminium decoration cover matt white, to exchange the black standard cover.	Art. No.: 115600
	230~ Electronic ballast for HID-Bulb 35W, short-circuit proof. ta: 50°C, tc: 75°C	Art. No.: 470361		230~ Electronic ballast for HQI/CDM 70W, short-circuit proof. ta: 50°C, tc: 75°C	Art. No.: 470370
	Connection line HV Line-L: 2 m SO-2GMH2G-J 3x 1 mm ² Ignition voltage resistant up to max. 5KV. For HQI/CDM ballasts	Art. No.: 961062	When connecting several lamps, please pay attention to the total wattage. Further ballasts can be found in the accessory range.		



AIXLIGHT® PRO 50 recessed ceiling system

1. Select an installation frame with the desired size with or without decoration cover.

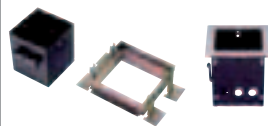

4. Select the operating units, suitable to the wattage of the bulb.



2. Select the desired lamp module...



5. If you decided to use the GX10 module, you need a suitable high-voltage connection line.



3. ... and the corresponding bulb.





AIXLIGHT® PRO 50 FRAME | FRAMELESS



AIXLIGHT® PRO 50 FRAME installation frame Design by CDC

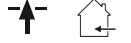

Material:
Steel

Note:
Professional, modular recessed ceiling system for cavity ceilings with a material thickness of 8-25 mm.
Suitable for all Aixlight® Pro 50 Modules (see below).

Article No.	Description	Colour	Length in cm	Width in cm	Height in cm	Installation dimensions in cm	Installation depth in cm	Material thickness installation surface in mm	Weight in kg	Price
115304	Aixlight® Pro 50 1 Frame	silver grey/black	10,0	10,0	10,0	8,5/8,5	13,0	8,0 - 25 mm	0,33	
115314	Aixlight® Pro 50 2 Frame	silver grey/black	17,3	10,0	10,0	16,0/8,5	13,0	8,0 - 25 mm	0,45	

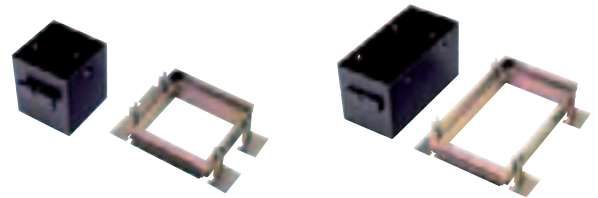

AIXLIGHT® PRO 50 FRAMELESS installation frame Design by CDC

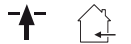

Material:
Steel

Note:
Professional, modular recessed ceiling system for cavity ceilings with a material thickness up to max. 18 mm.
Suitable for all Aixlight® Pro 50 Modules (see below).

Accessory/Included parts:
Installation frame (incl.)

Article No.	Description	Colour	Length in cm	Width in cm	Height in cm	Installation dimensions in cm	Installation depth in cm	Max. material thickness installation surface in mm	Weight in kg	Price
115351	Aixlight® Pro 50 1 Frameless	black	10,2	10,2	10,5	12,5/12,5	13,0	18	0,77	
115352	Aixlight® Pro 50 2 Frameless	black	18,8	10,2	10,5	21,0/12,5	13,0	18	1,09	



>2,5m QR/QT

≤2,5m LED ESL

MR16 MODULE

Material: Aluminium/plastic
Accessory/Included parts: Transformer (excl.)

Recommended bulb:
50W, 40°, 2700K, 1500cd
536540





>2,5m QR/QT

≤2,5m LED ESL

MR16 MODULE MOVE

Material: Aluminium/steel/plastic
Accessory/Included parts: Transformer (excl.)
Note: Module can be pulled 3 cm out of the housing.

Recommended bulb:
50W, 40°, 2700K, 1500cd
536540





>2,5m QR/QT

≤2,5m LED ESL

GU10 MODULE

Material: Aluminium/plastic

Recommended bulb:
35W EnergySaver ≠ 50W
20°, 2800K, 1200cd
575370





>2,5m QR/QT HIT

≤2,5m LED ESL

GX10 MODULE

Material: Aluminium/plastic
Accessory/Included parts: Electronic ballast (excl.)
Note: Suitable ballast and high-voltage connection line see page 345.

Recommended bulb:
35W, 40°, 3000K, 3000cd
507340



BULB-MODULE for Aixlight® Pro 50 installation frame



Article No.	Description	Colour	Voltage in AC	Socket/ Bulb (excl.)	Wattage Bulb	Ø in cm	Length in cm	Width in cm	Height in cm	Rotation/ Swivel range	Weight in kg	Protection class	Price
115404	MR16 Module	silver grey/black	12V	GU5,3/MR16	50W max.	7,0	-	-	2,5	cardanic	0,01	III	
115434	MR16 Module Move	silver grey/black	12V	GU5,3/MR16	50W max.	-	6,5	8,5	9,5	350°/45°	0,16	III	
115414	GU10 Module	silver grey/black	230V	GU10/GU10	50W max.	7,0	-	-	2,5	cardanic	0,01	II	
115424	GX10 Module	silver grey/black	-	GX10/CMH-MR16	20W/35W	7,0	-	-	2,5	cardanic	0,01	II	



HORN CEILING RECESSED LUMINAIRES

When connecting several lamps, please pay attention to the total wattage. Further driver and transformer options can be found in the accessory range.



HORN LED

alu 112882
white

Material: Aluminium
Accessory/Included parts: LED driver (excl.)

Recommended connection:
LED driver 6-12W, 700mA
464202



HORN LED COB 9W

white/white 160501
white/warm white 160502
silver grey/white 160511
silver grey/warm white 160512

Material: Plastic/aluminium
Accessory/Included parts: LED driver (excl.)
Note: Suitable for cavity ceilings with a material thickness of max. 15 mm.

Recommended connection:
LED driver 6-12W, 700mA
464202

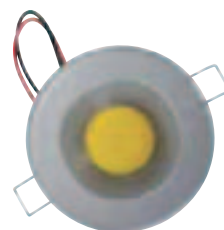

COB LEDs:

An increasing number of our products are equipped with the new COB (Chip On Board) LEDs. With this technology the LED-chips are mounted on conductor boards and connected by gold wires. The COB-technology allows the production of planar LEDs in various different constructions which consist of an aggregation of parallel switched single LEDs and provide a high light output whereas a major part of the developing heat is discharged via the conductor board. Planar LEDs with 15W for example provide a light yield which can be compared with a standard 75W incandescent lamp.

HORN LED



Article No.	Description	Colour	LED Colour	Luminous flux in lm	Power consumption	Socket/ Bulb (excl.)	Wattage Bulb	Number of LED	Ø in cm	Height in cm	Installation dimensions in cm	Installation depth in cm	Angle of radiation	Weight in kg	Price
112882	Horn LED	alu	3000K	230	700mA	-/PowerLED	3x3W	3 PowerLED	9,5	9,0	Ø 8,2	8,8	60°	0,17	
112892	Horn LED	white	3000K	250	700mA	-/PowerLED	3x3W	3 PowerLED	9,5	9,0	Ø 8,2	8,8	60°	0,17	
160501	Horn LED COB 9W	white	5300K	563	700mA	-/COB LED	9W	1 Planar LED	9,5	8,6	Ø 8,2	9,2	-	0,20	
160502	Horn LED COB 9W	white	3200K	556	700mA	-/COB LED	9W	1 Planar LED	9,5	8,6	Ø 8,2	9,2	-	0,20	
160511	Horn LED COB 9W	silver grey	5300K	563	700mA	-/COB LED	9W	1 Planar LED	9,5	8,6	Ø 8,2	9,2	-	0,20	
160512	Horn LED COB 9W	silver grey	3200K	556	700mA	-/COB LED	9W	1 Planar LED	9,5	8,6	Ø 8,2	9,2	-	0,20	





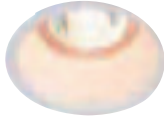

HORN MR16

white 112901

Material: Steel

Accessory/Included parts: Transformer (excl.)

Recommended bulb:

50W, 40°, 2700K, 1500cd
536540



Recommended connection:

FN E-Transformer 02, 20-105VA
461107



HORN 2 TURNO MR16

matt white 113101

Material: Steel

Accessory/Included parts: Transformer (excl.)

Recommended bulb:

50W, 40°, 2700K, 1500cd
536540



Recommended connection:

FN E-Transformer 02
20-105VA
461107



HORN QRB111

white 112931

Material: Steel

Accessory/Included parts: Transformer (excl.)

Recommended bulb:

50W EnergySaver \approx 75W
545752, 24°, 3000K, 5800cd
545753, 40°, 3000K, 2000cd



Recommended connection:

FN E-Transformer 02, 20-105VA
461107



HORN low-voltage

12~



Article No.	Description	Colour	Voltage in AC	Socket/Bulb (excl.)	max. Wattage Bulb	Ø in cm	Length in cm	Width in cm	Height in cm	Installation dimensions in cm	Installation depth in cm	Rotation/Swivel range	Weight in kg	Price
112901	Horn MR16	white	12V	G5,3/MR16	50W	8,3	-	-	11,5	Ø 7,5	11,5	-	0,12	
113101	Horn MR16 2 adjust	matt white	12V	G5,3/2x MR16	2x50W	-	18,3	11,3	10,0	172/10,2	11,0	350°/60°	0,31	
112931	Horn QRB111	white	12V	G53/QRB111	75W	17,2	-	-	12,5	Ø 16,2	12,5	-	0,3	

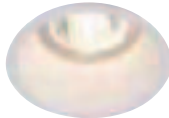

HORN GU10

white 112911

Material: Steel

Recommended bulb:

35W EnergySaver \approx 50W
20°, 2800K, 1200cd
575370



Recommended bulb:

PowerLED, 6W dimmable
40°, 3000K, 600cd, 320lm
560104



HORN 2 TURNO GU10

matt white 113111

Material: Steel

Recommended bulb:

35W EnergySaver \approx 50W
20°, 2800K, 1200cd
575370



Recommended bulb:

PowerLED, 6W dimmable
40°, 3000K, 600cd, 320lm
560104



HORN ES111

white 112921

Material: Steel

Recommended bulb:

75W, 24°, 2700K, 2000cd
575672



HORN high-voltage

230~



Article No.	Description	Colour	Voltage in AC	Socket/Bulb (excl.)	Wattage Bulb	Ø in cm	Length in cm	Width in cm	Height in cm	Installation dimensions in cm	Installation depth in cm	Rotation/Swivel range	Weight in kg	Price
112911	Horn GU10	white	230V	GU10/GU10	50W max.	8,3	-	-	11,5	Ø 7,5	11,5	-	0,13	
113111	Horn GU10 2 adjust	matt white	230V	GU10/2x GU10	2x50W max.	-	18,3	11,3	10,0	172/10,2	11,0	350°/60°	0,35	
112921	Horn ES111	white	230V	GU10/ES111	75W max.	17,2	-	-	12,5	Ø 16,2	12,5	-	0,30	

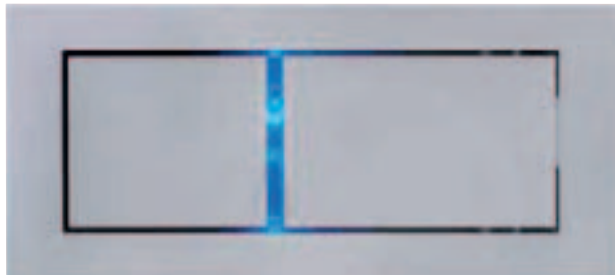

Bedside left



Bedside right

BEDSIDE left/right

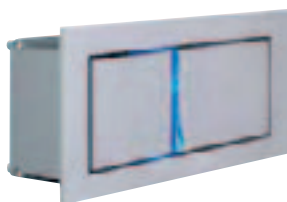

Bulb:
PowerLED (incl.)
3W
and
LED (incl.)
0,06W
Closed current, 10mA

Material:
Aluminium

Dimensions:
W/H/D: 18,5/8,2/5,3 cm

Accessory/Included parts:
Cavity wall fitting clamp (incl.)
LED driver (excl.)

Note:
The main LED is switched on with the push-lock-system. Integrated blue LED light in closed position. The blue orientation light can be switched-off completely via a switch on the back side before mounting the lamp. Not suitable for series connection. Therefore only operable with 3W LED driver (464200).

Versions:
silver grey
LED 6000K/blue
left
right

LED 3000K/blue
left
right

Art. No.:

146244
146254

146242
146252

Recommended accessory:

Flush-mounted box for installation in masonry walls.
W/H/D: 17,3/13/8 cm
146260



Recommended connection:

LED driver 3W, 700mA
464200



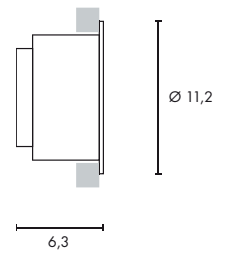

GILALED

700mA



LED
2 pce.



355°



190°



10,2



5,9



Bulb:
PowerLED (incl.)
3W
and
LED (incl.)
0,06W
Closed current, 10mA

Material:
Aluminium

Dimensions:
Supply line-L: 50 cm

Accessory/Included parts:
LED driver (excl.)

Note:
Integrated orientation light in closed position.
Flip function to change the LEDs.
Not suitable for series connection.
Therefore only operable with 3W LED driver (464200).

Versions:
silver grey
LED 3000K/blue

white
LED 3000K/warm white

Art. No.
146382

146362

Recommended connection:
LED driver 3W, 700mA
464200

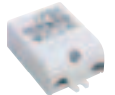





DOWNUNDER LED 15

230~ (LED) 15 pce. 7,5/21 10 max. 10 0,45 IP44



Bulb:
SMD LED (incl.)
0,9W total

Material:
Aluminium

Dimensions:
W/H/D: 9/23/7,5 cm
Flush-mounted box-W/H/D:
9,5/23,5/9 cm

Accessory/Included parts:
Flush-mounted box (incl.)

Versions:
stone grey
LED white
LED warm white
LED blue

alu brushed
LED white
LED warm white

white
LED warm white

Art. No.:
230211
230212
230217

230311
230312

230182

Note:
IP44 only with light emission
downwards!
Flush-mounted box for the
use in masonry walls.

DOWNUNDER LED 27

230~ (LED) 27 pce. 16,5/21 10 max. 10 0,75 IP44



Bulb:
SMD LED (incl.)
1,8W total

Material:
Aluminium

Dimensions:
W/H/D: 18/23/7,5 cm
Flush-mounted box-W/H/D:
18,5/23,5/9 cm

Accessory/Included parts:
Flush-mounted box (incl.)

Note:
For application in damp rooms and
outdoor areas, the lamp must be
mounted with the light emission
downwards! Flush-mounted box for
the use in masonry walls.

Versions:
stone grey
LED white
LED warm white

white
LED warm white

Art. No.:
230221
230222

230192

LED DOWNUNDER MINI

350mA (LED) 1 pce. 4,5/12,5 5 40° 0,12



Bulb:
PowerLED (incl.)
1W

Material:
Aluminium

Dimensions:
W/H/D: 6/14/4,8 cm

Accessory/Included parts:
LED driver (excl.)

Versions:
white
LED warm white, 3000K

silver grey
LED white
LED warm white, 3000K

Art. No.:
152070

152071
152072

When connecting several lamps, please take care of a series connection!

Recommended connection:
LED driver 3W, 350mA
464108

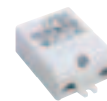

Recommended accessory:
Installation frame
steel galvanized
L/W: 20/12 cm
152079

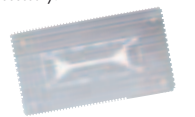

DOWNUNDER RCL 101

24~ (LED) 10 pce. 11,4/5,4 4,5 0,23



Bulb:
SMD LED (incl.)
2W total

Material:
Aluminium/stainless steel 304

Dimensions:
W/H/D: 12,5/6,5/4,7 cm

Accessory/Included parts:
Power unit (excl.)

Versions:
Stainless steel brushed
LED 5300K
LED 3200K

Art. No.:
152061
152062

Suitable for cavity walls with a material thickness of max. 15 mm.
When connecting several lamps, please pay attention to the total wattage.
Further power units can be found in the accessory range.

Recommended connection:
LED power unit 12W, 24V=
470502



Recommended accessory:
Flush-mounted frame
steel galvanized
L/W: 20/12 cm
925201





DOWNUNDER 05

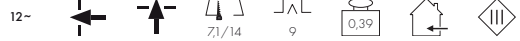

Socket/Bulb:
GY6,35/pin socket (excl.)
50W max.

Material:
Aluminium

Dimensions:
Outer-W/H: 8/15,5 cm
Rear housing-W/H/D:
19,5/7/7 cm

Accessory/Included parts:
Transformer (excl.)

Versions:
alu natural

Flush-mounted frame
for Downunder 05

Art. No.:
151973

925195

Recommended bulb:
50W, 2700K, 900lm
512250



DOWNUNDER 1

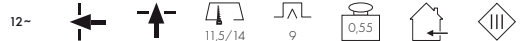

Socket/Bulb:
GY6,35/pin socket (excl.)
50W max.

Material:
Aluminium

Dimensions:
Outer-W/H: 12/15,5 cm
Rear housing-W/H/D:
10,5/19,3/7,2 cm

Accessory/Included parts:
Transformer (excl.)

Versions:
alu natural

Flush-mounted frame
for Downunder 1

Art. No.:
151970

925200

Recommended bulb:
50W, 2700K, 900lm
512250



RECOMMENDED TRANSFORMER for Downunder 05 and Downunder 1



FN Mini transformer 1
10-60 VA

Art. No.:
461060

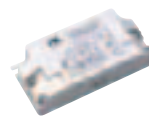

FN Mini transformer 2
10-60 VA

Art. No.:
461062

When connecting several lamps, please pay attention to the total wattage. Further transformers can be found in the accessory range.

DOWNUNDER 2

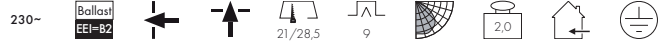

Socket/Bulb:
G24d-1/
TC-D EnergySaver 2-pin (excl.)
13W

Material:
Aluminium

Dimensions:
Outer-W/H: 22,1/30,5 cm
Rear housing-W/H/D:
20/38,5/9 cm

Accessory/Included parts:
Low-loss ballast (incl.)

Versions:
alu natural

Flush-mounted frame
for Downunder 2

Art. No.:
151971

925250

Recommended bulb:
13W, 900lm, EEK=A
508213 2700K
508313 4000K



DOWNUNDER 3



Socket/Bulb:
R7s/R7s, 118 mm (excl.)
100W max.

Material:
Aluminium

Dimensions:
Outer-W/H: 22,1/30,5 cm
Rear housing-W/H/D:
20/36/9 cm

Versions:
alu natural

Flush-mounted frame
for Downunder 3

Art. No.:
151972

925250

Recommended bulb:
100W EnergySaver ≈ 150W
2700K, 1900lm, EEK=C
519221







FOK LED Design by CDC

350mA 1 pce. 7,5/7,5 6 0,2

LED
LEDTEC

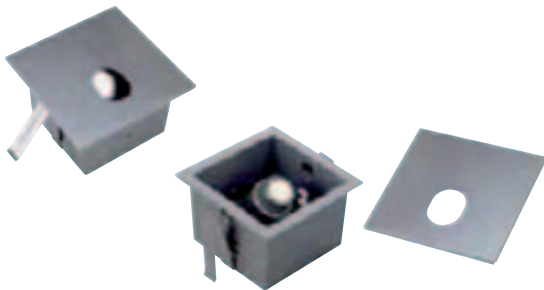

Bulb:
PowerLED (incl.)
1W

Material:
Aluminium

Dimensions:
W/H/D: 9/9/6 cm
Supply line-L: 44,5 cm

Accessory/Included parts:
Mini-plug (incl.)
LED driver (excl.)

Versions:
alu brushed
LED white
LED warm white

Art. No.:
112801
112802

When connecting several Fok LED lamps, please take care of a series connection! Please pay attention to the total wattage!
Further drivers can be found in the accessory range.

Note:
Light beam is focusable by removing the front cover!

ACCESSORY for Fok LED

	Flush-mounted box W/H/D: 8,4/12,3/6,7 cm Particularly for exposed concrete application.	Art. No.: 112781		Flush-mounted frame W/H: 13,5/13,5 cm Particularly for masonry/ flush-mounted application.	Art. No.: 112780
	Connector strip 3 outlets 2 bridges (incl.)	Art. No.: 111850		LED driver 3W, 350mA	Art. No.: 464108

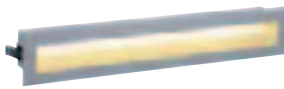
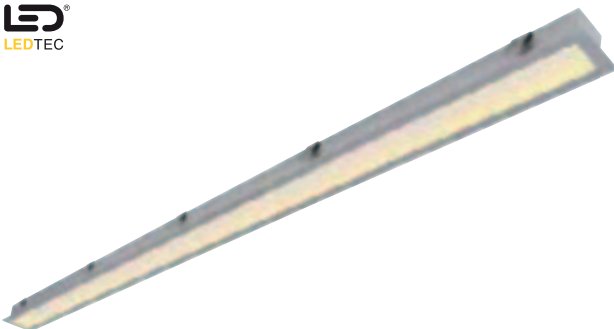
**GLENOS LED** Design by CDC**Bulb:**
LED (incl.)
3W total**Accessory/Included parts:**
Diffusor (incl.)
Power unit (excl.)**Versions:**
silver grey
LED 3200K**Art. No.:**
112812**Material:**
Aluminium/glass**Dimensions:**
W/H/D: 33,5/6/6 cm**Recommended accessory:**
Flush-mounted frame for Glenos LED
for installation in masonry walls.
112810**Recommended connection:**
LED power unit 12W, 24V=
470502**GLENOS LED XL****Bulb:**
LED (incl.)
7,5W total**Versions:**
silver grey
LED 3300K**Art. No.:**
112822**Material:**
Aluminium/acrylic**Dimensions:**
W/H/D: 99,5/8/5 cm**Accessory/Included parts:**
Diffusor (incl.)
Power unit (excl.)**Recommended connection:**
LED power unit 12W, 24V=
470502**Note:**
Suitable for cavity wall and ceilings
with a material thickness of 5-20
mm.

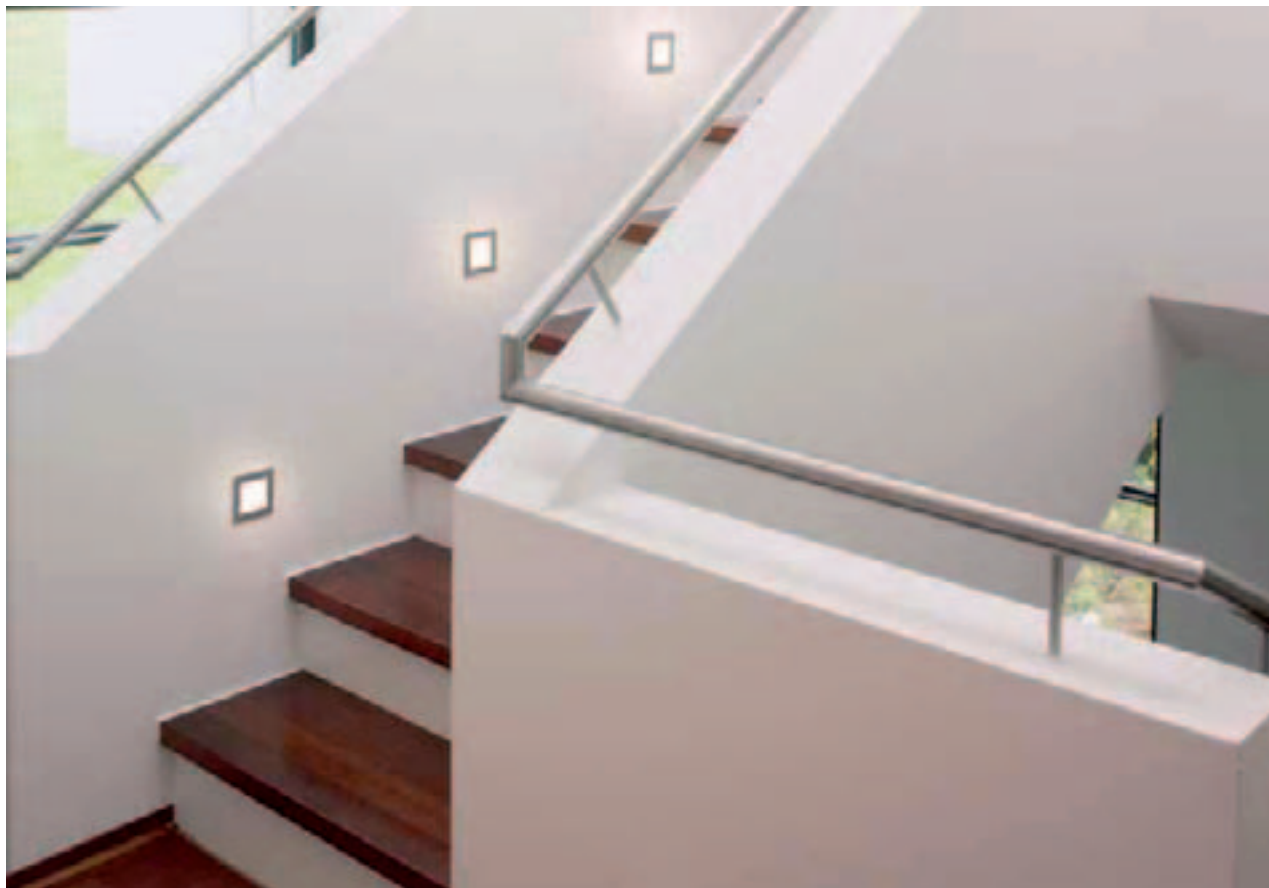

LED white | 111261 |
LED warm white | 111262 |

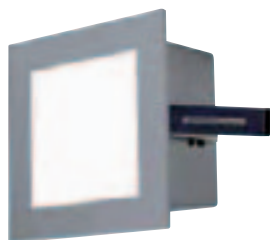

FRAME BASIC LED Design by CDC

Material:
Aluminium/glass

Dimensions:
Supply line-L: 45 cm

Accessory/Included parts:
Mini-plug (incl.)
LED driver (excl.)

Note:
Operate only with suitable LED driver/350mA.

When connecting several lamps, please pay attention to the total wattage. Further drivers can be found in the accessory range.

LED white | 111291 |
LED warm white | 111292 |
LED blue | 111297 |

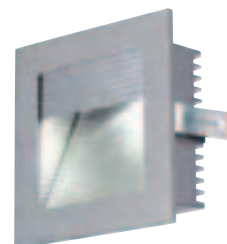

FRAME CURVE LED Design by CDC

Material:
Aluminium

Dimensions:
Supply line-L: 30 cm

Accessory/Included parts:
Mini-plug (incl.)
LED driver (excl.)

Note:
Operate only with suitable LED driver/350mA.

When connecting several lamps, please pay attention to the total wattage. Further drivers can be found in the accessory range.



FRAME LED Design by CDC

350mA



Article No.	Description	LED colour	Current	Wattage	Number/Type LEDs	Width in cm	Height in cm	Depth in cm	Installation dimensions in cm	Installation depth in cm	Weight in kg	Price
111291	Frame Curve LED	white	350 mA	1 W	1 PowerLED	9,0	9,0	3,8	7,5/7,5	4,5	0,11	
111292	Frame Curve LED	warm white	350 mA	1 W	1 PowerLED	9,0	9,0	3,8	7,5/7,5	4,5	0,11	
111297	Frame Curve LED	blue	350 mA	1 W	1 PowerLED	9,0	9,0	3,8	7,5/7,5	4,5	0,11	
111261	Frame Basic LED	white	350 mA	1 W	1 PowerLED	9,0	9,0	5,5	7,5/7,5	6,0	0,20	
111262	Frame Basic LED	warm white	350 mA	1 W	1 PowerLED	9,0	9,0	5,5	7,5/7,5	6,0	0,20	

ACCESSORY for Frame Curve LED and Frame Basic LED

Flush-mounted box
W/H/D: 8,4/12,3/6,7 cm
112781



Flush-mounted frame
W/H: 13,5/13,5 cm
112780

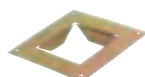

Connector strip
2 bridges (incl.)
3 outlets
111850



LED driver 3W, 350mA
464108

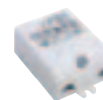





MINI FRAME LED Design by CDC

12~



Bulb:
LED (incl.)
0,3W total

Material:
Plastic/glass

Dimensions:
W/H/D: 4/4/5 cm

Accessory/Included parts:
Conventional transformer (excl.)

Versions:
silver grey
LED white
LED warm white
LED blue

Art. No.:
112711
112712
112717

Operate only with conventional transformer.
When connecting several lamps, please pay attention to the total wattage.
Further transformers can be found in the accessory range.

Recommended connection:
Conventional transformer,
10VA, 12V~
451010





LED SLIM LIGHT recessed

12~



IP67



Bulb:
SMD LED (incl.)
0,5W total

Material:
Aluminium/artificial resin

Dimensions:
Cover-Ø/H: 5,5/1 cm
Supply line-L: 2 m

Accessory/Included parts:
Conventional transformer (excl.)

Versions:
alu anodized
LED white
LED warm white

Art. No.:
550671
550672

Recommended connection:
IP44 Conv. transformer,
10VA, 12V~
451010



Can be walked on!. Mounting is only possible in solid materials like wood, parquet or laminate with clear-cut borehole. Operate only with conventional transformer!



DEKLED

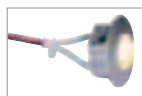

Bulb:
PowerLED (incl.)
1W

Material:
Aluminium/PC

Dimensions:
Cover-Ø/H: 3/0,5 cm
Supply line-L: 1,5 m

Accessory/Included parts:
LED driver (excl.)

Note:
When connecting several lamps,
please take care of a series
connection.

Recommended connection:
Connector strip
111850



Versions:
silver metallic
LED 5300K
LED 3200K

Art. No.:
112241
112242

Recommended connection:
LED driver 3W, 350mA
464108



LED KONKAV



Bulb:
PowerLED (incl.)
1W

Material:
Aluminium

Dimensions:
visible-Ø/H: 4/1 cm
Supply line-L: 50 cm

Accessory/Included parts:
LED driver (excl.)

Note:
When connecting several lamps,
please take care of a series
connection.

Recommended connection:
Connector strip
111850



Versions:
alu brushed
LED 5300K
LED 3200K

Art. No.:
114831
114832

Recommended connection:
LED driver 3W, 350mA
464108

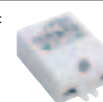

SIMIT 20° slewable



Bulb:
PowerLED (incl.)
1W

Material:
Aluminium

Dimensions:
Ø/H: 5,6/5,5 cm
Supply line-L: 15 cm

Accessory/Included parts:
Mini-plug (incl.)
LED driver (excl.)

Note:
When connecting several lamps,
please take care of a series
connection.

Recommended connection:
Connector strip
111850



Versions:
metal brushed
LED 3000K

Art. No.:
111939

Recommended connection:
LED driver 3W, 350mA
464108



TRITON MINI LED HORN

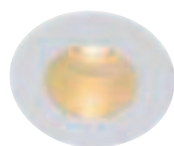

Bulb:
PowerLED (incl.)
1W

Material:
Aluminium

Dimensions:
Ø/H: 4,5/5 cm
Supply line-L: 1 m

Accessory/Included parts:
Mini-plug (incl.)
LED driver (excl.)

Note:
When connecting several lamps,
please take care of a series
connection.

Recommended connection:
Connector strip
111850



Versions:
white
LED 3000K,
60lm, Ra>80

Art. No.:
113671

Recommended connection:
LED driver 3W, 350mA
464108





LELEX 1

350mA



1 pce.



60°



5,4



3,5



25°



0,06



1 pce.



111871



Bulb:
PowerLED (incl.)
1W

Material:
Aluminium

Dimensions:
L/W/H: 6/6/2 cm
Supply line-L: 30 cm

Accessory/Included parts:
Mini-plug (incl.)
LED driver (excl.)

Note:
When connecting several lamps,
please take care of a series
connection.
Further drivers can be found in the
accessory range.

Versions:
alu brushed
LED white
LED warm white

Art. No.:
111871
111872

Recommended connection:
LED driver 3W, 350mA
464108



Recommended connection:
Connector strip
111850





LED ALUMINIUM DOWNLIGHT

700mA

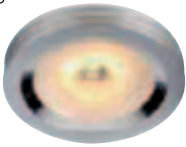
Bulb:
PowerLED (incl.)
3W

Material:
Aluminium

Dimensions:
visible-Ø/H: 7,5/1,5 cm

Accessory/Included parts:
LED driver (excl.)

Note:
When connecting several lamps,
please take care of a series
connection.

Versions:
alu brushed
LED 3200K, 114lm

Art. No.:
114802

Recommended connection:
LED driver 3W, 700mA
464200

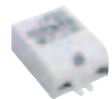

ZEBLED ROUND 3

350mA



Bulb:
PowerLED (incl.)
3x 1W

Material:
Aluminium

Dimensions:
visible-Ø/H: 7,5/2,5 cm

Accessory/Included parts:
LED driver (excl.)

Note:
When connecting several lamps,
please take care of a series
connection.
Max. ceiling thickness: 2,8 cm

Versions:
alu brushed
LED 3200K, 146lm

Art. No.:
114792

Recommended connection:
LED driver 3W, 350mA
464108

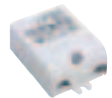



REAL N-TIC LED SERIES 108x46



Bulb:
SMD LED (incl.)
2,8W total

Versions:
chrome
LED 3200K

Art. No.:
112302

Material:
Cover: chromed stainless steel 304
Plastic

Dimensions:
Ø/H: 10,8/4,7 cm
visible-H: 1 cm
Supply line-L: 1,4 m

Recommended connection:
LED power unit 12W, 24V=
470502



Accessory/Included parts:
Power unit (excl.)

Note:
Suitable for cavity wall and ceilings
with a material thickness of 1-12 mm.

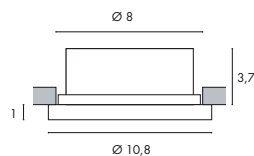

REAL N-TIC LED SERIES 152x46



Bulb:
SMD LED (incl.)
3,8W total

Versions:
chrome
LED 3200K

Art. No.:
112322

Material:
Cover: chromed stainless steel 304
Plastic

Dimensions:
Ø/H: 15,2/4,7 cm
visible-H: 1 cm
Supply line-L: 1,4 m

Recommended connection:
LED power unit 12W, 24V=
470502



Accessory/Included parts:
Power unit (excl.)

Note:
Suitable for cavity wall and ceilings
with a material thickness of 1-12 mm.

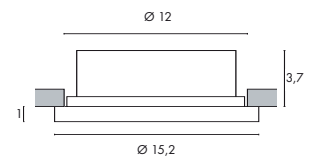

BOOST TURNO 6W

480mA (LED) 1 pce. 18° 8,2 13,3 38° 0,21



Bulb:
PowerLED (incl.)
6W

Material:
Aluminium/plastic

Dimensions:
Ø/H: 9,2/13,5 cm

Accessory/Included parts:
LED driver (excl.)

Note:
Suitable for cavity ceilings with a material thickness of max. 25 mm.

Versions:
LED 3000K, 310lm, Ra80
white
silver grey

Art. No.:
160601
160604

Recommended accessory:
LED driver 8W, 480mA
464120

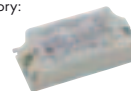

BOOST TURNO 9W

480mA (LED) 1 pce. 18° 8,2 13,5 30° 0,25



Bulb:
PlanarLED (incl.)
8W

Material:
Aluminium/plastic

Dimensions:
Ø/H: 9,2/13,7 cm

Accessory/Included parts:
LED driver (excl.)

Note:
Suitable for cavity ceilings with a material thickness of max. 25 mm.

Versions:
LED 3000K, 640lm, Ra83
white
silver grey

Art. No.:
160621
160624

Recommended accessory:
LED driver 8W, 480mA
464120



LEDPANEL ROUND

230~ (LED) 97 pce. 15 5,5 120° 0,22

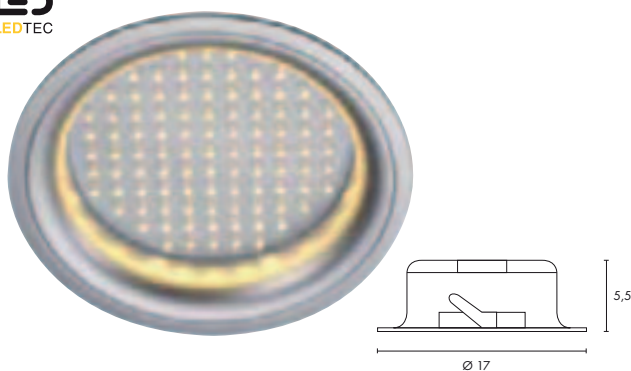

Bulb:
LED (incl.)
8W total

Material:
Plastic

Dimensions:
Ø/H: 17/5,5 cm

Accessory/Included parts:
LED converter (incl.)

Note:
Suitable for cavity ceilings with a material thickness of max. 15 mm geeignet!

Versions:
white
LED white
LED warm white
silver grey
LED white
LED warm white

Art. No.:
160371
160372
160381
160382

LEDPANEL 100

230~ (LED) 100 pce. 14/14 5 120° 0,2



Bulb:
LED (incl.)
8,5W total

Material:
Plastic

Dimensions:
L/W/D: 15/15/5 cm

Accessory/Included parts:
LED converter (incl.)

Versions:
silver grey
LED white
LED warm white

Art. No.:
160354
160352





BOOST IP44 6W

480mA 38° 0,21

LED
LEDTEC



Bulb:
PowerLED (incl.)
6W

Material:
Aluminium/plastic

Dimensions:
Ø/H: 9,2/13,8 cm

Accessory/Included parts:
LED driver (excl.)

Note:
Suitable for cavity ceilings with a material thickness of max. 25 mm.

Versions:
LED 3000K, 310lm, Ra80
white
silver grey

Art. No.:
160611
160614

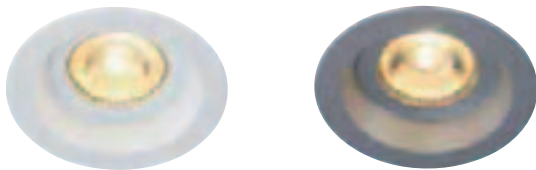

Recommended accessory:
LED driver 8W, 480mA
464120

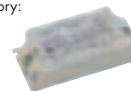

BOOST IP44 9W

480mA 30° 0,24

LED
LEDTEC



Bulb:
PlanarLED (incl.)
8W

Material:
Aluminium/plastic

Dimensions:
Ø/H: 9,2/14 cm

Accessory/Included parts:
LED driver (excl.)

Note:
For cavity ceilings with a material thickness of max. 25 mm.

Versions:
LED 3050K, 610lm, Ra82
white
silver grey

Art. No.:
160631
160634

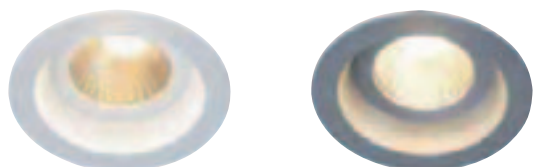

Recommended accessory:
LED driver 8W, 480mA
464120



LED HORN

700mA 60° 0,17

LED
LEDTEC

Bulb:
PowerLED (incl.)
3x 3W

Material:
Aluminium

Dimensions:
Supply line-L: 50 cm

Accessory/Included parts:
Plug (incl.)
LED driver (excl.)

Versions:
silver grey
LED 3000K, 250lm
white
LED 3000K, 250lm

Art. No.:
112882
112892

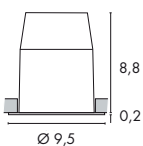
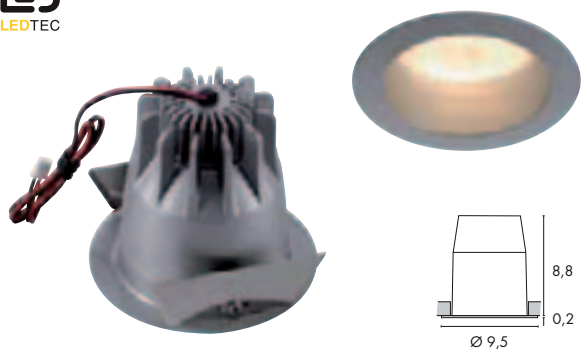

Recommended connection:
LED driver 6-12W, 700mA
464202



LED HORN COB 9W

700mA 9,2 0,2

LED
LEDTEC

Bulb:
COB LED (incl.)
9W

Material:
Plastic/aluminium

Dimensions:
Ø/H: 9,5/8,6 cm

Accessory/Included parts:
LED driver (excl.)

Note:
Suitable for cavity ceilings with a material thickness of max. 15 mm.

Versions:
white
LED 5300K, 563lm
LED 3200K, 556lm

Art. No.:
160501
160502

silver grey
LED 5300K, 563lm
LED 3200K, 556lm

Art. No.:
160511
160512

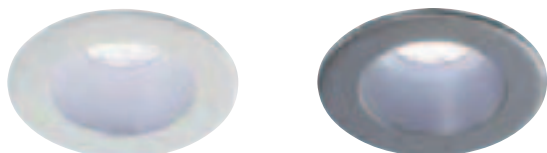



EYEDOWN LED 3x 1W

350mA LED 3 pce. ↑ 5,9 3,7 15° 0,12 IP44 III



Bulb:
PowerLED (incl.)
3x 1W

Material:
Aluminium/glass

Dimensions:
Ø/H: 6,8/4,3 cm
Supply line-L: 45 cm

Accessory/Included parts:
Mini-plug (incl.)
LED driver (excl.)

Note:
When connecting several lamps,
please take care of a series
connection.
Suitable for cavity ceilings with a
material thickness of max. 30 mm.

Versions:
alu
LED 3000K, 190lm

Art. No.:
111982

Recommended connection:
LED driver 3W, 350mA
464108



EYEDOWN LED 6x 1W

350mA LED 6 pce. ↑ 7,6 4,4 15° 0,22 IP44 III



Bulb:
PowerLED (incl.)
6x 1W

Material:
Aluminium/glass

Dimensions:
Ø/H: 8,8/5,2 cm
Supply line-L: 45 cm

Accessory/Included parts:
Mini-plug (incl.)
LED driver (excl.)

Note:
When connecting several lamps,
please take care of a series
connection.
Suitable for cavity ceilings with a
material thickness of max. 30 mm.

Versions:
alu
LED 3000K, 400lm

Art. No.:
111992

Recommended connection:
LED driver 12W, 350mA
464110

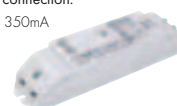

TRITON 3 LED

350mA LED 3 pce. ↑ 7 3,5 60° 25° 0,11 III



Bulb:
PowerLED (incl.)
3x 1W

Material:
Aluminium

Dimensions:
Ø/H: 8/4 cm
Supply line-L: 30 cm

Accessory/Included parts:
Mini-plug (incl.)
LED driver (excl.)

Note:
When connecting several lamps,
please take care of a series
connection.
Further drivers can be found in the
accessory range.
Suitable for cavity walls and
ceilings with a material thickness
of max. 20 mm!

Versions:
silver grey
LED 6500K, 210lm
LED 3200K, 150lm

Art. No.:
111851
111852

Versions:
matt white
LED 6500K, 210lm
LED 3200K, 150lm

Art. No.:
113661
113662

Recommended connection:
LED driver 3W, 350mA
464108



Recommended connection:
Connector strip
111850



TRITON 3 GIMBLE

350mA LED 3 pce. ↑ 350° 45° 7,8 6 25° 0,16 III

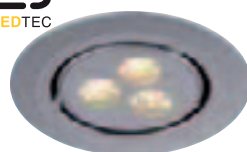

Bulb:
PowerLED (incl.)
3x 1W

Material:
Aluminium

Dimensions:
Ø/H: 9,1/4,8 cm
Supply line-L: 30 cm

Accessory/Included parts:
Mini-plug (incl.)
LED driver (excl.)

Note:
When connecting several lamps,
please take care of a series
connection.

Do not cover the rear side with
insulating material.

Suitable for cavity ceilings with a
material thickness of max. 20 mm.

Versions:
matt white
LED 6000K, 270lm
LED 3000K, 210lm

Art. No.:
113601
113602

Versions:
silver anodized
LED 6000K, 270lm
LED 3000K, 210lm

Art. No.:
113611
113612

Recommended connection:
LED driver 3W, 350mA
464108



TRITON 6

700mA



Suitable for cavity ceilings with a material thickness of max. 20 mm.

Bulb:
 PowerLED (incl.)
 6x 3W

Material:
 Aluminium

Dimensions:
 Ø/H: 12/10 cm
 visible-Ø/H: 12/0,6 cm
 Supply line-L: 30 cm

Accessory/Included parts:

 Mini-plug (incl.)
 LED driver (excl.)

Versions:
 LED 6000K, 530lm, Ra70
 matt white **113641**
 silver anodized **113651**

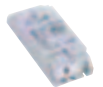
 LED 3000K, 680lm, Ra80
 matt white **113642**
 silver anodized **113652**
Recommended connection:
 LED driver 10-18W, 700mA
464201

TRITON 6 GIMBLE

350mA

 Do not cover the rear side of the lamp with insulating material.
 Suitable for cavity ceilings with a material thickness of max. 20 mm.

Bulb:
 PowerLED (incl.)
 6x 1W

Material:
 Aluminium

Dimensions:
 Ø/H: 12/6 cm
 Supply line-L: 30 cm

Accessory/Included parts:

 Mini-plug (incl.)
 LED driver (excl.)

Versions:
 LED 6000K, 530lm, Ra70
 matt white **113621**
 silver anodized **113631**

 LED 3000K, 680lm, Ra80
 matt white **113622**
 silver anodized **113632**
Recommended connection:
 3 Outlets
111850

Recommended connection:
 LED driver 18W, 350mA
464111



DomeLED DOWNLIGHT

700mA

LED
6 pce.

10,8



7,5



25°



0,28



Bulb:
PowerLED (incl.)
6x 3W

Material:
Aluminium

Dimensions:
Ø/H: 13,5/6,5 cm

Accessory/Included parts:
LED driver (excl.)

Versions:
silver grey
LED 6000K, 825lm
LED 3000K, 615lm

Art. No.:
111961
111962

Recommended connection:
LED driver 10-18W, 700mA
464201



BOOST B TURNO

350mA

LED
1 pce.

17°



12



13,3



35°



0,47

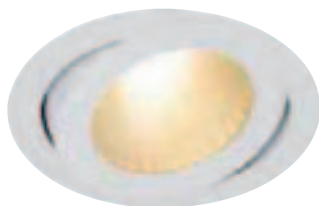

Bulb:
PlanarLED (incl.)
13W

Material:
Aluminium/plastic

Dimensions:
Ø/H: 13,3/13,5 cm

Accessory/Included parts:
LED driver (excl.)

Note:
Suitable for cavity ceilings with a
material thickness of max. 15 mm.

Versions:
LED 3050K, 1000lm, Ra>80
white
silver grey

Art. No.:
160641
160644

Recommended connection:
LED driver 18W, 350mA
464111



BOOST B IP44

350mA

LED
1 pce.

12



13,5



35°



0,43



IP44



Bulb:
PlanarLED (incl.)
13W

Material:
Aluminium/plastic

Dimensions:
Ø/H: 13,2/13,7 cm

Accessory/Included parts:
LED driver (excl.)

Note:
Suitable for cavity ceilings with a
material thickness of max. 20 mm.

Versions:
LED 3000K, 840lm, Ra>80
white
silver grey

Art. No.:
160651
160654

Recommended connection:
LED driver 18W, 350mA
464111







Recessed luminaires with Fortimo-LED-Modules from Philips.

Optics, cooling and driver for direct connection to 230 V ~ already integrated.

Particularly suitable for replacing existing halogen lighting.

High energy efficiency together with long working life (25.000 hours).

High-quality light and excellent performance.

Compact dimensions, slim design.

Colour temperature 2700K ,3000K or 4000K.

1. Fortimo LED Disk Module 800
2. Fortimo LED Disk Module 300
3. Fortimo LED Integrated spot
4. Fortimo Twistable Module



PHILIPS

LUZO LED DISK

230~

Module
1 Planar-LED

10,2



12,5



85°



0,37



LED
LEDTEC

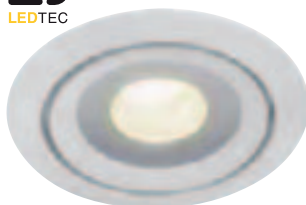

2700K, white



4000K, metal brushed



4000K, chrome matt

Bulb:
PHILIPS
Fortimo LED Disk Module (incl.)

Material:
Aluminium

Dimensions:
visible Product-Ø/H: 11,5/0,5 cm
Product-Ø/H: 11,5/13 cm

Note:
Suitable for cavity ceilings with a material thickness of max. 25 mm.

Versions:
2700K, 14,5W, 800lm, Ra90
white 115801
metal brushed 115805
chrome matt 115808

Art. No.:
115801
115805
115808

4000K, 15,2W, 850lm, Ra80
white 115811
metal brushed 115815
chrome matt 115818

LUZO INTEGRATED LED

230~

Module
6 LEDs

10,2



12,5



36°



0,51



LED
LEDTEC

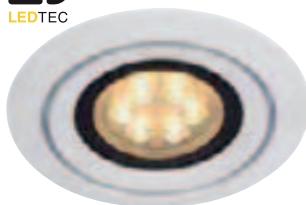

2700K, white



3000K, metal brushed



4000K, chrome matt

Bulb:
PHILIPS
Fortimo Integrated Spot (incl.)
13W

Material:
Aluminium

Dimensions:
visible Product-Ø/H: 11,5/0,5 cm
Product-Ø/H: 11,5/13 cm

Note:
Suitable for cavity ceilings with a material thickness of max. 25 mm.

Versions:
2700K, 610lm, Ra80,
white 115821
metal brushed 115825
chrome matt 115828

Art. No.:
115821
115825
115828

3000K, 640lm, Ra80
white 115831
metal brushed 115835
chrome matt 115838

4000K, 640lm, Ra80
white 115841
metal brushed 115845
chrome matt 115848





LEDDISK HORN DL

230~

Module
1 Planar-LED

10,2



10



60°



0,34

**Bulb:****PHILIPS**

Fortimo LED Disk Module (incl.)

Material:

Aluminium/plastic

Dimensions:

Ø/H: 12/10 cm

Versions:

2700K, 14,5W, 800lm, Ra90

white

silver grey

Art. No.:

160540

160541

160544

4000K, 15,2W, 850lm, Ra80

white

silver grey

160551

160554

Note:

Suitable for cavity ceilings with a material thickness of max. 20 mm.

NEW TRIA LED Disk

230~

Module
1 Planar-LED

12,7



16,7



45°



35°



60°



0,75

**Bulb:****PHILIPS**

Fortimo LED Disk Module (incl.)

Material:

Aluminium

Dimensions:visible Product-Ø/H: 14,1/0,25 cm
Product-Ø/H: 14,1/16,9 cm**Versions:**

2700K, 14,5W, 630lm, Ra90

matt white

35°

60°

Art. No.:

113581

113581

113581

113591

silver grey

35°

60°

113584

113594

Note:

Suitable for cavity ceilings with a material thickness of max. 20 mm.

4000K, 15,2W, 630lm, Ra80

matt white

35°

60°

113561

113571

silver grey

35°

60°

113564

113574

LED DOWNLIGHT PRO R

230~

Module
1 Planar-LED

14,5



14



60°



0,65

**Bulb:****PHILIPS**

Fortimo LED Disk Module (incl.)

Material:

Aluminium/glass

Dimensions:Ø/H: 15,5/14,3 cm
visible-Ø/H: 15,5/0,3 cm**Versions:**

2700K, 14,5W, 800lm, Ra90

white

silver grey

Art. No.:

162401

162401

162404

4000K, 15,2W, 850lm, Ra80

white

silver grey

162411

162414

Note:

Suitable for cavity ceilings with a material thickness of max. 35 mm.



LED DOWNLIGHT PRO RT



Bulb:
PHILIPS
Fortimo LED Twistable Module
(excl.)
20W max.

Material:
Aluminium/glass

Dimensions:
Ø/H: 20/13,5 cm
visible-Ø/H: 20/0,5 cm

Recommended bulb:
PHILIPS Fortimo LED Twistable Module
18W, 4000K, 1100lm
560201



Note:
Suitable for cavity ceilings with a
material thickness of 35 mm.

Versions:
white
silver grey

Art. No.:
162441
162444

Recommended bulb:
PHILIPS Fortimo LED Twistable Module
20W, 3000K, 1100lm
560202

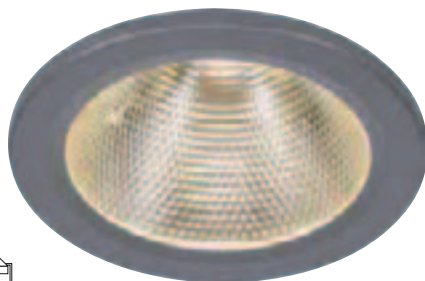

15W LED DOWNLIGHT

Bulb:
Planar LED (incl.)
15W

Material:
Aluminium/steel/glass

Accessory/Included parts:
LED driver (excl.)

Note:
Suitable for cavity ceilings with a
material thickness of max. 35 mm.

Versions:
5500K 1100lm
white
silver grey

Art. No.:
160401
160411

3100K, 750lm
white
silver grey

Art. No.:
160402
160412

Recommended connection:
LED driver 5-15W, 1200mA
464210

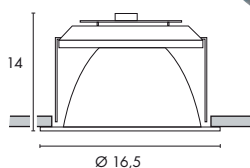

LED DOWNLIGHT 14/3



Bulb:
SMD LED (incl.)
8W

Material:
Aluminium/plastic

Dimensions:
Ø/H: 14,8/12,3 cm

Accessory/Included parts:
LED driver (incl.)

Note:
Suitable for cavity ceilings with a
material thickness of max. 30 mm.

Versions:
3000K, 520lm, Ra>80
white

Art. No.:
160421

LED DOWNLIGHT 30/3



Bulb:
SMD LED (incl.)
15W

Material:
Aluminium/plastic

Dimensions:
Ø/H: 19,7/12,3 cm

Accessory/Included parts:
LED driver (incl.)

Note:
Suitable for cavity ceilings with a
material thickness of max. 30 mm.

Versions:
3000K, 1200lm, Ra>80
white

Art. No.:
160441



LED DOWNLIGHT 36/3

230~

LED
36 pce.

22



12



120°



0,62

**Bulb:**
SMD LED (incl.)
20W**Material:**
Aluminium/plastic**Dimensions:**
Ø/H: 23,3/12 cm**Accessory/Included parts:**
LED driver (incl.)**Note:**
Suitable for cavity ceilings with a
material thickness of max. 30 mm.**Versions:**
3000K, 1600lm, Ra>80
white**Art. No.:**
160461

LED DOWNLIGHT PRO R frameless

230~

Module
1 Planar-LED

15



16,5



120°



0,6

**Bulb:**
PHILIPS
Fortimo LED Disk Module (incl.)**Material:**
Aluminium/acrylic**Dimensions:**
Ø/H: 15/16,5 cm**Note:**
Suitable for cavity ceilings with a
material thickness of 10-50 mm.**Versions:**
2700K, 14,5W, 800lm, Ra90
white**Art. No.:**
1624604000K, 15,2W, 850lm, Ra80
white

162470

LED DOWNLIGHT PRO S frameless

230~

Module
1 Planar-LED

14,2/14,2



16,5



120°

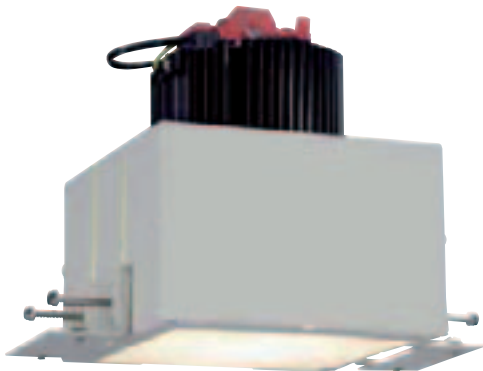

0,87

**Bulb:**
PHILIPS
Fortimo LED Disk Module (incl.)**Material:**
Aluminium/acrylic**Dimensions:**
L/W/H: 14,2/14,2/16,5 cm**Note:**
Suitable for cavity ceilings with a
material thickness of 10-50 mm.**Versions:**
2700K, 14,5W, 800lm, Ra90
white**Art. No.:**
1624644000K, 15,2W, 850lm, Ra80
white

162474

LED DOWNLIGHT PRO S

230~

Module
1 Planar-LED

12,5/12,5

13,1

60°

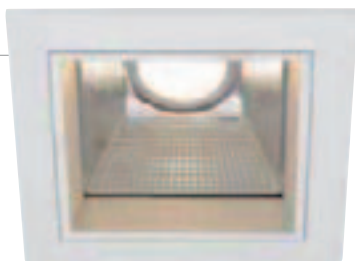

0,61

LED
LEDTEC

Bulb:
PHILIPS
Fortimo LED Disk Module (incl.)

Material:
Aluminium/glass

Dimensions:
L/W/H: 14/14/13,8 cm
visible-L/W/H: 14/14/0,7 cm

Note:
Suitable for cavity ceilings with a material thickness of 35 mm.

Versions:
2700K, 14,5W, 800lm, Ra90
white 162421
silver grey 162424

4000K, 15,2W, 850lm, Ra80
white 162431
silver grey 162434

LED DOWNLIGHT PRO ST

230~



18/18

16

60°

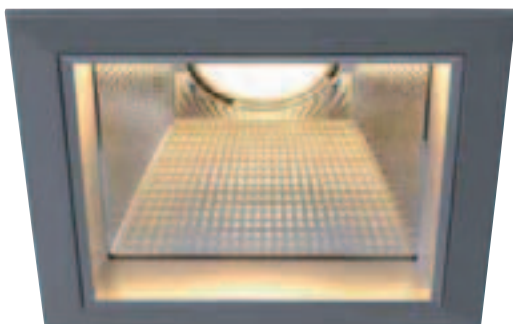

0,9

LED
LEDTEC

Bulb:
PHILIPS
Fortimo LED Twistable Module (excl.)
20Wmax.

Material:
Aluminium/glass

Dimensions:
L/W/H: 20/20/16,7 cm
visible-L/W/H: 20/20/0,7 cm

Recommended bulb:
PHILIPS Fortimo LED Twistable Module
18W, 4000K, 1100lm
560201



Note:
Suitable for cavity ceilings with a material thickness of 35 mm.

Versions:
white 162451
silver grey 162454

Recommended bulb:
PHILIPS Fortimo LED Twistable Module
20W, 3000K, 1100lm
560202



FORTY-TWO LED Downlight

230~

Module
1 Planar-LED

17,2

22

90°

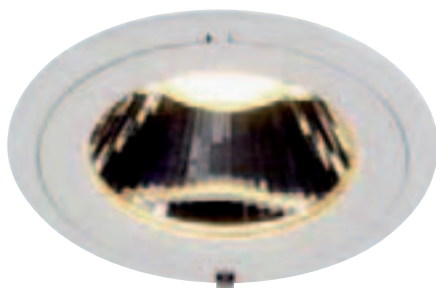

1,7

IP20/
IP43LED
LEDTEC

Bulb:
PHILIPS
Fortimo LED DLM Module (incl.)
42W

Material:
Aluminium/plastic

Dimensions:
Ø/H: 18/22 cm
Vorschaltgerät L/W/H:
22/8,3/3,5 cm

Accessory/Included parts:
LED driver (incl.)

Note:
Protection class IP20 is valid for the back-construction of the lamp.
Protection class IP43 is valid for the visible front area after mounting the lamp.
For effective heat dissipation in the cavity ceiling, a space of min. (L/W/H) 110/28/22 cm per lamp should be available to ensure a proper operation of the LED.

Versions:
4000K, 3000lm, Ra>80
white 114001
silver grey 114011

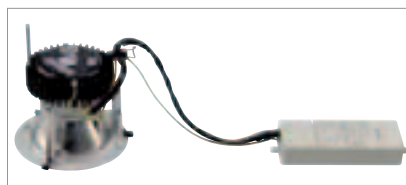



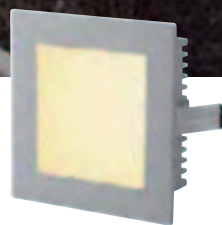

Basic | 112732 |

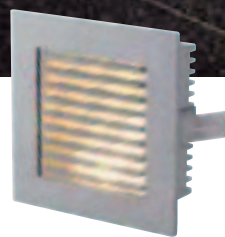

Slot | 112762 |

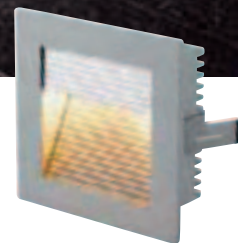

Curve | 112772 |

FLAT FRAMES

12~



Material:
Aluminium/glass

Accessory/Included parts:
Transformer (excl.)

Recommended bulb:
20W, 2700K, 330lm
512220



Article No.	Description	Colour	Voltage in AC	Socket/ Bulb (excl.)	Wattage Bulb	Width in cm	Height in cm	Depth in cm	Installation dimensions in cm	Installation depth in cm	Weight in kg	Price
112732	Flat Frame Basic	silver grey	12V	G4/pin socket	20W max.	9,0	9,0	3,1	7,5/7,5	4,5	0,15	
112762	Flat Frame Slot	silver grey	12V	G4/pin socket	20W max.	9,0	9,0	3,1	7,5/7,5	4,5	0,15	
112772	Flat Frame Curve	silver grey	12V	G4/pin socket	20W max.	9,0	9,0	3,1	7,5/7,5	4,5	0,15	

ACCESSORY for Flat Frames

Flush-mounted box:
W/H/D: 8,4/12,3/6,7 cm
112781

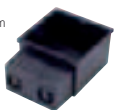

Flush-mounted frame:
W/H: 13,5/13,5 cm
112780

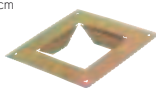

Recommended connection:
Osram Mouse 70, 20-70VA
461075



When connecting several lamps, please pay attention to the total wattage!
Further transformer options can be found in the accessory range.

Recommended connection:
FN Mini transformer 1, 10-60VA
461060



When connecting several lamps, please pay attention to the total wattage!
Further transformer options can be found in the accessory range.

**FRAME BASIC JC**

silver grey 111202

Material: Aluminium

Accessory/Included parts: Transformer (excl.)

Note: Only for cavity walls and ceilings.

Recommended bulb:
20W, 2700K, 330lm
512220**FRAME**silver grey 151871
metal brushed 151878

Material: Steel

Accessory/Included parts: Transformer (excl.)

Recommended bulb:
10W, 2700K, 120lm
512210**FRAME CURVE**

silver grey 151862

Material: Steel

Accessory/Included parts: Transformer (excl.)

Recommended bulb:
10W, 2700K, 120lm
512210**ACCESSORY**Flush-mounted frame
for Art. No.: 151862/-71/-78
Installation-W/H: 7/6,5 cm
Outer-W/L: 12/12 cm
925100Recommended connection:
FN Mini transformer 1, 10-60VA
461060When connecting several lamps, please pay attention to the total wattage!
Further transformer options can be found in the accessory range.**FRAMES**

12~



Article No.	Description	Colour	Voltage in AC	Socket/Bulb (excl.)	Wattage Bulb	Width in cm	Height in cm	Depth in cm	Installation dimensions in cm	Installation depth in cm	Material thickness installation surface	Weight in kg	Price
111202	Frame Basic JC	silver grey	12V	G4/pin socket	20W max.	9,0	9,0	12,0	7,5/7,5	13,0	-	0,25	
151871	Frame	silver grey	12V	G4/pin socket	10W max.	7,5	7,5	5,0	6,5/7,1	6,0	> 8 mm	0,23	
151878	Frame	metal brushed	12V	G4/pin socket	10W max.	7,5	7,5	5,0	6,5/7,1	6,0	> 8 mm	0,23	
151862	Frame Curve	silver grey	12V	G4/pin socket	10W max.	7,5	7,5	5,0	6,5/7,1	6,0	> 8 mm	0,23	

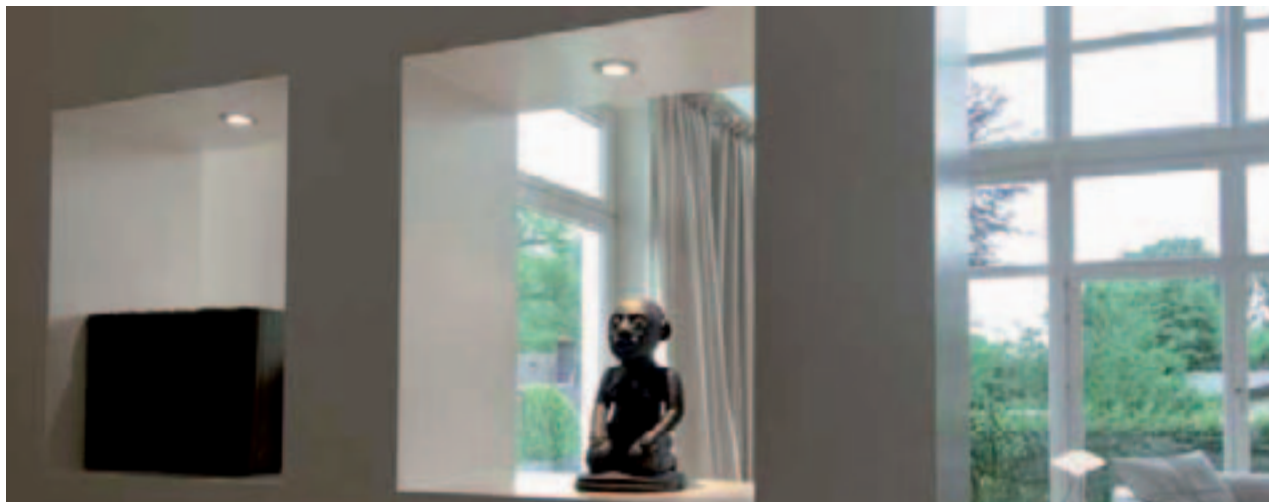

SLIM MR16 Design by CDC

12~



Socket/Bulb:
G5,3/MR16 (excl.)
50W max.

Material:
Aluminium

Dimensions:
Cover-Ø: 7 cm

Accessory/Included parts:
Transformer (excl.)

Recommended connection:
FN E-Transformer 01, 20-60VA
461067



Versions:
alu anodized

Recommended bulb:
50W, 40°, 2700K, 1500cd
536540



Art. No.:
111308

HORN MR16

12~

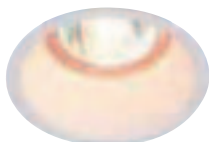

Socket/Bulb:
G5,3/MR16 (excl.)
50W max.

Material:
Steel

Dimensions:
Ø/H: 8,3/11,5 cm

Accessory/Included parts:
Transformer (excl.)

Recommended connection:
FN E-Transformer 02, 20-105VA
461107



Versions:
white

Recommended bulb:
50W, 40°, 2700K, 1500cd
536540



Art. No.:
112901

HORN 2 TURNO MR16

12~



Socket/Bulb:
G5,3/2x MR16 (excl.)
2x 50W max.

Material:
Aluminium/steel

Dimensions:
L/W/H: 18,3/11,3/10 cm
visible-L/W/H: 18,3/11,3/0,09 cm

Accessory/Included parts:
Transformer (excl.)

Note:
Suitable for cavity ceilings with a
material thickness of max. 25 mm.

Recommended connection:
FN E-Transformer 02, 20-105VA
461107



Versions:
matt white

Recommended bulb:
PHILIPS PowerLED 4W
36°, 3000K, 500cd
560044



Art. No.:
113101



DORU

12~



Socket/Bulb:
G5,3/MR16 (excl.)
20W max.

Material:
Aluminium/glass

Dimensions:
Ø: 8,5 cm

Accessory/Included parts:
Transformer (excl.)

Recommended connection:
FN E-Transformer 01, 20-60VA
461067



Versions:
Glass satined
alu natural

Recommended bulb:
20W, 40°, 2700K, 450cd
536240



Art. No.:
111432



CHROME DOWNLIGHT, ROUND

12~



Socket/Bulb:
G5,3/MR16 (excl.)
50W max.

Material:
Aluminium

Dimensions:
Product-Ø/H: 10/11 cm
Cover-Ø/H: 10/1,5 cm

Accessory/Included parts:
Transformer (excl.)

Versions:
chrome

Art. No.:
114982

Note:
Suitable for cavity ceilings with a material thickness of max. 14 mm.

Recommended connection:
FN E-Transformer 01, 20-60VA
461067



Recommended bulb:
35W, 38°, 2700K, 810cd
536338



PIKA

12~



white



chrome



brass



silver grey

Socket/Bulb:
G5,3/MR16 (excl.)
50W max.

Material:
Aluminium

Dimensions:
Cover-Ø: 8 cm

Accessory/Included parts:
Transformer (excl.)

Versions:
white
chrome
brass
silver grey

Art. No.:
111181
111182
111183
111189

Recommended connection:
FN E-Transformer 01, 20-60VA
461067



Recommended bulb:
50W, 40°, 2700K, 1500cd
536540



FGL OUT MR16, ROUND

12~

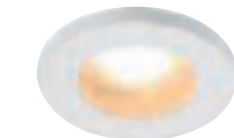

white

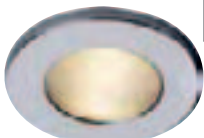

chrome

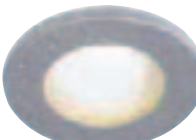

titanium

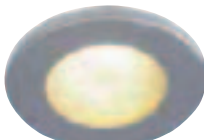

silver grey



Socket/Bulb:
G5,3/MR16 (excl.)
35W max.

Material:
Aluminium/glass

Dimensions:
Cover-Ø: 8 cm

Accessory/Included parts:
Transformer (excl.)

Versions:
Glass satined
white
chrome
titanium
silver grey

Art. No.:
111001
111002
111007
111008

Recommended connection:
FN E-Transformer 01, 20-60VA
461067



Recommended bulb:
35W, 38°, 2700K, 810cd
536338



LUZO 2

12~



white



silver grey



chrome matt



metal brushed

Socket/Bulb:
G5,3/MR16 (excl.)
50W max.

Material:
Aluminium/glass

Dimensions:
Cover-Ø: 11,5 cm

Accessory/Included parts:
Transformer (excl.)

Versions:
white
silver grey

chrome matt
metal brushed

Art. No.:
113311
113319

113317
113318

Recommended connection:
FN E-Transformer 01, 20-60VA
461067



Recommended bulb:
50W, 40°, 2700K, 1500cd
536540







MR11 SP



Socket/Bulb:
G4/MR11 (excl.)
20W max.

Versions:
white
silver grey

Art. No.:
111051
111059

Material:
Aluminium

chrome

111052

Dimensions:
Cover-Ø: 6,4 cm

Accessory/Included parts:
Transformer (excl.)

Recommended connection:
FN E-Transformer 01, 20-60VA
461067

Recommended bulb:
20W, 30°, 2700K, 450cd
533228



MR16 SP



Socket/Bulb:
G5,3/MR16 (excl.)
50W max.

Versions:
black
white
silver grey

Art. No.:
112090
112091
112099

Material:
Aluminium

chrome
titanium
chrome matt

112092
112097
112098

Dimensions:
Cover-Ø: 8,8 cm

Accessory/Included parts:
Transformer (excl.)

Recommended connection:
FN E-Transformer 01, 20-60VA
461067

Recommended bulb:
50W, 40°, 2700K, 1500cd
536540



PIKA, SLEWABLE

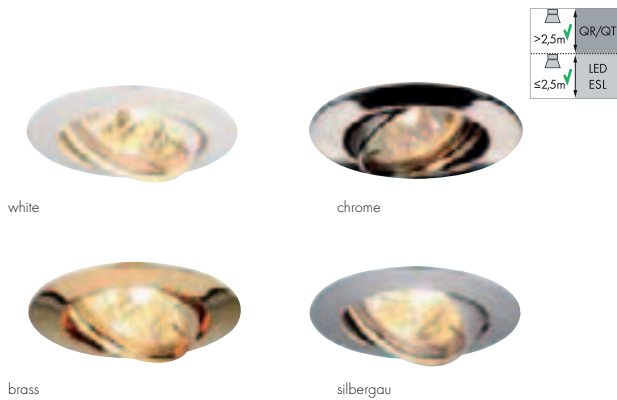

Socket/Bulb:
G5,3/MR16 (excl.)
50W max.

Versions:
white
chrome
brass
silver grey

Art. No.:
111171
111172
111173
111179

Material:
Aluminium

Dimensions:
Cover-Ø: 8,5 cm

Accessory/Included parts:
Transformer (excl.)

Recommended connection:
FN E-Transformer 01, 20-60VA
461067

Recommended bulb:
50W, 40°, 2700K, 1500cd
536540



NEW TRIA ROUND, MR16

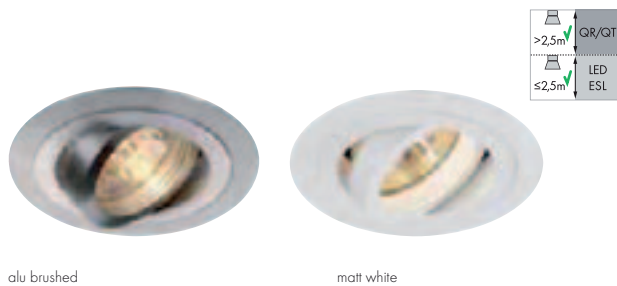
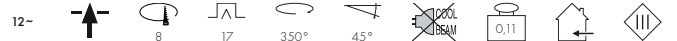

Socket/Bulb:
G5,3/MR16 (excl.)
50W max.

Versions:
alu brushed
matt white

Art. No.:
111274
113500

Material:
Aluminium

Dimensions:
Cover-Ø: 9 cm

Accessory/Included parts:
Transformer (excl.)

Recommended bulb:
50W, 40°, 2700K, 1500cd
536540





NEW TURNO MR16

12~



7,5



7



30°



Socket/Bulb:
G5,3/MR16 (excl.)
35W max.

Versions:
white

Art. No.:
112831



white

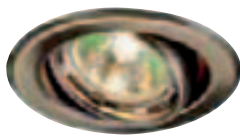

old brass

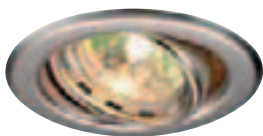

titanium



metal brushed

Material:
Steel

Dimensions:
Cover-Ø: 9,4 cm

Accessory/Included parts:
Transformer (excl.)

chrome
old brass
titanium
metal brushed
silver grey

112832
112834
112837
112838
112839

Recommended bulb:
35W, 38°, 2700K, 810cd
536338





TRIA 2 DOWNLIGHT

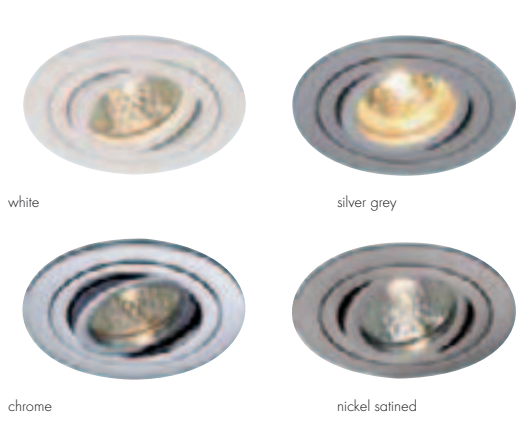
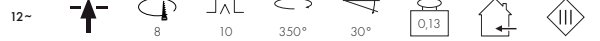

Socket/Bulb:
G5,3/MR16 (excl.)
35W max.

Versions:
white
silver grey

Art. No.:
111441
111449

Material:
Aluminium

chrome
nickel satined

111442
111447

Dimensions:
Cover-Ø: 9 cm

Accessory/Included parts:
Transformer (excl.)

Recommended bulb:
35W, 38°, 2700K, 810cd
536338



AUSTRATURN

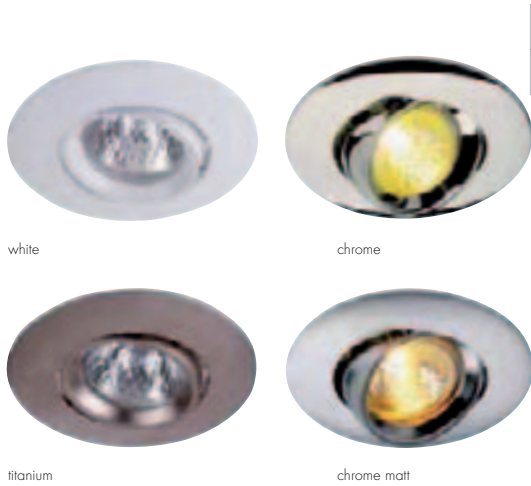
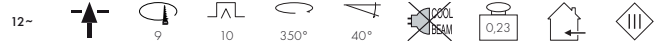

Socket/Bulb:
G5,3/MR16 (excl.)
50W max.

Versions:
white
chrome
titanium
chrome matt
silver grey

Art. No.:
112061
112062
112067
112068
112069

Material:
Aluminium

Dimensions:
Cover-Ø: 10,2 cm

Accessory/Included parts:
Transformer (excl.)

Recommended bulb:
50W, 40°, 2700K, 1500cd
536540



GIMBLE ROUND MR16

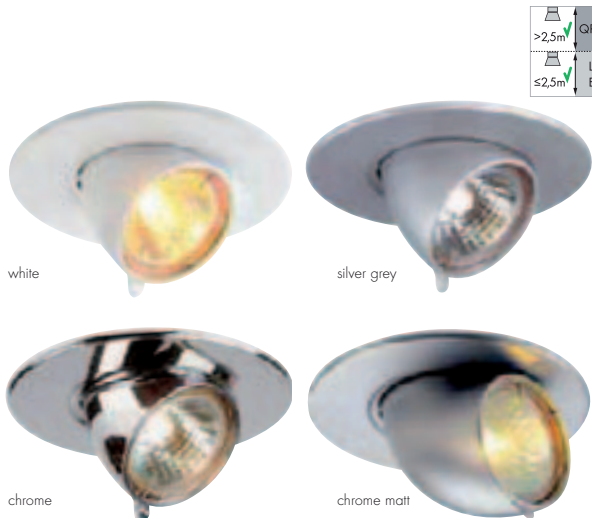

Socket/Bulb:
G5,3/MR16 (excl.)
50W max.

Versions:
white
silver grey

Art. No.:
112151
112158

Material:
Aluminium

chrome
chrome matt

112152
112157

Dimensions:
Cover-Ø: 11,5 cm

Accessory/Included parts:
Transformer (excl.)

Recommended bulb:
50W, 40°, 2700K, 1500cd
536540



Recommended connection:
FN Mini transformer 1, 10-60VA
461060



Recommended connection:
FN E-Transformer 04, 50-210VA
461217



Recommended connection:
IV distribution block 6-fold
410140





SQUARE



white



chrome



titanium



chrome matt



Socket/Bulb:
G5,3/MR16 (excl.)
50W max.

Material:
Aluminium

Dimensions:
Cover-L/W: 8,7/8,7 cm

Accessory/Included parts:
Transformer (excl.)

Versions:
white
silver grey

chrome
titanium
chrome matt

Art. No.:
113201
113209

113202
113207
113208

Recommended bulb:
50W, 40°, 2700K, 1500cd
536540



FGL OUT MR16, SQUARE

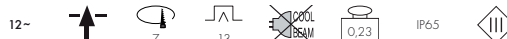

white



titanium



chrome



silver grey



Socket/Bulb:
G5,3/MR16 (excl.)
35W max.

Material:
Aluminium/glass

Dimensions:
Cover-W/L: 8,9/8,9 cm

Accessory/Included parts:
Transformer (excl.)

Versions:
Glass satined
white
chrome
titanium
silver grey

Art. No.:
111121
111122
111127
111128

Recommended bulb:
35W, 38°, 2700K, 810cd
536338



CHROM DOWNLIGHT, SQUARE



Socket/Bulb:
G5,3/MR16 (excl.)
50W max.

Material:
Aluminium

Dimensions:
L/W/H: 10/10/11 cm
Cover-L/W/H: 10/10/1,5 cm

Accessory/Included parts:
Transformer (excl.)

Note:
Suitable for cavity ceilings with a
material thickness of max. 14 mm.

Versions:
chrome

Art. No.:
114992

Recommended bulb:
35W, 38°, 2700K, 810cd
536338



NICELIGHT 1



Socket/Bulb:
GX5,3/MR16 (excl.)
50W max.

Material:
Aluminium/glass

Dimensions:
visible-L/W/H: 13/13/0,5 cm

Accessory/Included parts:
Transformer (excl.)

Versions:
alu brushed

Art. No.:
114941

Recommended bulb:
50W, 40°, 2700K, 1500cd
536540



Recommended connection:
FN Mini transformer 1, 10-0VA
461060



Recommended connection:
FN E-Transformer 04, 50-210VA
461217



Recommended connection:
LV distribution block 6-fold
410140







FRAME BASIC MR16

12~



Socket/Bulb:
G5,3/MR16 (excl.)
50W max.

Material:
Aluminium/glass

Dimensions:
W/H/D: 9/9/12 cm

Accessory/Included parts:
Transformer (excl.)

Note:
Suitable for cavity wall and
ceilings!

Versions:
silver grey

Art. No.:
111222

Recommended bulb:
50W, 40°, 2700K, 1500cd
536540



FRAME DISTA MR16

12~

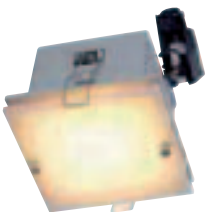

Socket/Bulb:
G5,3/MR16 (excl.)
35W max.

Material:
Aluminium/glass

Dimensions:
W/H/D: 9/9/12,5 cm

Accessory/Included parts:
Transformer (excl.)

Note:
Suitable for cavity wall and
ceilings!

Versions:
silver grey ▼

Art. No.:
111232

Recommended bulb:
35W, 38°, 2700K, 810cd
536338





TWISTER

12~

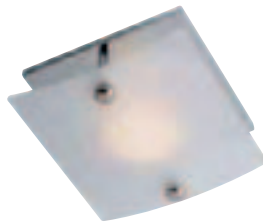
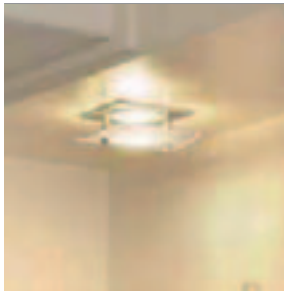

Socket/Bulb:
G5,3/MR16 (excl.)
50W max.

Material:
Aluminium/glass

Dimensions:
L/W/H: 7/7/3 cm

Accessory/Included parts:
Transformer (excl.)

Versions:
Glass satined
chrome

Art. No.:
111112

Recommended bulb:
50W, 40°, 2700K, 1500cd
536540



INDI REC 1S cardanic

12~



Socket/Bulb:
G5,3/MR16 (excl.)
50W max.

Material:
Steel

Dimensions:
L/W/H: 10/10/11 cm

Accessory/Included parts:
Transformer (excl.)

Note:
Suitable for cavity ceilings with a
material thickness of max.
0,5-20 mm.

Versions:
silver grey/black

Art. No.:
112444

Recommended bulb:
50W, 40°, 2700K, 1500cd
536540



INDI REC 2S

12~



Socket/Bulb:
G5,3/MR16 (excl.)
2x 35 max.

Material:
Steel

Dimensions:
L/W/H: 18/9/13,5 cm

Accessory/Included parts:
Transformer (excl.)

Note:
Suitable for cavity ceilings with a
material thickness of max.
0,5-20 mm.

Versions:
silver grey/black

Art. No.:
112464

Recommended bulb:
35W, 38°, 2700K, 810cd
536338



Recommended connection:
FN Mini transformer 1, 10-60VA
461060



Recommended connection:
FN E-Transformer 04, 50-210VA
461217



Recommended connection:
LV distribution block 6-fold
410140





ROW MR16



Material:
Aluminium



Accessory/Included parts:
Transformer (excl.)

Note:
The specified dimensions refer to
the visible part of the product.

Recommended transformer:
FN Mini transformer 1, 10-60VA
461060



Recommended bulb:
50W, 40°, 2700K, 1500cd
536540



Article No.	Description	Colour	Voltage in AC	Socket/Bulb (excl.)	Wattage Bulb	Width in cm	Height in cm	Installation dimensions in cm	Installation depth in cm	Rotation/Swivel range	Weight in kg	Price
112531	Row 1 MR16	silver grey	12V	GU5,3/MR16	50W max.	11,0	11,0	∅ 9,7	9,5	350°/45°	0,2	
112631	Row 1 MR16	white	12V	GU5,3/MR16	50W max.	11,0	11,0	∅ 9,7	9,5	350°/45°	0,2	



NEW TRIA MR16



Material:
Aluminium



Accessory/Included parts:
Transformer (excl.)

Note:
When connecting several lamps,
please pay attention to the total
wattage! Further transformer
options can be found in the
accessory range.

Recommended bulb:
50W, 40°, 2700K, 1500cd
536540



Recommended connection:
Osram Mouse 150, 50-150VA
461155



Article No.	Description	Colour	Voltage in AC	Socket/Bulb (excl.)	Wattage Bulb	Length in cm	Width in cm	Height in cm	Installation dimensions in cm	Installation depth in cm	Rotation/Swivel range	Weight in kg	Price
111351	New Tria 1 MR16	alu brushed	12V	G5,3/MR16	50W max.	9,0	9,0	13,0	∅ 8,0	13,0	360°/30°	0,15	
113501	New Tria 1 MR16	matt white	12V	G5,3/MR16	50W max.	9,0	9,0	13,0	∅ 8,0	13,0	360°/30°	0,15	
111352	New Tria 2 MR16	alu brushed	12V	G5,3/MR16	2x 50W max.	17,0	9,0	13,0	16,0/8,2	13,0	360°/30°	0,30	
111353	New Tria 3 MR16	alu brushed	12V	G5,3/MR16	3x 50W max.	25,5	9,0	13,0	24,5/8,2	13,0	360°/30°	0,43	



AIXLIGHT® MOD MR16



Material:
Aluminium/steel



Accessory/Included parts:
Transformer (excl.)

Note:
Further transformer options can be
found in the accessory range.

Recommended bulb:
50W, 40°, 2700K, 1500cd
536540



Recommended connection:
Osram Mouse 150, 50-150VA
461155



Article No.	Description	Colour	Voltage in AC	Socket/Bulb (excl.)	Wattage Bulb	Length in cm	Width in cm	Height in cm	Installation dimensions in cm	Installation depth in cm	Rotation/Swivel range	Weight in kg	Price
154112	Aixlight® Mod 1 MR16	silver grey	12V	GU5,3/MR16	50W max.	13,5	13,5	10,0	11,0/11,0	9,5	cardanic	0,40	
154122	Aixlight® Mod 2 MR16	silver grey	12V	GU5,3/MR16	2x 50W max.	24,0	13,5	10,0	22,0/11,0	9,5	cardanic	0,75	
154132	Aixlight® Mod 3 MR16	silver grey	12V	GU5,3/MR16	3x 50W max.	35,0	13,5	10,0	32,5/11,0	9,5	cardanic	1,10	
154142	Aixlight® Mod 4 MR16	silver grey	12V	GU5,3/MR16	4x 50W max.	23,0	23,0	10,0	20,0/20,0	9,5	cardanic	1,75	





LIGHT POINT

12~



2,6



3



0,05



Socket/Bulb:
G4/pin socket (excl.)
10W max.

Material:
Aluminium

Dimensions:
Cover-Ø: 3 cm
Supply line: 14 cm

Accessory/Included parts:
Transformer (excl.)

Versions:
With open cable end
white
chrome

Art. No.:
118011
118012

Recommended bulb:
10W, 2700K, 120lm
512210



Modification to LED technology by using the bulb G4 LED Super Flux and G4 High Power LED. Operate only with conventional transformer!



CRYSTAL 7

12~



5,6



11



0,71

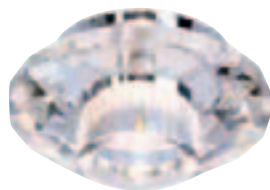

Socket/Bulb:
G4/pin socket (excl.)
20W max.

Material:
Steel/crystal glass

Dimensions:
visible-Ø/H: 11/5 cm

Accessory/Included parts:
Transformer (excl.)

Versions:
chrome/crystal clear

Art. No.:
114927

Recommended bulb:
20W, 2700K, 330lm
512220



CRYSTAL 8

12~



5,0



11



0,69

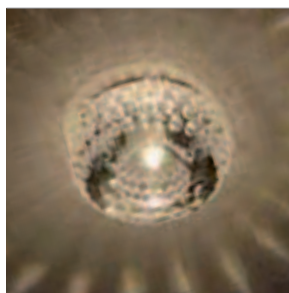

Socket/Bulb:
G4/pin socket (excl.)
20W max.

Material:
Steel/crystal glass

Dimensions:
visible-Ø/H: 9,7/5 cm

Accessory/Included parts:
Transformer (excl.)

Note:
Suitable for cavity ceilings with a material thickness up to max. 15 mm.

Versions:
crystal clear

Art. No.:
114931

Recommended bulb:
20W, 2700K, 330lm
512220



YUDI

12~



5,6



11



0,63

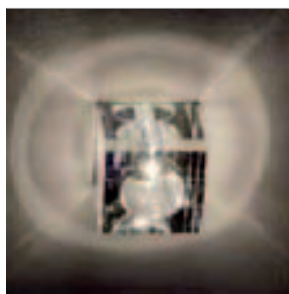

Socket/Bulb:
G6,35/pin socket (excl.)
35W max.

Material:
crystal glass

Dimensions:
visible L/W/H: 7/7/6,1 cm

Accessory/Included parts:
Transformer (excl.)

Versions:
crystal clear

Art. No.:
114961

Recommended bulb:
35W, 2700K, 595lm
512235





GRID Design by CDC

12~

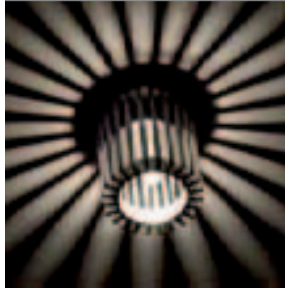

Socket/Bulb:
GY6,35/pin socket (excl.)
50W max.

Material:
Aluminium

Dimensions:
visible-Ø/H: 7/7 cm

Accessory/Included parts:
Transformer (excl.)

Versions:
alu natural

Art. No.:
134234

Recommended bulb:
50W, 2700K, 900lm
512250



CRYSTAL 1

12~

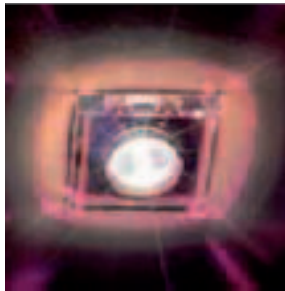

Socket/Bulb:
GU5,3/MR16 (excl.)
35W max.

Material:
Steel/crystal glass

Dimensions:
visible L/W/H:
10,2/10,2/2,7 cm

Accessory/Included parts:
Transformer (excl.)

Versions:
chrome/crystal clear

Art. No.:
114920

Recommended bulb:
35W, 40°, 2700K, 810cd
535338



CRYSTAL 2

12~

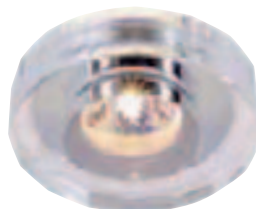
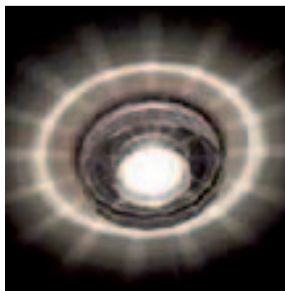

Socket/Bulb:
GU5,3/MR16 (excl.)
35W max.

Material:
Steel/crystal glass

Dimensions:
visible-Ø/H: 10/2,7 cm

Accessory/Included parts:
Transformer (excl.)

Versions:
chrome/crystal clear

Art. No.:
114921

Recommended bulb:
35W, 40°, 2700K, 810cd
535338



CRYSTAL 4

12~

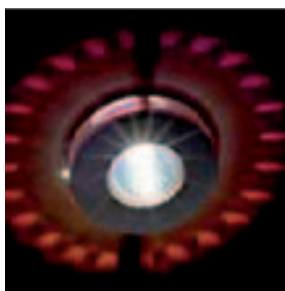

Socket/Bulb:
GU5,3/MR16 (excl.)
35W max.

Material:
Aluminium/crystal glass

Dimensions:
visible-Ø/H: 9,2/2,8 cm

Accessory/Included parts:
Transformer (excl.)

Versions:
metal brushed/
crystal clear

Art. No.:
114923

Recommended bulb:
35W, 40°, 2700K, 810cd
535338



Recommended connection:
FN Mini transformer 1, 10-60VA
461060



Recommended connection:
FN E-Transformer 04, 50-210VA
461217



Recommended connection:
IV distribution block 6-fold
410140





BAGUS

12~



8,2



14,5



0,3



IP65



Socket/Bulb:
GU5,3/MR16 (excl.)
35W max.

Versions:
Glass satined
chrome

Art. No.:
111532



Material:
Aluminium/glass

Dimensions:
Cover-Ø/H: 9,5/1,5 cm

Recommended bulb:
35W, 38°, 2700K, 810cd
536338



Accessory/Included parts:
Transformer (excl.)

DISC DOWNLIGHT

12~



8,3



8



0,35



Socket/Bulb:
GU5,3/MR16 (excl.)
50W max.

Versions:
white

Art. No.:
114701

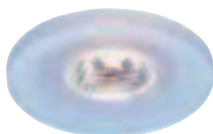

Material:
Steel/glass

Dimensions:
Cover-Ø: 10 cm

Recommended bulb:
50W, 40°, 2700K, 1500cd
536540



Accessory/Included parts:
Transformer (excl.)

SATINA

12~



10,5



8



350°



40°



0,5



Socket/Bulb:
G5,3/MR16 (excl.)
50W max.

Versions:
white

Art. No.:
114901

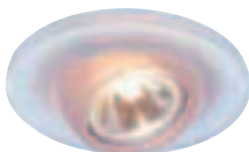

Material:
Glass

Dimensions:
Cover-Ø: 12 cm

Recommended bulb:
50W, 40°, 2700K, 1500cd
536540



Accessory/Included parts:
Transformer (excl.)

NEW TRIA, ROUND, QRB111

12~



15



12,5



360°



30°



0,23



alu brushed

matt white
with PowerLED Bulb (550132)

Socket/Bulb:
G53/QRB111 (excl.)
75W max.

Versions:
alu brushed
matt white

Art. No.:
111370
113530

Material:
Aluminium

Dimensions:
Cover-Ø: 16,5 cm

Recommended bulb:
50W EnergySaver ≠ 75W
545753 40°, 3000K, 2000cd



Accessory/Included parts:
Transformer (excl.)

HORN QRB111

12~



16,2



12,5



0,3



Socket/Bulb:
G53/QRB111 (excl.)
75W max.

Versions:
white

Art. No.:
112931



Material:
Steel

Dimensions:
Ø/H: 17,2/12,5 cm

Recommended bulb:
50W EnergySaver ≠ 75W
3000K
545752 24°, 5800cd
545753 40°, 2000cd



Accessory/Included parts:
Transformer (excl.)



Recommended connection:
FN Mini transformer 1, 10-60VA
461060



Recommended connection:
FN E-Transformer 04, 50-210VA
461217



Recommended connection:
IV distribution block 6-fold
410140





AIXLIGHT® MOD QRB111 low-voltage

12V



Material:
Aluminium/steel

Note:
Further transformer options can be found in the accessory range.

Recommended bulb:
50W, 45°, 2700K, 700cd
543545



Recommended connection:
Osram Mouse 150, 50-150VA
461155

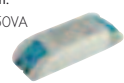

Accessory/Included parts:
Transformer (excl.)

Article No.	Description	Colour	Voltage in AC	Socket/Bulb (excl.)	Wattage Bulb	Length in cm	Width in cm	Height in cm	Installation dimensions in cm	Installation depth in cm	Rotation/Swivel range	Weight in kg	Price
154012	Aixlight® Mod 1 QRB111	silver grey	12V	G53/QRB111	50W max.	20,5	20,5	10,0	16,5/16,5	9,5	cardanic	0,85	
154022	Aixlight® Mod 2 QRB111	silver grey	12V	G53/QRB111	2x 50W max.	39,0	20,5	10,0	34,5/17,0	9,5	cardanic	1,76	
154032	Aixlight® Mod 3 QRB111	silver grey	12V	G53/QRB111	3x 50W max.	52,0	20,5	10,0	49,0/17,0	9,5	cardanic	2,35	
154042	Aixlight® Mod 4 QRB111	silver grey	12V	G53/QRB111	4x 50W max.	36,0	36,0	10,0	33,0/33,0	9,5	cardanic	3,15	

When connecting several lamps, please pay attention to the total wattage!

**NEW TRIA QRB111 low-voltage**

12~

**Material:**
Aluminium**Note:**
Further transformer options can be found in the accessory range.**Recommended bulb:**
50W EnergySaver ≈ 75W
40°, 3000K, 2000cd
545753**Recommended connection:**
Osram Mouse 150, 50-150VA
461155**Accessory/Included parts:**
Transformer (excl.)

Article No.	Description	Colour	Voltage in AC	Socket/Bulb (excl.)	Wattage Bulb	Length in cm	Width in cm	Height in cm	Installation dimensions in cm	Installation depth in cm	Rotation/Swivel range	Weight in kg	Price
111371	New Tria 1 QRB111	alu brushed	12V	G53/QRB111	75W max.	16,5	16,5	12,5	Ø 15,0	12,5	360°/30°	0,35	
113531	New Tria 1 QRB111	matt white	12V	G53/QRB111	75W max.	16,5	16,5	12,5	Ø 15,0	12,5	360°/30°	0,35	
111372	New Tria 2 QRB111	alu brushed	12V	G53/QRB111	2x 75W max.	31,5	16,5	12,5	29,7/15,5	12,5	360°/30°	0,67	
111373	New Tria 3 QRB111	alu brushed	12V	G53/QRB111	3x 75W max.	46,5	16,5	12,5	45,0/15,5	12,5	360°/30°	0,72	

When connecting several lamps, please pay attention to the total wattage!



KALU RECESSED

KALU RECESSED 1 Design by CDC



Series: Page 047, 152



Socket/Bulb:
G53/QRB111 (excl.)
50W max.

Versions:
alu brushed

Art. No.:
113406



Material:
Aluminium

Dimensions:
L/W/H: 15/9/15 cm
max. ceiling thickness: 2,5 cm

Accessory/Included parts:
Transformer (excl.)

Recommended bulb:
50W, 45°, 2700K, 700cd
543545



Recommended connection:
FN E-Transformer 01
20-60VA
461067



KALU RECESSED 2 Design by CDC



Series: Page 047, 152



Socket/Bulb:
G53/QRB111 (excl.)
2x 50W max.

Versions:
alu brushed

Art. No.:
113416



Material:
Aluminium

Dimensions:
L/W/H: 30/9/15 cm
max. ceiling thickness: 2,5 cm

Accessory/Included parts:
Transformer (excl.)

Recommended bulb:
50W, 45°, 2700K, 700cd
543545



Recommended connection:
FN E-Transformer 02
20-105VA
461107



KALU RECESSED 3 Design by CDC



Series: Page 047, 152



Socket/Bulb:
G53/QRB111 (excl.)
3x 50W max.

Versions:
alu brushed

Art. No.:
113426

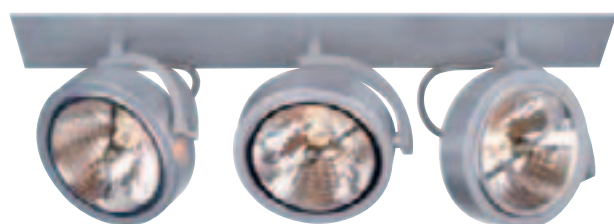

Material:
Aluminium

Dimensions:
L/W/H: 45/9/15 cm
max. ceiling thickness: 2,5 cm

Accessory/Included parts:
Transformer (excl.)

Recommended bulb:
50W, 45°, 2700K, 700cd
543545



Recommended connection:
FN E-Transformer 03
50-150VA
461157







GU10 SP

230~

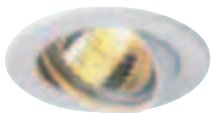

white



chrome



chrome matt



Socket/Bulb:
GU10/GU10 (excl.)
50W max.

Material:
Aluminium

Dimensions:
Cover-Ø: 8,2 cm

Versions:
white
silver grey

Art. No.:
116111
116119

chrome
titanium
chrome matt

116112
116117
116118

Recommended bulb:
35W EnergySaver ≈ 50W
20°, 2800K, 1200cd
575370



Recommended bulb:
PHILIPS PowerLED 4W
40°, 3000K, 350cd, 180lm
560014



SLIM GU10 Design by CDC

230~



Socket/Bulb:
GU10/GU10 (excl.)
35W max.

Material:
Aluminium

Dimensions:
Cover-Ø: 7 cm

Versions:
alu anodized

Art. No.:
111318

Recommended bulb:
35W EnergySaver ≈ 50W
20°, 2800K, 1200cd
575370



Recommended bulb:
PHILIPS PowerLED 4W
40°, 3000K, 350cd, 180lm
560014





FGL OUT GU10, ROUND

230~



IP44

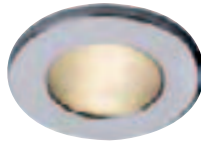

chrome

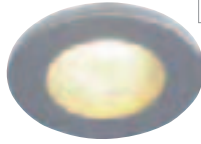

silver grey

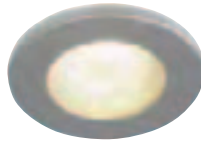

titanium



Socket/Bulb:
GU10/GU10 (excl.)
35W max.

Material:
Aluminium/glass

Dimensions:
Cover-Ø: 8 cm

Note:
Suitable for ceilings with a material
thickness of max. 15 mm.

Versions:
Glass satined
white
chrome
silver grey
titanium

Art. No.:
111021
111022
111024
111027

Recommended bulb:
35W EnergySaver \approx 50W
20°, 2800K, 1200cd
575370



HORN GU10

230~



Socket/Bulb:
GU10/GU10 (excl.)
50W max.

Material:
Steel

Dimensions:
Ø/H: 8,3/11,5 cm

Versions:
white

Art. No.:
112911

Recommended bulb:
35W EnergySaver \approx 50W
20°, 2800K, 1200cd
575370



HORN GU10 2er adjust

230~



Socket/Bulb:
GU10/GU10 (excl.)
2x 50W max.

Material:
Aluminium/steel

Dimensions:
L/W/H: 18,3/11,3/10 cm
visible-L/W/H: 18,3/11,3/0,09 cm

Versions:
matt white

Art. No.:
113111

Recommended bulb:
35W EnergySaver \approx 50W
20°, 2800K, 1200cd
575370



NEW TRIA, ROUND, GU10

230~

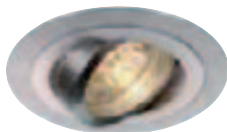

alu brushed



matt white



Socket/Bulb:
GU10/GU10 (excl.)
50W max.

Material:
Aluminium

Dimensions:
Cover-Ø: 9 cm

Versions:
alu brushed
matt white

Art. No.:
111360
113510

Recommended bulb:
35W EnergySaver \approx 50W
20°, 2800K, 1200cd
575370



TURNO GU10

230~



white

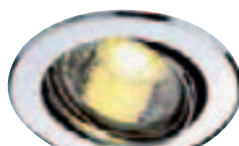

chrome



chrome matt



Socket/Bulb:
GU10/GU10 (excl.)
50W max.

Material:
Steel

Dimensions:
Cover-Ø: 9,5 cm

Versions:
white

Art. No.:
116101

chrome
chrome matt

116102
116107

Recommended bulb:
35W EnergySaver \approx 50W
20°, 2800K, 1200cd
575370



Recommended bulb:
PowerLED 4W
40°, 3000K, 350cd, 180lm
560014



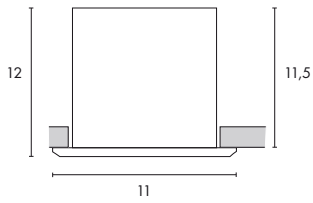

AIXLIGHT® MOD GU10 high-voltage

230~



Material:
Aluminium/steel

Recommended bulb:
35W EnergySaver ≈ 50W
20°, 2800K, 1200cd
575370



Recommended bulb:
PHILIPS PowerLED 4W
40°, 3000K, 350cd, 180lm
560014



Article No.	Description	Colour	Voltage in AC	Socket/ Bulb (excl.)	Wattage Bulb	Length in cm	Width in cm	Height in cm	Installation dimensions in cm	Installation depth in cm	Rotation/ Swivel range	Weight in kg	Price
154552	Aixlight® Mod 1 GU10	silver grey	230V	GU10/GU10	50W max.	13,5	13,5	11,5	11,0/11,0	12,0	cardanic	0,62	
154562	Aixlight® Mod 2 GU10	silver grey	230V	GU10/GU10	2x 50W max.	28,5	13,5	11,5	26,0/11,0	12,0	cardanic	0,90	
154572	Aixlight® Mod 3 GU10	silver grey	230V	GU10/GU10	3x 50W max.	40,5	13,5	11,5	38,0/11,0	12,0	cardanic	1,60	
154582	Aixlight® Mod 4 GU10	silver grey	230V	GU10/GU10	4x 50W max.	23,0	23,0	11,5	20,0/20,0	12,0	cardanic	2,35	



NEW TRIA GU10 high-voltage

230~



Material:
Aluminium

Recommended bulb:
35W EnergySaver ≈ 50W
20°, 2800K, 1200cd
575370



Recommended bulb:
PHILIPS PowerLED 6W
40°, 3000K, 600cd, 320lm
560104



Article No.	Description	Colour	Voltage in AC	Socket/ Bulb (excl.)	Wattage Bulb	Length in cm	Width in cm	Height in cm	Installation dimensions in cm	Installation depth in cm	Rotation/ Swivel range	Weight in kg	Price
1113511	New Tria 1 GU10	matt white	230V	GU10/GU10	50W max.	9,0	9,0	12,5	∅ 8,0	17,0	360°/30°	0,20	
111361	New Tria 1 GU10	alu brushed	230V	GU10/GU10	50W max.	9,0	9,0	12,5	∅ 8,0	17,0	360°/30°	0,20	
111362	New Tria 2 GU10	alu brushed	230V	GU10/GU10	2x 50W max.	17,0	9,0	12,5	16,0/8,2	17,0	360°/30°	0,35	
111363	New Tria 3 GU10	alu brushed	230V	GU10/GU10	3x 50W max.	25,5	9,0	12,5	24,5/8,2	17,0	360°/30°	0,46	



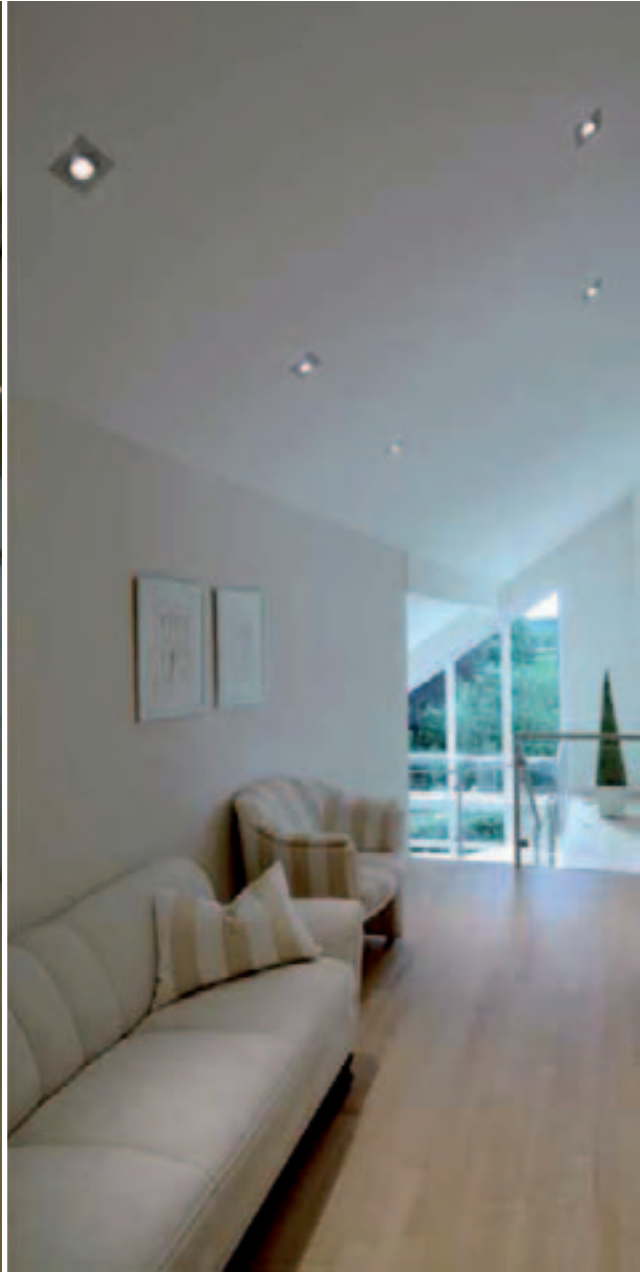

ROW 1 GU10



silver grey



white



Socket/Bulb:
GU10/GU10 (excl.)
50W max.

Material:
Aluminium

Dimensions:
Cover-L/W: 11/11 cm

Versions:
silver grey
white

Art. No.:
112561
112661

Recommended bulb:
35W EnergySaver # 50W
20°, 2800K, 1200cd
575370



INDI REC 1S GU10

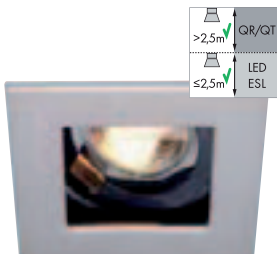

Socket/Bulb:
GU10/GU10 (excl.)
50W max.

Material:
Steel

Dimensions:
L/W/H: 10/10/11 cm

Note:
Suitable for cavity walls and ceilings
with a material thickness of
0,5-20 mm.

Versions:
silver grey/black

Art. No.:
112474

Recommended bulb:
35W EnergySaver # 50W
20°, 2800K, 1200cd
575370



Recommended bulb:
COB LED 5,6W
60°, 2700K-3000K, 300lm
551332





FGL OUT GU10, SQUARE

230~ 7 13 0,3 IP44

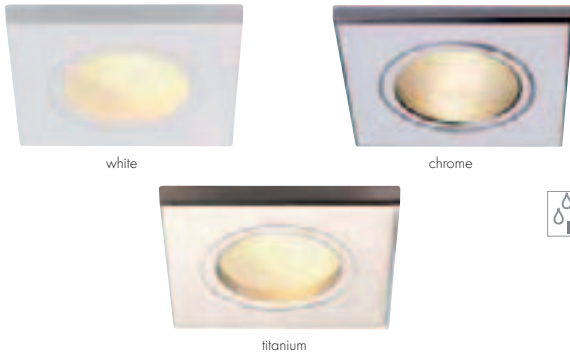

Socket/Bulb:
GU10/GU10 (excl.)
35W max.

Material:
Aluminium/glass

Dimensions:
Cover-W/L 9/9 cm

Note:
Suitable for ceilings with a material thickness of max. 15 mm.

Versions:
Glass satined
white
chrome
silver grey
titanium

Art. No.:
111141
111142
111144
111147

Recommended bulb:
35W EnergySaver \approx 50W
20°, 2800K, 1200cd
575370



GU10 SP SQUARE

230~ 7,5 12,5 90° 0,3

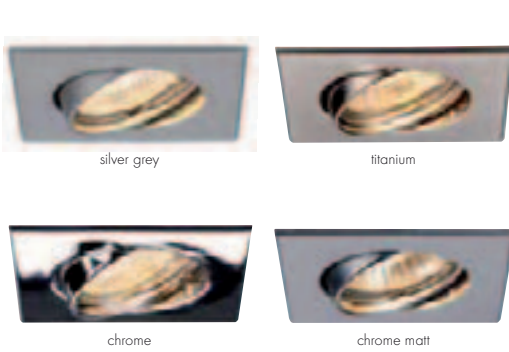

Socket/Bulb:
GU10/GU10 (excl.)
50W max.

Material:
Steel

Dimensions:
L/W/H: 9/9/12,5 cm
visible L/W/H: 9/9/0,17 cm

Versions:
white
silver grey
titanium

Art. No.:
113211
113214
113217

chrome
chrome matt 113212
113218

Recommended bulb:
35W EnergySaver \approx 50W
20°, 2800K, 1200cd
575370



Recommended bulb:
PowerLED 4W
40°, 3000K, 350cd, 180lm
560014



FRAME BASIC GU10

230~ 7,5/7,5 16 0,25



Socket/Bulb:
GU10/GU10 (excl.)
50W max.

Material:
Aluminium/glass

Dimensions:
W/H/D: 9/9/15 cm

Note:
Suitable for cavity walls and ceilings!

Versions:
silver grey

Art. No.:
111242

Recommended bulb:
35W EnergySaver \approx 50W
20°, 2800K, 1200cd
575370



Recommended bulb:
PowerLED 4W
40°, 3000K, 350cd, 180lm
560014



FRAME DISTA GU10

230~ 7,5/7,5 16 0,25

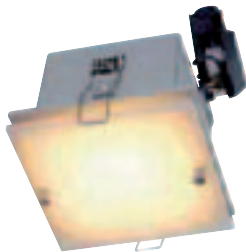

Socket/Bulb:
GU10/GU10 (excl.)
50W max.

Material:
Aluminium/glass

Dimensions:
W/H/D: 9/9/15,5 cm

Note:
Suitable for cavity walls and ceilings!

Versions:
silver grey

Art. No.:
111252

Recommended bulb:
35W EnergySaver \approx 50W
20°, 2800K, 1200cd
575370



Recommended bulb:
PowerLED 4W
40°, 3000K, 350cd, 180lm
560014



DICHRO CUBE

230~ 4,2 14,5 0,92

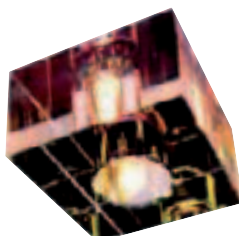
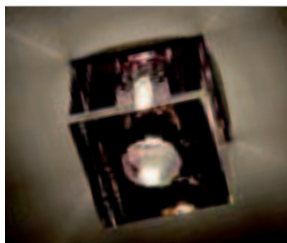

Socket/Bulb:
G9/G9 (excl.)
40W max.

Material:
Crystal glass

Dimensions:
visible-L/W/H: 8/7,8/6,5 cm

Versions:
dichroic

Art. No.:
114928

Recommended bulb:
33W, 460lm, EEK=C
519451



SLIM ES111 Design by CDC

230~



Socket/Bulb:
GU10/ES111 (excl.)
75W max.

Material:
Aluminium

Dimensions:
Cover-Ø: 13 cm

Note:
Not suitable for DomeLED ES111 bulb!

Versions:
alu anodized

Art. No.:
111328

Recommended bulb:
75W, 24°, 2700K, 2000cd
575672

NEW TRIA, ROUND, ES111

230~

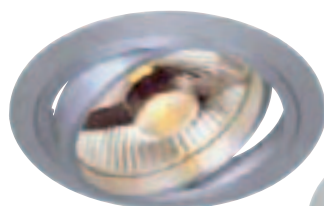

alu brushed



matt white with PowerLED bulb (550352)



Socket/Bulb:
GU10/ES111 (excl.)
75W max.

Material:
Aluminium

Dimensions:
Cover-Ø: 16,5 cm

Recommended bulb:
75W, 24°, 2700K, 2000cd
575672

Versions:
alu brushed
matt white

Art. No.:
111380
113540

Recommended bulb:
75W, 24°, 2700K, 2000cd
575672



Recommended bulb:
PowerLED 10W, 40°, 460lm
550352 warm white

HORN ES111

230~



Socket/Bulb:
GU10/ES111 (excl.)
75W max.

Material:
Steel

Dimensions:
Ø/H: 17,2/12,5 cm

Versions:
white

Art. No.:
112921

Recommended bulb:
75W, 24°, 2700K, 2000cd
575672

TROMP Downlight Design by CDC

230~



Socket/Bulb:
GU10/ES111 (excl.)
50W max.
and
2GX13/T5-Ring EnergySaver (excl.)
22W

Material:
Plastic PC

Dimensions:
Ø/H: 32/16,5 cm

Accessory/Included parts:
Electronic ballast (incl.)

Note:
ES111 bulb and T5 ring can be
switched separately.

Versions:
white

Art. No.:
111941

Recommended bulb:
50W, 2700K, 1300cd
575652



Recommended bulb:
22W, 3000K, 1900lm, EEK=A
548220









AIXLIGHT® MOD ES111 high-voltage

230~

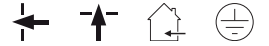
Material:
Aluminium/steelRecommended bulb:
75W, 24°, 2700K, 2000cd
575672

Article No.	Description	Colour	Voltage in AC	Socket/Bulb (excl.)	Wattage Bulb	Length in cm	Width in cm	Height in cm	Installation dimensions in cm	Installation depth in cm	Rotation/Swivel range	Weight in kg	Price
154052	Aixlight® Mod 1 ES111	silver grey	230V	GU10/ES111	75W max.	20,5	20,5	15,0	16,0/16,0	15,0	cardanic	1,05	
154062	Aixlight® Mod 2 ES111	silver grey	230V	GU10/ES111	2x 75W max.	39,0	20,5	15,0	35,5/170	15,0	cardanic	2,20	
154072	Aixlight® Mod 3 ES111	silver grey	230V	GU10/ES111	3x 75W max.	52,0	20,5	15,0	49,0/170	15,0	cardanic	2,85	
154082	Aixlight® Mod 4 ES111	silver grey	230V	GU10/ES111	4x 75W max.	36,0	36,0	15,0	32,0/32,0	15,0	cardanic	4,65	



NEW TRIA ES111 high-voltage

230~

Material:
AluminiumRecommended bulb:
75W, 24°, 2700K, 2000cd
575672

Article No.	Description	Colour	Voltage in AC	Socket/Bulb (excl.)	Wattage Bulb	Length in cm	Width in cm	Height in cm	Installation dimensions in cm	Installation depth in cm	Rotation/Swivel range	Weight in kg	Price
111381	New Tria 1 ES111	alu brushed	230V	GU10/ES111	75W max.	16,5	16,5	12,5	Ø 15,0	12,5	360°/30°	0,38	
113541	New Tria 1 ES111	matt white	230V	GU10/ES111	75W max.	16,5	16,5	12,5	Ø 15,0	12,5	360°/30°	0,38	
111382	New Tria 2 ES111	alu brushed	230V	GU10/ES111	2x 75W max.	31,5	16,5	12,5	29,7/15,5	12,5	360°/30°	0,67	
111383	New Tria 3 ES111	alu brushed	230V	GU10/ES111	3x 75W max.	46,5	16,5	12,5	45,0/15,5	12,5	360°/30°	1,04	





GX53 MOUNTING RING

230~



7,8



2



0,05

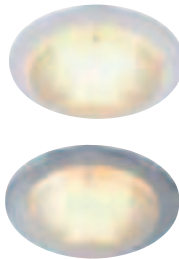

Socket/Bulb:
GX53/GX53 EnergySaver (excl.)
11W max.
or LED GX53 (excl.)
5W max.

Material:
Plastic

Dimensions:
Ø/H: 10/1,6 cm

Versions:
white
silver grey

Art. No.:
112271
112274

Recommended bulb:
9W, 2700K, 260lm
508860



Mounting socket for PowerLED GX53 and all common GX53 bulbs.

Note:
Suitable for cavity ceilings with a
material thickness of max. 12 mm.

GLASS TUBE E27

230~



8,5



12



0,62



Socket/Bulb:
E27/AGL (excl.)
60W max.
or
E27/EnergySaver (excl.)
up to max. Ø/L: 5,5/13 cm

Material:
Steel/glass

Dimensions:
visible Ø/H: 12/13 cm

Versions:
Glass satined
chrome

Art. No.:
111592

Recommended bulb:
23W, 2700K, 1350lm, EEK=A
508970



ELT DOWNLIGHT

230~



12,7



17



0,35



Socket/Bulb:
E27/EnergySaver (excl.)
up to max. Ø/L: 5,2/17,5 cm

Material:
Steel

Dimensions:
Ø/D: 14,5/17 cm

Versions:
white
silver grey

Art. No.:
152561
152564

Recommended bulb:
23W, 2700K, 1350lm, EEK=A
508970





KOTAK WALL

230~



Socket/Bulb:
E27/EnergySaver (excl.)
up to max. Ø/L: 7/17,5 cm

Material:
Aluminium/steel/glass

Dimensions:
W/H/D: 24/20,5/11 cm

Note:
Suitable for cavity walls with a
material thickness of max. 12 mm.

Versions:
Glass satined
silver grey

Art. No.:
160059

Flush-mounted frame 925251
Outer-L/W:
30,5/24,5 cm

Recommended bulb:
23W, 2700K, 1350lm, EEK=A
508970



KOTAK ELECTRONIC BALLAST

230~

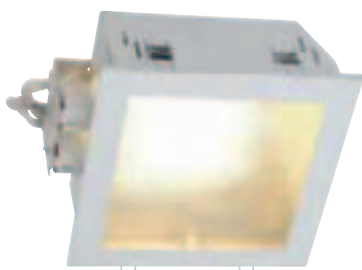

Socket/Bulb:
G24q-3/
TC-DE 4-pin EnergySaver (excl.)
2x 26W

Material:
Aluminium/glass

Dimensions:
L/W/D: 20/23/12 cm

Accessory/Included parts:
Electronic ballast (incl.)

Versions:
Glass satined
white
silver grey

Art. No.:
160041
160049

Recommended bulb:
26W, 3000K, 1800lm, EEK=B
508222



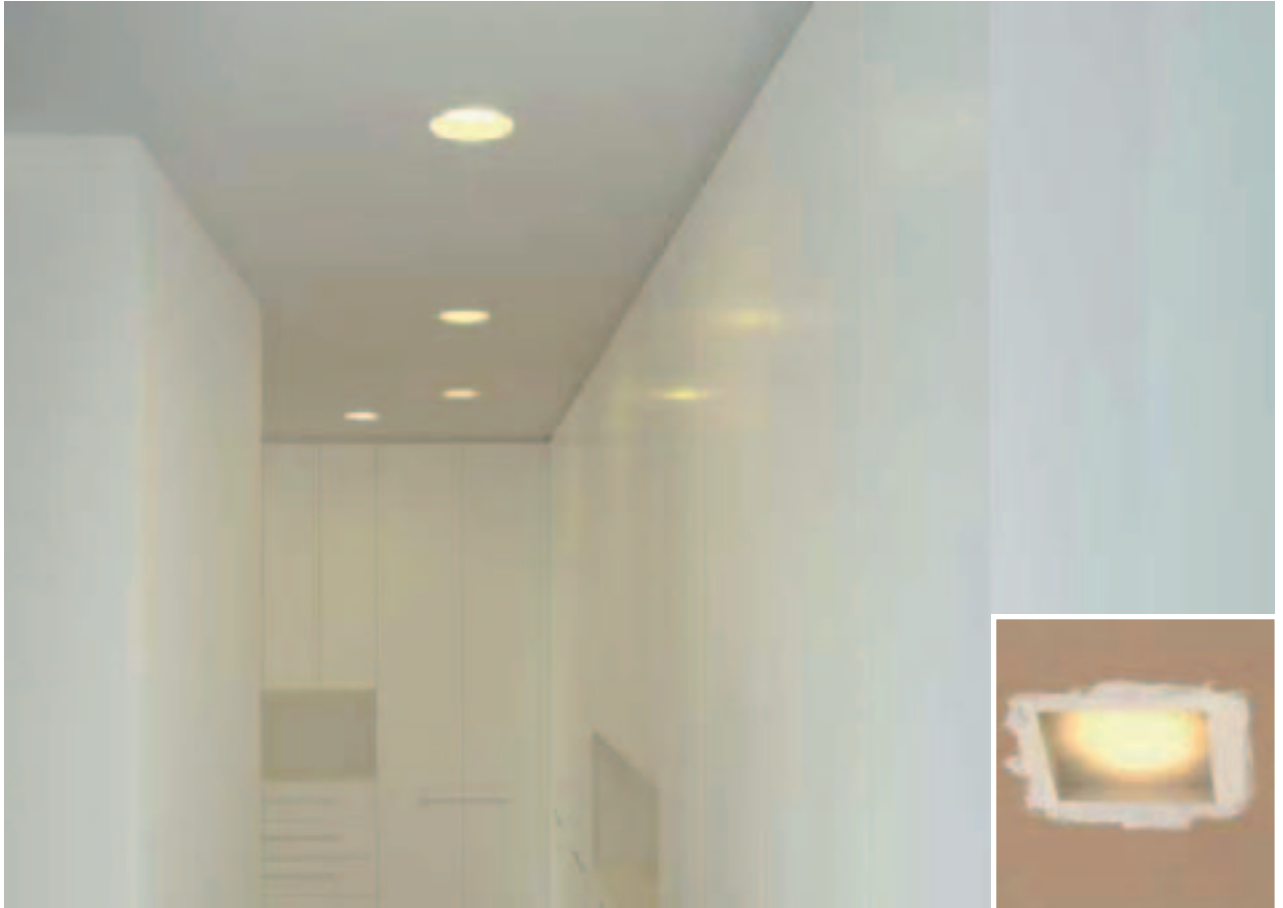

RCL 102 TC-DE FRAMELESS SET

230~

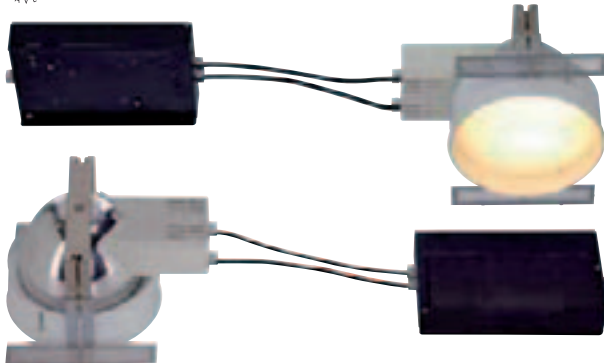
**Socket/Bulb:**

G24q-2/
TC-DE 4-pin EnergySaver (excl.)
2x18W

Material:

Aluminium/steel/plastic

Dimensions:

Ø/W/H: 18/24/15 cm

Ballast:

L/W/H: 23,5/12,5/5 cm

Connecting cable-L: 20 cm

Accessory/Included parts:

Electronic ballast (incl.)
Mounting bracket, suction cup and
screws (incl.)

Note:

Suitable for cavity ceilings with a
material thickness of 10-60 mm.

Versions:

white

Art. No.:

115480

Recommended bulb:

18W, 3000K, 1200lm, EEK=B
508220



RCL 103 TC-DE FRAMELESS SET

230~

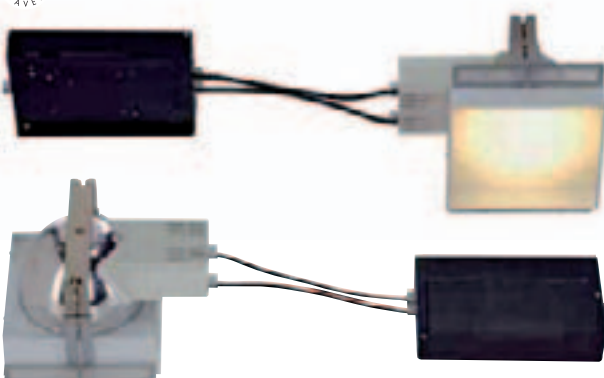
**Socket/Bulb:**

G24q-2/
TC-DE 4-pin EnergySaver (excl.)
2x18W

Material:

Aluminium/steel/plastic

Dimensions:

L/W/D: 24,5/17,7/15 cm

Ballast:

L/W/H: 23,5/12,5/5 cm

Connecting cable-L: 20 cm

Accessory/Included parts:

Electronic ballast (incl.)
Mounting bracket, suction cup and
screws (incl.)

Note:

Suitable for cavity ceilings with a
material thickness of 10-60 mm.

Versions:

white

Art. No.:

115490

Recommended bulb:

18W, 3000K, 1200lm, EEK=B
508220







PLADO 18W / 26W

230~

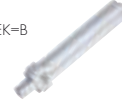
Material:
Plastic PCAccessory/Included parts:
Low-loss ballast (incl.)
Grid (incl.)Recommended bulb:
18W, 2700K, 1200lm, EEK=B
508218Recommended bulb:
26W, 2700K, 1800lm, EEK=B
508226

Article No.	Description	Colour	Voltage in AC	Socket/Bulb (excl.)	Wattage Bulb	Ø in cm	Length in cm	Height in cm	Installation-Ø in cm	Installation depth in cm	Ceiling thickness in cm	Weight in kg	Price
161501	Plado 1x18W	white	230V	G24d-2/TC-D EnergySaver	18W	20,5	35,0	13,5	19,0	13,5	0,5-3,5	1,37	
161511	Plado 2x18W	white	230V	G24d-2/TC-D EnergySaver	2x 18W	20,5	35,0	13,5	19,0	13,5	0,5-3,5	2,0	
161521	Plado 1x26W	white	230V	G24d-3/TC-D EnergySaver	26W	20,5	35,0	13,5	19,0	13,5	0,5-3,5	1,37	
161531	Plado 2x26W	white	230V	G24d-3/TC-D EnergySaver	2x 26W	20,5	35,0	13,5	19,0	13,5	0,5-3,5	2,0	

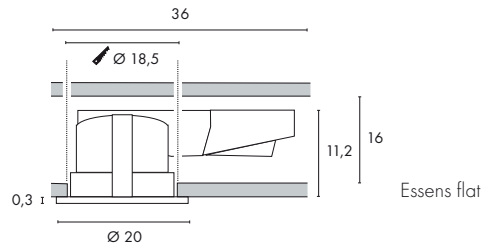

ESSENS 18W / 26W

230~

Material:
Aluminium/plasticAccessory/Included parts:
Electronic ballast (incl.)Recommended bulb:
18W, 3000K, 1200lm, EEK=B
508220Recommended bulb:
26W, 3000K, 1800lm, EEK=B
508222

Article No.	Description	Colour	Voltage in AC	IP Class	Socket/Bulb (excl.)	Wattage Bulb	Ø in cm	Length in cm	Height in cm	Installation-Ø in cm	Installation depth in cm	Cavity ceiling thickness in cm	Weight in kg	Price
161641	Essens, flat 2x18W	white	230V	-	G24q-2/TC-DE 4pin EnergySaver	2x 18W	20,0	36,0	11,5	18,5	19,0	up to max. 3,0	1,0	
161651	Essens, flat 2x26W	white	230V	-	G24q-3/TC-DE 4pin EnergySaver	2x 26W	20,0	36,0	11,5	18,5	19,0	up to max. 3,0	1,0	
161741	Essens, deep 2x18W	white	230V	IP44	G24q-2/TC-DE 4pin EnergySaver	2x 18W	20,0	36,0	15,5	18,5	20,5	up to max. 3,5	1,4	
161751	Essens, deep 2x26W	white	230V	IP44	G24q-3/TC-DE 4pin EnergySaver	2x 26W	20,0	36,0	15,5	18,5	20,5	up to max. 3,5	1,4	

RAPIDO 2x 26W ELECTRONIC BALLAST

230~

Socket/Bulb:
G24q-3/TC-DE EnergySaver (incl.)
2x 26WMaterial:
Aluminium/plasticDimensions:
Cover-Ø: 23 cm
Housing-L/W/H: 30/19/14 cmAccessory/Included parts:
Osram electronic ballast (incl.)
Darklight grid (incl.)
2x Bulb 3000K, EEK=B (incl.)Versions:
silver greyArt. No.:
161326

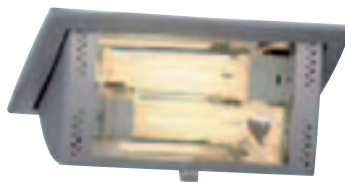

2x 13W white | 160011 |
2x 13W silver grey | 160019 |



2x 26W white | 160031 |
2x 26W silver grey | 160039 |

TC DL 2x 13W / 2x 26W ELECTRONIC BALLAST

230~



Material:
Aluminium

Accessory/Included parts:
Electronic ballast (incl.)

Recommended bulb:
13W, 3000K, 900lm, EEK=A
508212



Recommended bulb:
26W, 3000K, 1800lm, EEK=B
508222



Article No.	Description	Colour	Voltage in AC	Socket/ Bulb (excl.)	Wattage Bulb	Length in cm	Width in cm	Depth in cm	Installation dimensions in cm	Installation depth in cm	Swivel range	Weight in kg	Price
160011	TC DL 2x13W E- ballast	white	230V	G24q-1/TC-DE 4pin EnergySaver	2x 13W	23,0	14,5	13,0	12,5/21	12,0	75°	1,5	
160019	TC DL 2x13W E- ballast	silver grey	230V	G24q-1/TC-DE 4pin EnergySaver	2x 13W	23,0	14,5	13,0	12,5/21	12,0	75°	1,5	
160031	TC DL 2x26W E- ballast	white	230V	G24q-3/TC-DE 4pin EnergySaver	2x 26W	21,2	27,4	19,0	26/19,5	18,5	65°	2,1	
160039	TC DL 2x26W E- ballast	silver grey	230V	G24q-3/TC-DE 4pin EnergySaver	2x 26W	21,2	27,4	19,0	26/19,5	18,5	65°	2,1	

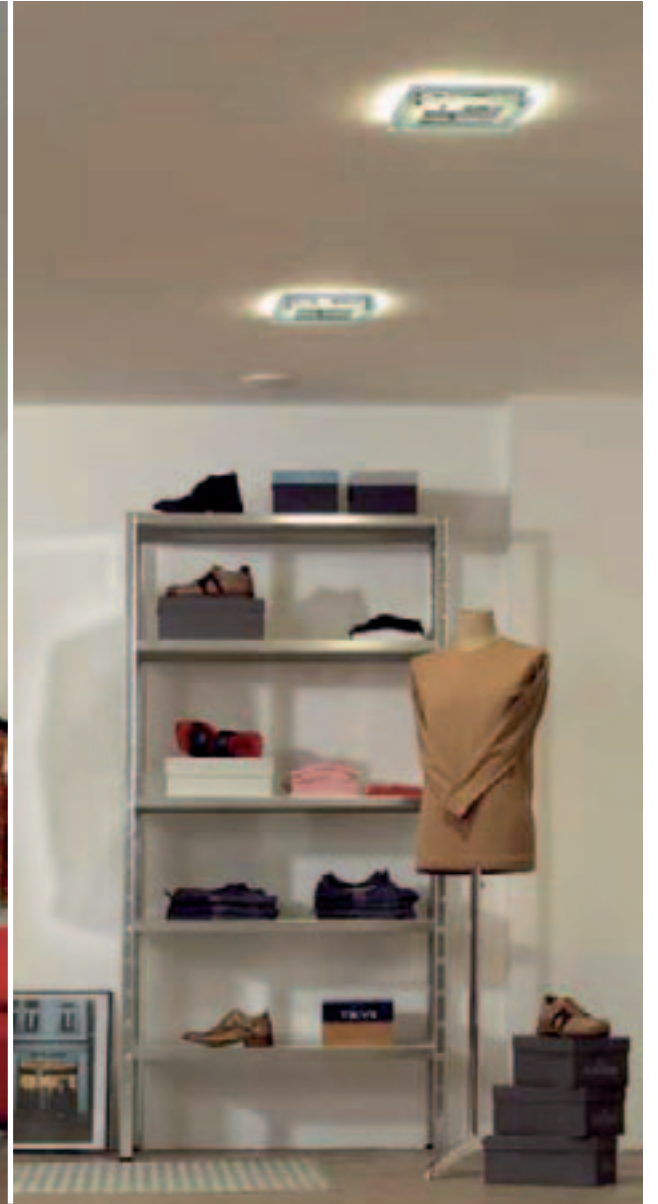

Quor 52 E-ballast white | 160021 |
 Quor 52 E-ballast silver grey | 160029 |



Quor 52/G E-ballast white/glass partial satined | 160020 |
 Quor 52/G E-ballast white/glass satined | 160022 |

QUOR 52

230~



Material:
 Aluminium/glass

Accessory/Included parts:
 Electronic ballast (incl.)

Recommended bulb:
 26W, 3000K, 1800lm, EEK=B
 508222



Article No.	Description	Colour	Voltage in AC	Socket/Bulb (excl.)	Wattage Bulb	Length in cm	Width in cm	Cover height in cm	Installation dimensions in cm	Installation depth in cm	Weight in kg	Price
160021	Quor 52 E-ballast	white	230V	G24q-3/TC-DE 4pin EnergySaver	2x 26W	23,5	23,5	-	21/21	13,0	1,5	
160029	Quor 52 E-ballast	silver grey	230V	G24q-3/TC-DE 4pin EnergySaver	2x 26W	23,5	23,5	-	21/21	13,0	1,5	
160020	Quor 52/G E-ballast	white Glass partial satined	230V	G24q-3/TC-DE 4pin EnergySaver	2x 26W	25,0	25,0	3,0	21/21	13,0	1,5	
160022	Quor 52/G E-ballast	white Glass satined	230V	G24q-3/TC-DE 4pin EnergySaver	2x 26W	25,0	25,0	3,0	21/21	13,0	1,5	



T5-BAR, 24W

230~

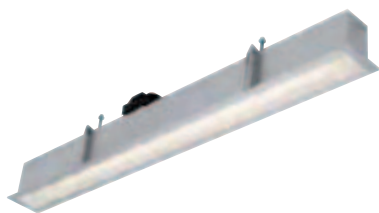

Socket/Bulb:
G5/T5 EnergySaver (excl.)
24W

Material:
Aluminium/acrylic

Dimensions:
L/W/H: 60,5/5,8/9,8 cm

Accessory/Included parts:
Electronic ballast (incl.)
Diffusor (incl.)

Versions:
alu anodized

Art. No.:
160124

Recommended bulb:
24W, 3000K, 1700lm
548024

(PU see page 661)

Only suitable for cavity walls and ceilings.

T5-BAR, 54W

230~



Socket/Bulb:
G5/T5 EnergySaver (excl.)
54W

Material:
Aluminium/acrylic

Dimensions:
L/W/H: 120,5/5,8/9,8 cm

Accessory/Included parts:
Electronic ballast (incl.)
Diffusor (incl.)

Versions:
alu anodized

Art. No.:
160134

Recommended bulb:
54W, 3000K, 4450lm
548054

(PU see page 661)

Only suitable for cavity walls and ceilings.

AIXLIGHT® PRO T5 FRAME Design by CDC

230~



Socket/Bulb:
G5/T5 EnergySaver (excl.)
2x 39W

Material:
Steel/acrylic

Dimensions:
L/W/H: 91,3/17,5/15,8 cm

Accessory/Included parts:
Electronic ballast (incl.)

Versions:
silver grey/black

Art. No.:
115204

Recommended bulb:
39W, 3000K, 3220lm
548039

(PU see page 661)

Suitable for cavity ceilings with a material thickness of 8-29 mm.

AIXLIGHT® PRO T5 FRAMELESS Design by CDC

230~



Socket/Bulb:
G5/T5 EnergySaver (excl.)
2x 39W

Material:
Steel/acrylic

Dimensions:
L/W/D: 88,5/15,5/15,5 cm

Accessory/Included parts:
Electronic ballast (incl.)
Installation frame (incl.)

Versions:
black

Art. No.:
115250

Recommended bulb:
39W, 3000K, 3220lm
548039

(PU see page 661)

Suitable for cavity ceilings with a material thickness up to max. 20 mm.





The diffuser plate is height-adjustable (approx. 2 cm) by simply loosening the screws.



GRID LAMP BIG PAN Design by CDC

230~

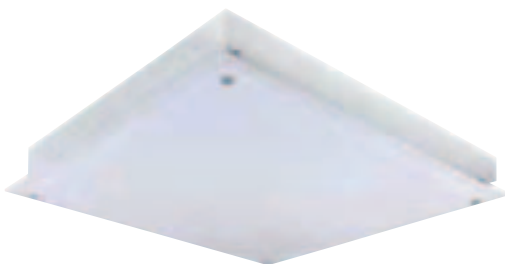

Socket/Bulb:
G13/T8 EnergySaver (excl.)
4x 18W

Material:
Acryl/steel

Dimensions:
Lamp-L/W/H: 64,5/64/11,5 cm
Acrylic plate-L/W: 64/64 cm
Distance ceiling-plate: 2 cm max.

Accessory/Included parts:
Electronic ballast (incl.)

Note:
For grid ceilings 60 x 60 cm.
With height-adjustable diffuser plate of acrylic.

Versions:
white

Art. No.:
158221

Grid lamp adapter:
For fitting into 62 x 62 cm grid ceilings 158110

Recommended bulb:
18W, 3000K, 1350lm
548202

(PU see page 661)



GRID LAMP QRB/TCL

230~
12~

Socket/Bulb:
G53/QRB111 (excl.)
3x 50W max.
and
2G11/TC-L EnergySaver (excl.)
2x 55W

Material:
Steel

Dimensions:
L/W/H: 60/60/17 cm

Accessory/Included parts:
Electronic ballast (incl.)
Electronic transformer (incl.)

Note:
For grid ceilings 60 x 60 cm.
Lamp may not be mounted within reach of hand.

Versions:
silver grey

Art. No.:
158202

Grid lamp adapter:
For fitting into 62 x 62 cm grid ceilings 158110

Recommended bulb:
55W, 2700K, 4800lm, EEK=A
508450



Recommended bulb:
50W, 45°, 2700K, 700cd
543545





LED PANEL CL 136

24=

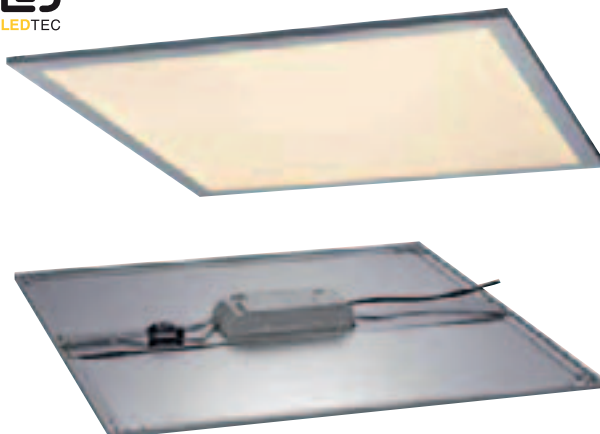

Socket/Bulb:
SMD LED
50W

Material:
Aluminium/acrylic

Dimensions:
L/W/H: 59,6/59,6/3,2 cm

Accessory/Included parts:
Power unit (excl.)
4 spacer L: 5 cm (incl.)

Note:
For grid ceilings 60 x 60 cm.

Versions:
alu anodized
white, 2500lm
warm white, 2420lm

Art. No.:
158501
158502

Grid lamp adapter:
For fitting into 62 x 62 cm
grid ceilings 158110

Recommended connection:
Power unit 60W, 24V=
470506



When connecting several lamps, please pay attention to the total wattage! Further power unit options can be found in the accessory range.

GIMBLE PRO G12



HiEFFICIENT
PROFIlight.



Socket/Bulb:
G12/HQI-T, CDM-T (excl.)
35/70/150W

Versions:
white
silver grey

Art. No.:
162021
162024

Material:
Aluminium/glass

Dimensions:
Ø/H: 18,6/15 cm

Accessory/Included parts:
Ballast (excl.)
Reflector (excl.)

Note:
Suitable for cavity ceilings with a material thickness up to max. 40 mm.
Accessory see below.

Recommended bulb:
150W, 3000K, 14000lm
507140



Recommended bulb:
150W, 3000K, 15000lm
507440



ACCESSORY for Gimble Pro



Reflector for Gimble Pro G12 Art. No.:
Aluminium chrome-plated
Ø/H: 10,75/5,3 cm 20° 162031
Ø/H: 10,75/6,3 cm 40° 162034
Ø/H: 10,75/5,4 cm 70° 162036
Design by CDC

RECOMMENDED CONNECTION for Gimble Pro



230~  **Ballast**
EEI=A2
Electronic ballast for HQI/CDM Art. No.:
Short circuit proof. 70W 470370
ta: 50°C, tc: 75°C
150W 470380
High-voltage connection
line(961062) see below

BERET G12



HiEFFICIENT
PROFIlight.

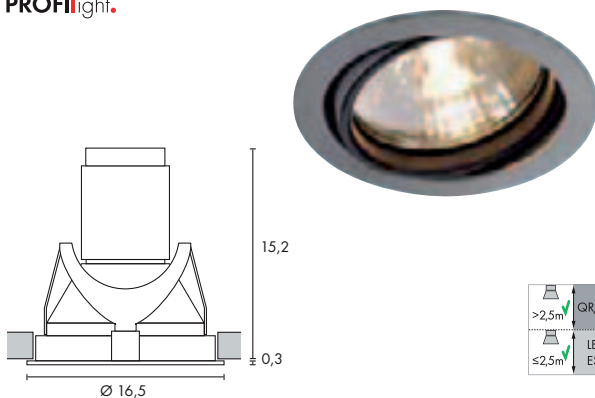

Socket/Bulb:
G12/HQI-T, CDM-T (excl.)
35/70/150W

Versions:
white
silver grey

Art. No.:
162151
162154

Material:
Aluminium

Dimensions:
Ø/H: 16,5/15,5 cm

Accessory/Included parts:
Ballast (excl.)
Reflector (excl.)

Note:
Suitable for cavity ceilings with a material thickness up to max. 40 mm.
Accessory see below.

Recommended bulb:
150W, 3000K, 14000lm
507140



Recommended bulb:
150W, 3000K, 15000lm
507440



ACCESSORY for Beret G12

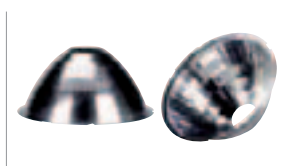

Reflector for Beret G12 Art. No.:
Aluminium chrome-plated
Ø/H: 11,3/5,3 cm 20° 162171
Ø/H: 11,3/5,3 cm 40° 162173
Ø/H: 11,3/5,3 cm 70° 162176



High-voltage connection line Art. No.:
Line-L: 2 m 961062
SO-2GMH2GJ 3x 1 mm²
Ignition voltage resistant up to 5KV.
For HQI/CDM ballasts



230~  **Ballast**
EEI=A2
Electronic ballast for HID-Bulb Art. No.:
Short circuit proof. 35W 470361
ta: 50°C, tc: 75°C
Further ballast options can be found in the
accessory range.



230~  **Ballast**
EEI=A2
Electronic ballast for HQI/CDM Art. No.:
Short circuit proof. 70W 470370
ta: 50°C, tc: 75°C
150W 470380





NEW TRIA, GX10



HiEFFICIENT
PROFIlight.

Socket/Bulb:
GX10/CMH-MR16 (excl.)
20/35W

Versions:
square
alu brushed

Art. No.:
111451

Versions:
round
alu brushed

Art. No.:
111450

Material:
Aluminium

mat white

113521

mat white

113520

Dimensions:
Lamp-H: 10 cm
Cover-Ø: 9 cm (round)
Cover-L/W: 9/9 cm (square)

Accessory/Included parts:
Electronic ballast (excl.)

Recommended connection:
E.- ballast 20W for HID-Bulb
470350

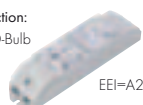

Recommended bulb:
40°, 3000K
507240 20W, 1500cd
507340 35W, 3000cd



Note:
Further ballasts can be found in the accessory range.

Recommended connection:
E.- ballast 35W for HID-Bulb
470361



Recommended connection:
HV connection line
961062



NEW TRIA, G12



HiEFFICIENT
PROFIlight.

Socket/Bulb:
G12/HQI-T; CDM-T (excl.)
35/70W

Accessory/Included parts:
Reflector 38° (incl.)
Ballast (excl.)

Material:
Aluminium

Note:
Further ballasts can be found in the accessory range.

Dimensions:
Lamp-H: 20 cm
Cover-Ø: 16,5 cm (round)
Cover-L/W: 16,5/16,5 cm (square)
Max. ceiling thickness: 2 cm

Versions:
alu brushed
round
square

Art. No.:
111680
111681

Recommended connection:
E.- ballast 70W for
HQI/CDM
470370

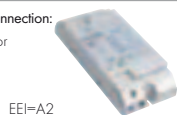

Recommended bulb:
70W, 3000K, 6600lm
507130



Recommended connection:
E.- ballast 35W for HID-Bulb
470361



Recommended connection:
HV connection line
961062

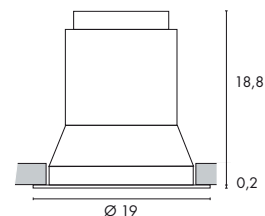
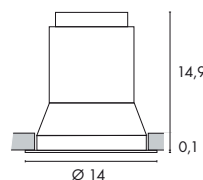
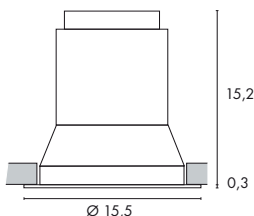
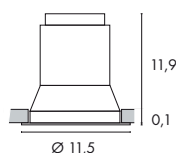

PROFIEFFICIENT
light.GU6,5 white | 162101 |
GU6,5 silver grey | 162104 |PROFIEFFICIENT
light.GU6,5 deep/white | 162121 |
GU6,5 deep/silver grey | 162124 |PROFIEFFICIENT
light.G12 white | 162111 |
G12 silver grey | 162114 |PROFIEFFICIENT
light.G12 deep/white | 162131 |
G12 deep/silver grey | 162134 |

DIVIS GU6,5/G12



Material:
AluminiumNote:
Deep reflector for glare limitation.Recommended bulb:
35W, 4200K, 3400lm
507031Recommended bulb:
150W, 3000K, 14000lm
507140Accessory/Included parts:
Electronic ballast (excl.)
Reflector (excl.)

Article No.	Description	Colour	Socket/ Bulb (excl.)	Wattage Bulb	Ø in cm	Height in cm	Installation dimensions in cm	Installation depth in cm	Weight in kg	Price
162101 ▼	DIVIS GU6,5 Downlight	white	GU6,5/CMHTC	20/35W	11,5	12,0	Ø 10,5	12,0	0,34	
162104 ▼	DIVIS GU6,5 Downlight	silver grey	GU6,5/CMHTC	20/35W	11,5	12,0	Ø 10,5	12,0	0,34	
162121 ▼	DIVIS GU6,5 Downlight deep	white	GU6,5/CMHTC	20/35W	15,5	15,5	Ø 14,8	15,5	0,62	
162124 ▼	DIVIS GU6,5 Downlight deep	silver grey	GU6,5/CMHTC	20/35W	15,5	15,5	Ø 14,8	15,5	0,62	
Suitable for cavity ceilings with a material thickness up to max. 30 mm.										
162111 ▼	DIVIS G12 Downlight	white	G12/HQI-T;CDM-T	35/70/150W	14,0	15,0	Ø 13,0	15,0	0,48	
162114 ▼	DIVIS G12 Downlight	silver grey	G12/HQI-T;CDM-T	35/70/150W	14,0	15,0	Ø 13,0	15,0	0,48	
162131 ▼	DIVIS G12 Downlight deep	white	G12/HQI-T;CDM-T	35/70/150W	19,0	19,0	Ø 18,0	24,0	0,78	
162134 ▼	DIVIS G12 Downlight deep	silver grey	G12/HQI-T;CDM-T	35/70/150W	19,0	19,0	Ø 18,0	24,0	0,78	
Suitable for cavity ceilings with a material thickness up to max. 40 mm. When using bulbs >70W, not suitable for fastening on normal flammable surfaces.										

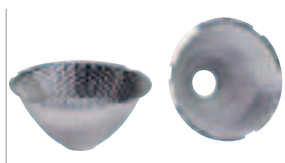
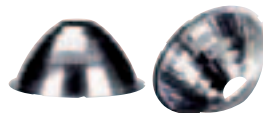
ACCESSORY for Divis GU6,5 and Divis G12

Reflector for Divis GU6,5
Aluminium chrome-plated
Ø/H: 8,8/4,2 cm 16° 162161
Ø/H: 8,8/4,2 cm 70° 162166Reflector for Divis G12
Aluminium chrome-plated
Ø/H: 11,3/5,3 cm 20° 162171
Ø/H: 11,3/5,3 cm 40° 162173
Ø/H: 11,3/5,3 cm 70° 162176

RECOMMENDED CONNECTION for Divis GU6,5 and Divis G12

230~ 
Electronic ballast for HID-Bulb Art. No.:
Short circuit proof. 35W 470361
ta: 50°C, tc: 75°C230~ 
Electronic ballast for HQI/CDM Art. No.:
Short circuit proof. 70W 470370
ta: 50°C, tc: 75°CHigh-voltage connection line Art. No.:
Line-L: 2 m 961062
SO-2GMH2G-J 3x 1 mm2
Ignition voltage resistant up to 5KV.
For HQI/CDM ballasts.

Further ballasts can be found in the accessory range

HORN ADJUST Design by CDC
HiEFFICIENT
PROFIlight.

Socket/Bulb:
 G12/CDM-T; HQI-T (excl.)
 35/70W

Versions:
 silver grey

Art. No.:
 112944

Various setting positions:
 Inboard (roof level)
 Extracted (max. 6 cm) with 30°
 swivel range.

Material:
 Steel

Dimensions:
 Lamp-Ø/H: 17/20 cm
 visible H: max. 6,5 cm
 (extracted condition)

Accessory/Included parts:
 Ballast (excl.)

Note:
 Suitable for cavity ceilings with a
 material thickness up to max. 30 mm.
 Suitable accessory like E-ballast and
 HV connection line see page 429.

Recommended bulb:
 70W, 3000K, 6600lm
 507130

Recommended connection:
 E-ballast 70W,
 for HQI/CDM
 470370

EEI=A2

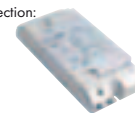

ESSENS HQI 70W

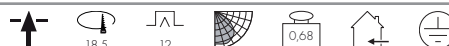
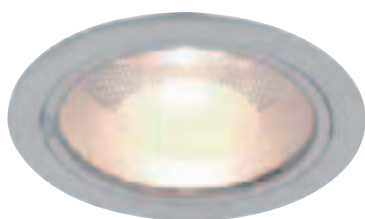
HiEFFICIENT
PROFIlight.

Socket/Bulb:
 RX7s/HQI-TS; CDM-TS (excl.)
 70W

Versions:
 white
 silver grey

Art. No.:
 162301
 162304

Material:
 Aluminium/glass

Dimensions:
 Ø/H: 20/12 cm

Accessory/Included parts:
 Ballast (excl.)

Recommended bulb:
 70W, 3000K, 6000lm
 509070

Recommended connection:
 E-ballast 70W for
 HQI/CDM
 470370

EEI=A2

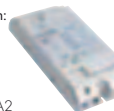
Note:
 Suitable for cavity ceilings with a material thickness up to max. 40 mm.
 Suitable accessory like electronic ballast and HV connection line see page 431.

ESSENS HQI 150W

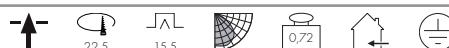
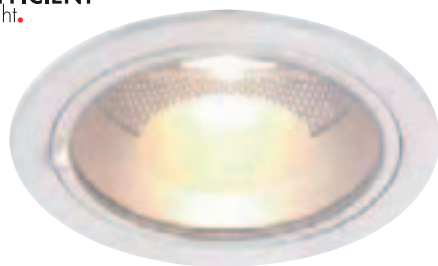
HiEFFICIENT
PROFIlight.

Socket/Bulb:
 RX7s/HQI-TS; CDM-TS (excl.)
 150W

Versions:
 white
 silver grey

Art. No.:
 162311
 162314

Material:
 Aluminium/glass

Dimensions:
 Ø/H: 24,2/15,5 cm

Accessory/Included parts:
 Ballast (excl.)

Recommended bulb:
 150W, 3000K, 12000lm
 509150

Recommended connection:
 Electronic ballast 150W for
 HQI/CDM
 470380

EEI=A2

Note:
 Suitable for cavity ceilings with a material thickness up to max. 40 mm.
 Suitable accessory like electronic ballast and HV connection line see page 431.

SQUARE DL 195 G12

HiEFFICIENT
PROFIlight.

Socket/Bulb:
 G12/HQI-T; CDM-T (excl.)
 35/70W

Versions:
 silver grey

Art. No.:
 162044

Material:
 Aluminium/steel/glass

Dimensions:
 L/W/H: 19,5/19,5/20 cm

Accessory/Included parts:
 Ballast (excl.)
 Reflector 38° (incl.)

Recommended bulb:
 70W, 3000K, 6600lm
 507130

Recommended connection:
 Electronic ballast 70W for
 HQI/CDM
 470370

EEI=A2

Note:
 Suitable for cavity ceilings with a material thickness up to max. 15 mm.
 Suitable accessory like electronic ballast and HV connection line see page 429.

**PROFIEFFICIENT**
light.DL 70 white | 150921 |
DL 70 silver grey | 150929 |**PROFIEFFICIENT**
light.DL 150 white | 150931 |
DL 150 silver grey | 150939 |**HQI-TS DL 70 / 150****Material:**
Aluminium**Accessory/Included parts:**
Ballast (excl.)**Recommended bulb:**
70W, 3000K, 6000lm
509070**Recommended bulb:**
150W, 3000K, 12000lm
509150

Article No.	Description	Colour	Socket/ Bulb (excl.)	Wattage Bulb	Length in cm	Width in cm	Depth in cm	Installation dimensions in cm	Installation depth in cm	Swivel range	Weight in kg	Price
150921	HQI-TS DL 70	white	Rx7s/HQI-TS;CDM-TS	70W	13,0	14,5	23,0	12,5/21	12,0	75°	1,0	
150929	HQI-TS DL 70	silver grey	Rx7s/HQI-TS;CDM-TS	70W	13,0	14,5	23,0	12,5/21	12,0	75°	1,0	
150931	HQI-TS DL 150	white	Rx7s/HQI-TS;CDM-TS	150W	13,0	14,5	23,0	12,5/21	12,0	75°	1,0	
150939	HQI-TS DL 150	silver grey	Rx7s/HQI-TS;CDM-TS	150W	13,0	14,5	23,0	12,5/21	12,0	75°	1,0	

RECOMMENDED CONNECTIONEN for HQI-TS DL 70 and HQI-TS DL 150

230~ 
Electronic ballast for HQI/CDM Art. No.:
Short circuit proof. 70W 470370
ta: 50°C, tc: 75°C
150W 470380



High-voltage connection line Art. No.:
Line-L: 2 m 961062
SO-2GMH2G-J 3x 1 mm²
Ignition voltage resistant up to 5KV.
For HQI/CDM ballasts.



TWISTER recessed spot system

1. Select the spot basis in white, silver grey or chrome.



2. Select the frame for
- one or two lamps
- white or silver grey.

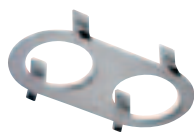

3. Select the reflector with needed angle of radiation
(Not applicable for QRB111 and ES111 modules).



4. Select the suitable bulb for the module.

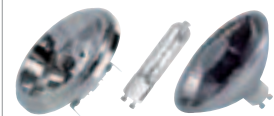

5. Select the electronic ballast or transformer suitable to the wattage of the bulb
(Not applicable for ES111 modules).

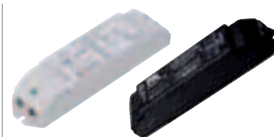

6. For GU6,5 module, the high-voltage connection line is additionally needed.







TWISTER QRB111

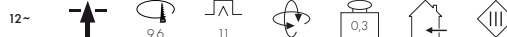

Bulb:
G53/QRB111 (excl.)
75W max.

Material:
Aluminium

Dimensions:
Ø/H: 11/17 cm

Recommended connection:
E-Trafo FN 04, 50-210VA
461217



Accessory/Included parts:
Trafo (excl.)
Frame (excl.)

Note:
Suitable for cavity ceilings with a material thickness up to max. 5-20 mm.

Recommended bulb:
50W EnergySaver ≈ 75W
545752 24°, 3000K, 5800cd
545753 40°, 3000K, 2000cd



Versions:
white
silver grey

chrome

Art. No.:
112841
112844

112842

Recommended bulb:
PowerLED 12W
24°, 3000K, 4000cd, 550lm
570003



TWISTER ES111



Bulb:
GU10/ES111 (excl.)
75W max.

Material:
Aluminium

Dimensions:
Ø/H: 11/13 cm

Accessory/Included parts:
Frame (excl.)

Note:
Suitable for cavity ceilings with a material thickness up to max. 5-20 mm.

Recommended bulb:
75W, 24°, 2700K, 2000cd
575672



Versions:
white
silver grey

chrome

Art. No.:
112851
112854

112852

Recommended bulb:
PowerLED 10W, 40°, 460lm
550352 warm white



TWISTER GU6,5



**HiEFFICIENT
PROFIlight.**

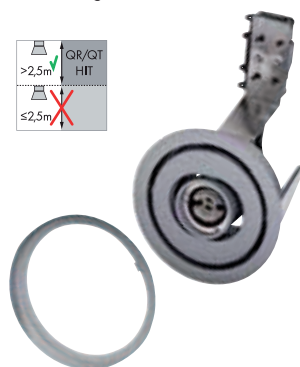

Bulb:
GU6,5/CMH-TC (excl.)
20/35W

Material:
Aluminium/steel

Dimensions:
Ø/H: 11/11,5 cm

Accessory/Included parts:
Deco ring (incl.)
Electronic ballast (excl.)
Frame (excl.)
Reflector (excl.)

Note:
Suitable for cavity ceilings with a material thickness up to max. 5-20 mm.
Further electronic ballast options can be found in the accessory range.

Recommended connection:
E-ballast 20W for HID-Bulb
470350



Versions:
white
silver grey

chrome

Art. No.:
112961
112964

112962

Recommended bulb:
35W, 4200K, 3400lm
507031



ACCESSORY for Twister GU6,5



Reflector		Art. No.:
Aluminium, chrome	12°	153721
Ø/H: 9,5/8 cm	24°	153722
	38°	153723
	60°	153726

RECOMMENDED CONNECTION for Twister GU6,5



High-voltage connection line	Art. No.:
Line-L: 2 m SO-2GMH2G-J 3x 1 mm2 Ignition voltage resistant up to 5KV. For HQL/CDM ballasts	961062

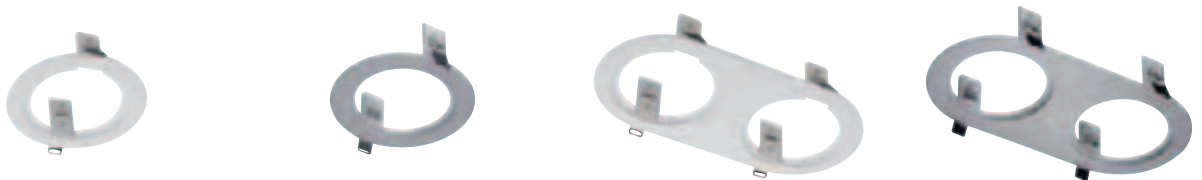

TWISTER FRAME

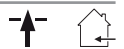

Material:
Aluminium

Note:
Suitable for cavity ceilings with a material thickness up to max. 25 mm.
Installation dimensions measured with mounted lamp.

Article No.	Description	Colour	Ø in cm	Length in cm	Width in cm	Height in cm	Installation dimensions in cm	Installation depth in cm	Material thickness Installation surface	Weight in kg	Price
112971	Twister 1 Frame round	white	15	-	-	5,5	Ø 13,5	11,0	max. 25,0 mm	0,11	
112970	Twister 1 Frame round	silver grey	15	-	-	5,5	Ø 13,5	11,0	max. 25,0 mm	0,11	
112981	Twister 2 Frame round	white	-	30,0	15,0	5,5	28,0/13,5	11,0	max. 25,0 mm	0,26	
112980	Twister 2 Frame round	silver grey	-	30,0	15,0	5,5	28,0/13,5	11,0	max. 25,0 mm	0,26	



TWISTER DOWNLIGHT-SETS

HiEFFICIENT
PROFIlight.



TWISTER - SETS



Accessory/Included parts:

Twister Downlight lamp module and frame,
Electronic ballast 1x 35W or 2x 35W,
Deco ring, reflector, high-voltage connection line

Recommended bulb:
35W, 4200K, 3400lm
507031



Article No.	Set consisting of	Colour	Wattage Bulb	Installation dimensions in cm	Weight in kg	Price
112861	Lamp module for GU6,5, chrome/1 Frame round, white/Reflector 38°/ 1m HV connection line/electronic ballast for 1x 35W	white/chrome	35W	Ø 13,5	1,2	
112871	2x lamp module for GU6,5, chrome/2 Frame round, white/2x Reflector 38°/ 2x 1m HV connection line/electronic ballast for 2x 35W	white/chrome	2x 35W	28,0/13,5	2	

Bulb (excl.)



HQI DOWNLIGHT-SETS

HiEFFICIENT
PROFILight.



HQI-SQUARE DL 195 - SET



Accessory/Included parts:

Square DL 195 G12, (incl.),
Electronic ballast HQI/CDM 70W (incl.),
Wieland GST18 5KV plug (incl.),
Wieland GST18 5KV socket (incl.),
High-voltage connection line 1m.

Recommended bulb:

70W
507130, 3000K, 6600lm
507131, 4200K, 12700lm



Article No.	Set consisting of	Colour	Wattage Bulb	Weight in kg	Price
162054	Square DL 195 70W, electronic ballast HQI/CDM 70W, Wieland GST18 5KV plug and socket Bulb (excl.)	silver grey	70W	1,9	

HiEFFICIENT
PROFILight.

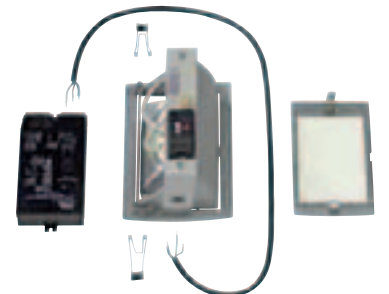

HQI-TS DL 70 / 150 - SET



Included parts:

HQI-TS DL
Electronic ballast HQI/CDM 70W or 150W
High-voltage connection line 1m

Recommended bulb:

70W
509070, 3000K, 6000lm
509071, 4200K, 6500lm



Recommended bulb:

150W
509150, 3000K, 12000lm
509151, 4200K, 12500lm



Article No.	Set consisting of	Colour	Wattage Bulb	Weight in kg	Price
150971	HQI-TS DL 70, electronic ballast HQI/CDM 70W, high-voltage connection line	white	70W	1,4	
150979	HQI-TS DL 70, electronic ballast HQI/CDM 70W, high-voltage connection line	silver grey	70W	1,4	
150981	HQI-TS DL 150, electronic ballast HQI/CDM 150W, high-voltage connection line	white	150W	1,7	
150989	HQI-TS DL 150, electronic ballast HQI/CDM 150W, high-voltage connection line	silver grey	150W	1,7	

Bulb (excl.)



OUTDOOR

Floor lights









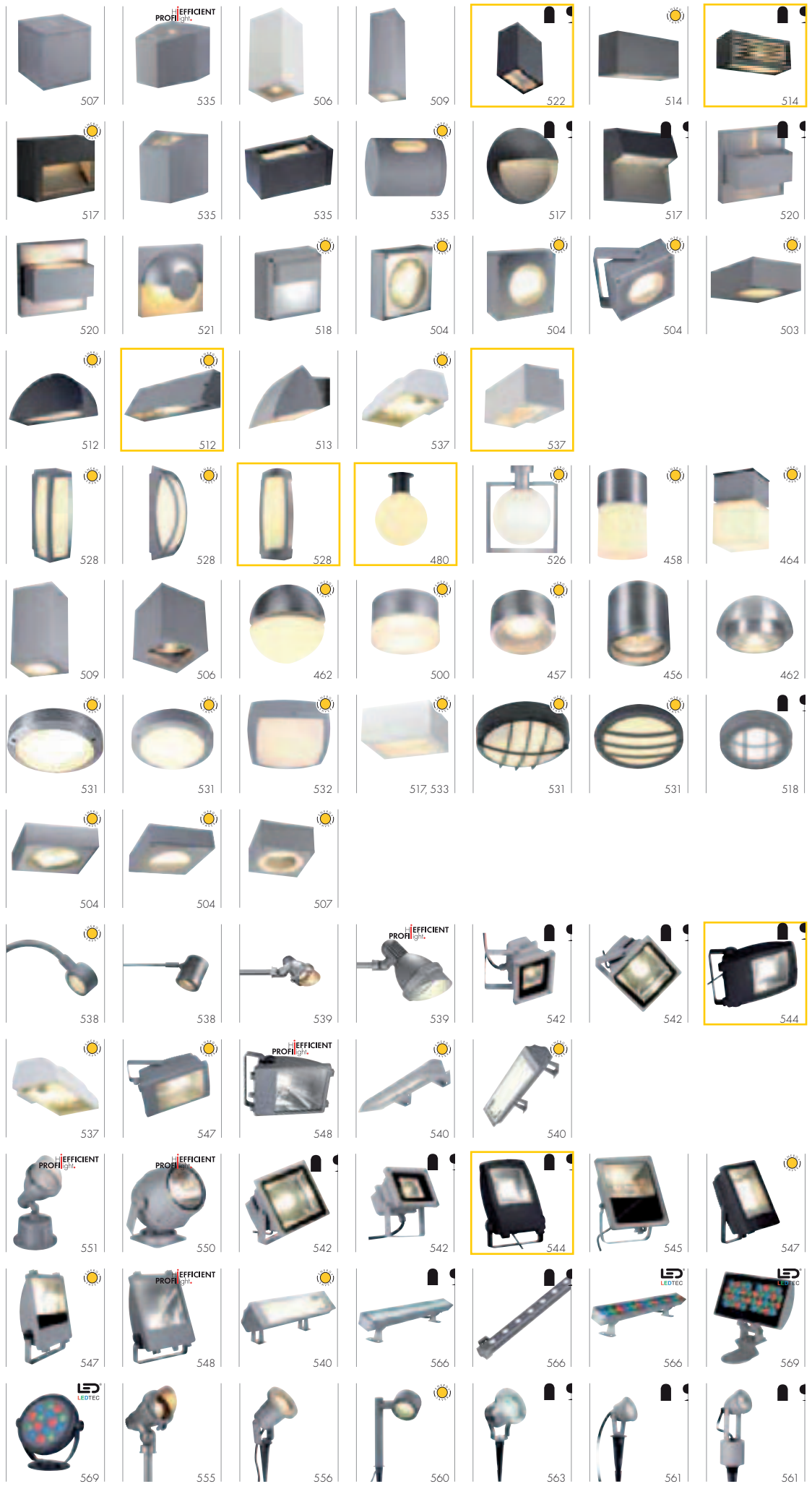



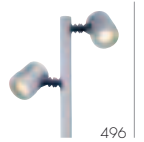







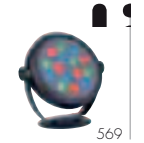



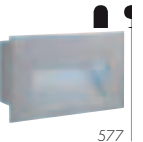

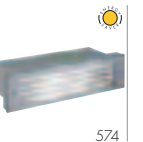

















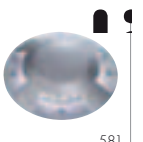
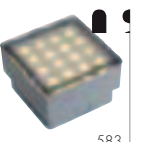





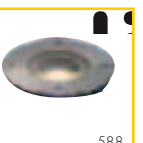





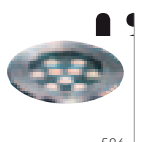
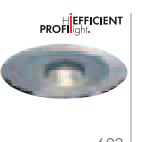









Wall luminaires

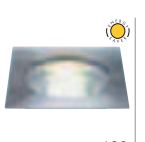
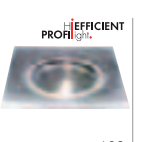
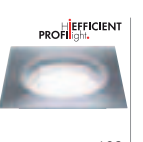
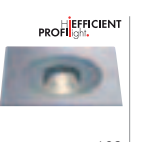
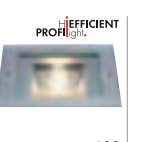

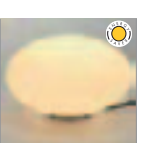

	 564	 486	 492	 496	 564	 563	 553
	 559	 563	 554	 552	 553	 569	
Recessed luminaires wall/ceiling	 575	 578	 578	 575	 577	 575	 574
	 577	 577	 575	 577	 578	 573	 571
	 582	 570	 571	 572	 572	 571, 572	 571, 572
	 592	 582	 580	 591	 581	 583	 583
 585	 585	 590	 593	 588	 588	 594	
 597	 586	 586	 586	 602	 598	 603	
 585	 588	 588	 593	 594	 595, 596	 597	
 587	 598	 600	 602	 602	 602	 603	
 601							
Light objects	 446	 445	 445				

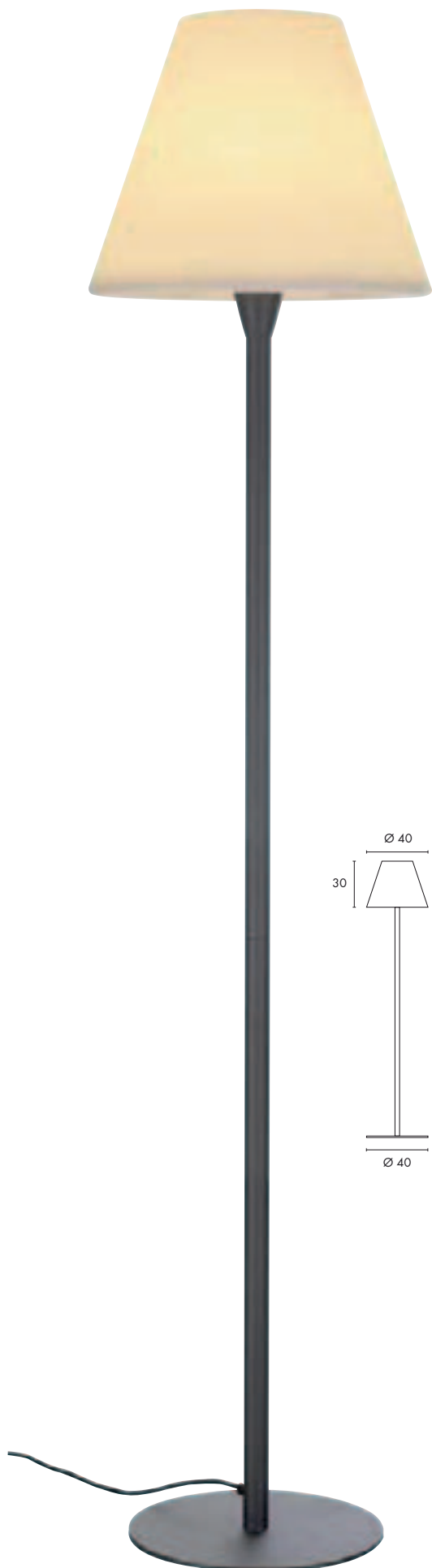

ADEGAN

Design by CDC/FGL

The IP class of the ADEGAN lamp is achieved through a closed lamp shade made of high-tensile PC. To avoid a heat accumulation in the shade, no standard bulbs may be used. The lamp may only be operated with energy-saving bulbs model ELD and ELT or smaller.

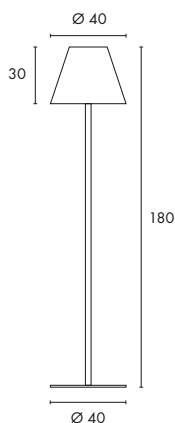

ADEGAN

Design by CDC



230~



IP54



Socket/Bulb:
E27/EnergySaver (excl.)
up to max. Ø: 5,2 cm
24W max.

Versions:
anthracite/white

Art. No.:
228965

Material:
Plastic PC/aluminium

Recommended bulb:
23W, 2700K, 1350lm, EEK=A
508970



Dimensions:
Mains cable-L: 1,8 m

Accessory/Included parts:
Mains plug (incl.)
Earth spike (excl.)

ACCESSORY for Adegan



Earth spike
Aluminium
Ø/L: 3/30 cm

Art. No.:
228960

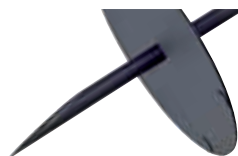

Please take note that the earth spike is only suitable for the Adegan (228965) and it will not fit on the Adegan SL. The earth spike will be screwed from the bottom into the existing base plate. With that the lamp can be speared into the lawn.



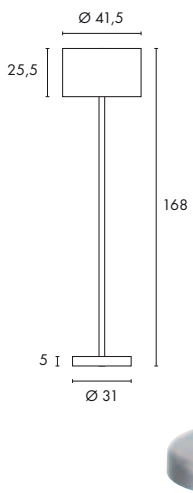

The IP classes of the ADEGAN lamps are achieved through a closed lamp shade made of high-tensile PC. To avoid a heat accumulation in the shade, no standard bulbs may be used. The lamp may only be operated with energy-saving bulbs model ELD and ELT or smaller.

ADEGAN SL

230~



IP44



Socket/Bulb:
E27/EnergySaver (excl.)
up to max. Ø/L: 6/14 cm
25W max.

Material:
Stainless steel 304/PC

Dimensions:
Mains cable-L: 1,5 m

Accessory/Included parts:
Mains plug (incl.)

Versions:
stainless steel/white

Art. No.:
228980

Recommended bulb:
23W, 2700K, 1350lm, EEK=A
508970





The Outdoor lamps DETT and Lipsy® Out Floor are translucent light objects which becomes through its classical form an eye catcher in every garden. We would like to point out that although the lamps are made of sturdy PC material, they cannot be used as seating furniture.

DETT

230~



IP54



Socket/Bulb:
E27/EnergySaver (excl.)
24W max.

Material:
LLDPE

Dimensions:
L/W/H: 30/30/32 cm
Mains cable-L: 2 m

Accessory/Included parts:
PG gland (incl.)
Mains plug (incl.)

Versions:
white

Art. No.:
227211

Recommended bulb:
PHILIPS 20W, 2700K,
1230lm, Ra82, EEK=A
508610



To avoid a heat accumulation, no standard bulbs may be used.

LIPSY® OUT FLOOR

230~



IP44



Socket/Bulb:
E27/EnergySaver (excl.)
up to max. L: 11,6 cm
23W max.

Material:
PC

Dimensions:
Product-Ø/H: 34/22 cm
Mains cable-L 2 m

Accessory/Included parts:
Mains plug (incl.)

Versions:
white

Art. No.:
227361

Recommended bulb:
15W, 2700K, 800lm, EEK=A
508960



To avoid a heat accumulation, no standard bulbs may be used.



LIGHT PIPE Design by CDC

230~



6 PowerLEDs

IP44



Bulb:
PHILIPS
 Fortimo Integrated Spot (incl.)
 13W total, 600lm

Material:
 Aluminium/acrylic

Dimensions:
 Ø/H: 10/150 cm

Versions:
 alu brushed/white
 LED white, 4000K
 LED warm white, 2700K

Art. No.:

232301

232302



ACCESSORY for Light Pipe



Earth spike
 Stainless steel 304
 Product-L: 50 cm
 Base-Ø: 18 cm
 Screws (incl.)

Art. No.:

232219

CONE

230~



IP54



Socket/Bulb:
E27/AGL, 100W max. (excl.)
or
E27/EnergySaver (excl.)
up to max. L: 15 cm

Material:
Aluminium/glass

Dimensions:
Ø/H: 19/24 cm

Versions:
silver grey
anthracite

Art. No.:
230434
230435

Recommended bulb:
23W, 2700K, 1350lm, EEK=A
508970

SQUARE TURN Floor Design by CDC

230~



IP44

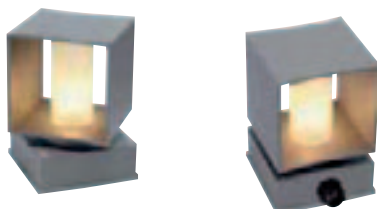

Socket/Bulb:
G9/G9 (excl.)
42W max.
or
G9/EnergySaver (excl.)
up to max. Ø/L: 3,5/8 cm
9W max.

Material:
Aluminium/glass

Dimensions:
L/W/H: 12/12/17,5 cm

Versions:
silver grey

Art. No.:
230694

Recommended bulb:
33W EnergySaver ≈ 40W
2700K, 460lm, EEK=C
519451



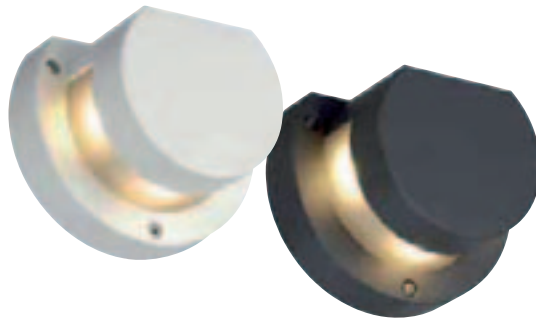

KYKLOP POLE

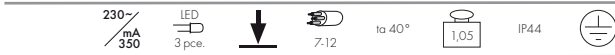

Bulb:
PowerLED (incl.)
3x 1W

Versions:
Glass satined
anthracite, LED 3000K

Art. No.:
231495

Material:
Aluminium/glass

Dimensions:
W/H/D: 13,5/18/10,6 cm

Accessory/Included parts:
LED driver (incl.)



KYKLOP WALL



Bulb:
PowerLED (incl.)
3x 1W

Versions:
Glass satined
white, LED 3000K
anthracite, LED 3000K

Art. No.:
231481
231485

Material:
Aluminium/glass

Dimensions:
W/H/D: 13,5/8,3/10,6 cm

Accessory/Included parts:
LED driver (incl.)

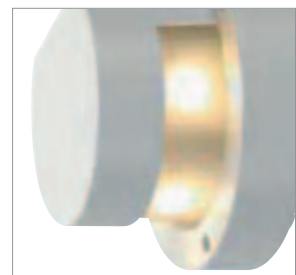

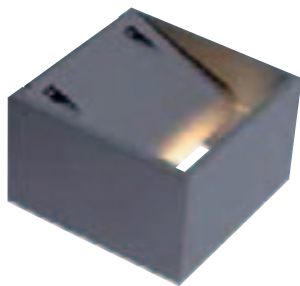
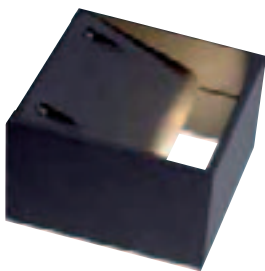
LOGS WALL

Bulb:
PlanarLED (incl.)
8W total, 250lm

Material:
Aluminium

Dimensions:
W/H/D: 13/8/13,2 cm

Accessory/Included parts:
LED driver (incl.)

Versions:
white, LED 3000K
silver grey, LED 3000K
anthracite, LED 3000K

Art. No.:
232101
232104
232105

LOGS 40 / 70

Bulb:
PlanarLED (incl.)
8W total, 250lm

Material:
Aluminium

Dimensions:
L/W/H: 13/8/39,5 cm (232114/-5)
L/W/H: 13/8/69,5 cm (232124/-5)
Base plate-L/W/H: 17/12/0,5 cm

Accessory/Included parts:
LED driver (incl.)
Screws und Dowels (excl.)

Versions:
LOGS 40
silver grey, LED 3000K
anthracite, LED 3000K

Art. No.:
232114
232115

LOGS 70
silver grey, LED 3000K
anthracite, LED 3000K

Art. No.:
232124
232125

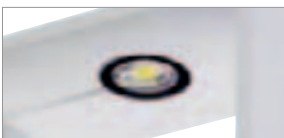

Recommended accessory:
Connection box IP68
Plastic, 3-pole
Ø/L: 2,7/11,5 cm
228730



Recommended accessory:
Screw-Set
Stainless steel
Ø/L: 0,55/3,8 cm
228754



Recommended accessory:
Earth spike
Steel galvanized
Product-L: 48 cm
231230





BACCO 70 / 90

230~



9-12

70cm
3,290cm
3,5

IP44



Socket/Bulb:
E27/EnergySaver (excl.)
up to max. Ø/L: 4,8/17 cm
15W max.

Material:
Aluminium/PC

Dimensions:
L/W/H: 21/6,6/70 cm (231325)
L/W/H: 21/6,6/90 cm (231335)
Base-L/W: 25/10,5 cm

Accessory/Included parts:
Connection box (incl.)

Versions:
Bacco 70
anthracite

Bacco 90
anthracite

Art. No.:
231325

231335

Recommended bulb:
15W, 2700K, 900lm, EEK=A
508415



Recommended accessory:
Earth spike, steel galvanized
Spike-L: 50 cm
231232





BACCO WL

230~



IP44

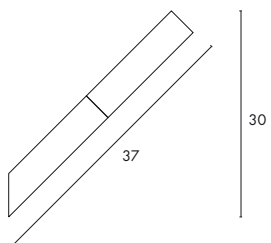
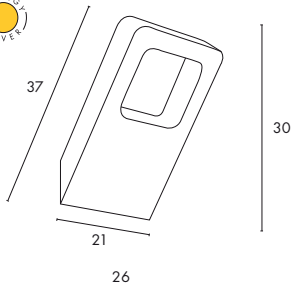

Socket/Bulb:
E27/EnergySaver (excl.)
up to max. Ø/L: 4,8/17 cm
15W max.

Material:
Aluminium/PC

Dimensions:
W/H/D: 21/30/26 cm

Accessory/Included parts:
Connection box (incl.)

Note:
Installation only with an
upward-directed angle of 45°.

Versions:
anthracite

Art. No.:
231345

Recommended bulb:
15W, 2700K, 900lm, EEK=A
508415







DELWA PATHLIGHT

230~ 4 pce. IP44

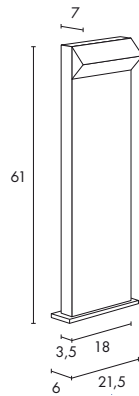

Bulb:
PowerLED (incl.)
4x 1W

Material:
Aluminium

Versions:
LED warm white, 3000K
white
anthracite

Art. No.:
232201
232205

alu brushed 232206

Recommended accessory:
Earth spike, stainless steel 304
Spike-L: 50 cm
Screws (incl.)
229841



Recommended accessory:
Concrete anchor set, Stainless steel 304
1 mounting plate,
2 anchor screws,
2 washers,
2 Cap nuts (incl.)
229840

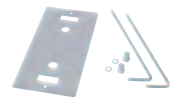

IPERI WL

230~ 4/8 IP44

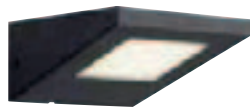
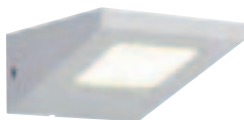

Bulb:
SMD LED (incl.)
4W total

Material:
Aluminium/plastic

Dimensions:
W/H/D: 12,5/6,5/15 cm

Accessory/Included parts:
Connection box (incl.)

Note:
Mounting only with light emission downwards.

Versions:
LED white, 4000K
white
anthracite

Art. No.:
231311
231315

IPERI 50

230~ 4/8 IP44



Bulb:
SMD LED (incl.)
4W total

Material:
Aluminium/plastic

Dimensions:
L/W/H: 17,4/12,7/50,2 cm
Base plate-L/W: 8,5/16,5 cm

Accessory/Included parts:
Connection box (incl.)

Versions:
LED white, 4000K
white
anthracite

Art. No.:
231301
231305

Recommended accessory:
Earth spike, steel galvanized
Spike-L: 50 cm
Screws (incl.)
231231





ROX PATHLIGHT

Design by CDC



ROX PATHLIGHT



Socket/Bulb:
GU10/ES111 (excl.)
50W max.

Versions:
alu brushed

Art. No.:
229836

Material:
Aluminium/glass

Dimensions:
Product-H: 61 cm
Head-Ø/H: 12,5/13,4 cm
Base-L/W/H: 21,5/5,9/1 cm

Note:
Not suitable for DomelED ES111.

Recommended bulb:
50W, 2700K, 1300cd
575652



Recommended bulb:
PowerLED 10W, 40°, 460lm
550352 warm white



ROX PATHLIGHT GX53



Socket/Bulb:
GX53/GX53 EnergySaver (excl.)
9W max.

Versions:
alu brushed

Art. No.:
229856

Material:
Aluminium/glass

Dimensions:
Product-H: 61,5 cm
Head-Ø/H: 12,5/7 cm
Base-L/W/H: 21,5/5,9/1 cm

Recommended bulb:
9W, 2700K, 260lm
508860



Recommended bulb:
3x 1,4W PowerLED
3250K, 200lm
550092



ACCESSORY for Rox Pathlight



Earth spike
Stainless steel 304
Product-L: 50 cm
Screws (incl.)

Art. No.:
229841

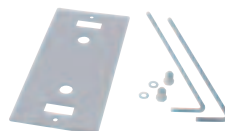

Concrete anchor set
Stainless steel 304
1 mounting plate,
2 anchor screws,
2 washers,
2 cap nuts (incl.)

Art. No.:
229840

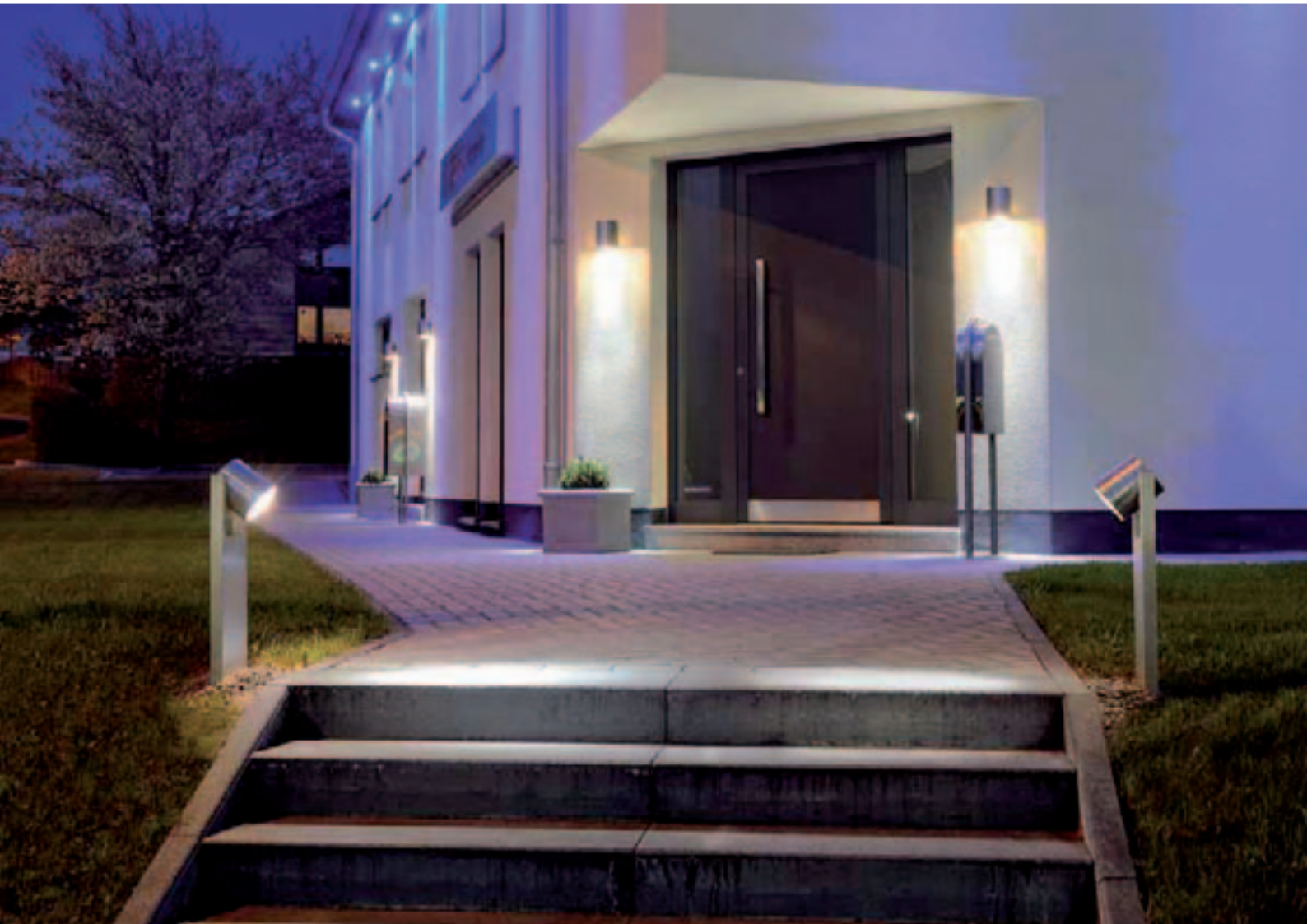



ROX CEILING OUT

230~   IP44 



Socket/Bulb:
GU10/ES111 (excl.)
75W max.

Material:
Aluminium/glass

Dimensions:
Ø/H: 12,5/12,5 cm

Versions:
alu brushed

Art. No.:
229756

Recommended bulb:
75W, 24°, 2700K, 2000cd
575672



ROX WALL OUT

230~   IP44 



Socket/Bulb:
GU10/ES111 (excl.)
75W max.

Material:
Aluminium/glass

Dimensions:
Ø/H/D: 12,5/16/13 cm

Versions:
alu brushed

Art. No.:
229766

Recommended bulb:
75W, 24°, 2700K, 2000cd
575672



ROX UP-DOWN OUT

230~   IP44 



Socket/Bulb:
GU10/ES111 (excl.)
2x 50W max.

Material:
Aluminium/glass

Dimensions:
Ø/H/D: 12,5/20,5/13 cm
Canopy-W/H/D: 5,7/7/0,5 cm

Versions:
alu brushed

Art. No.:
229776

Recommended bulb:
50W, 2700K, 1300cd
575652



ROX CEILING GX53 OUT Design by CDC

230~ IP44

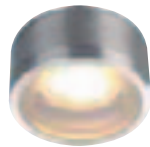
Socket/Bulb:
 GX53/GX53 EnergySaver (excl.)
 9W max.

Versions:
 alu brushed

Art. No.:
 230726

Material:
 Aluminium/glass

Dimensions:
 Ø/H: 12,5/6 cm

Recommended bulb:
 9W, 2700K, 260lm
 508860

ROX WALL GX53 OUT

230~ IP44

Socket/Bulb:
 GX53/GX53 EnergySaver (excl.)
 11W max.
 or LED GX53

Versions:
 alu brushed

Art. No.:
 229746

Material:
 Aluminium/glass

Dimensions:
 Ø/H: 12,5/14,5 cm
 Canopy-W/H/D: 5,5/7/0,5 cm

Recommended bulb:
 9W, 2700K, 260lm
 508860

ROX UP-DOWN GX53 OUT

230~ IP44

Socket/Bulb:
 GX53/GX53 EnergySaver (excl.)
 2x 9W max.
 or
 2x LED GX53, 2,8W (excl.)
 or
 2x PowerLED GX53, 3x1,4W (excl.)

Versions:
 alu brushed

Art. No.:
 229786

Material:
 Aluminium/glass

Dimensions:
 Ø/H/D: 12,5/16/13 cm
 Canopy-W/H/D: 5,5/7/0,5 cm

Recommended bulb:
 9W, 2700K, 260lm
 508860



ROX ACRYLIC C

230~ IP44

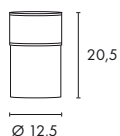

Socket/Bulb:
E27/EnergySaver (excl.)
up to max. Ø/L: 6/15 cm
20W max.

Material:
Aluminium/acrylic

Versions:
alu brushed

Art. No.:
230720

Recommended bulb:
15W, 2700K, 800lm, EEK=A
508960



ROX ACRYLIC SINGLE / ROX ACRYLIC UP-DOWN

230~ IP44



Single

Up-Down



Socket/Bulb:
E27/EnergySaver (excl.)
up to max. Ø/L: 6/17 cm
20W max./2x 20W max.

Material:
Aluminium/acrylic

Dimensions:
W/H/D: 16,5/20,5/16 cm
(230736)
W/H/D: 16,5/36,0/16 cm
(230746)

Versions:
alu brushed
Rox Acrylic Single

Art. No.:
230736

Rox Acrylic Up-Down 230746

Recommended bulb:
15W, 2700K, 800lm, EEK=A
508960



ROX ACRYLIC POLE 30 / 60 / 90

230~ IP44



Socket/Bulb:
E27/EnergySaver (excl.)
up to max. Ø/L: 6/17 cm
20W max.

Material:
Aluminium/acrylic

Dimensions:
Base-Ø: 18 cm
Ø/H: 12,5/30 cm (232256)
Ø/H: 12,5/60 cm (232266)
Ø/H: 12,5/90 cm (232276)

Versions:
alu brushed
Rox Acrylic Pole 30

Art. No.:
232256

Rox Acrylic Pole 60 232266

Rox Acrylic Pole 90 232276

Recommended bulb:
15W, 2700K, 800lm, EEK=A
508960



ACCESSORY for Rox Acrylic Pole



Earth spike
Stainless steel 304
Product-L: 50 cm
Screws (incl.)

Art. No.:
231234



Concrete anchor set
Stainless steel 304
1 mounting plate,
2 anchor screws,
2 washers,
2 cap nuts (incl.)

Art. No.:
229860





VAP SLIM 30 / 60 / 90

230~



10-13

30cm
1,560cm
2,590cm
3,2

IP44

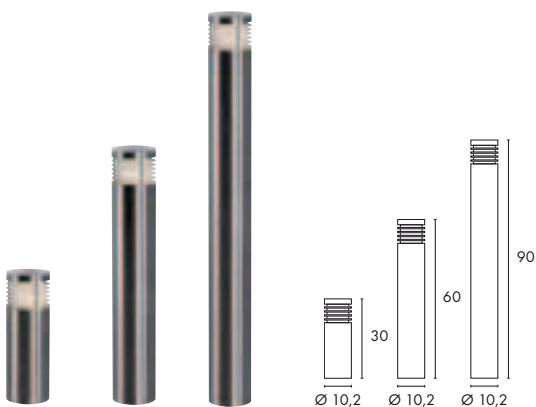

Socket/Bulb:
E27/EnergySaver (excl.)
up to max. Ø/L: 5/12,5 cm
20W max.

Material:
Stainless steel 304

Versions:
stainless steel brushed
VAP Slim 30

Art. No.:
230063

VAP Slim 60

230066

VAP Slim 90

230069

Recommended bulb:
15W, 2700K, 800lm, E27
508960



ACCESSORY for Vap Slim



Earth spike
Steel galvanized
Product-L: 48 cm
4 screws, 4 nuts,
4 washers (incl.)

Art. No.:
230060



Concrete anchor set
Stainless steel
1 mounting plate,
4 concrete anchors,
4 washers,
4 cap nuts (incl.)

Art. No.:
230061



SLOTS 300

230~ Module 1 PlanarLED to 40° 42°C 1,37 IP44



Bulb:
PHILIPS
 Fortimo LED Disk-Module (incl.)
 7,7W, 2700K, 300lm,

Versions:
 anthracite

Art. No.:
 231455

Material:
 Aluminium

Dimensions:
 Ø/H: 9/66,5 cm

Accessory/Included parts:
 Concrete anchor set (incl.)

ACCESSORY for Slots 300



Hanger bolt,
M8 Thread, 3pce. set
 Stainless steel
 Ø/L: 0,8/8 cm
 Cap nuts, dowels,
 washers (incl.)

Art. No.:
 228753



Connection box IP68
 Plastic, 3-pole
 Ø/L: 2,7/11,5 cm

Art. No.:
 228730

Specially for a safe connection in the lamp shaft.



ARCOLOS BOWL Design by CDC

230~



IP44



Socket/Bulb:
E27/EnergySaver (excl.)
up to max. Ø/L: 3,5/10,5 cm
11W max.

Material:
Aluminium/PC

Dimensions:
Ø/H: 16,3/16 cm

Versions:
alu brushed

Art. No.:
229876

Recommended bulb:
11W, 2700K, 530lm, EEK=A
508950



ARCOLOS ceiling luminaires Design by CDC

230~



IP44



Socket/Bulb:
GU10/ES111 (excl.)
50W max.

Material:
Aluminium

Dimensions:
Ø/H: 16,3/9,4 cm

Versions:
alu brushed

Art. No.:
229886

Recommended bulb:
50W, 2700K, 1300cd
575652



Note:
Not suitable for DomeLED ES111.

ARCOLOS UP BEAM ES111

230~ 7-12 87°C 3,25



The beam of light will be directed on many small convex mirrors and will be reflected indirectly onto the surface to be illuminated.



Socket/Bulb:
GU10/ES111 (excl.)
50W max.

Material:
Aluminium

Dimensions:
L/W/H: 16,4/14,4/52 cm
Base-Ø: 18 cm

Versions:
alu brushed

Art. No.:
230776

Recommended bulb:
50W, 2700K, 1300cd
575652

ARCOLOS UP BEAM LED

230~ 700 3 pce. 7-12 38°C 3,15



LEDTEC



Bulb:
PowerLED (incl.)
3x 3W

Material:
Aluminium

Dimensions:
L/W/H: 16,4/14,4/52 cm
Base-Ø: 18 cm

Accessory/Included parts:
LED converter (incl.)

Versions:
alu brushed
LED white, 6000K

Art. No.:
230786

ACCESSORY for Arcofos Up Beam

Earth spike
Stainless steel 304
Product-L: 50 cm
Screws (incl.)

Art. No.:
231234



Concrete anchor set
Stainless steel 304
1 mounting plate,
2 anchor screws,
2 washers,
2 cap nuts (incl.)

Art. No.:
229860

SQUARE C Design by CDC

230~



10



1,3

IP44

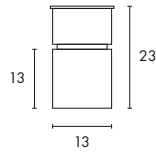

Socket/Bulb:
E27/EnergySaver (excl.)
up to max. Ø/L: 6/13 cm
20W max.

Material:
Aluminium/acrylic

Versions:
alu brushed/ varnished

Art. No.:
230716

Recommended bulb:
15W, 2700K, 800lm, EEK=A
508960

SQUARE WL Design by CDC

230~



1,2

IP44



Socket/Bulb:
E27/EnergySaver (excl.)
up to max. Ø/H: 6/13 cm
20W max.

Material:
Aluminium/acrylic

Dimensions:
W/H/D: 13/23/16,5 cm
Canopy-W/H/D: 7/5,5/3,5 cm

Versions:
alu brushed/varnished

Art. No.:
230706

Recommended bulb:
 Master Stairway ELT 15W
2700K, 850lm, Ra82, EEK=A
508600

SQUARE POLE 30 / 60 / 90 Design by CDC

230~



7-12



30cm

2,1



60cm

3,2



90cm

4,1

IP44

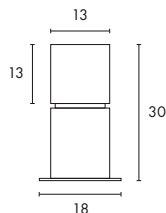

Socket/Bulb:
E27/EnergySaver (excl.)
up to max. Ø/L: 6/15 cm
20W max.

Material:
Aluminium/acrylic

Dimensions:
L/W/H: 18/18/30 cm (232236)
L/W/H: 18/18/60 cm (232246)
L/W/H: 18/18/90 cm (232249)

Versions:
alu brushed/varnished
Square Pole 30

Art. No.:
232236

Square Pole 60

232246

Square Pole 90

232249

Recommended bulb:
15W, 2700K, 800lm, EEK=A
508960

ACCESSORY for Square Pole

Earth spike
Stainless steel 304
Product-L: 50 cm

Screws (incl.)

Art. No.:
231234



Concrete anchor set
Stainless steel 304
1 mounting plate,
2 anchor screws,
2 washers,
2 cap nuts (incl.)

Art. No.:
232220

GRAFIT WL

230~



IP44

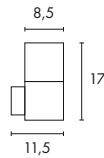

Socket/Bulb:
E27/EnergySaver (excl.)
up to max. Ø/L: 6/11,5 cm
11W max.

Material:
Aluminium/plastic

Dimensions:
Canopy-W/H/D: 6,2/6,2/3 cm

Versions:
anthracite/white

Art. No.:
231205

Recommended bulb:
11W, 2700K, 530lm, EEK=A
508950

GRAFIT SL 30 / 60

230~



IP44

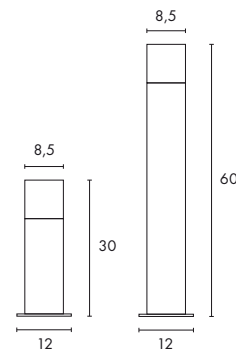

Socket/Bulb:
E27/EnergySaver (excl.)
up to max. Ø/L: 6/11,5 cm
11W max.

Material:
Aluminium/plastic

Accessory/Included parts:
Connection box (incl.)

Versions:
anthracite/white
Grafit SL 30

Art. No.:
231215

Grafit SL 60

Art. No.:
231225

Recommended bulb:
11W, 2700K, 530lm, EEK=A
508950

ACCESSORY Grafit SL 30 and SL 60

Earth spike
Steel galvanized
Product L: 48 cm

Art. No.:
231230



The lamp shades of the Grafit lamp series are
satinated and in smoked glass optic.



RUSTY – the original

The idea behind our Rusty lamp was to connect the natural aspect of a controlled surface rusting with modern energy saving technology in a very strong light fixture. All lamps of the Rusty range are made of FeCSi-steel cast steel and are extremely weather proof.

In the outdoor application the special steel alloy forms a special barrier layer of iron oxide (rust), which protects the material core from infiltration of dampness and thereby protecting it from further rusting. The flaking of the rust is hereby prevented. Individual deviations in form and surface are intended with the Rusty lamps. Each unit is unique.

Rusting is a natural process; type and colour of the outer oxidation layer can, depending on location and influence of weather, develop differently and thereby make the sensual attractiveness of this lamp. Rusty lamps materialize a bit of liveliness and individuality.

While the appearance of the round Rusty lamps recreates harbour bollards, the Rusty Square builds a visual relation to classical Japanese garden architecture. This relationship is not by coincidence, especially in Japan the cultivation and aesthetic of the perishability has a long tradition. Hereby the Rusty Square, an individual unique and changing in the course of time appearance through the rust process is a suitable counterpart for the Japanese style.

RUSTY 40 / RUSTY 70

230~



IP55

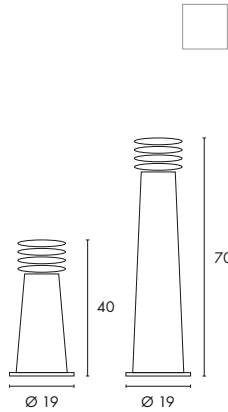

Socket/Bulb:
E27/EnergySaver (excl.)
up to max. Ø/L: 4,8/13,5 cm
11W max.

Material:
FeCSi-steel
Light surface PC

Note:
Each lamp is an unique!

Versions:
iron rusted
Rusty 40

Rusty 70

Art. No.:
229020

229021

Recommended bulb:
11W, 2700K, 580lm, EEK=A
508211

RUSTY SQUARE 40 / RUSTY SQUARE 70 Design by CDC

230~



IP55

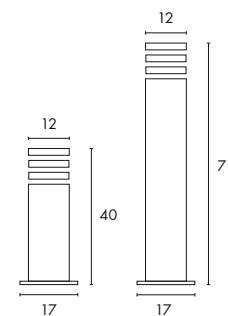

Socket/Bulb:
E27/EnergySaver (excl.)
up to max. Ø/L: 4,8/13,5 cm
11W max.

Material:
FeCSi-steel
Light surface PC

Note:
Each lamp is an unique!

Versions:
iron rusted
Rusty Square 40

Rusty Square 70

Art. No.:
229420

229421

Recommended bulb:
11W, 2700K, 580lm, EEK=A
508211

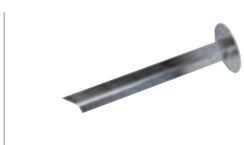
ACCESSORY for Rusty and Rusty Square

Earth spike for Rusty
Steel galvanized
Product-L: 50 cm

Art. No.:
229022



Connection box IP68
Plastic, 3-pole
Ø/L: 2,7/11,5 cm

Art. No.:
228730

Specially for a safe connection in the lamp shaft.



Earth spike for Rusty Square
Steel galvanized
Product-L: 50 cm

Art. No.:
229422

RUSTY SLOT 50 / RUSTY SLOT 80 Design by CDC

230~



IP44

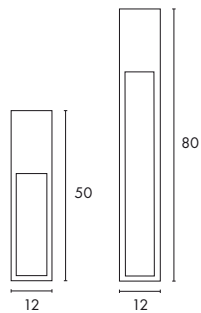

Socket/Bulb:
E27/EnergySaver (excl.)
up to max. Ø/L: 4,8/13,5 cm
11W max.

Material:
FeCSi-steel

Note:
Each lamp is an unique!

Versions:
iron rusted
Rusty Slot 50

Art. No.:
229410

Rusty Slot 80

229411

Recommended bulb:
11W, 2700K, 580lm, EEK=A
508211

ACCESSORY for Rusty Slot

Earth spike
Steel galvanized
Product-L: 48 cm

Art. No.:
231230



Connection box IP68
Plastic, 3-pole
Ø/L: 2,7/11,5 cm

Art. No.:
228730

Specially for a safe connection in the lamp shaft.





RUSTY CONE Design by CDC

230~



IP54



Socket/Bulb:
E14/EnergySaver (excl.)
up to max. Ø/L: 4,8/13,5 cm
or E14/AGL, 40W max. (excl.)

Versions:
Glass satined
iron rusted

Art. No.:
229430

Material:
FeCSi-steel
Light surface glass

Recommended bulb:
11W, 2700K, 530lm, EEK=A
508810

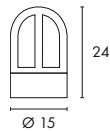

Note:
Each lamp is an unique!

RUSTY CONE 40 / RUSTY CONE 70 Design by CDC

230~



IP54



Socket/Bulb:
E27/EnergySaver (excl.)
up to max. Ø/L: 4,8/13,5 cm
11W max.

Versions:
Glass satined
iron rusted
Rusty Cone 40

Art. No.:
229431

Material:
FeCSi-steel
Light surface glass

Rusty Cone 70

229432

Note:
Each lamp is an unique!

Recommended bulb:
11W, 2700K, 580lm, EEK=A
508211

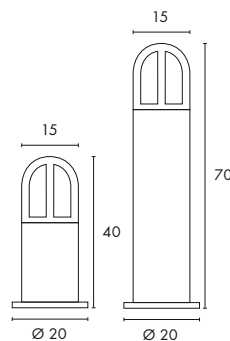
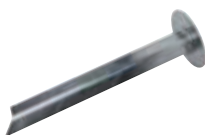
ACCESSORY for Rusty Cone 40 / Rusty Cone 70

Earth spike
Steel galvanized
Product-L: 50 cm

Art. No.:
229423



Connection box IP68
Plastic, 3-pole
Ø/L: 2,7/11,5 cm

Art. No.:
228730

Specially for a safe connection in the lamp shaft.



RUSTY PATHLIGHT Design by CDC

230~



IP44

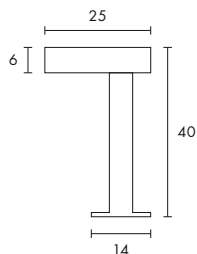

Socket/Bulb:
GX53/GX53 EnergySaver (excl.)
9W max.

Material:
FeCSi-steel
Inner housing: Aluminium

Note:
Each lamp is an unique!

Versions:
iron rusted

Art. No.:
230090

Recommended bulb:
9W, 2700K, 260lm
508860



ACCESSORY for Rusty Pathlight

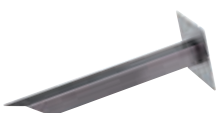

Earth spike
Steel galvanized
Product L: 50 cm

Art. No.:
229422



Connection box IP68
Plastic, 3-pole
Ø/L: 2,7/11,5 cm

Art. No.:
228730

Specially for a safe connection in the lamp shaft.



ARROCK ARC GU10

230~ IP44



Socket/Bulb:
GU10/GU10 (excl.)
35W max.
or LED GU10, 11W (excl.)

Material:
Granite, stainless steel 304

Dimensions:
W/H/D: 19/70,5/9 cm
Base plate-L/W: 9/19 cm

Note:
Granite is a natural product.
Each lamp is an unique!

Versions:
salt & pepper

Art. No.:
231420

Recommended bulb:
 LEDspot 4W
36°, 3000K, 300cd, 165lm
560084



Recommended bulb:
35W EnergySaver \approx 50W
20°, 2800K, 1200cd
575370



ACCESSORY for Arrock lamps



Earth spike
Steel galvanized
Product-L: 50 cm

Art. No.:
231233



Connection box IP68
Plastic, 3-pole
 \varnothing /L: 2,7/11,5 cm

Art. No.:
228730

Specially for a safe connection in the lamp shaft.



ARROCK SAND 40 / 70

230~



IP44

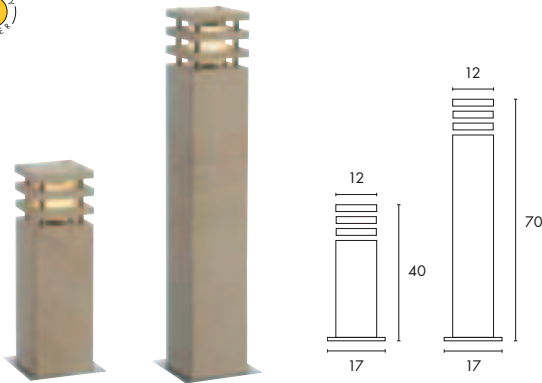

Socket/Bulb:
E27/EnergySaver (excl.)
up to max. Ø/L: 4,3/11,5 cm
15W

Material:
Sandstone, stainless steel

Note:
Sandstone is a natural product.
Each lamp is a unique!

Versions:
sandstone
Arrock Sand 40

Art. No.:
231400

Arrock Sand 70

231401

Recommended bulb:
15W, 2700K, 800lm, EEK=A
508960



ARROCK GRANITEE 40 / 70

230~



IP44

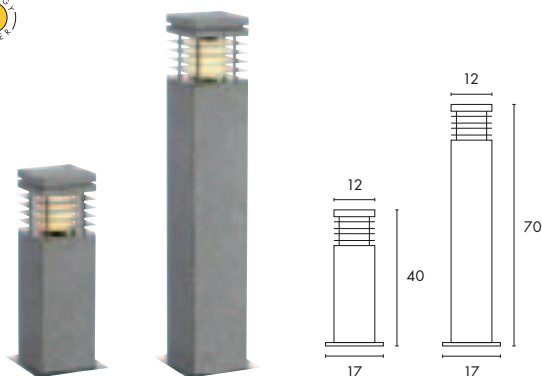

Socket/Bulb:
E27/EnergySaver (excl.)
up to max. Ø/L: 4,3/11,5 cm
15W

Material:
Granite, stainless steel

Note:
Granite is a natural product.
Each lamp is a unique!

Versions:
salt & pepper
Arrock Granitee 40

Art. No.:
231410

Arrock Granitee 70

231411

Recommended bulb:
15W, 2700K, 800lm, EEK=A
508960



ACCESSORY for Arrock lamps

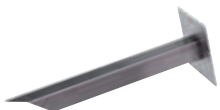

Earth spike
Steel galvanized
Product-L: 50 cm

Art. No.:
229422



Connection box IP68
Plastic, 3-pole
Ø/L: 2,7/11,5 cm

Art. No.:
228730

Specially for a safe connection in the lamp shaft.





NEW POL

 230~   3,8 IP54 

Socket/Bulb:
E27/EnergySaver (excl.)
up to max. Ø/L: 5,2/17,5 cm
25W max.

Material:
Aluminium/acrylic

Dimensions:
Ø/H: 15/76 cm
Base plate-Ø: 21,5 cm

Accessory/Included parts:
Screws (excl.)

Versions:
silver grey
anthracite

Art. No.:
227874
227845

Recommended bulb:
23W, 2700K, 1350lm, EEK=A
508970

POL IP54

 230~    3,8 IP54 

Socket/Bulb:
G24d-3/TC-D EnergySaver (excl.)
26W

Material:
Aluminium

Dimensions:
Ø/H: 13/87 cm
Base plate-Ø: 18 cm

Accessory/Included parts:
Low-loss ballast (incl.)
Screws (excl.)

Versions:
silver grey
anthracite

Art. No.:
227902
227905

Recommended bulb:
26W, 2700K, 1800lm, EEK=B
508226



The lamp shade of the corrosion-resistant POL IP54 lamp made of varnished aluminium cast consists of impact-resistant and UV-stabilized polycarbonat.

ACCESSORY for Pol IP54 and New Pol

Hanger bolt,
M8 Thread, 3pce. set
Stainless steel
Ø/L: 0,8/8 cm
Cap nuts, dowels,
washers (incl.)

Art. No.:
228753



OTOS PL

230~



IP43



Socket/Bulb:
G24d-2/TC-D EnergySaver (excl.)
18W

Material:
Aluminium/glass

Dimensions:
Ø/L: 17/100 cm

Accessory/Included parts:
Concrete anchors (incl.)
Low-loss ballast (incl.)

Versions:
silver grey
anthracite

Art. No.:
230454
230455

Recommended bulb:
18W, 2700K, 1200lm, EEK=B
508218



OTOS GLASS

230~



IP43



Socket/Bulb:
E27/EnergySaver (excl.)
up to max. Ø/L: 6,5/14,5 cm
15W max.

Material:
Aluminium/glass

Dimensions:
Ø/H: 15,5/93,5 cm

Accessory/Included parts:
Concrete anchors (incl.)

Versions:
silver grey
anthracite

Art. No.:
230464
230465

Recommended bulb:
15W, 2700K, 800lm, EEK=A
508960



ACCESSORY for Otos and Otos Glass



Hanger bolt, 3pce. set
M8 Thread
Stainless steel
Ø/L: 0,8/8 cm
Cap nuts, dowels,
washers (incl.)

Art. No.:
228753



C-POL WALL

230~ IP44



Socket/Bulb:
E27/EnergySaver (excl.)
up to max. Ø/L: 5,2/17,3 cm
24W max.

Material:
Aluminium/PC

Dimensions:
Product-Ø/H/D: 12/30/18 cm
Canopy-W/H/D: 7,7/10/7 cm

Versions:
anthracite

Art. No.:
231465

Recommended bulb:
 Master Stairway ELT 15W
2700K, 850lm, Ro82, EEK=A
508600



C-POL

230~ IP44



Socket/Bulb:
E27/EnergySaver (excl.)
up to max. Ø/L: 5,2/17,3 cm
24W max.

Material:
Aluminium/PC

Dimensions:
Product-Ø/H: 12/90 cm
Base plate-Ø: 17 cm

Versions:
anthracite

Art. No.:
231475

Recommended bulb:
 Master Stairway ELT 15W
23W, 2700K, 1350lm, EEK=A
508770



ACCESSORY for C-POL



Connection box IP68 Art. No.:
Plastic 228730
3-pole
Ø/L: 2,7/11,5 cm
Specially for a safe connection in the lamp
shaft.



GLOO PURE WALL

230~



IP44



Socket/Bulb:
E27/EnergySaver (excl.)
up to max. Ø/L: 4,8/18 cm
20W max.

Material:
Steel/glass

Dimensions:
Head-Ø: 20 cm
Canopy-Ø/D: 8/2,5 cm
Product-Ø/H/D: 20/32,5/21 cm

Versions:
Glass white
anthracite

Art. No.:
232005

Recommended bulb:

PHILIPS Master Stairway ELT 15W
2700K, 850lm, Ra82, EEK=A
508600



GLOO PURE 27 / 44 / 70

230~



IP44



Socket/Bulb:
E27/EnergySaver (excl.)
up to max. Ø/L: 4,8/18 cm
20W max.

Material:
Steel/glass

Dimensions:
Product-Ø/H: 20/27 cm (232015)
Base-Ø/H: 10/0,5 cm
Product-Ø/H: 20/44 cm (232025)
Base-Ø/H: 18/1 cm
Product-Ø/H: 20/70 cm (232035)
Base-Ø/H: 18/1 cm

Note:
Gloo Pure 27 can be used as
ceiling as well as floor lamp.

Versions:
Glass white
anthracite
Gloo Pure 27

Art. No.:
232015

Gloo Pure 44

232025

Gloo Pure 70

232035

Recommended bulb:

PHILIPS Master Stairway ELT 15W
2700K, 850lm, Ra82, EEK=A
508600



ACCESSORY for Gloo Pure



Earth spike
Stainless steel 304
Product-L: 50 cm

Art. No.:
231234



Connection box IP68
Plastic
3-pole
Ø/L: 2,7/11,5 cm
Specially for a safe connection in the lamp
shaft..

Art. No.:
228730



BERRA 30 / 50 / 70

230~



IP44

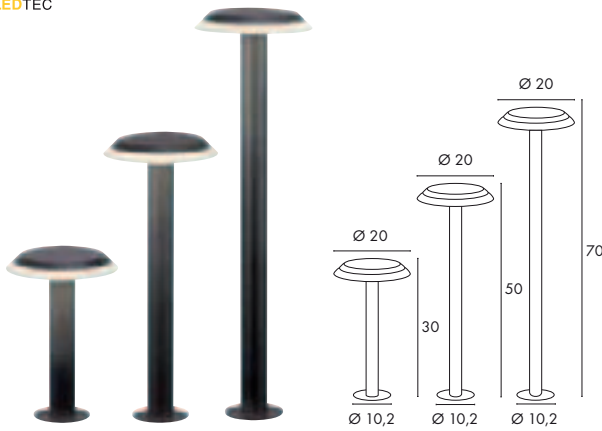

Bulb:
SMD LED (incl.)
4W total

Material:
Aluminium/plastic

Accessory/Included parts:
Connection box (incl.)

Versions:
Berra 30
anthracite

Berra 50
anthracite

Berra 70
anthracite

Art. No.:
231283

231285

231287

ACCESSORY for Berra



Earth spike
Steel galvanized
Product-L: 48 cm
4 screws, 4 nuts,
4 washers (incl.)

Art. No.:
230060



Concrete anchor set
Stainless steel
1 Mounting plate,
4 concrete anchors,
4 washers,
4 cap nuts (incl.)

Art. No.:
230061



ALPA MUSHROOM 40 / ALPA MUSHROOM 75 Design by CDC/FGL

230~



IP55

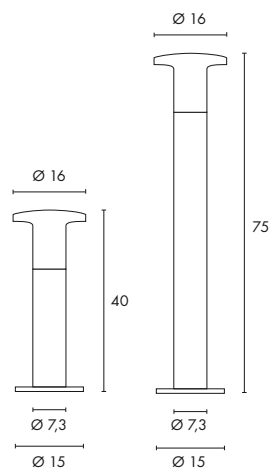
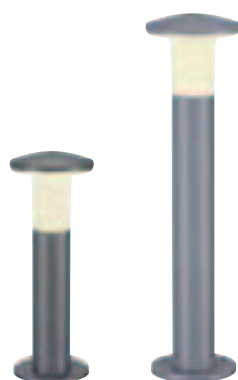

Socket/Bulb:
E27/EnergySaver (excl.)
up to max. Ø/L: 5,2/16 cm
24W max.

Material:
Aluminium
Light surface PC

Accessory/Included parts:
Screws (excl.)

Note:
The connection box (228730) is especially suitable for a safe connection in the lamp shaft, see below.

Versions:
Alpa Mushroom 40
silver grey
stone grey

Art. No.:
228932
228935

Alpa Mushroom 75
silver grey
stone grey

228942
228945

Recommended bulb:
23W, 2700K, 1350lm, EEK=A
508970



ALPA CONE 75 / ALPA CONE 100 Design by CDC/FGL

230~



IP55

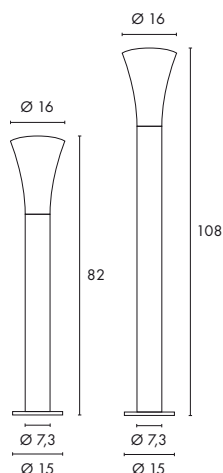

Socket/Bulb:
E27/EnergySaver (excl.)
up to max. Ø/L: 5,2/17,5 cm
24W max.

Material:
Aluminium
Light surface PC

Accessory/Included parts:
Screws (excl.)

Note:
The connection box (228730) is especially suitable for a safe connection in the lamp shaft, see below.

Versions:
Alpa Cone 75
silver grey
stone grey

Art. No.:
228912
228915

Alpa Cone 100
silver grey
stone grey

228922
228925

Recommended bulb:
23W, 2700K, 1350lm, EEK=A
508970



ACCESSORY for Alpa Cone and Alpa Mushroom

	<p>Earth spike Steel galvanized Ø/H: 14/37 cm Screws (incl.)</p>	<p>Art. No.: 228722</p>		<p>Connection box IP68 Plastic 3-pole Ø/L: 2,7/11,5 cm</p>	<p>Art. No.: 228730</p>
	<p>Concrete anchor set M6 Thread Stainless steel Product-L: 20 cm Cap nuts (incl.)</p>	<p>Art. No.: 228712</p>	<p>Specially for a safe connection in the lamp shaft. Also suitable for Alpa Mushroom 40 (228932/-5).</p>		
	<p>Hanger bolt, 3pce. set M6 Thread Stainless steel Ø/L: 0,6/8 cm Cap nuts, dowels, washers (incl.)</p>	<p>Art. No.: 228752</p>		<p>Connection box IP67 Plastic L/W/H: 25/4,5/6 cm</p>	<p>Art. No.: 229262</p>
			<p>Specially for a safe connection in the lamp shaft. Not suitable for Alpa Mushroom 40 (228932/-5).</p>		





ALPA II 75

230~



IP55



Socket/Bulb:
E27/EnergySaver (excl.)
up to max. Ø/L: 5,2/17,5 cm
24W max.

Versions:
silver grey
stone grey

Art. No.:
228862
228865



Material:
Aluminium
Light surface PC

Dimensions:
Head-Ø: 10 cm
Product-Ø/H: 7,3/75 cm
Base-Ø: 14,7 cm

Accessory/Included parts:
Grid (incl.)
Screws (excl.)

Recommended bulb:
23W, 2700K, 1350lm, EEK=A
508970



ALPA II 100

230~



IP55



Socket/Bulb:
E27/EnergySaver (excl.)
up to max. Ø/L: 5,2/17,5 cm
24W max.

Versions:
silver grey
stone grey

Art. No.:
228872
228875

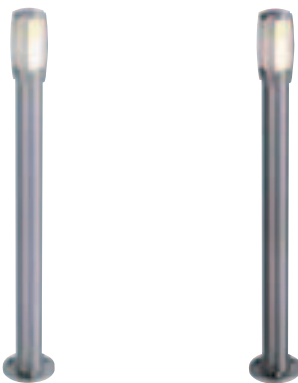

Material:
Aluminium
Light surface PC

Dimensions:
Head-Ø: 10 cm
Product-Ø/H: 7,3/100 cm
Base-Ø: 14,7 cm

Accessory/Included parts:
Grid (incl.)
Screws (excl.)

Recommended bulb:
23W, 2700K, 1350lm, EEK=A
508970



ACCESSORY for Alpa II



Earth spike
Steel galvanized
Ø/H: 14/37 cm
Screws (incl.)

Art. No.:
228722



Concrete anchor set
M6 Thread
Stainless steel
Product-L: 20 cm
Cap nuts (incl.)

Art. No.:
228712



Hanger bolt, 3pce. set
M6 Thread
Stainless steel
Ø/L: 0,6/8 cm
Cap nuts, dowels,
washers (incl.)

Art. No.:
228752



Connection box IP67
Plastic
L/W/H: 25/4,5/6 cm

Art. No.:
229262

Specially for a safe connection in the lamp shaft.



ALPA II WALL

230~



IP55

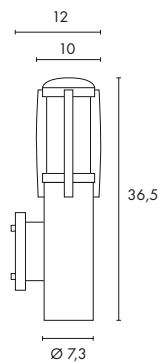

Socket/Bulb:
E27/EnergySaver (excl.)
up to max. Ø/L: 5,2/17,5 cm
24W max.

Material:
Aluminium
Light surface PC

Accessory/Included parts:
Grid (incl.)

Versions:
silver grey
stone grey

Art. No.:
228882
228885

Recommended bulb:
23W, 2700K, 1350lm, EEK=A
508970



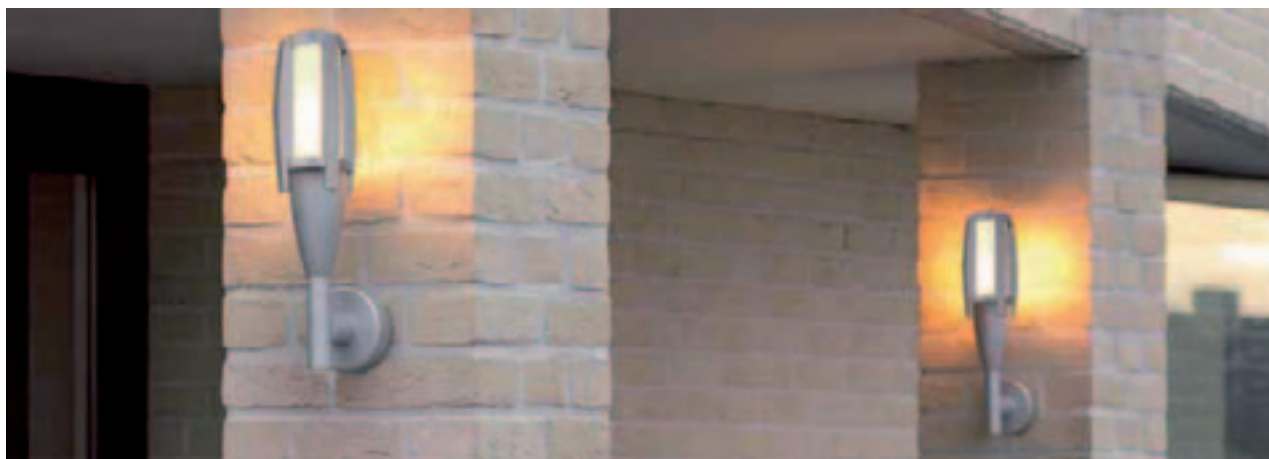

BELPA II WALL

230~



IP55

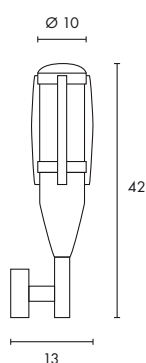

Socket/Bulb:
E27/EnergySaver (excl.)
up to max. Ø/L: 5,2/17,5 cm
24W max.

Material:
Aluminium
Light surface PC

Accessory/Included parts:
Grid (incl.)

Versions:
silver grey
stone grey

Art. No.:
228892
228895

Recommended bulb:
23W, 2700K, 1350lm, EEK=A
508970



BELPA II LAMP HEAD

230~



IP55

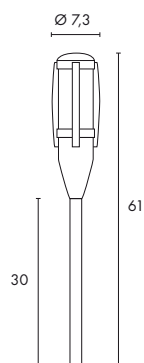

Socket/Bulb:
E27/EnergySaver (excl.)
up to max. Ø/L: 5,2/17,5 cm
24W max.

Material:
Aluminium
Light surface PC

Dimensions:
Supply line-L: 2 m

Accessory/Included parts:
Grid (incl.)

Versions:
silver grey

Art. No.:
228902

Recommended bulb:
23W, 2700K, 1350lm, EEK=A
508970



ACCESSORY for Belpa II Lamp head

	<p>Extension rod Aluminium Product-L: 30 cm</p> <p>2 pieces per lamp must be used.</p>	<p>Art. No.: 228682</p>	<p>Base Aluminium Ø/H: 14/9 cm Screws (excl.)</p> <p>Art. No.: 228702</p>
	<p>End piece/earth spike Aluminium Product-L: 30 cm</p>	<p>Art. No.: 228692</p>	<p>Earth spike Steel galvanized Ø/H: 14/37 cm Screws (incl.)</p> <p>Art. No.: 228722</p>
	<p>Concrete anchor set M6 Thread Stainless steel Product-L: 20 cm Cap nuts (incl.)</p>	<p>Art. No.: 228712</p>	<p>Hanger bolt, 3pce. set M6 Thread Stainless steel Ø/L: 0,6/8 cm Cap nuts, dowels, washers (incl.)</p> <p>Art. No.: 228752</p>





OVA WALL

230~



IP55



Socket/Bulb:
E27/EnergySaver (excl.)
up to max. Ø/L: 4,5/17 cm
15W max.

Material:
Aluminium
Light surface PC

Dimensions:
W/H/D: 6/44/7,6 cm
Canopy-L/W/D: 10,5/8/5 cm
Wall distance: 4,3 cm

Versions:
silver grey
stone grey

Art. No.:
228602
228605

Recommended bulb:
15W, 2700K, 800lm, EEK=A
508960



OVA TORCH

230~



IP55

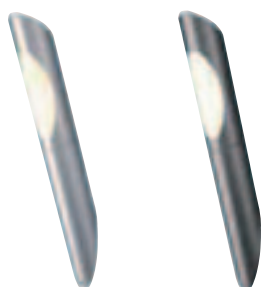

Socket/Bulb:
E27/EnergySaver (excl.)
up to max. Ø/L: 4,5/17 cm
15W max.

Material:
Aluminium
Light surface PC

Dimensions:
W/H/D: 6/50/7,6 cm
Wall distance: 11,5 cm

Accessory/Included parts:
Connection box (incl.)

Versions:
silver grey
stone grey

Art. No.:
228762
228765

Recommended bulb:
15W, 2700K, 800lm, EEK=A
508960



OVA 75

230~



IP55



Socket/Bulb:
E27/EnergySaver (excl.)
up to max. Ø/L: 4,5/17 cm
15W max.

Material:
Aluminium
Light surface PC

Dimensions:
W/H/D: 6/75/7,5 cm
Base-Ø: 14,7 cm

Accessory/Included parts:
Screws (excl.)

Versions:
silver grey
stone grey

Art. No.:
228612
228615

Recommended bulb:
15W, 2700K, 900lm, EEK=A
508415



OVA 100

230~



IP55



Socket/Bulb:
E27/EnergySaver (excl.)
up to max. Ø/L: 5,2/17,3 cm
24W max.

Material:
Aluminium
Light surface PC

Dimensions:
W/H/D: 6/100/7,5 cm
Base-Ø: 14,7 cm

Accessory/Included parts:
Screws (excl.)

Versions:
silver grey
stone grey

Art. No.:
228622
228625

Recommended bulb:
24W, 2500K, 1500lm, EEK=A
508417



ACCESSORY for Ova 75 / 100



Earth spike
Steel galvanized
Ø/H: 14/37 cm
Screws (incl.)

Art. No.:
228722



Concrete anchor set
M6 Thread
Stainless steel
Product-L: 20 cm
Cap nuts (incl.)

Art. No.:
228712



Hanger bolt, 3pce. set
M6 Thread
Stainless steel
Ø/L: 0,6/8 cm
Cap nuts, dowels,
washers (incl.)

Art. No.:
228752



Connection box IP67
Plastic
L/W/H: 25/4,5/6 cm

Art. No.:
229262

Specially for a safe connection in the lamp shaft.





TRUST WALL

230~



IP55

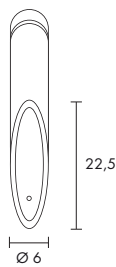

Socket/Bulb:
E27/EnergySaver (excl.)
up to max. Ø/L: 4,8/13,5 cm
11W max.

Material:
Stainless steel 304
Light surface PC

Dimensions:
Ø/H: 6/42 cm
Wall distance: 10 cm

Accessory/Included parts:
Grid (excl.)
Screws (incl.)

Versions:
stainless steel

Art. No.:
227942

Recommended bulb:
11W, 2700K, 580lm, EEK=A
508211



TRUST 30 / TRUST 60

230~



IP55

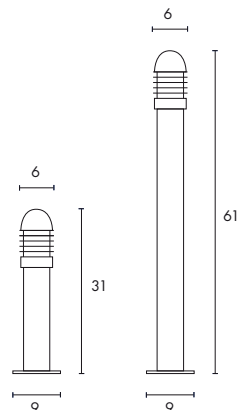

Socket/Bulb:
E27/EnergySaver (excl.)
up to max. Ø/L: 4,8/13,5 cm
11W max.

Material:
Stainless steel 304
Light surface PC

Accessory/Included parts:
Grid (excl.)

Versions:
stainless steel
Trust 30

Art. No.:
227932

Trust 60

227962

Recommended bulb:
11W, 2700K, 580lm, EEK=A
508211



ACCESSORY for Trust



Earth spike
Steel galvanized
Product-L: 50 cm
Screws (incl.)

Art. No.:
227922



Grid
Stainless steel 304
Ø/H: 8/10 cm

Art. No.:
227952



Connection box IP68
Plastic
3-pole
Ø/L: 2,7/11,5 cm
Specially for a safe connection in the lamp shaft.

Art. No.:
228730

BIG NAILS WALL LAMP Design by CDC

230~ IP44



Socket/Bulb:
E27/EnergySaver (excl.)
up to max. Ø/L: 4,5/17 cm
15W max.

Material:
Stainless steel 304

Dimensions:
W/H/D: 7/34,5/14,5 cm
Glass-Ø/H: 6/16 cm

Versions:
stainless steel

Art. No.:
229182

Recommended bulb:
15W, 2700K, 800lm, EEK=A
508960

BIG NAILS 50 / BIG NAILS 80 Design by CDC

230~ IP44



Socket/Bulb:
E27/EnergySaver (excl.)
up to max. Ø/L: 4,5/17 cm
15W max.

Material:
Stainless steel 304

Dimensions:
Ø/H: 6,5/51 cm (229162)
Ø/H: 6,5/81 cm (229172)
Base-L/W: 9/9 cm
Glass-Ø/H: 6/16 cm

Versions:
stainless steel
Big Nails 50

Art. No.:
229162

Big Nails 80

229172

Recommended bulb:
15W, 2700K, 800lm, EEK=A
508960

ACCESSORY for Big Nails 50 / 80

Earth spike
Steel galvanized
Product-L: 50 cm
Screws (incl.)

Art. No.:
227922



NAILS WALL LAMP

Design by CDC

230~



IP44

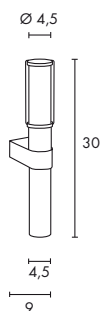

Socket/Bulb:
G9/G9 (excl.)
40W max.

Material:
Stainless steel 304

Accessory/Included parts:
Glass insert (incl.)

Versions:
stainless steel

Art. No.:
229132

Recommended bulb:
33W EnergySaver ≈ 40W
2700K, 460lm, EEK=C
519451



NAILS FLOOR LAMP

Design by CDC

230~



IP44

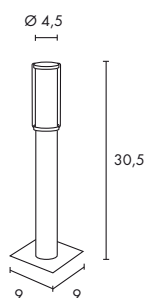

Socket/Bulb:
G9/G9 (excl.)
40W max.

Material:
Stainless steel 304

Accessory/Included parts:
Glass insert (incl.)

Versions:
stainless steel

Art. No.:
229142

Recommended bulb:
33W EnergySaver ≈ 40W
2700K, 460lm, EEK=C
519451



NAILS SPIKE

Design by CDC

230~



IP44

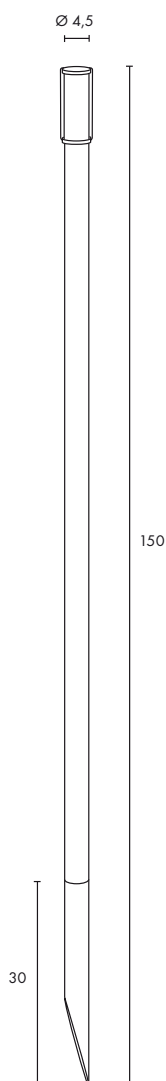

Socket/Bulb:
G9/G9 (excl.)
40W max.

Material:
Stainless steel 304

Dimensions:
Mains cable-L: 1,5 m

Accessory/Included parts:
Glass insert (incl.)
Mains plug (incl.)

Versions:
stainless steel

Art. No.:
229152

Recommended bulb:
33W EnergySaver ≈ 40W
2700K, 460lm, EEK=C
519451



The 9,5 cm high satined glass insert of the Nails lamps can be used with slanted or straight side showing upwards.



ACCESSORY for Nails floor lamp



Earth spike
Steel galvanized
Product-L: 50 cm
Screws (incl.)

Art. No.:
227922





CUBIC PATHLIGHT L-Type

230~



IP44

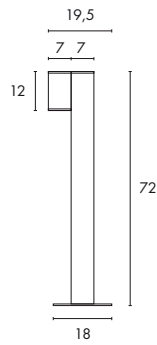
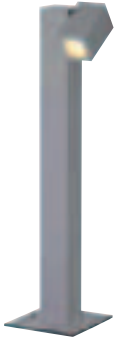

Socket/Bulb:
GU10/EnergySaver (excl.)
up to max. L: 8,5 cm
or GU10/GU10 (excl.)
25W max.

Material:
Aluminium

Versions:
silver grey

Art. No.:
232554

Recommended bulb:
11W EnergySaver,
2700K, 220lm
508920



Recommended bulb:
PHILIPS LEDspot 4W
36°, 3000K, 300cd, 165lm
560084



CUBIC PATHLIGHT T-Type

230~



IP44

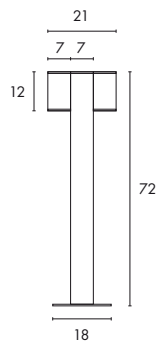
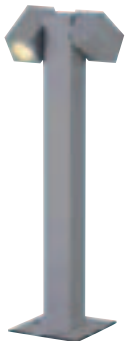

Socket/Bulb:
GU10/EnergySaver (excl.)
up to max. L: 8,5 cm
or GU10/GU10 (excl.)
2x 25W max.

Material:
Aluminium

Versions:
silver grey

Art. No.:
232564

Recommended bulb:
11W EnergySaver,
2700K, 220lm
508920



Recommended bulb:
PHILIPS LEDspot 4W
36°, 3000K, 300cd, 165lm
560084



ACCESSORY for Cubic Pathlight



Earth spike
Stainless steel 304
Product L: 50 cm
Screws (incl.)

Art. No.:
232221

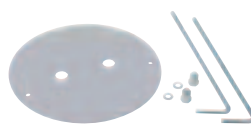

Concrete anchor set
Stainless steel 304
1 mounting plate,
2 anchor screws,
2 washers,
2 cap nuts (incl.)

Art. No.:
232220

SITRA 360 WL Design by CDC

230~ IP44



Socket/Bulb:
 GX53/GX53 EnergySaver (excl.)
 9W max.
 or LED GX53, 2,8W (excl.)
 or
 PowerLED GX53, 3x 1,4W (excl.)

Versions:
 stone grey
 anthracite

Art. No.:
 231514
 231515

Material:
 Aluminium/glass

Recommended bulb:
 9W, 2700K, 260lm
 508860



Dimensions:
 Ø/H/D: 10/11,6/17 cm

Recommended bulb:
 3x 1,4W PowerLED
 3250K, 200lm
 550092

SITRA 360 SL Design by CDC

230~ IP44



Socket/Bulb:
 GX53/GX53 EnergySaver (excl.)
 2x 9W max.
 or LED GX53, 2,8W (excl.)
 or
 PowerLED GX53, 3x 1,4W (excl.)

Versions:
 stone grey
 anthracite

Art. No.:
 231504
 231505

Material:
 Aluminium/glass

Recommended bulb:
 9W, 2700K, 260lm
 508860



Dimensions:
 W/H/D: 28/72/11,6 cm

Recommended bulb:
 3x 1,4W PowerLED
 3250K, 200lm
 550092

ACCESSORY for Sitra 360 SL

Earth spike
 Steel galvanized
 Product-L: 48 cm
 4 screws,
 4 nuts,
 4 washers (incl.)

Art. No.:
 230060



MYRA 2-PART LAMP HEAD

230~



340°



45°



IP44



Socket/Bulb:
GU10/ESL (excl.)
or
GU10/LED (excl.)

Material:
Aluminium

Dimensions:
Product-H: 30,5 cm
Head-Ø: 7 cm
Supply line-L: 2 m

Versions:
silver grey







Art. No.:
228792

Recommended bulb:

 LEDspot 4W
36°, 3000K, 300cd, 165lm
560084



ACCESSORY for Myra 2er Lamp head

	<p>Extension rod Aluminium Product-L: 30 cm</p> <p>2 pieces per lamp must be used.</p>	<p>Art. No.: 228682</p>	 <p>Base Aluminium Ø/H: 14/9 cm Screws (excl.)</p> <p>Art. No.: 228702</p>
	<p>End piece/earth spike Aluminium Product-L: 30 cm</p>	<p>Art. No.: 228692</p>	 <p>Earth spike Steel galvanized Ø/H: 14/37 cm Screws (incl.)</p> <p>Art. No.: 228722</p>
	<p>Concrete anchor set M6 Thread Stainless steel Product-L: 20 cm Cap nuts (incl.)</p>	<p>Art. No.: 228712</p>	 <p>Hanger bolt, 3pce. set M6 Thread Stainless steel Ø/L: 0,6/8 cm Cap nuts, dowels, washers (incl.)</p> <p>Art. No.: 228752</p>





MYRA WALL

230~ IP55



Socket/Bulb:
GU10/GU10 (excl.)
50W max.

Versions:
silver grey
anthracite

Art. No.:
228782
228785

Material:
Aluminium

Dimensions:
W/H/D: 8/10,5/14,5 cm
Head-Ø: 7 cm

Recommended bulb:
35W EnergySaver \approx 50W
20°, 2800K, 1200cd
575370



MYRA UP-DOWN

230~ IP55



Socket/Bulb:
GU10/GU10 (excl.)
2x 50W max.

Versions:
silver grey
anthracite

Art. No.:
228802
228805

Material:
Aluminium

Dimensions:
W/H/D: 8/16,5/14 cm
Head-Ø: 7 cm

Recommended bulb:
35W EnergySaver \approx 50W
20°, 2800K, 1200cd
575370



ROX LED UP-DOWN Design by CDC

230~ IP44

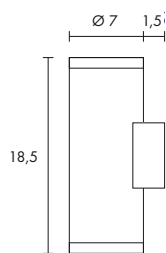

Bulb:
PowerLED (incl.)
2x 3W

Material:
Aluminium

Accessory/Included parts:
LED driver (incl.)

Versions:
alu brushed/varnished
LED white
LED warm white

Art. No.:
227231
227232

ASTINA OUT ESL

230~ IP44



Socket/Bulb:
GU10/EnergySaver (excl.)
or LED GU10, 4W (excl.)
up to max. L: 9 cm

Material:
Aluminium

Dimensions:
Ø/L: 6/23 cm
Canopy-Ø/D: 8/4 cm
Product-D: 10 cm

Versions:
white
silver grey
anthracite
alu brushed

Art. No.:
228771
228774
228775
228776

Recommended bulb:
11W EnergySaver,
2700K, 220lm
508920



Recommended bulb:
PHILIPS LEDspot 4W
36°, 3000K, 300cd, 165lm
560084





DROP 50



Socket/Bulb:
G5,3/MR16 (excl.)
50W max.

Versions:
silver grey

Art. No.:
227041

Material:
Aluminium

Dimensions:
W/H/D: 10/14/14 cm
Lamp head-Ø/L: 5,7/9 cm

Recommended bulb:
50W, 40°, 2700K, 1500cd
536540



Accessory/Included parts:
Electronic transformer (incl.)

Recommended bulb:
 PowerLED 4W
36°, 3000K, 500cd
560044



DROP 100



Socket/Bulb:
G5,3/MR16 (excl.)
2x 50W max.

Versions:
silver grey

Art. No.:
227042

Material:
Aluminium

Dimensions:
W/H/D: 10/18/14 cm
Lamp head-Ø/L: 5,7/9 cm

Recommended bulb:
50W, 40°, 2700K, 1500cd
536540



Accessory/Included parts:
Electronic transformer (incl.)

Recommended bulb:
 PowerLED 4W
36°, 3000K, 500cd
560044





MICRO FLAT Design by CDC/FGL

230~



IP44

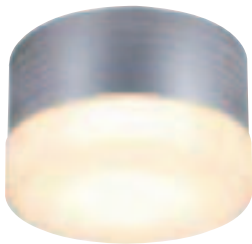

Socket/Bulb:
GX53/EnergySaver (excl.)
9W max.

Material:
Aluminium/glass

Dimensions:
Ø/H: 13/8 cm

Versions:
Glass satined
silver grey

Art. No.:
229912

Recommended bulb:
9W, 2700K, 260lm
508860



SITRA WALL Design by CDC

230~



IP44



Socket/Bulb:
GX53/GX53 EnergySaver (excl.)
9W max.
or LED GX53, 2,8W (excl.)
or
PowerLED GX53, 3x 1,4W (excl.)

Material:
Aluminium/glass

Dimensions:
W/H/D: 10/10/15,5 cm
Canopy-Ø/D: 10/4 cm

Versions:
stone grey
anthracite

Art. No.:
230354
230355

Recommended bulb:
9W, 2700K, 260lm
508860



Recommended bulb:
3x 1,4W PowerLED
3250K, 200lm
550092

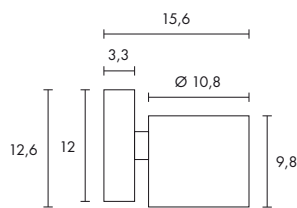
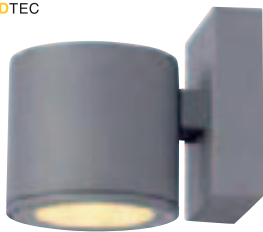

SITRA 6x 1W LED

Bulb:
PowerLED (incl.)
6x 1W

Material:
Aluminium/glass

Dimensions:
Canopy-W/H/D: 9/12/3,3 cm

Accessory/Included parts:
LED driver (incl.)

Versions:
silver grey
LED 3000K

Art. No.:
230332

SITRA WALL UP-DOWN Design by CDC

Socket/Bulb:
GX53/GX53 EnergySaver (excl.)
2x 9W max.
or 2x LED GX53, 2,8W (excl.)
or
2x PowerLED GX53, 3x 1,4W (excl.)

Material:
Aluminium/glass

Dimensions:
W/H/D: 10/12,5/15,5 cm
Canopy-Ø/D: 10/4 cm

Versions:
stone grey
anthracite

Art. No.:
230364
230365

Recommended bulb:
9W, 2700K, 260lm
508860



Recommended bulb:
3x 1,4W PowerLED
3250K, 200lm
550092





SITRA SL

230~



IP44

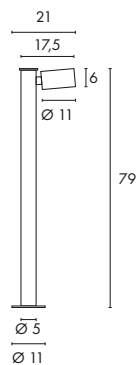
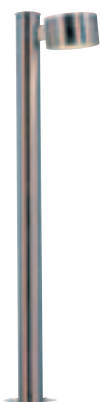

Socket/Bulb:
GX53/GX53 EnergySaver (excl.)
9W max.

Material:
Stainless steel 304

Dimensions:
L/W/H: 21/11/79 cm

Versions:
stainless steel brushed

Art. No.:
230071

Recommended bulb:
9W, 2700K, 260lm
508860



ACCESSORY for Sitra SL



Earth spike
Steel galvanized
Product-L: 48 cm
4 screws,
4 nuts,
4 washers (incl.)

Art. No.:
230060

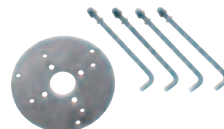

Concrete anchor set
Stainless steel
1 mounting plate,
4 concrete anchors,
4 washers,
4 cap nuts (incl.)

Art. No.:
230061

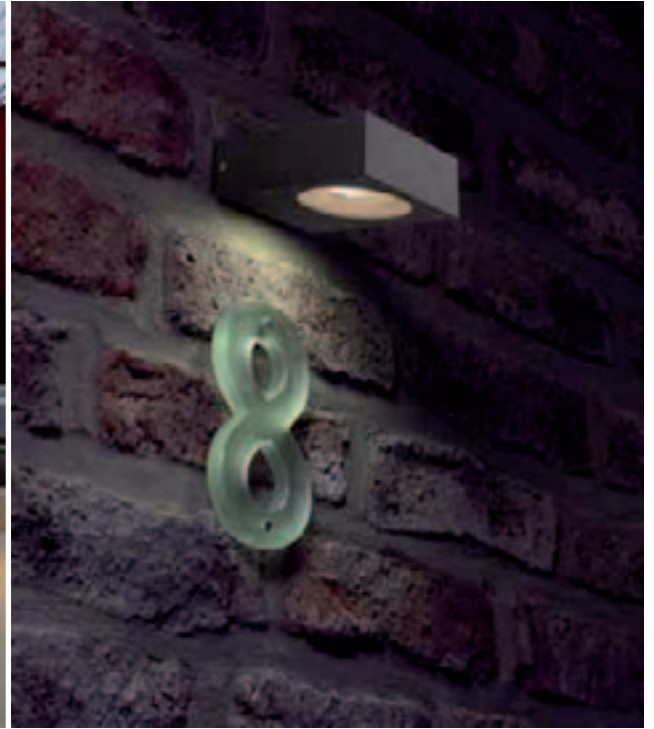
QUADRASYL WL 15

230~



IP44



Socket/Bulb:
GX53/GX53 EnergySaver (excl.)
11W max.

Versions:
silver grey
anthracite

Art. No.:
232284
232285

Material:
Aluminium

Dimensions:
L/W/H: 15/12/5,5 cm

Recommended bulb:
9W, 2700K, 260lm
508860

QUADRASYL SL 75

230~



IP44

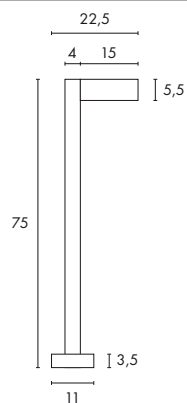

Socket/Bulb:
GX53/GX53 EnergySaver (excl.)
11W max.

Versions:
silver grey
anthracite

Art. No.:
232294
232295

Material:
Aluminium

Accessory/Included parts:
Concrete anchor set (incl.)

Recommended bulb:
9W, 2700K, 260lm
508860

ACCESSORY for Quadrasyl SL 75

Connection box IP68
Plastic
3-pole
Ø/L: 2,7/11,5 cm

Art. No.:
228730

Specially for a safe connection in the lamp shaft.

QUADRASYL 44 WALL Design by CDC

230~



0,45

IP44



Socket/Bulb:
GX53/GX53 EnergySaver (excl.)
9W max.

Versions:
Front stainless steel
silver grey

Art. No.:
111492

Material:
Aluminium
Front stainless steel 316

Dimensions:
W/H/D: 11,4,5/11 cm

Recommended bulb:
9W, 2700K, 260lm
508860

QUADRASYL 44 WITH BRACKET Design by CDC

230~



0,8

IP44



Socket/Bulb:
GX53/GX53 EnergySaver (excl.)
9W max.

Versions:
Front stainless steel
silver grey

Art. No.:
111522

Material:
Aluminium
Front stainless steel 316

Dimensions:
W/H/D: 13,5/13,5/11 cm
Mains cable-L: 1,5 m

Accessory/Included parts:
Protective contact plug (incl.)

Recommended bulb:
9W, 2700K, 260lm
508860

QUADRASYL 44D Design by CDC

230~



0,45

IP44



Socket/Bulb:
GX53/GX53 EnergySaver (excl.)
9W max.

Versions:
Front stainless steel
silver grey

Art. No.:
111482

Material:
Aluminium
Front stainless steel 316

Dimensions:
W/H/D: 11/11/4,5 cm

Recommended bulb:
9W, 2700K, 260lm
508860

QUADRASYL D Design by CDC

230~



0,25

IP23



Socket/Bulb:
GX53/GX53 EnergySaver (excl.)
9W max.

Versions:
Front stainless steel
silver grey

Art. No.:
111131

Material:
Aluminium
Front stainless steel 316

Dimensions:
W/H/D: 10,4/2,9/10,4 cm

Note:
In case of ceiling installation, the
lamp achieves protection class
IP23.

Recommended bulb:
9W, 2700K, 260lm
508860





SITRA CUBE

230~   1,14 IP44 



Socket/Bulb:
GX53/GX53 EnergySaver (excl.)
2x 9W max.

Material:
Aluminium

Versions:
white
anthracite
rust-coloured

Art. No.:
232531
232535
232537

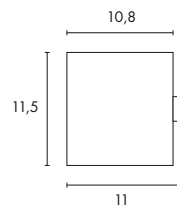

Recommended bulb:
9W, 2700K, 260lm
508860





BIG THEO CEILING OUT Design by CDC

230~   IP44 

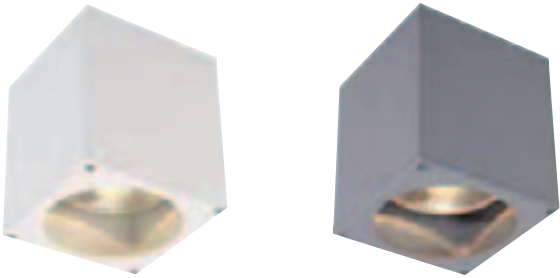

Socket/Bulb:
GU10/ES111 (excl.)
75W max.

Material:
Aluminium/glass

Dimensions:
L/W/H: 13/13/15 cm

Versions:
white
silver grey

Art. No.:
229551
229554

Recommended bulb:
75W, 24°, 2800K, 3500cd
575540



BIG THEO WALL OUT Design by CDC

230~   IP44 

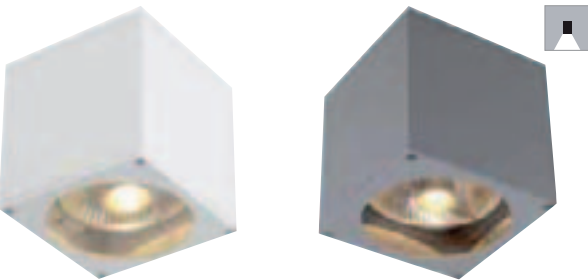

Socket/Bulb:
GU10/ES111 (excl.)
75W max.

Material:
Aluminium/glass

Dimensions:
W/H/D: 13/13,5/13 cm

Versions:
white
silver grey

Art. No.:
229561
229564

Recommended bulb:
75W, 24°, 2800K, 3500cd
575540



BIG THEO UP-DOWN OUT Design by CDC

230~   IP44 

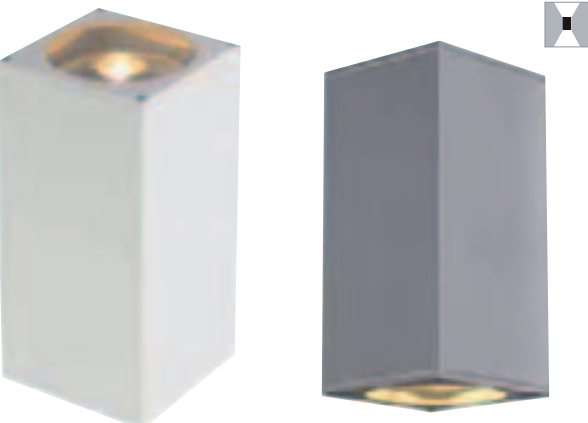

Socket/Bulb:
GU10/ES111 (excl.)
2x 75W max.

Material:
Aluminium/glass

Dimensions:
W/H/D: 13/27,5/13 cm

Versions:
white
silver grey

Art. No.:
229571
229574

Recommended bulb:
75W, 24°, 2800K, 3500cd
575540



BIG THEO BEAM Design by CDC

230~ IP44

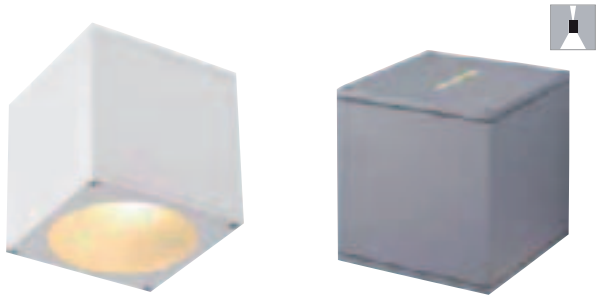

Socket/Bulb:
G9/G9 (excl.)
60W max.
or
G9/EnergySaver (excl.)
9W max.

Material:
Aluminium/glass

Dimensions:
W/H/D: 13/13,5/13 cm

Versions:
Glass satined
white
silver grey

Art. No.:
229601
229604

Recommended bulb:
48W, EnergySaver \approx 60W
2800K, 740lm, EEK=C
519452



BIG THEO CEILING OUT GX53 Design by CDC

230~ IP44

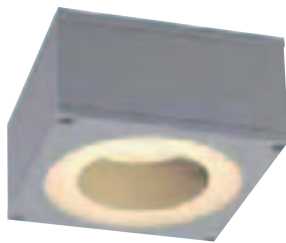

Socket/Bulb:
GX53/GX53 EnergySaver (excl.)
up to max. L: 4 cm
11W max.
or LED GX53, 5W max. (excl.)

Material:
Aluminium/glass

Dimensions:
W/H/D: 13/7/13 cm

Versions:
Glass partial satined
white
silver grey

Art. No.:
229981
229984

Recommended bulb:
9W, 2700K, 260lm
508860



BIG THEO WALL OUT GX53 Design by CDC

230~ IP44

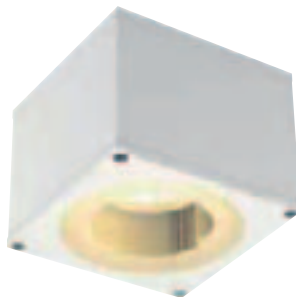

Socket/Bulb:
GX53/GX53 EnergySaver (excl.)
11W max.
or LED GX53, 5W max. (excl.)

Material:
Aluminium/glass

Dimensions:
W/H/D: 13/10,2/13,5 cm

Versions:
Glass partial satined
white
silver grey

Art. No.:
229991
229994

Recommended bulb:
9W, 2700K, 260lm
508860



BIG THEO UP-DOWN OUT GX53 Design by CDC

230~ IP44

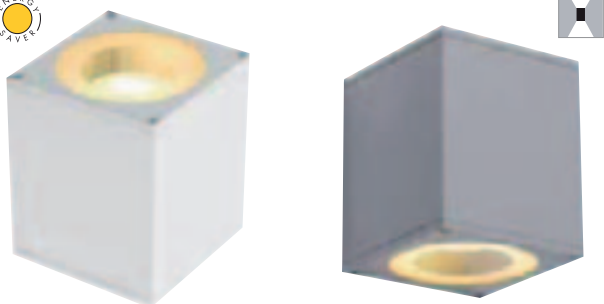

Socket/Bulb:
GX53/GX53 EnergySaver (excl.)
2x 11W max.
or
2x LED GX53, 2,8W (excl.)
2x PowerLED GX53, 3x 1,4W (excl.)

Material:
Aluminium/glass

Dimensions:
W/H/D: 13/16/13,5 cm

Versions:
Glass partial satined
white
silver grey

Art. No.:
229541
229544

Recommended bulb:
9W, 2700K, 260lm
508860



Recommended bulb:
3x 1,4W PowerLED, warm white
3250K, 170lm
550092







THEO CEILING OUT Design by CDC

230~   IP23 



Socket/Bulb:
GU10/GU10 (excl.)
35W max.

Versions:
white
silver grey

Art. No.:
229581
229584

Material:
Aluminium/glass

Dimensions:
W/H/D: 7/13,8/7 cm

Recommended bulb:
35W EnergySaver \neq 50W
20°, 2800K, 1200cd
575370



Recommended bulb:
 LEDspot 4W
36°, 3000K, 300cd, 165lm
560084



THEO UP-DOWN OUT Design by CDC

230~   IP44 



Socket/Bulb:
GU10/GU10 (excl.)
2x 35W max.

Versions:
white
silver grey
alu brushed

Art. No.:
229531
229532
229536

Material:
Aluminium/glass

Dimensions:
W/H/D: 7/22,5/7,5 cm

Recommended bulb:
35W EnergySaver \neq 50W
20°, 2800K, 1200cd
575370



Recommended bulb:
 LEDspot 4W
36°, 3000K, 300cd, 165lm
560084





WALLYX GU10

DESIGN BY CDC/FGL



silver grey

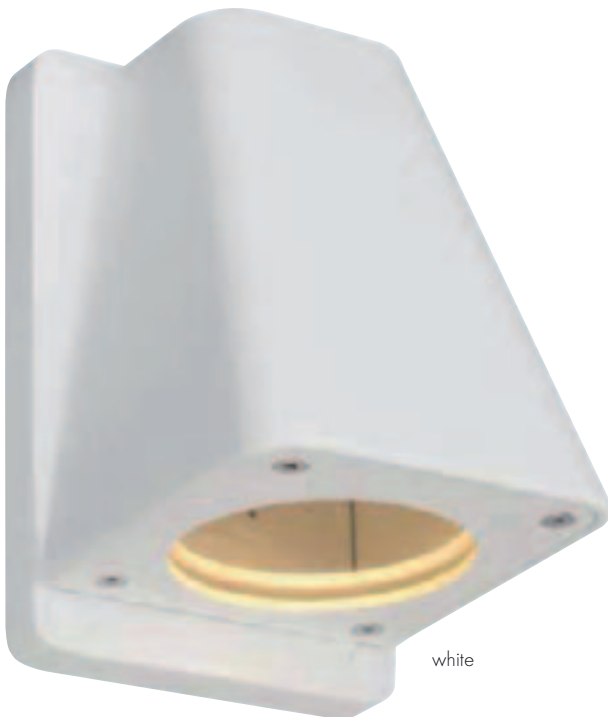

white



anthracite



antique bronze

WALLYX GU10 Design by CDC/FGL



230~



IP44



Socket/Bulb:
GU10/GU10 (excl.)
50W max.
or GU10 EnergySaver (excl.)
or GU10 PowerLED (excl.)
up to max. length: 7,6 cm

Material:
Aluminium

Dimensions:
W/H/D: 10/15,3/11,7 cm

Versions:	Art. No.:
white	227191
silver grey	227194
anthracite	227195
antique bronze	227198

Recommended bulb:
35W EnergySaver ≈ 50W
20°, 2800K, 1200cd
575370



Recommended bulb:
PHILIPS LEDspot 4W
36°, 3000K, 300cd, 165lm
560084





PEMA® SQUARE

230~ IP44

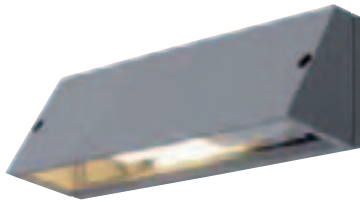

Socket/Bulb:
E27/ELD EnergySaver (excl.)
up to max. Ø/L: 4,5/21 cm
15W max.

Material:
Aluminium

Dimensions:
W/H/D: 28/10/9 cm

Note:
Protection class IP44 only with light
emission downwards.

Versions:
black
white
silver grey

Art. No.:
230030
230031
230034

Recommended bulb:
15W, 2700K, 800lm, EEK=A
508415



PEMA®

230~ IP44



Socket/Bulb:
G24d-2/TC-D EnergySaver (excl.)
18W

Material:
Aluminium

Dimensions:
W/H/D: 26/13/9 cm

Accessory/Included parts:
Low-loss ballast (incl.)

Note:
Protection class IP44 only with light
emission downwards.

Versions:
black
silver grey

Art. No.:
229890
229894

Recommended bulb:
18W, 2700K, 1200lm, EEK=B
508218





NOVA WALL OUT

230~



IP44



Socket/Bulb:
R7s/R7s, 78 mm (excl.)
100W max.

Material:
Aluminium

Dimensions:
W/H/D: 18/9/9,5 cm

Note:
Protection class IP44 only with light
emission downwards.

Versions:
silver grey

Art. No.:
227032

Recommended bulb:
100W EnergySaver \approx 150W
2700K, 1900lm, EEK=C
519215





anthracite

rust-coloured

BOX-L E27

230~ IP44

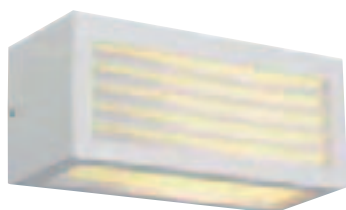

Socket/Bulb:
E27/EnergySaver (excl.)
up to max. L: 17,5 cm
18W max.

Material:
Aluminium/acrylic

Dimensions:
W/H/D: 25/11/11 cm

Versions:
white
anthracite
rust-coloured

Art. No.:
232491
232495
232497

Recommended bulb:
15W, 2700K, 800lm, EEK=A
508960



THEOS 101 E27 Design by CDC

230~ IP44



Socket/Bulb:
E27/EnergySaver (excl.)
up to max. L: 13 cm
24W max.

Material:
Aluminium/glass

Dimensions:
W/H/D: 22,5/12,5/9 cm

Versions:
Glass satined
white
alu brushed
bronze

Art. No.:
229611
229616
229618

Recommended bulb:
15W, 2700K, 850lm, EEK=A
508740



THEOS 102 E27 Design by CDC

230~ IP44

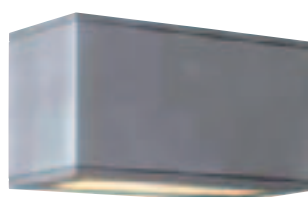

Socket/Bulb:
E27/EnergySaver (excl.)
up to max. L: 13 cm
24W max.

Material:
Aluminium/glass

Dimensions:
W/H/D: 22,5/12,5/9 cm

Versions:
Glass satined
white
alu brushed
bronze

Art. No.:
229621
229626
229628

Recommended bulb:
15W, 2700K, 850lm, EEK=A
508740







THEOS 103 TC-DE Design by CDC

230~



IP44



Socket/Bulb:
G24q-3/TC-DE EnergySaver (excl.)
26W

Versions:
silver grey
anthracite

Art. No.:
230494
230495

Material:
Aluminium

Dimensions:
W/H/D: 23,19,5/11,3 cm

Recommended bulb:
26W, 3000K, 1800lm, EEK=B
508222



Accessory/Included parts:
Electronic ballast (incl.)

THEOS CL 104 PL

230~



IP44

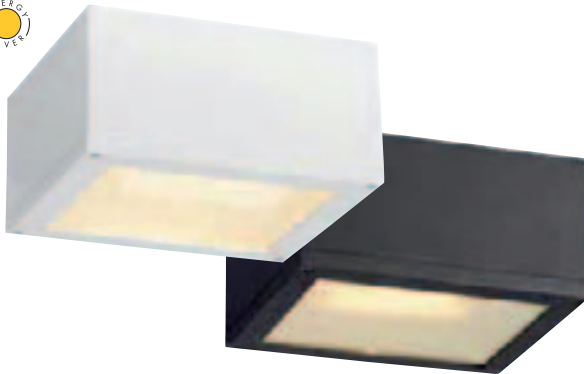

Socket/Bulb:
G24q-3/TC-DE EnergySaver (excl.)
26W

Versions:
white
anthracite

Art. No.:
232541
232545

Material:
Aluminium/glass

Dimensions:
W/H/D: 23,5/11,3/19,5 cm

Recommended bulb:
26W, 3000K, 1800lm, EEK=B
508222



Accessory/Included parts:
Electronic ballast (incl.)

LED DOWNUNDER ROUND

230~
mA
350



IP44

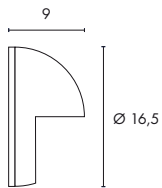
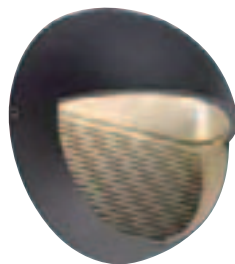

Bulb:
PowerLED (incl.)
3x 1W

Versions:
anthracite
LED 3000K

Art. No.:
230862

Material:
Aluminium/acrylic

Accessory/Included parts:
LED driver (incl.)

Note:
Protection class IP44 only with light
emission downwards.

LED DOWNUNDER SQUARE

230~
mA
350



IP44

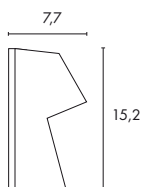
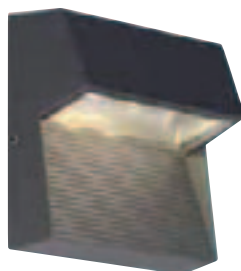

Bulb:
PowerLED (incl.)
3x 1W

Versions:
anthracite
LED 3000K

Art. No.:
230872

Material:
Aluminium/acrylic

Dimensions:
W/H/D: 15,3/15,2/7,7 cm

Accessory/Included parts:
LED driver (incl.)

Note:
Protection class IP44 only with light
emission downwards.

DELSIN LED

230~ (LED) 36 pce. 0,32 IP44



Bulb:
LED (incl.)
4W total

Material:
Aluminium/glass

Dimensions:
Ø/D: 14,5/2 cm

Versions:
stone grey/glass satined
LED warm white
LED white

Art. No.:
230822
230824

WL 172 GX53

230~ 0,51 IP44



Socket/Bulb:
GX53/EnergySaver (excl.)
11W max.

Material:
Aluminium/PC

Dimensions:
W/H/D: 14,5/14,5/6 cm

Note:
Protection class IP44 only with light
emission downwards.

Versions:
silver grey
anthracite

Art. No.:
229904
229905

Recommended bulb:
9W, 2700K, 260lm
508860



MINI EYE LED

12~ (LED) 12 pce. 0,4 IP20/IP44



Bulb:
LED (incl.)
1,85W total

Material:
Stainless steel 304

Dimensions:
Ø/D: 10,5/5 cm

Accessory/Included parts:
Conventional transformer (excl.)

Note:
Protection class IP44 only with light
emission downwards.
Operate only with conventional
transformer!

Versions:
stainless steel brushed
LED warm white

Art. No.:
230852

PEMA LED WALL LAMP

230~ (LED) 1 pce. 0,3 IP44

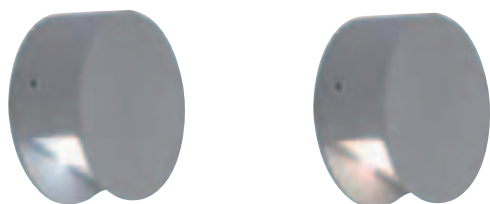

Bulb:
PowerLED (incl.)
1x 3,3W

Material:
Aluminium

Dimensions:
Ø/D: 9/4,4 cm

Note:
Protection class IP44 only with light
emission downwards.

Versions:
silver grey
LED 5300K
LED 3200K

Art. No.:
231011
231012





DACU UP-DOWN

230~



0,5

IP44

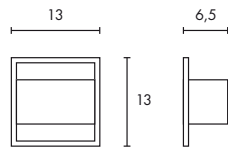

Socket/Bulb:
G9/G9 (excl.)
40W max.

Material:
Aluminium

Versions:
silver grey
alu brushed

Art. No.:
227132
227136

Recommended bulb:
33W EnergySaver \approx 40W
2700K, 460lm, EEK=C
519451



DACU UP-DOWN LED

230~
mA
350LED
2 pce.

120°



0,55

IP44



LED
LEDTEC

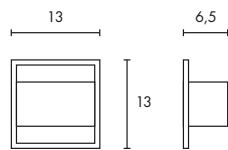

Bulb:
PowerLED (incl.)
2x 1W

Material:
Aluminium

Accessory/Included parts:
LED driver (incl.)

Versions:
silver grey
LED 2700K

Art. No.:
227262

DACU UP-DOWN LED BEAM

230~
mA
350LED
2 pce.Beam
8°Flood
120°

0,55

IP44



LED
LEDTEC

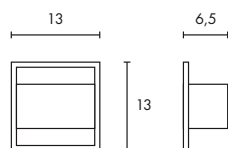

Bulb:
PowerLED (incl.)
2x 1W

Material:
Aluminium

Accessory/Included parts:
LED driver (incl.)

Versions:
silver grey
LED 2700K

Art. No.:
227252



DACU LED Design by CDC



Bulb:
PowerLED (incl.)
2x 1W

Material:
Aluminium

Dimensions:
W/H/D: 13/13/6,2 cm

Accessory/Included parts:
LED driver (incl.)

Versions:
silver grey
LED 6000K
LED 3000K

Art. No.:
152041
152042

DACU G9 Design by CDC



Socket/Bulb:
G9/G9 (excl.)
40W max.

Material:
Aluminium

Dimensions:
W/H/D: 13/13/6,2 cm

Versions:
silver grey
alu brushed

Art. No.:
227102
227106

Recommended bulb:
33W EnergySaver \approx 40W
2700K, 460lm, EEK=C
519451



QUAD 1

230~
700LED
1 pce.

90°



1a 40°

0,25

IP44

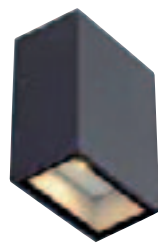

Bulb:
PowerLED (incl.)
3W

Material:
Aluminium/glass

Dimensions:
W/H/D: 6,4/8,7/4,2 cm

Accessory/Included parts:
LED driver (incl.)

Versions:
white, LED 3000K
anthracite, LED 3000K

Art. No.:
232461
232465

QUAD 2

230~
700LED
2 pce.

60°



1a 40°

0,6

IP44



Bulb:
PowerLED (incl.)
2x 3W

Material:
Aluminium/glass

Dimensions:
W/H/D: 4/12,4/9,5 cm

Accessory/Included parts:
LED driver (incl.)

Versions:
white, LED 3000K
anthracite, LED 3000K

Art. No.:
232471
232475

DELWA BLUE

230~
350LED
2 pce.

90°



0,45

IP44

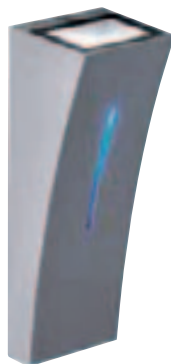
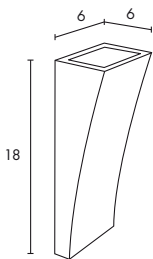

Bulb:
PowerLED (incl.)
LED white 5W
LED blue 1W

Material:
Aluminium/glass

Accessory/Included parts:
LED driver (incl.)

Note:
With blue deco light.

Versions:
silver grey
LED 6000K/blue

Art. No.:
230767

DELWA

230~

LED
1 pce.

90°



0,4

IP44

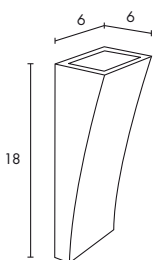

Bulb:
PowerLED (incl.)
4W

Material:
Aluminium/glass

Versions:
white
LED 6000K
LED 3000K

Art. No.:
231901
231902

silver grey
LED 6000K
LED 3000K

231911
231912



DELWA WIDE Design by CDC

230~
mA
350

LED
2 pce.



0,8

IP44



LED
LEDTEC



Bulb:
PlanarLED (incl.)
2x 3,5W

Versions:
white, LED 3000K
silver grey, LED 3000K

Art. No.:
230791
230794

Material:
Aluminium/glass

Accessory/Included parts:
LED driver (incl.)

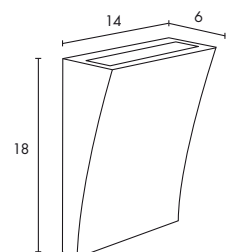
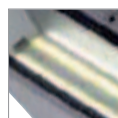
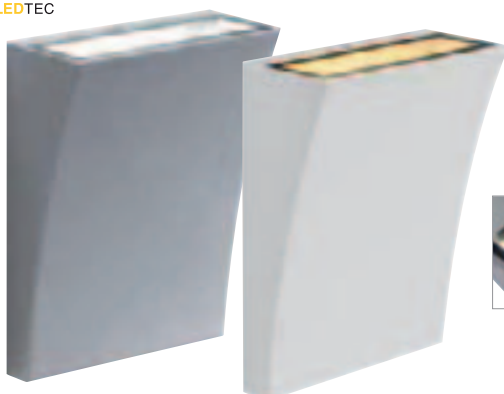



TENDA LED

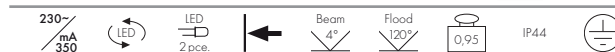

Bulb:

LED (incl.)
2x 4,2W

Material:

Aluminium/glass

Dimensions:

W/H/D: 13/13/13 cm

Accessory/Included parts:

LED driver (incl.)

Versions:

alu brushed
LED/Beam 6500K
LED/Beam 3000K
LED 6500K/Beam blue

Art. No.:

229641
229642
229647

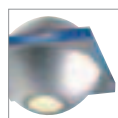

UFO BEAM Design by CDC



Socket/Bulb:

G9/G9 (excl.)
40W max.

Material:

Aluminium
Lens: Glass
Light surface: PC

Dimensions:

W/H/D: 10,5/13/16,4 cm
Canopy-L/W/H: 7/3,5/5,5 cm

Versions:

silver grey
PC white
PC blue

Art. No.:

151751
151757

Recommended bulb:

33W EnergySaver \approx 40W
2700K, 460lm, EEK=C
519451





DELWA CURVE











Bulb:
PowerLED (incl.)
2x 4x1W

Versions:
silver grey
LED 4000K

Art. No.:
227290

Material:
Aluminium

Dimensions:
W/H/D: 7,7/16/8,5 cm

Accessory/Included parts:
LED driver (incl.)





GLOO Outdoor Design by CDC

230~



IP44

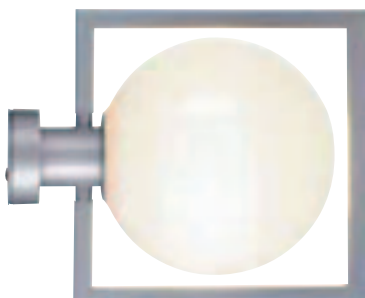

Socket/Bulb:
E27/EnergySaver (excl.)
up to max. Ø/L: 4,8/13,5 cm
11W max.

Material:
Aluminium/opaline glass
Frame protective galvanized,
varnished

Dimensions:
L/W: 30/24,5 cm
Head-Ø: 19 cm
Canopy-Ø/H: 8/2,5 cm

Versions:
silver grey

Art. No.:
229502

Recommended bulb:
11W, 2700K, 530lm, EEK=A
508950





SQUARE TURN G9 Design by CDC

230~

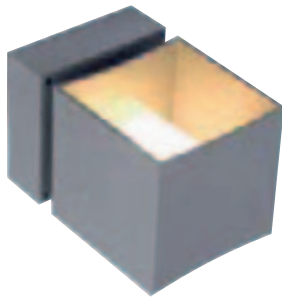

Socket/Bulb:
G9/G9 (excl.)
42W max.
or
G9/EnergySaver (excl.)
up to max. Ø/L: 3,5/8 cm

Versions:
silver grey

Art. No.:
230674

Material:
Aluminium/glass

Recommended bulb:
33W EnergySaver ≈ 40W
2700K, 460lm, EEK=C
519451



Dimensions:
L/W/H: 17,5/12/12 cm

SQUARE TURN HIT-TC Design by CDC

230~



HiEFFICIENT
PROFIlight.

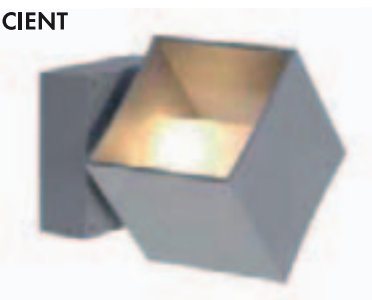

Socket/Bulb:
GU6,5/CDM-TC (excl.)
20W

Versions:
silver grey

Art. No.:
230684

Material:
Aluminium/glass

Recommended bulb:
20W, 3000K, 1615lm
507020



Dimensions:
L/W/H: 17,5/12/12 cm

Accessory/Included parts:
Electronic ballast (incl.)

MERIDIAN 3

230~



IP54



Socket/Bulb:
E27/EnergySaver (excl.)
up to max. length: 23 cm
25W max.

Material:
Aluminium
Light surface PC

Dimensions:
W/H/D: 13,5/37,5/14 cm

Versions:
white
silver grey
anthracite

Art. No.:
230641
230644
230645

Recommended bulb:

 Master Stairway ELT 15W
2700K, 850lm, Ra82, EEK=A
508600



MERIDIAN 2

230~



IP54



Socket/Bulb:
E27/EnergySaver (excl.)
up to max. Ø/L: 7/17,5 cm
25W max.

Material:
Aluminium
Light surface PC

Dimensions:
W/H/D: 14/38/14,5 cm

Versions:
silver grey
anthracite

Art. No.:
230444
230445

Recommended bulb:

23W, 2700K, 1350lm, EEK=A
508970



MERIDIAN BOX Design by CDC

230~



IP54



Socket/Bulb:
E27/EnergySaver (excl.)
up to max. Ø/L: 7/17,5 cm
25W max.

Material:
Aluminium
Light surface PC

Dimensions:
W/H/D: 13/37/14 cm

Versions:
silver grey
anthracite

Art. No.:
230044
230045

Recommended bulb:

15W, 2700K, 800lm, EEK=A
508960



KERAS ELT Design by CDC

230~



IP54



Socket/Bulb:
E27/EnergySaver (excl.)
up to max. Ø/L: 7/17,5 cm
25W max.

Material:
Aluminium
Light surface PC

Dimensions:
W/H/D: 13,5/29,5/12,8 cm

Versions:
silver grey
anthracite

Art. No.:
227174
227176

Recommended bulb:

23W, 2700K, 1350lm, EEK=A
508970



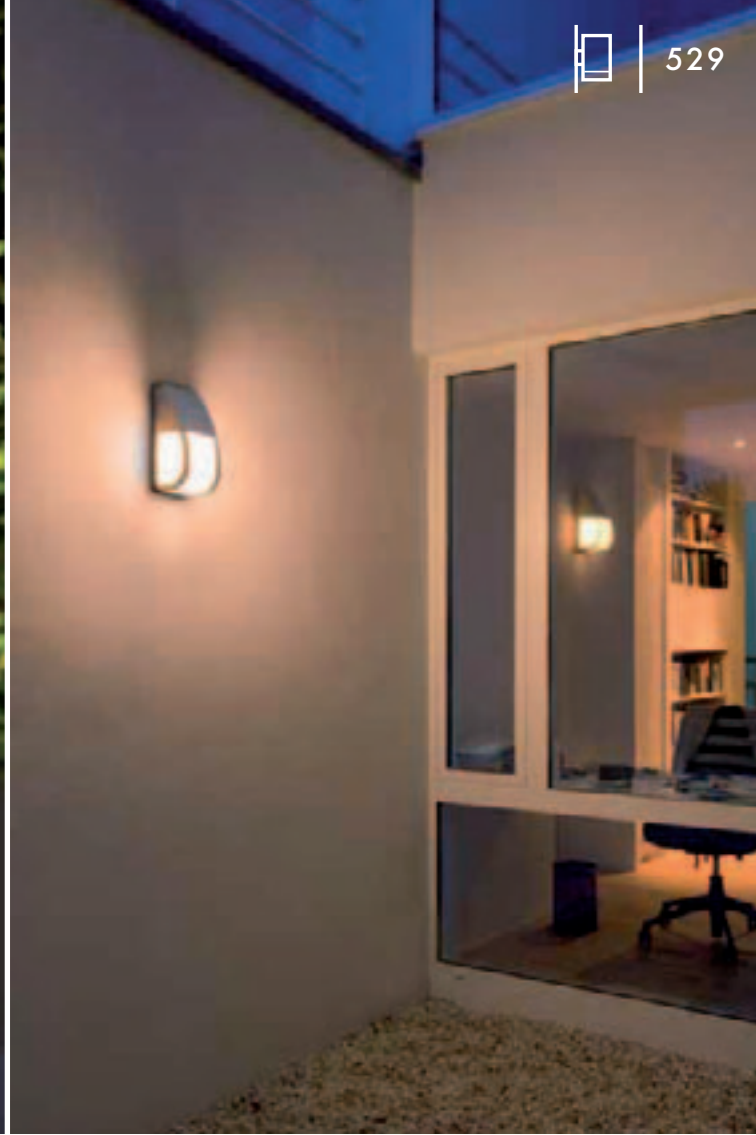



BULAN GRID

230- 1,3 IP44



Socket/Bulb:
E27/AGL (excl.)
2x 25W max.
or
E27/EnergySaver (excl.)
up to max. Ø/L: 5,2/17,3 cm

Material:
Aluminium/PC

Dimensions:
Ø/D: 27,5/8,5 cm

Versions:
white
silver grey
anthracite
rust-coloured

Art. No.:
229081
229084
229085
229087

Recommended bulb:
21W, 2500K, 1230lm, EEK=A
508416



BULAN

230- 1,7 IP44

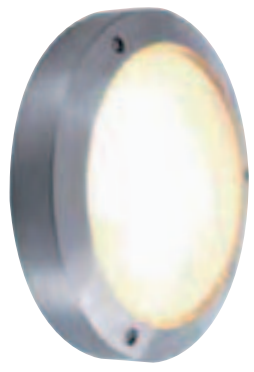

Socket/Bulb:
E14/EnergySaver (excl.)
up to max. Ø/L: 4,8/13 cm
11W max.

Material:
Aluminium/glass

Dimensions:
Ø/D: 27,5/7 cm

Versions:
Glass satined
white
silver grey

Art. No.:
229071
229072

metal brushed

229078

Recommended bulb:
11W, 2700K, 530lm, EEK=A
508810



DRAGAN

230- Ballast EEI=B2 4,0 IP44



Socket/Bulb:
G24d-3/TC-D EnergySaver (excl.)
2x 26W

Material:
Aluminium/PC

Dimensions:
Ø/D: 35/10,5 cm

Accessory/Included parts:
Low-loss ballast (incl.)

Versions:
silver grey
anthracite

Art. No.:
230404
230405

Recommended bulb:
26W, 2700K, 1800lm, EEK=B
508226



DRAGAN GRID

230- Ballast EEI=B2 3,5 IP44



Socket/Bulb:
G24d-3/TC-D EnergySaver (excl.)
2x 26W

Material:
Aluminium/PC

Dimensions:
Ø/D: 37,5/11,5 cm

Accessory/Included parts:
Ballast (incl.)

Versions:
white
silver grey
anthracite

Art. No.:
232501
232504
232505

Recommended bulb:
26W, 2700K, 1800lm, EEK=B
508226





DRAGAN SQUARE

230~



IP44



Socket/Bulb:
E27/EnergySaver (excl.)
up to max. Ø/L: 5/14 cm
2x 20W max.

Material:
Aluminium/PC

Dimensions:
W/H/D: 35,5/35,5/13 cm

Versions:
silver grey

Art. No.:
230394

Recommended bulb:
15W, 2700K, 800lm, EEK=A
508960



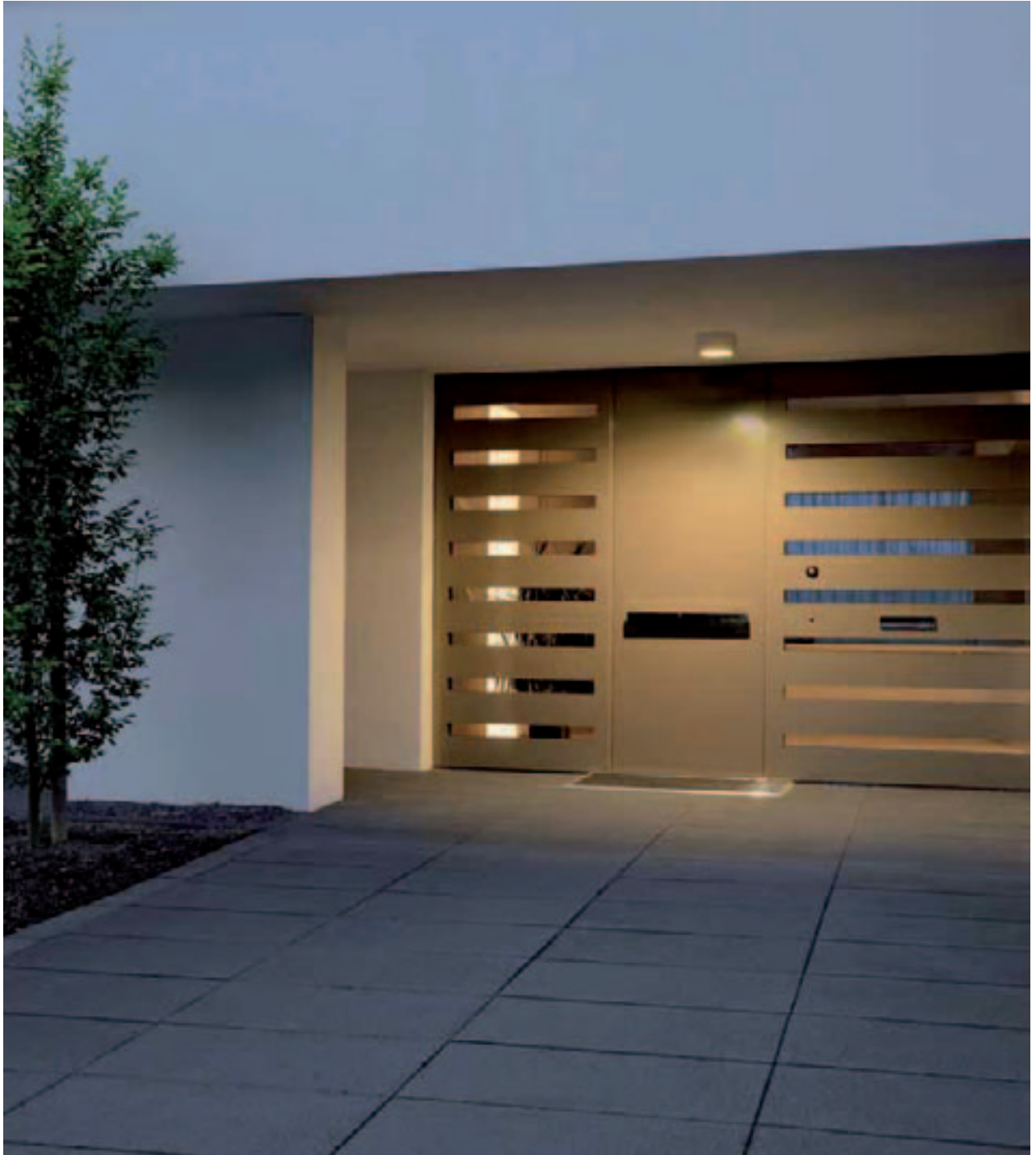

THEOS CL 104 PL

230~



IP44

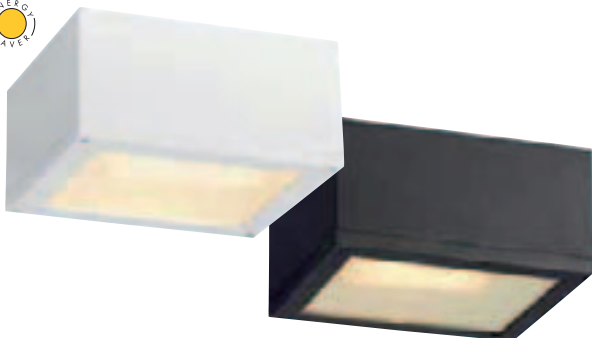

Socket/Bulb:
G24q-3/TC-DE EnergySaver (excl.)
26W

Material:
Aluminium/glass

Dimensions:
W/H/D: 23,5/11,3/19,5 cm

Accessory/Included parts:
Electronic ballast (incl.)

Versions:
white
anthracite

Art. No.:
232541
232545

Recommended bulb:
26W, 3000K, 1800lm, EEK=B
508222





OUT-BEAM ROUND G9

230~ IP44

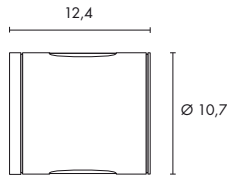
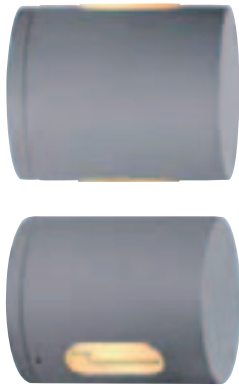

Socket/Bulb:
G9/G9 (excl.)
40W
or
G9/G9 EnergySaver (excl.)

Material:
Aluminium/glass

Versions:
silver grey

Art. No.:
227074

Recommended bulb:
33W EnergySaver \approx 40W
2700K, 460lm, EEK=C
519451



Recommended bulb:
9W, 2700K, 405lm, EEK=A
508940



OUT-BEAM G9

230~ IP44

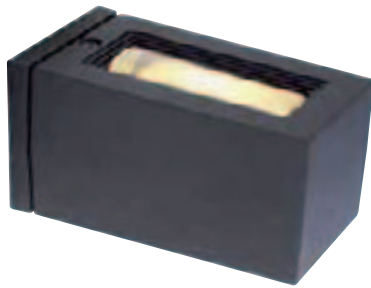

Socket/Bulb:
G9/G9 (excl.)
60W max.

Material:
Aluminium/glass

Dimensions:
W/H/D: 8/8/15,3 cm

Versions:
silver grey
anthracite

Art. No.:
227064
227065

Recommended bulb:
42W EnergySaver \approx 60W
2700K, 620lm, EEK=C
519360



OUT-BEAM R7s Design by CDC

230~ IP44



Socket/Bulb:
R7s/R7s, 78 mm (excl.)
150W max.

Material:
Aluminium/glass

Dimensions:
W¹/W²/H/D: 8/15/15/15,5 cm

Versions:
silver grey

Art. No.:
227020

Recommended bulb:
100W EnergySaver \approx 150W
2700K, 1900lm, EEK=C
519215



OUT-BEAM G8,5 Design by CDC

230~ IP44

**HiEFFICIENT
PROFIlight.**



Socket/Bulb:
G8,5/CDM-TC (excl.)
35W

Material:
Aluminium/glass

Dimensions:
W¹/W²/H/D: 8/15/15/20,5 cm

Accessory/Included parts:
Conventional ballast (incl.)

Versions:
silver grey

Art. No.:
227015

Recommended bulb:
 35W, 3000K, 3400lm
507035

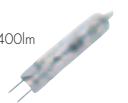



ROX PRO G8,5

230~

Ballast
EEI=A3

5,5

IP44

HiEFFICIENT
PROFIlight.

Socket/Bulb:
 G8,5/CDM-TC (excl.)
 2x 35W

Material:
 Aluminium

Dimensions:
 Ø/H/D: 14/41/19,5 cm
 Canopy-W/H/D: 5,2/12,5/5,4 cm

Accessory/Included parts:
 Conventional ballast (incl.)

Versions:
 white
 anthracite

Art. No.:
 227881
 227885

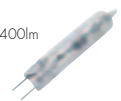
Recommended bulb:
PHILIPS 35W, 3000K, 3400lm
 507035

 Simple installation of the Rox Pro
 G8,5 via plug connection in the
 connection box.



THEOS FLOOD Rx7s

230~ IP44

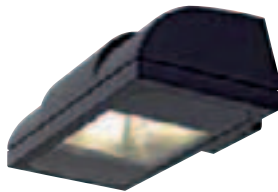
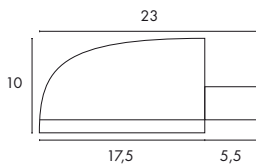
HiEFFICIENT
PROFIlight.



Socket/Bulb:
Rx7s/HQI-TS (excl.)
70W
or
Rx7s/CDM-TD (excl.)
70W

Versions:
white
anthracite

Art. No.:
228001
228005

Material:
Aluminium/glass

Recommended bulb:
70W, 4200K, 6500lm, Ra85
509071



Accessory/Included parts:
Conventional ballast (incl.)

THEOS FLOOD TC-D

230~ IP44

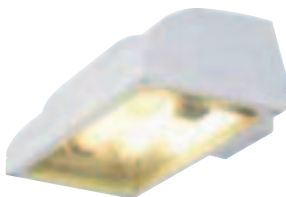
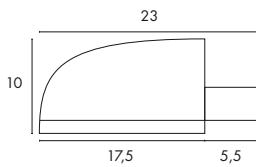

Socket/Bulb:
G24d-3/TC-D EnergySaver (excl.)
2x 26W

Versions:
white
anthracite

Art. No.:
228011
228015

Material:
Aluminium/glass

Recommended bulb:
26W, 4000K, 1800lm, EEK=B
508326



Accessory/Included parts:
Low-loss ballast (incl.)

BOX R7s

230~ IP44

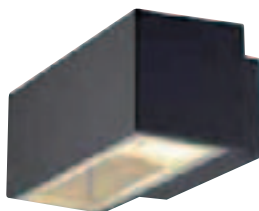
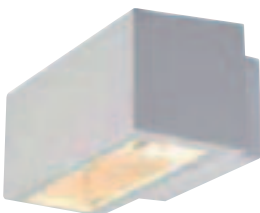

Socket/Bulb:
R7s/R7s, 78mm (excl.)
80W max.

Versions:
white
anthracite
rust-coloured

Art. No.:
232481
232485
232487

Material:
Aluminium/glass

Dimensions:
W/H/D: 22/9/12 cm

Recommended bulb:
 Plusline ES
80W EnergySaver ± 100W
2700K, 1300lm, EEK=C
519231



SITRA DISPLAY Design by CDC

230~



180°



IP54



Socket/Bulb:
GX53/GX53 EnergySaver (excl.)
9W max.
or LED GX53, 2,8W (excl.)
or PowerLED GX53,
3x 1,4W (excl.)

Material:
Cast metal/aluminium

Dimensions:
W/H/D: 10/47/44 cm

Note:
Lamp head is rotatable.

Versions:
stone grey

Art. No.:
230384

Recommended bulb:
9W, 2700K, 260lm
508860



MYRA STRAIGHT

230~



350°

45°



IP55



Socket/Bulb:
GU10/GU10 (excl.)
50W max.

Material:
Aluminium

Dimensions:
L/W/H: 50/8,5/11,5 cm
Head-L/Ø: 8/7 cm
Canopy-W/H/D: 8/10,5/5 cm

Versions:
silver grey
anthracite

Art. No.:
228842
228845

Recommended bulb:
35W EnergySaver ≠ 50W
20°, 2800K, 1200cd
575370



MYRA CURVED

230~



350°

45°



IP55



Socket/Bulb:
GU10/GU10 (excl.)
50W max.

Material:
Aluminium

Dimensions:
Total-L: ~80 cm
Head-L/Ø: 8/7 cm
Canopy-W/H/D: 8/10,5/5 cm

Versions:
silver grey
anthracite

Art. No.:
228812
228815

Recommended bulb:
35W EnergySaver ≠ 50W
20°, 2800K, 1200cd
575370





EASYLITE® DISPLAY GU10 230~ 160° 12 1,05 IP44



Lamp head is rotatable by loosening the bolted connection in the connection box.

Socket/Bulb:
GU10/GU10 (excl.)
50W max.

Material:
Aluminium

Dimensions:
Product-L: 86 cm
Base-Ø/D: 10/5 cm
Head-Ø/L: 10/15 cm

Versions:
stone grey

Art. No.:
230535

Recommended bulb:
35W EnergySaver ± 50W
20°, 2800K, 1200cd
575370



EASYLITE® DISPLAY G12 230~ Ballast EEL-P/A3 160° 12 3,95 IP44

HiEFFICIENT
PROFILight.



Lamp head is rotatable by loosening the bolted connection in the connection box.

Socket/Bulb:
G12/HGIT; CDM-T (excl.)
70W

Material:
Aluminium

Dimensions:
Product-L: 97 cm
Base-Ø/D: 19/11,5 cm
Head-Ø/L: 18/25 cm

Accessory/Included parts:
Conventional ballast (incl.)

Versions:
stone grey

Art. No.:
230605

Recommended bulb:
70W, 3000K, 6600lm
507130



Recommended bulb:
70W, 3000K, 7300lm
507430





VANO TC Design by CDC

230~

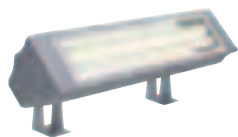

IP65



Socket/Bulb:
2G11/TC-L EnergySaver (excl.)
36W

Versions:
silver grey

Art. No.:
229405

Material:
Aluminium/glass

Dimensions:
W/H/D: 52,5/10/11 cm

Accessory/Included parts:
Low-loss ballast (incl.)
Mounting bracket (excl.)

Recommended bulb:
36W, 2700K, 2900lm, EEK=A
590144

VANO DISPLAY Design by CDC

230~



IP65

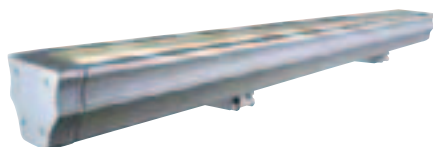

Socket/Bulb:
G5/T5 EnergySaver (excl.)
2x 35W

Versions:
silver grey

Art. No.:
229400

Material:
Aluminium/glass

Dimensions:
W/H/D: 156/10/11 cm

Accessory/Included parts:
Electronic ballast (incl.)
Mounting bracket (excl.)

Recommended bulb:
35W, 3000K, 3320lm
548035

(PU see page 661)

VANO WING PL

230~



IP65

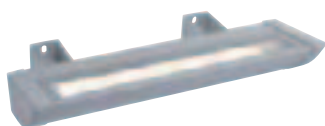

Socket/Bulb:
2G11/TC-L EnergySaver (excl.)
36W

Versions:
silver grey

Art. No.:
229392

Material:
Aluminium/glass

Dimensions:
W/H/D: 50/7,5/15,5 cm

Accessory/Included parts:
Low-loss ballast (incl.)
Mounting bracket (excl.)

Note:
Asymmetric reflector.

Recommended bulb:
36W, 2700K, 2900lm, EEK=A
590144

VANO WING

230~



IP65

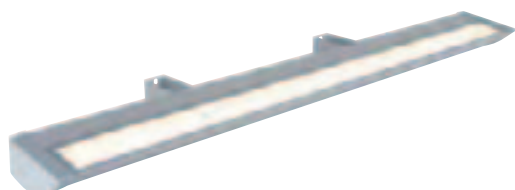

Socket/Bulb:
G5/T5 EnergySaver (excl.)
54W

Versions:
silver grey

Art. No.:
229394

Material:
Aluminium/glass

Dimensions:
W/H/D: 123,5/7,5/15,5 cm

Accessory/Included parts:
Electronic ballast (incl.)
Mounting bracket (excl.)

Note:
Asymmetric reflector.

Recommended bulb:
54W, 3000K, 4450lm
548054

(PU see page 661)





ACCESSORY for Vano TC / Vano Display

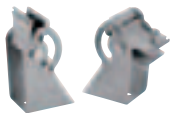

Bracket, short
Steel, silver grey, 2pce. pack
Product-H: 9 cm
Base-L/W: 5/5 cm

Art. No.:
229402



Bracket, adjustable, short
Steel, silver grey, 2pce. pack
Product-H: 19-27 cm
Base-L/W: 6/10 cm

Art. No.:
229403



Bracket, adjustable, long
Steel, silver grey, 1pce. pack
Product-L: 47-80 cm
Base-L/W: 12/10 cm

For the wall installation of the Vano Display,
3 brackets (229406) are needed.

Art. No.:
229406

ACCESSORY for Vano Wing / Vano Wing PL



Bracket
Steel, silver grey, 2pce. pack
Product-H: 13,5 cm
Base-L/W: 8/5 cm

Art. No.:
229395



LED OUTDOOR BEAM

FLOODLIGHT OUTDOOR

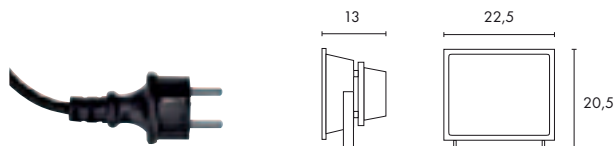

LED OUTDOOR BEAM 30W



Bulb:
PlanarLED (incl.)
30W

Material:
Aluminium/glass

Accessory/Included parts:
LED driver (incl.)
Mains plug IP44 (incl.)
Mains cable-L: 2 m

Note:
We recommend the floor mounting
with **two** earth spikes.

Versions:
silver grey, LED white
2100lm, 6000K **Art. No.:**
231111

silver grey, LED warm white
1800lm, 3300K **Art. No.:**
231112

LED OUTDOOR BEAM 10W



Bulb:
PlanarLED (incl.)
10W

Material:
Aluminium/glass

Accessory/Included parts:
LED driver (incl.)
Mains plug IP44 (incl.)
Mains cable-L: 2 m

Note:
We recommend the floor mounting
with **one** earth spike.

Versions:
silver grey, LED white
610lm, 5700K **Art. No.:**
231101

silver grey, LED warm white
540lm, 3300K **Art. No.:**
231102

ACCESSORY for LED Outdoor Beam 30W



Extension
Steel galvanized, silver grey
L/W/H: 50,5/2,5/2,5 cm
Base-L/W/H: 2/12/0,45 cm

Art. No.:
227774

ACCESSORY for LED Outdoor Beam 10W/30W



Earth spike
Plastic, black
Spike-L: 17,5 cm

Art. No.:
900011





LED FLOOD LIGHT 10W



Bulb:
PlanarLED (incl.)
10W

Material:
Aluminium/glass

Dimensions:
Product-W/H/D: 17/20/7 cm

Accessory/Included parts:
LED driver (incl.)
Mains plug IP44 (incl.)
Mains cable-L: 2 m

Note:
We recommend the floor mounting
with **one** earth spike.

Versions:
black matt, LED white,
610lm, 5700K

Art. No.:
231151

black matt, LED warm white,
540lm, 3300K

231152

LED FLOOD LIGHT 30W



Bulb:
PlanarLED (incl.)
30W

Material:
Aluminium/glass

Dimensions:
Product-W/H/D: 25/31,5/9 cm

Accessory/Included parts:
LED driver (incl.)
Mains plug IP44 (incl.)
Mains cable-L: 2 m

Note:
We recommend the floor mounting
with **two** earth spikes.

Versions:
black matt, LED white,
2100lm, 6000K

Art. No.:
231161

black matt, LED warm white,
1800lm, 3300K

231162

ACCESSORY for LED Flood Light 30W



Extension
Steel galvanized, black
L/W/H: 50,5/2,5/2,5 cm
Base-L/W/H: 12/12/0,45 cm

Art. No.:
227770

ACCESSORY for LED Flood Light 10W/30W



Earth spike
Plastic, black
Spike-L: 17,5 cm

Art. No.:
900011



SXL COMPACT G9

230~ IP44

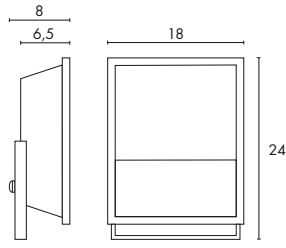

Socket/Bulb:
G9/G9 (excl.)
2x 42W max.
or
G9/G9 EnergySaver (excl.)
2x 9W max.

Material:
Aluminium/glass

Versions:
silver grey

Art. No.:
227804

Recommended bulb:
9W, 4000K, 405lm, EEC=A
508941



Recommended bulb:
42W EnergySaver ≈ 60W
2700K, 620lm, EEC=C
519360



SXL COMPACT R7s

230~ IP44

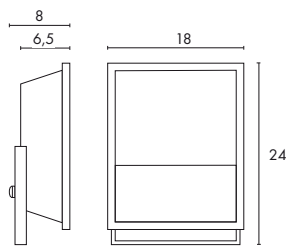

Socket/Bulb:
R7s/R7s, 118 mm (excl.)
130W max.

Material:
Aluminium/glass

Versions:
silver grey

Art. No.:
227814

Recommended bulb:
Philips Plusline ES
120W EnergySaver ≈ 150W
2900K, 2250lm, EEC=C
519240



SXL COMPACT GU6,5

230~ IP44

HiEFFICIENT
PROFILight

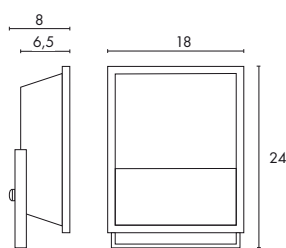

Socket/Bulb:
GU6,5/CMH-T (excl.)
20W

Material:
Aluminium/glass

Accessory/Included parts:
Electronic ballast (incl.)

Versions:
silver grey

Art. No.:
227824

Recommended bulb:
20W, 3000K, 1615lm
507020







SXL 2 E27

230~



IP65

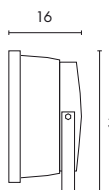
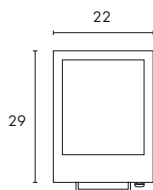

Socket/Bulb:
E27/EnergySaver (excl.)
up to max. Ø/L: 6,6/17,3 cm
24W max.

Material:
Aluminium/glass

Versions:
black
silver grey

Art. No.:
227760
227764

Recommended bulb:
23W, 2700K, 1350lm, EEK=A
508770



SXL 2 2x 26W

230~



IP65

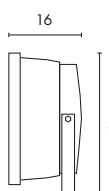
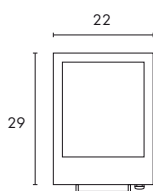

Socket/Bulb:
G24q-3/TC-DE EnergySaver (excl.)
2x 26W

Material:
Aluminium/glass

Versions:
black
silver grey

Art. No.:
227750
227754

Accessory/Included parts:
Electronic ballast (incl.)

Recommended bulb:
26W, 3000K, 1800lm, EEK=B
508222



SXL ECO asymmetrical

230~



IP65



Socket/Bulb:
E27/EnergySaver (excl.)
up to max. Ø/L: 5,2/17,5 cm
2x 24W max.

Material:
Aluminium

Versions:
silver grey

Art. No.:
229192

Dimensions:
W/H/D: 31/42/12,5 cm

Note:
Asymmetric reflector.

Recommended bulb:
23W, 2700K, 1350lm, EEK=A
508770



ACCESSORY for SXL 2 floodlight



Extension Art. No.:
Steel galvanized, black 227770
Steel galvanized, silver grey 227774

L/W/H: 50,5/2,5/2,5 cm
Base-L/W/H: 12/12/0,45 cm

ACCESSORY for SXL Eco

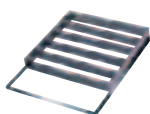

Diffuser Art. No.:
Steel galvanized, chrome 229008

L/W/H: 32,6/25,6/3,1 cm



Extension rod Art. No.:
Steel, black 227690
Steel, white 227691
Steel, silver grey 227698

L/W/H: 80,5/3/3 cm
Base-L/W: 12/12 cm





The HIT/HQI outdoor floodlights are equipped with a normal safety glass. To ensure an UV-protection a bulb equipped with UV filter glass to protect against harmful UV rays must be used. For further questions to the topic UV protection please do not hesitate to contact us.

SXL HIT-DE FLOODLIGHT 70W asymmetrical

230~



HiEFFICIENT
PROFIlight.



Socket/Bulb:
Rx7s/HQI-TS; CDM-TS (excl.)
70W

Material:
Aluminium/glass

Dimensions:
W/H/D: 31/42/12,5 cm

Accessory/Included parts:
Conventional ballast (incl.)

Note:
Asymmetric reflector.

Versions:
silver grey

Art. No.:
229044

Recommended bulb:
70W, 3000K, 6000lm
509070



SXL HIT-DE FLOODLIGHT 150W asymmetrical

230~



HiEFFICIENT
PROFIlight.



Socket/Bulb:
Rx7s/HQI-TS, CDM-TS (excl.)
150W

Material:
Aluminium/glass

Dimensions:
W/H/D: 31/42/12,5 cm

Accessory/Included parts:
Conventional ballast (incl.)

Note:
Asymmetric reflector.

Versions:
black
white
silver grey

Art. No.:
229000
229001
229002

Recommended bulb:
150W, 3000K, 12000lm
509150

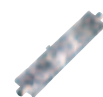

ACCESSORY for SXL HIT-DE floodlight 70W/150W

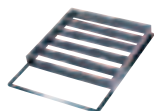

Diffuser
Steel galvanized, chrome

Art. No.:
229008

L/W/H: 32,6/25,6/3,1 cm

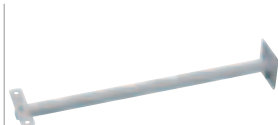

Extension rod
Steel, black
Steel, white
Steel, silver grey

Art. No.:
227690
227691
227698

L/W/H: 80,5/3/3 cm
Base-L/W: 12/12 cm



SXL HIT FLOODLIGHT 400W asymmetrical

230~



HiEFFICIENT
PROFIlight.



Socket/Bulb:
E40/HIT (excl.)
400W

Material:
Aluminium/glass

Dimensions:
W/H/D: 41/54/16,5 cm

Accessory/Included parts:
Conventional ballast (incl.)

Note:
Asymmetric reflector.
400W floodlight can only be
used as uplight!

Versions:
silver grey

Art. No.:
229012

Recommended bulb:
400W, 4200K, 42000lm
510400







FLAC BEAM® HQI 70W

230~



IP65



Socket/Bulb:
G12/HQI-T; CDM-T (excl.)
70W

Material:
Aluminium

HiEFFICIENT
PROFIlight.

Dimensions:
Head-Ø: 20/26 cm
Base-L/W: 15/15 cm

Accessory/Included parts:
Conventional ballast (incl.)

Recommended bulb:
70W, 3000K, 6600lm
507130



Versions:
silver grey

Art. No.:
230054

Recommended bulb:
70W, 3000K, 7300lm
507430





EASYLITE® SPOT G12

230~



IP44



Socket/Bulb:
G12/HQI-T; CDM-T (excl.)
70W

Material:
Aluminium

Dimensions:
Product-H: 29 cm
Head-Ø/L: 18/25 cm
Base-Ø/H: 19/11,5 cm

HiEFFICIENT
PROFIlight.

Accessory/Included parts:
Conventional ballast (incl.)
Earth spike (excl.)

Note:
Lamp head is rotatable by loosening the bolted connection in the connection box.

Recommended accessory:
Earth spike, plastic black
Spike-L: 25 cm
230630



Versions:
stone grey

Art. No.:
230595

Recommended bulb:
70W, 3000K, 6600lm
507130



Recommended bulb:
70W, 3000K, 7300lm
507430





EASYLITE® SPOT QR B111



Socket/Bulb:
G53/QR B111 (excl.)
50W max.

Material:
Aluminium

Dimensions:
Product-H: 23,5 cm
Head-Ø/L: 15,5/23 cm
Base-Ø/H: 13/8 cm

Accessory/Included parts:
Electronic transformer (incl.)

Note:
Lamp head is rotatable by
loosening the bolted connection in
the connection box.

Versions:
stone grey

Art. No.:
230555

Recommended accessory:
Earth spike, plastic black
Spike-L: 25 cm
230630



Recommended bulb:
50W EnergySaver Æ 75W
24°, 3000K, 5800cd
545752



EASYLITE® SPOT ES111



Socket/Bulb:
GU10/ES111 (excl.)
75W max.

Material:
Aluminium

Dimensions:
Product-H: 23,5 cm
Head-Ø/L: 15,5/23 cm
Base-Ø/H: 13/8 cm

Note:
Lamp head is rotatable by
loosening the bolted connection in
the connection box.

Versions:
stone grey

Art. No.:
230575

Recommended accessory:
Earth spike, plastic black
Spike-L: 25 cm
230630



Recommended bulb:
75W, 24°, 2700K, 2000cd
575672





EASYLITE® SPOT E27



Socket/Bulb:
E27/EnergySaver (excl.)
up to max. Ø/L: 4,5/13,5 cm

Material:
Aluminium

Dimensions:
Product-H: 25,5 cm
Head-Ø/L: 18/25 cm
Base-Ø/H: 13/8 cm

Note:
Lamp head is rotatable by
loosening the bolted connection in
the connection box.

Versions:
stone grey

Art. No.:
230615

Recommended accessory:
Earth spike, plastic black
Spike-L: 25 cm
230630



Recommended bulb:
11W, 2700K, 530lm, EEK=A
508950



NAUTILUS PAR38 STAINLESS STEEL



Socket/Bulb:
E27/PAR38 (excl.)
80W max.

Material:
Stainless steel 304

Dimensions:
Lamp-H: 25 cm
Head-Ø: 15,5 cm
Supply line-L: 1,5 m

Note:
Open cable end.

Versions:
stainless steel

Art. No.:
229100

Recommended bulb:
80W, 30°, 2500K
519760



Recommended bulb:
23W EnergySaver
2700K, 1250lm
519620





CUBIX 1

230~



IP44



Socket/Bulb:
GU10/GU10 EnergySaver (excl.)
25W max.

Material:
Aluminium/
Frame protective galvanized,
varnished

Dimensions:
W/H/D: 10,5/14/11 cm
Mains cable-L: 1,5 m

Accessory/Included parts:
Protective contact plug (incl.)

Versions:
silver grey

Art. No.:
132832

Recommended bulb:
 LEDspot 4W
36°, 3000K, 300cd, 165lm
560084



Recommended bulb:
25W EnergySaver ≈ 35W
20°, 2800K, 800cd
575360



CUBIX 2

230~



IP44

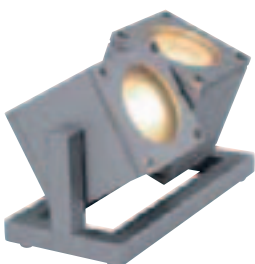

Socket/Bulb:
GU10/GU10 EnergySaver (excl.)
2x 25W max.

Material:
Aluminium/ protective galvanized,
varnished

Dimensions:
W/H/D: 18/14/11 cm
Mains cable-L: 1,5 m

Accessory/Included parts:
Protective contact plug (incl.)

Versions:
silver grey

Art. No.:
132842

Recommended bulb:
 LEDspot 4W
36°, 3000K, 300cd, 165lm
560084



Recommended bulb:
25W EnergySaver ≈ 35W
20°, 2800K, 800cd
575360





EASYLITE® SPOT GU10

230~ 160° 12 0,65 IP44



Socket/Bulb:
GU10/GU10 (excl.)
50W max.

Material:
Aluminium

Dimensions:
Product-H: 20 cm
Head-Ø/L: 10/15 cm
Base-Ø/H: 10/5 cm

Note:
Lamp head is rotatable by loosening the bolted connection in the connection box.

Versions:
stone grey

Art. No.:
230525

Recommended accessory:
Earth spike, plastic black
Spike-L: 25 cm
230630



Recommended bulb:
35W EnergySaver ≈ 50W
20°, 2800K, 1200cd
575370



EASYLITE® SPIKE GU10

230~ 160° 0,75 IP43



Socket/Bulb:
GU10/GU10 (excl.)
50W max.

Material:
Aluminium

Dimensions:
Product-H: 45,5 cm
Head-Ø/L: 10/15 cm
Spike-H: 15 cm
Mains cable-L: 1,2 m

Accessory/Included parts:
Mains plug (incl.)

Versions:
stone grey

Art. No.:
230545

Recommended bulb:
35W EnergySaver ≈ 50W
20°, 2800K, 1200cd
575370



Recommended bulb:
 LEDspot 4W
36°, 3000K, 300cd, 165lm
560084





NAUTILUS

FLOODLIGHT OUTDOOR



NAUTILUS SPIKE

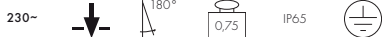

Socket/Bulb:
GU10/GU10 (excl.)
35W max.
up to max. L: 5,7 cm

Material:
Aluminium

Dimensions:
Head-Ø/L: 9,5/10 cm
Spike-L: 17,5 cm
Mains cable-L: 1,5 m

Accessory/Included parts:
Mains plug (incl.)
Plastic spike (incl.)

Versions:
silver grey

Art. No.:
227418

Recommended bulb:
35W EnergySaver ≈ 50W
20°, 2800K, 1200cd
575370



Recommended bulb:
PHILIPS LEDspot 4W
36°, 3000K, 300cd, 165lm
560084



NAUTILUS SPIKE XL



Socket/Bulb:
GU10/GU10 EnergySaver (excl.)
or GU10 LED (excl.)
up to max. L: 8,3 cm

Material:
Aluminium

Dimensions:
Head-Ø/L: 9,5/15,5 cm
Spike-L: 17,5 cm
Mains cable-L: 1,5 m

Accessory/Included parts:
Mains plug (incl.)
Plastic spike (incl.)

Versions:
black

Art. No.:
227410

Recommended bulb:
11W EnergySaver, 2700K, 220lm
508920



Recommended bulb:
PHILIPS LEDspot 4W
36°, 3000K, 300cd, 165lm
560084







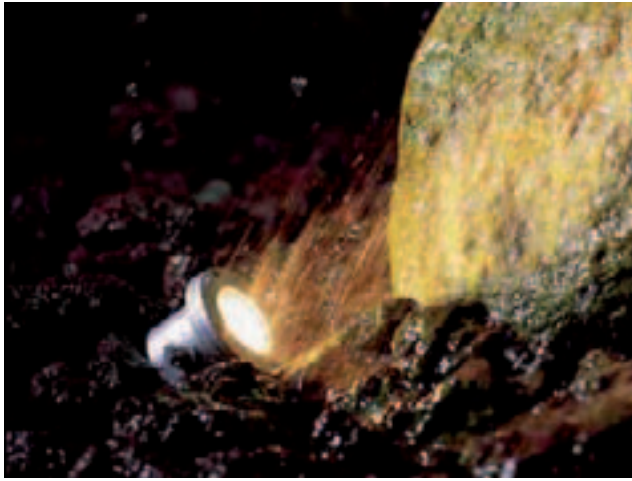

The transformer are splashproof according to protection class IP44, but they are not suitable for embedding or underwater use. Further transformer options can be found in the accessory range.

NAUTILUS IP67



Socket/Bulb:
G5,3/MR16 (excl.)
35W max.

Material:
Aluminium

Dimensions:
Lamp-H: 10 cm
Head-Ø: 9,7 cm
Supply line-L: 3 m

Accessory/Included parts:
Transformer (excl.)

Note:
When connecting several lamps,
please pay attention to the total
wattage.

Versions:
silver grey

Art. No.:
227500

Recommended connection:
IP44 Transformer 60VA/12V~
227160



Recommended bulb:
35W, 38°, 2700K, 810cd
536338



Recommended accessory:
Earth spike, plastic black
Spike-L: 17,5 cm
900011



Recommended bulb:
Philips PowerLED 4W
36°, 3000K, 500cd
560044



NAUTILUS MR16 STAINLESS STEEL



Socket/Bulb:
G5,3/MR16 (excl.)
35W max.

Material:
Stainless steel 304

Dimensions:
Lamp-Ø/H: 10/12,5 cm
Head-Ø: 9 cm
Supply line-L: 1,5 m

Accessory/Included parts:
Transformer (excl.)

Note:
When connecting several lamps,
please pay attention to the total
wattage.

Versions:
stainless steel

Art. No.:
229090

Recommended connection:
IP44 Transformer 150VA/12V~
227150



Recommended bulb:
35W, 38°, 2700K, 810cd
536338



Recommended bulb:
Philips PowerLED 4W
36°, 3000K, 500cd
560044



EASYLITE® SPOT MR16



Socket/Bulb:
GU5,3/MR16 (excl.)
50W max.

Material:
Aluminium

Dimensions:
Product-H: 20,5 cm
Head-Ø/L: 10/15 cm
Base-Ø/H: 13/8 cm

Accessory/Included parts:
Electronic transformer (incl.)

Note:
Lamp head is rotatable by
loosening the bolted connection in
the connection box.

Versions:
stone grey

Art. No.:
230505

Recommended accessory:
Earth spike, plastic black
Spike-L: 25 cm
230630



Recommended bulb:
50W, 40°, 2700K, 1500cd
536540





SITRA EARTH SPIKE Design by CDC

230~



IP54



Socket/Bulb:
GX53/GX53 EnergySaver (excl.)
9W max.
or LED GX53, 2,8W (excl.)
or PowerLED GX53, 3x 1,4W (excl.)

Material:
Aluminium

Dimensions:
W/H/D: 17/27/10 cm
Spike-L: 17,5 cm
Supply line-L: 1,5 m

Accessory/Included parts:
Protective contact plug (incl.)
Plastic spike (incl.)

Versions:
stone grey
anthracite

Art. No.:
230374
230375

Recommended bulb:
9W, 2700K, 260lm
508860



Recommended bulb:
3x 1,4W PowerLED
3250K, 200lm
550092



NAUTILUS GX53 STAINLESS

230~



IP67



Socket/Bulb:
GX53/GX53 EnergySaver (excl.)
11W max.
or LED GX53, 2,8W (excl.)
or PowerLED GX53, 3x 1,4W (excl.)

Material:
Stainless steel 304

Dimensions:
Product-H: 17 cm
Head-Ø/L: 14,3/8,5 cm
Base-Ø: 9,5 cm
Mains cable-L: 1,5 m

Accessory/Included parts:
Mains plug (incl.)

Recommended accessory:
Earth spike, plastic black
Spike-L: 17,5 cm
900011



Versions:
stainless steel

Art. No.:
229730

Recommended bulb:
9W, 2700K, 260lm
508860



Recommended bulb:
3x 1,4W PowerLED
3250K, 200lm
550092





NAUTILUS SPIKE LED COMPACT

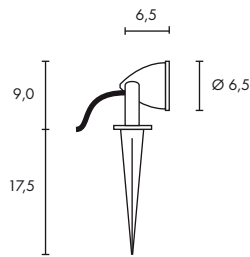

Bulb:
PowerLED (incl.)
3,3W (230V-LED)

Material:
Aluminium

Accessory/Included parts:
Mains plug (incl.)
Mains cable-L: 1,5 m
Plastic spike (incl.)

Versions:
silver grey
LED white
LED warm white

Art. No.:
231021
231022

NAUTILUS SPIKE LED



Bulb:
PowerLED (incl.)
3x 1W

Material:
Aluminium

Dimensions:
Head-Ø/H: 6,5/19 cm
Spike-L: 17,5 cm
Mains cable-L: 1,5 m

Accessory/Included parts:
LED driver (incl.)
Mains plug (incl.)
Plastic spike (incl.)

Versions:
silver grey
LED white
LED warm white

Art. No.:
230271
230272





NAUTILUS LED 304S



Bulb:
PowerLED (incl.)
3x 1W

Versions:
stainless steel brushed
LED white
LED warm white

Art. No.:
230811
230812

Material:
Stainless steel 304/spike plastic

Dimensions:
W/H/D: 10/14,5/9,5 cm
Head-Ø/L: 10/9,5 cm
Spike-L: 17,5 cm
Mains cable-L: 1,5 m

Accessory/Included parts:
LED driver (incl.)
Mains plug (incl.)
Plastic spike (incl.)

NAUTILUS LED 304B



Bulb:
PowerLED (incl.)
3x 1W

Versions:
stainless steel brushed
LED white
LED warm white

Art. No.:
230801
230802

Material:
Stainless steel 304

Dimensions:
Lamp-W/H/D: 10/14,5/9,5 cm
Head-Ø/L: 10/9,5 cm
Base-Ø/H: 9,5/0,8 cm
Supply line-L: 1,5 m

Accessory/Included parts:
LED driver (incl.)

Note:
Supply line with open cable end.

NAUTILUS LED STAINLESS



Bulb:
LED (incl.)
4,6W total

Versions:
stainless steel brushed
LED white
LED warm white

Art. No.:
229731
229732

Material:
Stainless steel 304

Dimensions:
Lamp-H: 17 cm
Head-Ø/L: 14,3/8,5 cm
Base-Ø/H: 9,5/0,8 cm
Mains cable-L: 1,5 m

Recommended accessory:
Earth spike, Plastic black
Spike-L: 17,5 cm
900011

Accessory/Included parts:
Mains plug (incl.)



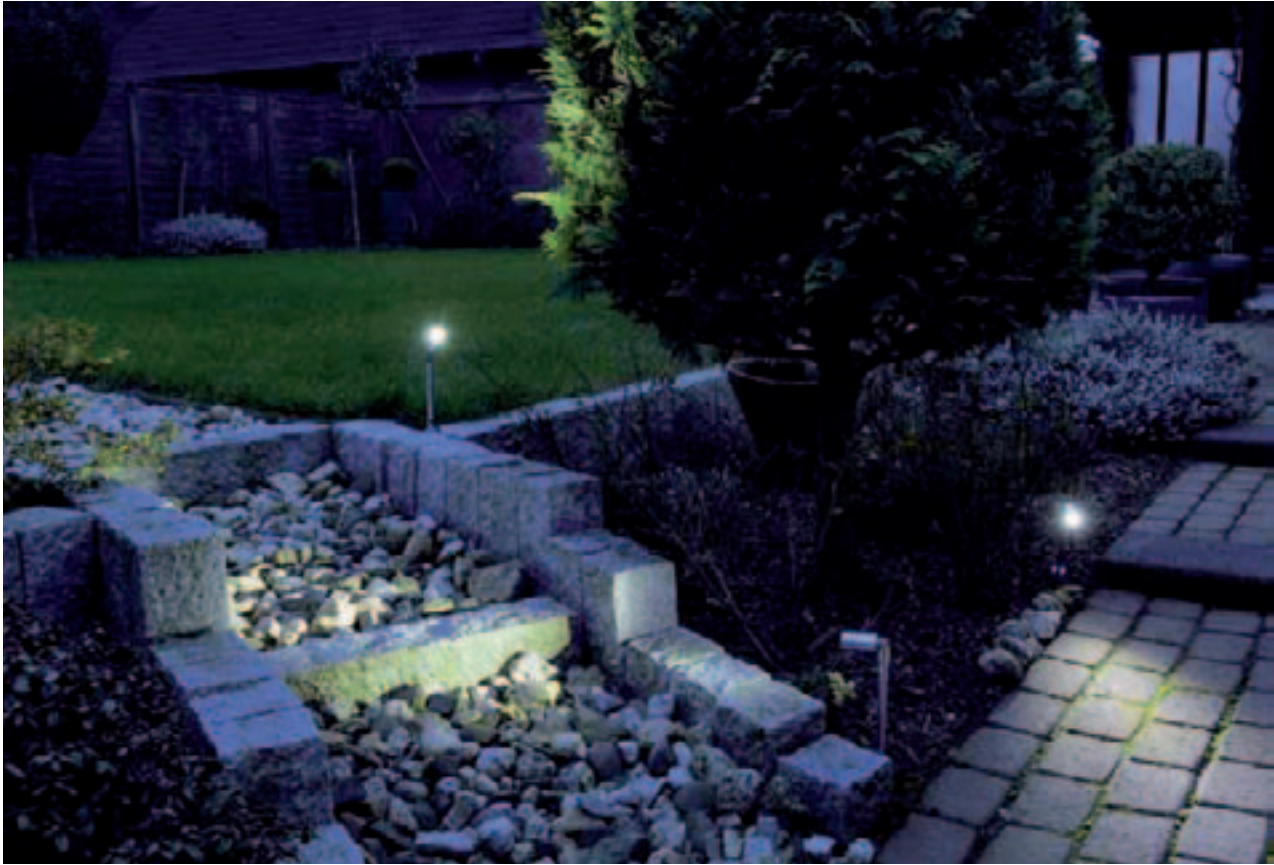

LED OUTDOOR SPIKE SET

230~
12~LED
3 pce.

180°

20°

1,45

IP44



Bulb:
PowerLED (incl.)
3x 1W, 10W total

Material:
Aluminium

Dimensions:
Head-Ø/L: 3,5/5 cm
Rod-L: 36,5 cm
Supply line-L: 1,7 m per spot

Accessory/Included parts:
Conventional transformer (incl.)
Distributor (incl.)

Note:
The floor lamp set consists of three ready-to-plug lamps.
Transformer connection:
2 m primary/1 m secondary.

Versions:
alu natural
LED white
LED warm white

Art. No.:
230281
230282

MINIPOL LED

230~

LED
1 pce.11cm
0,4530cm
0,72

IP44

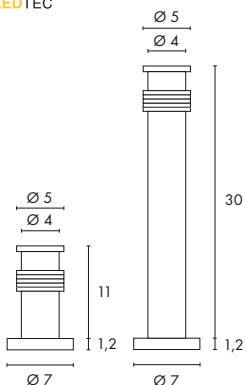
Bulb:
PowerLED (incl.)
3,3W (230V LED)

Material:
Aluminium/acrylic

Dimensions:
Spike-L: 17,5 cm
Supply line-L: 1,5 m

Accessory/Included parts:
Plastic spike (incl.)
Protective contact plug (incl.)

Versions:
alu natural/LED warm white
Minipol LED 11 cm

Minipol LED 30 cm

Art. No.:
230241

230243





When connecting several profiles, please pay attention to the total wattage!
Further power units, drivers and controllers can be found in the accessory range.

GALEN LED PROFILE 100 cm

24=



IP65

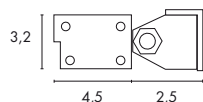
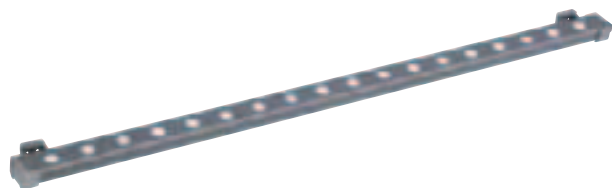

Bulb:
PowerLED (incl.)
18x 1W

Material:
Aluminium/glass

Dimensions:
L/W/H: 100/7/3,2 cm
Supply line-L: 1,5 m

Note:
Power consumption 25W

Accessory/Included parts:
Power unit (excl.)
Wall mounting material (incl.)

Versions:
silver grey
LED white
LED warm white

Art. No.:
229481
229482

Recommended connection:
Power unit 36W, 24V=
470544



Recommended connection:
Power unit 60W, 24V=
470506



GALEN LED PROFILE

350mA



IP65

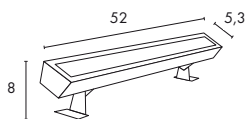
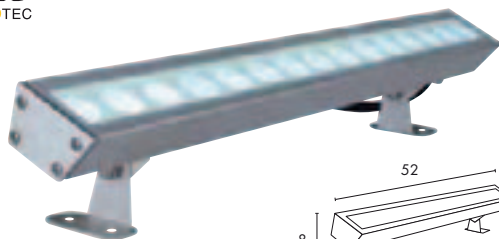

Bulb:
PowerLED (incl.)
15x 1W

Material:
Aluminium/glass

Dimensions:
Supply line-L: 1,5 m

Accessory/Included parts:
LED driver (excl.)
Supply line-L: 1,5 m

Note:
Power consumption 15W

Versions:
alu anodized
LED white
LED warm white

Art. No.:
229461
229462

Recommended connection:
LED driver 18W, 350mA
464111



GALEN RGB LED PROFILE

350mA



IP65

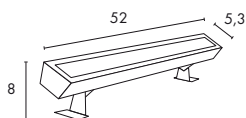
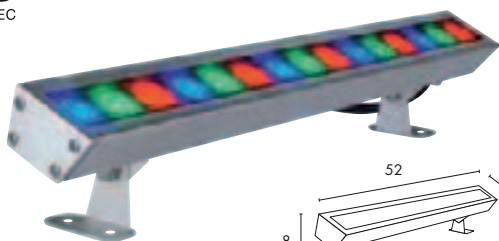

Bulb:
PowerLED (incl.)
5x red, green, blue
15x 1W

Material:
Aluminium/glass

Dimensions:
Supply line-L: 1,5 m

Recommended connection:
Easy LIM® Pro RF, 350mA, 3 channel
Radio-Master controller
5W max./channel, 24V=
470610



Accessory/Included parts:
Power supply (excl.)
Controller (excl.)

Note:
Power consumption 15W

Versions:
alu anodized
LED RGB,
colour controllable

Art. No.:
229463

Recommended connection:
Easy LIM® Pro RF, 350mA, 3 channel
Radio-Slave controller
5W max./channel, 24V=
470612



Recommended connection:
LED power unit, 20W, 24V=
470542

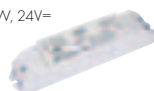

Recommended accessory:
Radio transmitter for
Easy LIM® Pro RF
470601

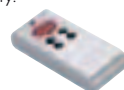

Recommended accessory:
Battery
470620









RGB FLOOD 30W

230~ IP65

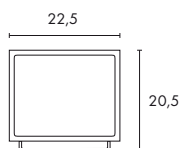
**Bulb:**
PlanarLED, 3in1 RGB (incl.)
30W**Material:**
Aluminium/glass**Dimensions:**
Mains cable-L: 2 m**Accessory/Included parts:**
LED driver (incl.)
PWM converter (incl.)
Control line 2m (incl.)
Mains plug IP44 (incl.)
Controller (excl.)**Note:**
For connection to LIM®2 Controller**Versions:**
silver grey, 1-10V
LED RGB,
colour controllable**Art. No.:**
231113**Recommended connection:**
LIM®2 Controller
4x1-10V control signal
470531**Recommended accessory:**
Remote control
470530

GALEN LED PANEL 24V, 36 LED

24~ 36 pce. IP65

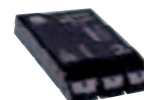
**Bulb:**
PowerLED (incl.)
12x red, green, blue
36x 1W**Material:**
Aluminium/glass**Dimensions:**
W/H/D: 27,5/23,5/15,5 cm
Supply line-L: 5 m**Accessory/Included parts:**
Power unit (excl.)
Controller (excl.)**Note:**
Power consumption 50W.
When connecting several panels,
please pay attention to the total
wattage!**Versions:**
silver grey
LED RGB,
colour controllable**Art. No.:**
229493**Recommended connection:**
Power LIM®2 RGB
Master controller
60W max., 24V=
470581**Recommended accessory:**
Remote control
470520**Recommended connection:**
Power LIM®2 RGB
Slave controller
60W max., 24V=
470582

KETO RGB LED ROUND

350mA 15 pce. IP65

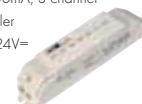
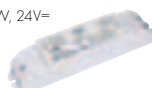
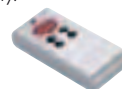
**Bulb:**
PowerLED (incl.)
5x red, green, blue
15x 1W**Material:**
Aluminium/glass**Dimensions:**
W/H/D: 17/18/6 cm
Base-Ø: 10 cm
Supply line-L: 1,5 m**Accessory/Included parts:**
Power supply (excl.)
Controller (excl.)**Note:**
Power consumption 15W.**Versions:**
black
LED RGB,
colour controllable**Art. No.:**
229453**Recommended connection:**
Easy LIM® Pro RF, 350mA, 3 channel
Radio-Master controller
5W max./channel, 24V=
470610**Recommended connection:**
Easy LIM® Pro RF, 350mA, 3 channel
Radio-Slave controller
5W max./channel, 24V=
470612**Recommended connection:**
LED power unit, 20W, 24V=
470542**Recommended accessory:**
Radio transmitter for
Easy LIM® Pro RF
470601**Recommended accessory:**
Battery
470620



CALU

12~



IP65



Socket/Bulb:
G5,3/MR16 (excl.)
20W max.

Material:
Aluminium/glass

Dimensions:
Cover-Ø: 8,6 cm

Accessory/Included parts:
Transformer (excl.)

Note:
Not suitable for direct mirror bulbs.

Recommended connection:
IP44 Transformer 60VA/12V~
227160



Versions:
Glass satined
alu brushed/varnished

Art. No.:
111542

Recommended bulb:
20W, 40°, 2700K, 450cd
535240





When connecting several lamps, please pay attention to the total wattage.
Further transformer options can be found in the accessory range.

DORU

12~



IP65



Socket/Bulb:
G5,3/MR16 (excl.)
20W max.

Material:
Aluminium/glass

Dimensions:
Cover-Ø: 8,5 cm

Accessory/Included parts:
Transformer (excl.)

Versions:
Glass satined
alu natural

Art. No.:
111432

Recommended connection:
IP44 Transformer 60VA/12V~
227160



Recommended bulb:
20W, 40°, 2700K, 450cd
535240



OUT 65

12~



IP65

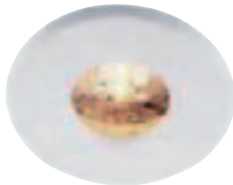

white

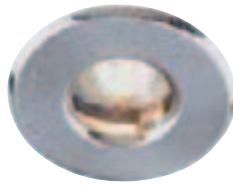

chrome brushed

Socket/Bulb:
G5,3/MR16 (excl.)
35W max.

Material:
Aluminium/glass

Dimensions:
Cover-Ø: 8,5 cm

Accessory/Included parts:
Transformer (excl.)

Versions:
Glass clear
white
chrome brushed
silver grey

Art. No.:
111011
111018
111019

Recommended connection:
IP44 Transformer 60VA/12V~
227160

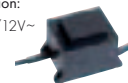

Recommended bulb:
35W, 38°, 2700K, 810cd
536338



FGL OUT MR16, ROUND

12~



IP65

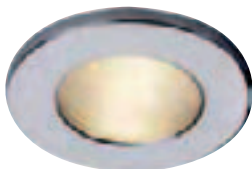

chrome

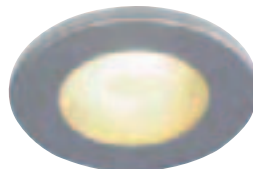

silver grey

Socket/Bulb:
G5,3/MR16 (excl.)
35W max.

Material:
Aluminium/glass

Dimensions:
Cover-Ø/H: 8/0,5 cm

Accessory/Included parts:
Transformer (excl.)

Versions:
Glass satined
white
chrome
titanium
silver grey

Art. No.:
111001
111002
111007
111008

Recommended connection:
IP44 Transformer 60VA/12V~
227160

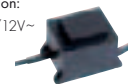

Recommended bulb:
35W, 38°, 2700K, 810cd
536338



FGL OUT MR16, SQUARE

12~



IP65



white



titanium

Socket/Bulb:
G5,3/MR16 (excl.)
35W max.

Material:
Aluminium/glass

Dimensions:
Cover-W/L/H: 9/9/0,5 cm

Accessory/Included parts:
Transformer (excl.)

Versions:
Glass satined
white
chrome
titanium
silver grey

Art. No.:
111121
111122
111127
111128

Recommended connection:
IP44 Transformer 60VA/12V~
227160



Recommended bulb:
35W, 38°, 2700K, 810cd
536338





When connecting several lamps, please pay attention to the total wattage. Further transformer options can be found in the accessory range.

FGL OUT GU10, ROUND

230~



IP44

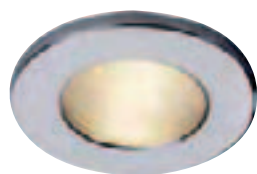

chrome

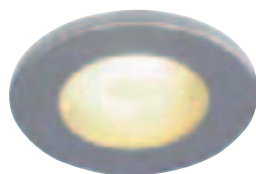

silver grey

Socket/Bulb:
GU10/GU10 (excl.)
35W max.

Material:
Aluminium/glass

Dimensions:
Cover-Ø/H: 8/0,5 cm

Note:
Suitable for ceilings with a material thickness of max. 15 mm.

Versions:
Glass satined
white
chrome
silver grey
titanium

Art. No.:
111021
111022
111024
111027

Recommended bulb:
35W EnergySaver ≈ 50W
20°, 2800K, 1200cd
575370



Recommended bulb:
PHILIPS LEDspot 4W
36°, 3000K, 300cd, 165lm
560084



FGL OUT GU10, SQUARE

230~



IP44



white



titanium

Socket/Bulb:
GU10/GU10 (excl.)
35W max.

Material:
Aluminium/glass

Dimensions:
Cover-W/L/H: 9/9/0,5 cm

Note:
Suitable for ceilings with a material thickness of max. 15 mm.

Versions:
Glass satined
white
chrome
silver grey
titanium

Art. No.:
111141
111142
111144
111147

Recommended bulb:
35W EnergySaver ≈ 50W
20°, 2800K, 1200cd
575370



Recommended bulb:
PHILIPS LEDspot 4W
36°, 3000K, 300cd, 165lm
560084



EYEDOWN LED 3x 1W

350mA



IP44



Bulb:
PowerLED (incl.)
3x 1W

Material:
Aluminium/glass

Dimensions:
Ø/H: 6,8/4,3 cm
Supply line-L: 45 cm

Accessory/Included parts:
Plug (incl.)
LED driver (excl.)

Note:
Suitable for cavity ceilings with a material thickness of max. 30 mm. When connecting several lamps, please take care of a series connection.

Recommended connection:
Connector strip, 3 outlets
111850



Versions:
alu anodized
3000K, 190lm

Art. No.:
111982

Recommended connection:
LED driver 3W, 350mA
464108



EYEDOWN LED 6x 1W

350mA



IP44



Bulb:
PowerLED (incl.)
6x 1W

Material:
Aluminium/glass

Dimensions:
Ø/H: 8,8/5,2 cm
Supply line-L: 45 cm

Accessory/Included parts:
Plug (incl.)
LED driver (excl.)

Note:
Suitable for cavity ceilings with a material thickness of max. 30 mm. When connecting several lamps, please take care of a series connection.

Recommended connection:
Connector strip, 3 outlets
111850



Versions:
alu anodized
3000K, 400lm

Art. No.:
111992

Recommended connection:
LED driver 3W, 350mA
464108





PL-DL IP65

230~



IP65



Socket/Bulb:
G24d-3/TC-D EnergySaver (excl.)
2x 26W

Material:
Plastic

Dimensions:
Outer-Ø: 21,5 cm
L/W/H: 38/20,5/11,4 cm

Accessory/Included parts:
Low-loss ballast (incl.)

Note:
Suitable for cavity ceilings with a material thickness of 10-30 mm.

Versions: white
Art. No.: 227226

Recommended bulb:
26W, 2700K, 1800lm, EEK=B
508226



RAPIDO Out/Electronic ballast

230~



IP20 (IP44)



Socket/Bulb:
G24q-3/TC-DE EnergySaver (incl.)
2x 26W

Material:
Front Aluminium

Dimensions:
Outer-Ø: 23 cm
L/W/H: 30/19/14 cm

Accessory/Included parts:
Osram electronic ballast (incl.)
Protective glass (incl.)
2x Bulb 3000K, EEK=B (incl.)

Note:
Permissible temperature range in mounting area 5°C-50°C.
IP44 can be achieved when the ceiling surface is closed.

Versions: silver grey
Art. No.: 227326



BRICK MESH STAINLESS STEEL

230~



IP54

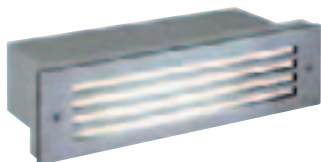

Socket/Bulb:
G23/TC-S EnergySaver (excl.)
9W

Material:
Stainless steel 304/glass

Dimensions:
W/H/D: 26/7,6/9 cm

Accessory/Included parts:
Low-loss ballast (incl.)
Mounting pot (incl.)

Versions:
stainless steel

Art. No.:
229250

Recommended bulb:
9W, 2700K, 600lm, EEK=A
508209





ALDA

230~

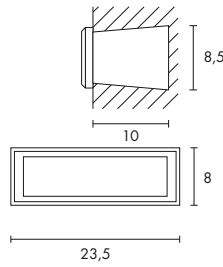

Socket/Bulb:
G24d-2/TC-D EnergySaver (excl.)
18W

Material:
Aluminium/Plastic

Accessory/Included parts:
Low-loss ballast (incl.)
Mounting pot (incl.)

Versions:
stone grey

Art. No.:
230415

Recommended bulb:
18W, 2700K, 1200lm, EEK=B
508218



BRICK DOWNUNDER E14

230~

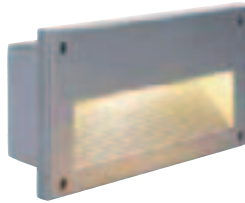

Socket/Bulb:
E14/AGL candle shape (excl.)
40W max.
or
E14/EnergySaver (excl.)
up to max. Ø/L: 4,8/13 cm

Material:
Aluminium/glass

Dimensions:
W/H/D: 22,7/12,5/8,5 cm

Note:
No mounting pot needed!

Versions:
silver grey

Art. No.:
229062

Recommended bulb:
11W, 2700K, 530lm, EEK=A
508810



DOWNUNDER OUT TC-D

230~

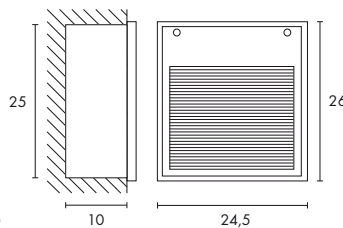

Socket/Bulb:
G24d-3/TC-D EnergySaver (excl.)
26W

Material:
Aluminium/glass

Dimensions:
W/H/D: 24,5/26/10 cm

Accessory/Included parts:
Low-loss ballast (incl.)
Mounting pot (incl.)

Note:
Mounting only with light emission
downwards.

Versions:
silver grey

Art. No.:
230424

Recommended bulb:
26W, 2700K, 1800lm, EEK=B
508226



BRICK DOWNUNDER G9

230~



Socket/Bulb:
G9/G9 (excl.)
40W max.

Material:
Aluminium/glass

Dimensions:
W/H/D: 10,5/17/7 cm

Accessory/Included parts:
Mounting pot (incl.)

Versions:
silver grey

Art. No.:
229712

Recommended bulb:
33W EnergySaver 40W
2700K, 460lm, EEK=C
519451







BRICK MESH LED

230~ (LED) LED 60 pce. 19,5/9 7 0,78 IP54

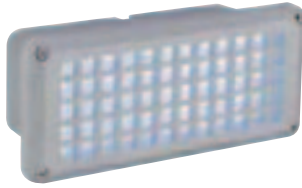

Bulb:
LED (incl.)
8,5W total

Material:
Aluminium/glass

Dimensions:
visible-W/H/D: 20,5/9,5/8 cm

Accessory/Included parts:
Mounting pot (incl.)

Versions:
silver grey
LED white
LED warm white

Art. No.:

230481
230482

BRICK LED 24 STAINLESS STEEL

230~ (LED) LED 24 pce. 10/16 9 0,7 IP54



Bulb:
SMD LED (incl.)
5W total

Material:
Stainless steel 304/glass

Dimensions:
W/H/D: 16,5/10,5/7,5 cm

Accessory/Included parts:
Mounting pot (incl.)

Versions:
stainless steel brushed
LED white
LED warm white

Art. No.:

229121
229122

BRICK LED DOWNUNDER VERTICAL

230~ (LED) LED 12 pce. 10/16 10 0,85 IP54

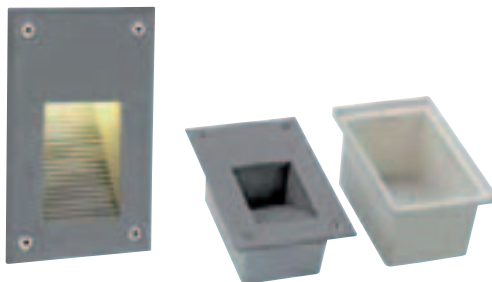

Bulb:
SMD LED (incl.)
8,4W total

Material:
Aluminium

Dimensions:
W/H/D: 10,5/17/8,5 cm

Accessory/Included parts:
Mounting pot (incl.)

Versions:
silver grey
LED warm white

Art. No.:

229722

BRICK LED DOWNUNDER

230~ (LED) LED 18 pce. 16/10 7,5 0,8 IP54

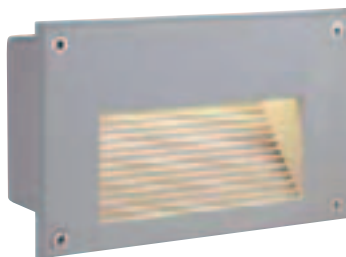

Bulb:
SMD LED (incl.)
3,6W total

Material:
Aluminium

Dimensions:
W/H/D: 17/10,5/7 cm

Accessory/Included parts:
Mounting pot (incl.)

Versions:
silver grey
LED white
LED warm white

Art. No.:

229701
229702

BRICK LED 16 STAINLESS STEEL

230~ (LED) LED 16 pce. 16/5,6 9 0,5 IP44



Bulb:
LED (incl.)
1W total

Material:
Stainless steel 304/Plastic

Dimensions:
W/H/D: 17/6,8/8 cm

Accessory/Included parts:
Mounting pot (incl.)

Versions:
stainless steel brushed
LED white
LED warm white
LED blue

Art. No.:

230231
230232
230237



DOWNUNDER LED 14

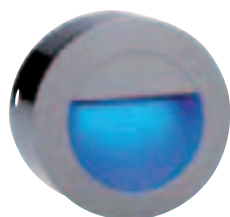

stone grey, LED blue



alu brushed, LED white



stone grey, LED warm white

Bulb:
SMD LED (incl.)
0,8W total

Material:
Aluminium

Dimensions:
Ø/D: 12,5/6 cm
Mounting pot-Ø/D: 12/7,2 cm

Accessory/Included parts:
Mounting pot (incl.)

Note:
IP44 only with light emission
downwards!
Mounting pot for the use in masonry
walls.

Versions:	Art. No.:
stone grey	
LED white	230201
LED warm white	230202
LED blue	230207

alu brushed	
LED white	230301
LED warm white	230302

DOWNUNDER LED 15

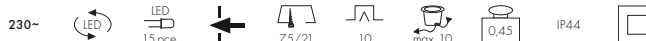

stone grey, LED blue



alu brushed, LED white



white, LED warm white

Bulb:
SMD LED (incl.)
0,9W total

Material:
Aluminium

Dimensions:
W/H/D: 9/23/7,5 cm
Mounting pot-W/H/D:
9,5/23,5/9 cm

Accessory/Included parts:
Mounting pot (incl.)

Note:
IP44 only with light emission
downwards!
Mounting pot for the use in masonry
walls.

Versions:	Art. No.:
stone grey	
LED white	230211
LED warm white	230212
LED blue	230217

alu brushed	
LED white	230311
LED warm white	230312

white	
LED warm white	230182

DOWNUNDER LED 27



stone grey, LED warm white



white, LED warm white

Bulb:
SMD LED (incl.)
1,8W total

Material:
Aluminium

Dimensions:
W/H/D: 18/23/7,5 cm
Mounting pot-W/H/D:
18,5/23,5/9 cm

Accessory/Included parts:
Mounting pot (incl.)

Note:
IP44 only with light emission
downwards!
Mounting pot for the use in masonry
walls.

Versions:	Art. No.:
stone grey	
LED white	230221
LED warm white	230222

white	
LED warm white	230192





GLASS PLOT Design by CDC



Material:
Glass, inside satined

Note:
Can not be walked on!

Dimensions:
Cover-Ø/H: 9,25/2,2 cm

Versions:
satined

Art. No.:
227400

Accessory/Included parts:
Ground protective ring (incl.)
LED insert (excl.)

LED PLOT ROUND Design by CDC

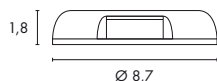
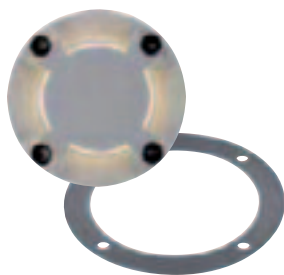

Material:
Aluminium

Versions:
silver grey

Art. No.:

Accessory/Included parts:
Ground protective ring (incl.)
LED insert (excl.)

1 slot
2 slots
4 slots

227381
227382
227384

Note:
Select the plot cover with 1, 2 or 4 light exit openings (slots). Then select the LED insert (see below) with the desired light colour.

LED INSERT for Glass Plot and LED Plot Round Design by CDC



Bulb:
LED (incl.)
2,6W total

Material:
Plastic PC

Dimensions:
Ø/H: 6,2/1,4 cm
Supply line-L: 1,5 m

Accessory/Included parts:
Transformer (excl.)

Note:
Operate only with conventional transformer!
When connecting several lamps, please pay attention to the total wattage.
Further transformer options can be found in the accessory range.

Versions:
LED white
LED warm white
LED blue

Art. No.:
550211
550212
550217

Recommended connection:
IP44 Transformer 10VA/12V-451010



Connection box round
2 conductions for thin lines
6-9,5 mm²
229260



BIG LED PLOT ROUND

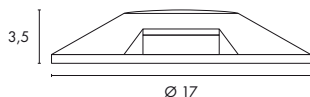
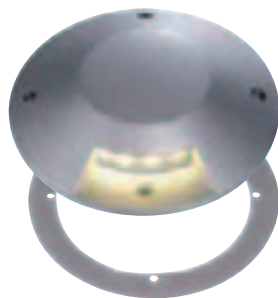

Material:
Aluminium

Versions:
silver grey

Art. No.:

Accessory/Included parts:
Ground protective ring (incl.)
LED insert (excl.)

1 slot
2 slots
4 slots

227371
227372
227374

Note:
Select the plot cover with 1, 2 or 4 light exit openings (slots). Then select the LED insert (see below) with the desired light colour.

LED INSERT for Big LED Plot round Design by CDC



Bulb:
SMD LED (incl.)
3,8W total

Material:
Plastic PC

Dimensions:
Ø/H: 13/3,1 cm
Supply line-L: 1,5 m

Accessory/Included parts:
Transformer (excl.)

Note:
Operate only with conventional transformer! When connecting several lamps, please pay attention to the total wattage.
Further transformer options can be found in the accessory range.

Versions:
LED white
LED warm white
LED blue

Art. No.:
550331
550332
550337

Recommended connection:
IP44 Transformer 10VA/12V-451010



Connection box round
2 conductions for thin lines
6-9,5 mm²
229260







LED SKY PLOT Design by CDC

12~



IP67

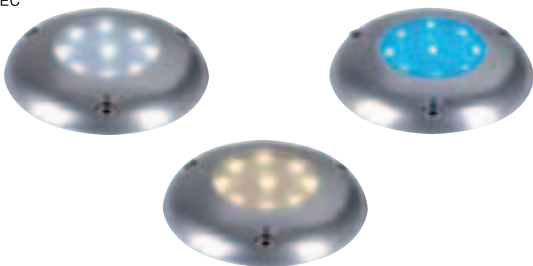

Bulb:
SMD LED (incl.)
1W total

Material:
Aluminium/acrylic

Dimensions:
Ø/H: 8/1,6 cm
Supply line-L: 1,5 m

Accessory/Included parts:
Conventional transformer (excl.)

Note:
Operate only with conventional transformer! When connecting several lamps, please pay attention to the total wattage. Further transformer options can be found in the accessory range.

Versions:	Art. No.:
alu anodized	227391
LED white	227392
LED warm white	227393
LED blue	227397

Recommended connection:
IP44 Transformer 10VA/12V~
451010



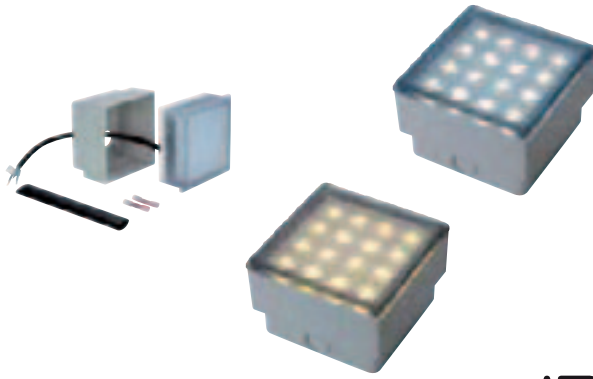

LED STONE Q3



Bulb: LED (incl.) 3W total	Versions: LED white LED warm white	Art. No.: 227341 227342
---	---	--------------------------------------

Material:
Plastic

Dimensions:
L/W/H: 10/10/4 cm
Supply line-L: 25 cm

Accessory/Included parts:
Mounting pot (incl.)
LED driver (incl.)
Heat-shrink tubing (incl.)
2 Crimp connectors (incl.)

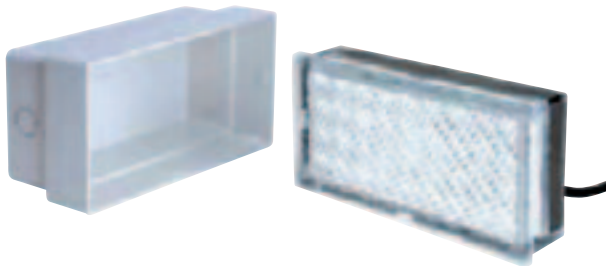
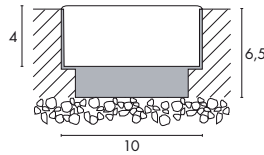

LED TILE



Bulb: LED (incl.) 3,5W total	Versions: LED white LED warm white	Art. No.: 227331 227332
---	---	--------------------------------------

Material:
Plastic

Dimensions:
L/W/H: 20/10/4 cm
Supply line-L: 25 cm

Accessory/Included parts:
Mounting pot (incl.)
LED driver (incl.)
Connection box (excl.)

Note:
In the extra deep mounting pot is also space for the connection box.

Recommended connection:
Connection box IP68
228730

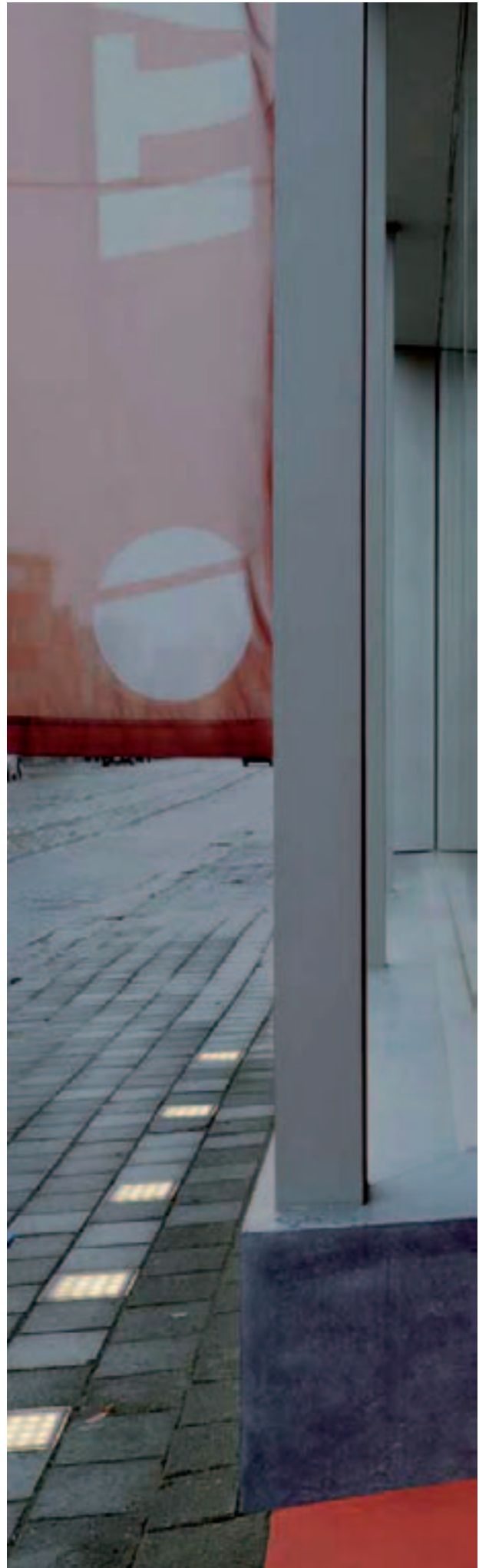





TRAIL-LIGHT

RECESSED LIGHT

When connecting several lamps, please pay attention to the total wattage. Further transformer options can be found in the accessory range.



Version with satin glass insert



Version with faceted diffuser



Power Trail-Lite round



Power Trail-Lite square

TRAIL-LITE Design by CDC



Bulb:
LED (incl.)
0,3W total

Material:
Cover stainless steel 316/glass

Dimensions:
Lamp-Ø/H: 3,6/6 cm
Cover-Ø: 6 cm
Sleeve-Ø/H: 4,7 cm
Supply line-L: 44 cm

Accessory/Included parts:
Installation sleeve (incl.)
Conventional transformer (excl.)

Note:
Operate only with conventional transformer!

Versions:
Cover stainless steel with satin glass insert
LED white
LED warm white
LED blue

Art. No.:
227461
227462
227467

with faceted diffuser
LED white
LED warm white

227471
227472

Recommended connection:
IP44 Transformer 10VA/12V-451010



POWER TRAIL-LITE



Bulb:
PowerLED (incl.)
1W

Material:
Cover stainless steel 316/glass

Dimensions:
Lamp-Ø: 2,8 cm
Sleeve-Ø/H: 3,9/9 cm
Supply line-L: 2 m

Power Trail-Lite round:
Cover-Ø: 4,1 cm
Lamp-H: 6,5 cm

Power Trail-Lite square:
Cover-L/W/H: 4,7/4,7/0,75 cm
Lamp-H: 6,7 cm

Accessory/Included parts:
Installation sleeve (incl.)
LED driver (excl.)

Note:
Operate only with driver/electronic ballast 350mA. When connecting several PowerLEDs, please take care of a series connection!

Versions:
Stainless steel with glass insert
Power Trail-Lite round
LED white
LED warm white
LED blue

Art. No.:
228331
228332
228337

Power Trail-Lite square
LED white
LED warm white

228341
228342

Recommended connection:
LED driver 3W, 350mA
464108

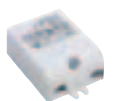

Connection box round
2 conductions for thin lines
6-9,5 mm²
229260



DASAR® GX53

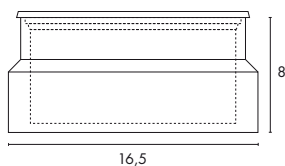

Dimensioned drawing of mounting pot.

Socket/Bulb:
GX53/GX53 EnergySaver (excl.)
9W max.

Material:
Aluminium
Cover stainless steel 316

Dimensions:
Ø/H: 8,3/8 cm
Cover-Ø: 13 cm

Accessory/Included parts:
Mounting pot (incl.)

Versions:
stainless steel

Art. No.:
229360

Recommended bulb:
9W, 2700K, 260lm
508860



DASAR® 115 LED

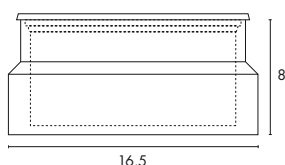

Dimensioned drawing of mounting pot.

Bulb:
LED (incl.)
6W total

Material:
Aluminium
Cover stainless steel 316

Dimensions:
Ø/H: 8,3/8 cm
Cover-Ø: 13 cm

Accessory/Included parts:
Mounting pot (incl.)
Conventional transformer (excl.)

Note:
Operate only with conventional transformer.
When connecting several lamps, please pay attention to the total wattage.
Further transformer options can be found in the accessory range.

Versions:
stainless steel
LED white
LED blue

Art. No.:
229311
229317

Recommended connection:
IP44 Transformer 10VA/12V-
451010



DASAR® FLAT LED Design by CDC



Bulb:
LED (incl.)
0,8W total

Material:
Cover stainless steel 304

Dimensions:
Ø/H: 8/4,8 cm
Cover-Ø: 8 cm
Supply line-L: 2 m

Accessory/Included parts:
Mounting pot (incl.)
Conventional transformer (excl.)

Note:
Operate only with conventional transformer. When connecting several lamps, please pay attention to the total wattage.
Further transformer options can be found in the accessory range.

Versions:
stainless steel brushed
LED white
LED warm white

Art. No.:
228401
228402

Recommended connection:
IP44 Transformer 10VA/12V-
451010



DASAR® 9x 1W LED



Bulb:
PowerLED (incl.)
9x 1W

Material:
Aluminium/cover stainless steel
304

Dimensions:
Lamp-Ø/H: 15/11 cm

Accessory/Included parts:
Mounting pot (incl.)
LED driver (incl.)

Versions:
stainless steel brushed
LED white, 5600K
LED warm white, 3000K

Art. No.:
230151
230152

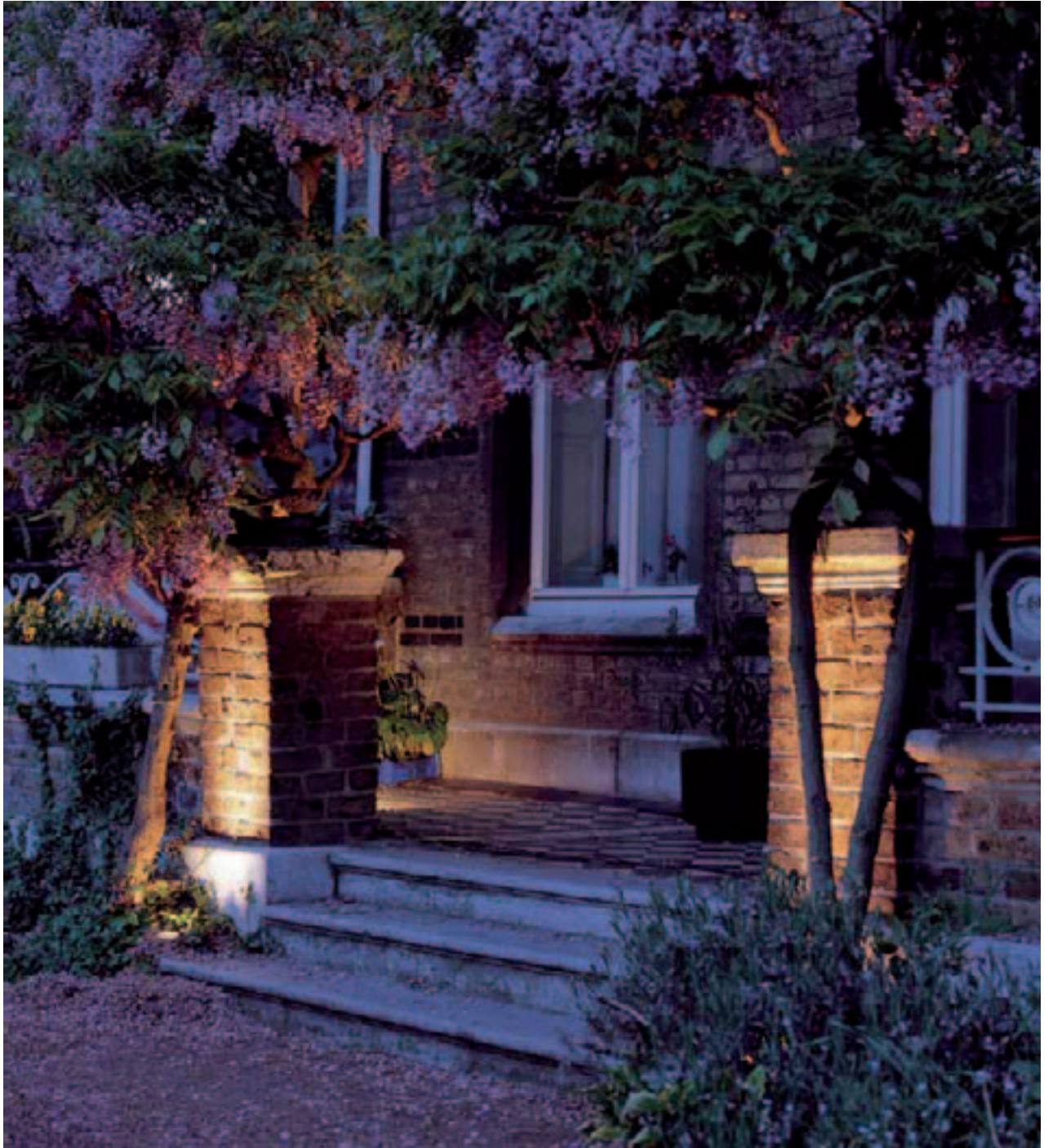

DASAR® MODULE LED

230~



Socket/Bulb:

PHILIPS
Fortimo LED Twistable Module (excl.)
20W max.

Versions:
stainless steel
round cover

Art. No.:
230160

Material:
Aluminium/glass

square cover

230164

Dimensions:
Product Ø/H: 21,6/16 cm (round)
L/W/H: 21,6/21,6/16 cm
(square)

Recommended bulb:
 Fortimo LED Twistable Module
18W, 4000K, 1100lm
560201



Accessory/Included parts:
Mounting pot (incl.)

20W, 3000K, 1100lm
560202





WETSY Design by CDC

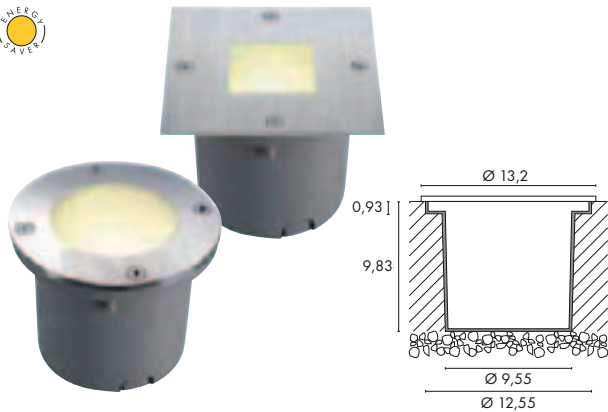

Socket/Bulb:
GX53/GX53 EnergySaver (excl.)
9W max.
or LED GX53, 2,8W (excl.)
or PowerLED GX53, 3x 1,4W (excl.)

Material:
Aluminium
Cover stainless steel 316

Dimensions:
Cover-Ø: 13,2 cm (round)
Cover-L/W: 13,2/13,2 cm (square)
Supply line-L: 1,4 m

Accessory/Included parts:
Mounting pot (incl.)

Versions:
stainless steel/glass satined round cover
square cover window round
window square

Art. No.:
227485
227490
227495

Recommended bulb:
9W, 2700K, 260lm
508860



WETSY LED 230V Design by CDC



Socket/Bulb:
GX5,3/LED insert 12V (excl.)

Material:
Aluminium
Cover stainless steel 316

Dimensions:
Cover-Ø: 13,2 cm (round)
Cover-L/W: 13,2/13,2 cm (square)
Supply line-L: 1,4 m

Accessory/Included parts:
Mounting pot (incl.)
Transformer (incl.)

Versions:
stainless steel square cover
round cover

Art. No.:
227480
227482

Recommended bulb:
LED insert 12V-, 1,4W total
227531 white, 38lm
227532 warm white, 30lm



WETSY POWER LED Design by CDC

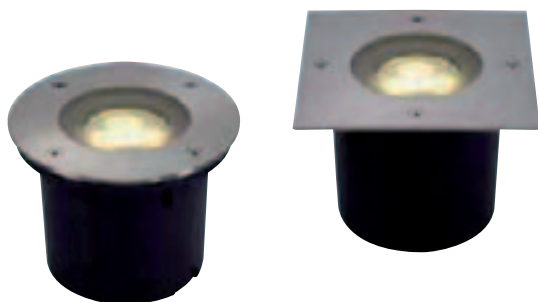

Bulb:
PowerLED (incl.)
3x 1W

Material:
Aluminium
Cover stainless steel 316

Dimensions:
Cover-Ø: 13,2 cm (round)
Cover-L/W: 13,2/13,2 cm (square)
Supply line-L: 1,4 m

Accessory/Included parts:
Mounting pot (incl.)
LED driver (incl.)

Versions:
stainless steel, square cover
LED white
LED warm white
LED blue ▼

Art. No.:
227421
227422
227427

stainless steel, round cover
LED white
LED warm white
LED blue ▼

Art. No.:
227431
227432
227437

WETSY LED DISK 300 Design by CDC

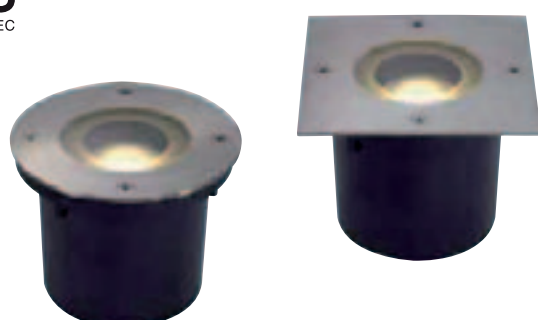

Bulb:
PHILIPS
Fortimo LED Disk Module (incl.)
9W, 300lm, Ra80

Material:
Cover stainless steel 316

Dimensions:
Cover-Ø: 13,2 cm (round)
Cover-L/W: 13,2/13,2 cm (square)
Supply line-L: 1,4 m

Accessory/Included parts:
Mounting pot (incl.)

Versions:
stainless steel round cover
square cover

Art. No.:
230170
230174





AQUADISC G4



Aquadisc G4 with Octagon LED-Module.

Socket/Bulb:
G4/pin socket (excl.)
20W max.

Material:
Aluminium/structure glass
Cover stainless steel 316

Dimensions:
Cover-Ø: 13 cm
Mounting pot-Ø/H: 12,5/5 cm
Supply line-L: 1,5 m

Accessory/Included parts:
Mounting pot (incl.)
Transformer (excl.).

Note:
Can not be walked on

Versions: stainless steel brushed **Art. No.:** 227080

Recommended bulb:
20W, 330lm, 2700K
512220



ACCESSORY for Aquadisc G4 to modify to LED technology

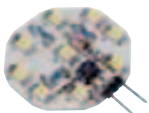

Octagon LED-Module 12V~
white, 21lm
warm white, 19lm
1,5W total
Conventional transformer (excl.)
Operate only with conventional transformer (see right).

Art. No.:
550251
550252



IP44 Transformer 10VA/12V~
L/W/H: 5,5/8/5 cm
Primary cable-L: 2 m,
Secondary cable-L: 2 m
Plug (incl.)
For up to 6 Octagon LED Modules 12V.

Art. No.:
451010



When connecting several lamps, please pay attention to the total wattage. Further transformer options can be found in the accessory range.



AQUADOWN MICRO

12~



IP67



Socket/Bulb:
G4/MR11 (excl.)
20W max.

Material:
Aluminium

Dimensions:
Cover-Ø: 9,3 cm
Lamp-H: 9,2 cm
Mounting pot-Ø/H: 12/10 cm
Supply line-L: 1,5 m

Accessory/Included parts:
Mounting pot (incl.)
Transformer (excl.)

Versions:	Art. No.:
1 slot	228301
2 slots	228302
4 slots	228304

Recommended connection:
IP44 Transformer 60VA/12V~
227160



Recommended bulb:
20W, 30°, 2700K, 450cd
533228





When connecting several lamps, please pay attention to the total wattage.
Further transformer options can be found in the accessory range.



GIMBLE OUT 90 Design by CDC

12~



350°



85°



13



13,5



9-12



0,85

IP67



Socket/Bulb:
G5,3/MR16 (excl.)
35W max.

Material:
Aluminium/glass

Dimensions:
Ø/H: 15/21 cm
Cover-Ø: 15 cm
Swivel height: 12 cm max.

Accessory/Included parts:
Mounting pot (incl.)
Transformer (excl.)

Note:
Can not be walked on!

Versions:
alu brushed

Art. No.:
228360

Recommended connection:
IP44 Transformer 60VA/12V~
227160



Recommended connection:
IP44 Transformer 150VA/12V~
227150



Recommended bulb:
35W, 38°, 2700K, 810cd
536338



Recommended bulb:
PHILIPS PowerLED 4W
36°, 3000K, 500cd
560044





N-TIC PRO MR16



Socket/Bulb:
GU5,3/MR16 (excl.)
35W max.

Material:
Stainless steel 316/glass

Dimensions:
Cover-Ø/D:
13,5/11,5 cm (round)
Cover-L/W/D:
13,5/13,5/11,5 cm (square)

Accessory/Included parts:
Mounting pot (incl.)
Transformer (excl.)

Note:
The total housing of the N-tic Pro recessed lamps is made of stainless steel cast 316 and is therefore also suitable for professional outdoor applications.

Versions:
stainless steel brushed
square cover
round cover

Art. No.:
230904
230900

Recommended bulb:
35W, 38°, 2700K, 810cd
536338



N-TIC ROUND/N-TIC SQUARE

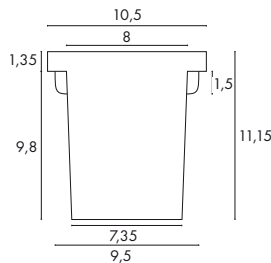

Socket/Bulb:
G5,3/MR16 (excl.)
35W max.

Material:
Aluminium

Dimensions:
Cover-Ø: 11 cm (round)
Cover-L/W: 10,5/10,5 cm (square)
Supply line-L: 2 m

Recommended bulb:
35W, 38°, 2700K, 810cd
536338



Accessory/Included parts:
Mounting pot (incl.)
Transformer (excl.)

Versions:
silver grey
N-Tic Round
N-Tic Square

Art. No.:
227450
227457

Recommended bulb:
Philips PowerLED 4W
36°, 3000K, 500cd
560044



ACCESSORY for N-tic



Stainless steel cover
for N-tic Square
Stainless steel 316
Cover-L/W: 10,5/10,5 cm

Art. No.:
227520



Satin glass
for N-tic Square and Round

Art. No.:
924036



DASAR® 115 MR16, rigid

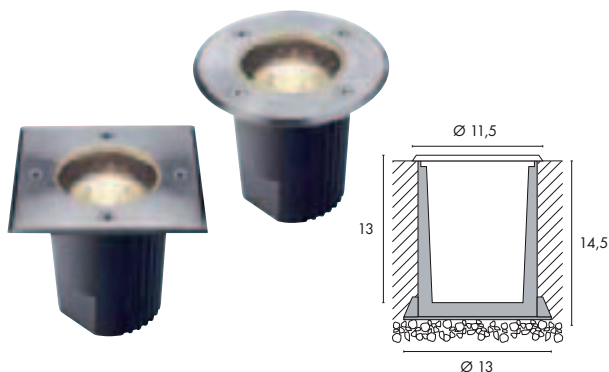

Socket/Bulb:
GU5,3/MR16 (excl.)
35W max.

Material:
Aluminium
Cover stainless steel 316

Dimensions:
Ø/H: 8/13 cm
Cover-Ø: 11,5 cm (round)
Cover-L/W: 13/13 cm (square)

Accessory/Included parts:
Mounting pot (incl.)
Transformer (excl.)

Versions:
stainless steel
round cover
square cover

Art. No.:
229340
229344

Recommended bulb:
35W, 38°, 2700K, 810cd
536338



Recommended bulb:
PHILIPS PowerLED 4W
36°, 3000K, 500cd
560044



DASAR® 115 MR16, slewable



Socket/Bulb:
GU5,3/MR16 (excl.)
35W max.

Material:
Aluminium
Cover stainless steel 316

Dimensions:
Ø/H: 8/16 cm
Cover-Ø: 13 cm (round)
Cover-L/W: 13/13 cm (square)

Accessory/Included parts:
Mounting pot (incl.)
Transformer (excl.)

Versions:
stainless steel
round cover
square cover

Art. No.:
229330
229334

Recommended bulb:
35W, 38°, 2700K, 810cd
536338



Recommended bulb:
PHILIPS PowerLED 4W
36°, 3000K, 500cd
560044



DASAR® EXACT MR16



Socket/Bulb:
GU5,3/MR16 (excl.)
35W max.

Material:
Aluminium
Cover stainless steel 316

Dimensions:
Ø/H: 11,6/16 cm (round)
L/W/H: 11,6/11,6/16,5 cm
(square)

Accessory/Included parts:
Mounting pot (incl.)
Transformer (excl.)

Note:
Dasar® Exact lamps can be
installed flush with the ground level.

Versions:
stainless steel brushed
round cover

Art. No.:
228420

square cover

228424

Recommended bulb:
35W, 38°, 2700K, 810cd
536338



ADJUST MR16



Socket/Bulb:
GU5,3/MR16 (excl.)
35W max.

Material:
Aluminium
Cover stainless steel 304

Dimensions:
Ø/H: 13,5/11,5 cm (round)
L/W/H: 13,5/13,5/11,5 cm
(square)

Accessory/Included parts:
Mounting pot (incl.)
Transformer (excl.)

Versions:
stainless steel
square cover
round cover

Art. No.:
227580
227582

Recommended bulb:
35W, 38°, 2700K, 810cd
536338





ADJUST QUADRO MR16

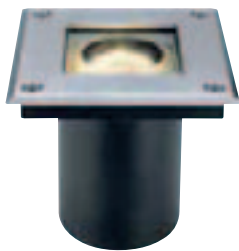

Socket/Bulb:
GU5,3/MR16 (excl.)
35W max.

Versions:
stainless steel

Art. No.:
227588

Material:
Aluminium
Cover stainless steel 304

Recommended bulb:
35W, 38°, 2700K, 810cd
536338



Dimensions:
L/W/H: 13/13/12 cm
Glass insert L/W: 7/7 cm

Accessory/Included parts:
Mounting pot (incl.)
Transformer (excl.)

RECOMMENDED TRANSFORMER for MR16 35W lamps

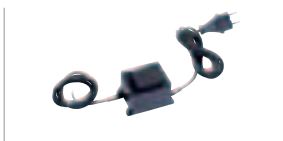

IP44 Transformer 60VA/12V~ Art. No.:
L/W/H: 6/10/6,3 cm 227160
Primary cable: 2 m,
Secondary cable: 2 m
Plug (incl.)



IP44 Transformer 150VA/12V~ Art. No.:
L/W/H: 8/11/7,5 cm 227150
Primary cable: 2 m,
Secondary cable: 2 m
Plug (incl.)

When connecting several lamps, please pay attention to the total wattage.
Further transformer options can be found in the accessory range. The transformers are splashproof according to protection class IP44, but they are not suitable for embedding or underwater use.



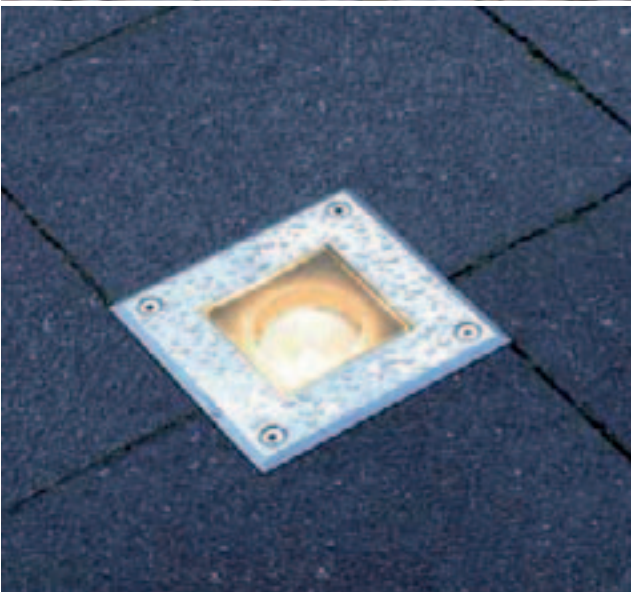

ADJUST QUADRO GU 10

230~ 12,5/12,5 12 5-10 133°C 5+ 1,1 IP67

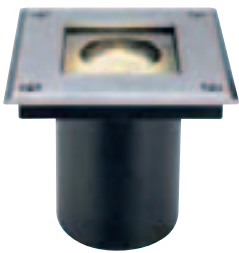

Socket/Bulb:
GU10/GU10 (excl.)
35W max.

Material:
Aluminium
Cover stainless steel 304

Dimensions:
L/W/H: 13/13/12 cm
Glass insert-L/W: 7/7 cm

Accessory/Included parts:
Mounting pot (incl.)

Versions:
stainless steel

Art. No.:
228218

Recommended bulb:
35W EnergySaver \approx 50W
20°, 2800K, 1200cd
575370



Recommended bulb:
PHILIPS LEDspot 4W
36°, 3000K, 300cd, 165lm
560084



DASAR® SQUARE GU 10

230~ 90° 30° 12,4/12,4 13,5 7-12 127°C 2+ 20J 1,15 IP67

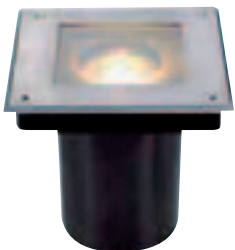

Socket/Bulb:
GU10/GU10 (excl.)
35W max.

Material:
Aluminium
Cover stainless steel 316

Dimensions:
 \varnothing /H: 7/12 cm
Cover-L/W: 13/13 cm

Accessory/Included parts:
Mounting pot (incl.)

Versions:
stainless steel

Art. No.:
229374

Recommended bulb:
35W EnergySaver \approx 50W
20°, 2800K, 1200cd
575370



Recommended bulb:
PHILIPS LEDspot 4W
36°, 3000K, 300cd, 165lm
560084





N-TIC PRO GU10

230~



Socket/Bulb:
GU10/GU10 (excl.)
35W max.

Material:
Stainless steel 316/glass

Dimensions:
Cover-Ø/D: 13,5/11,5 cm (round)
Cover-L/W/D:
13,5/13,5/11,5 cm (square)

Accessory/Included parts:
Mounting pot (incl.)

Versions:
stainless steel brushed
round cover
square cover

Art. No.:
230910
230914

Recommended bulb:
35W EnergySaver \approx 50W
20°, 2800K, 1200cd
575370



ADJUST GU10

230~



Socket/Bulb:
GU10/GU10 (excl.)
35W max.

Material:
Aluminium
Cover stainless steel 304

Dimensions:
Ø/H: 13,5/11,5 cm (round)
L/W/H: 13,5/13,5/11,5 cm (square)

Accessory/Included parts:
Mounting pot (incl.)

Versions:
stainless steel
round cover
square cover

Art. No.:
228210
228214

Recommended bulb:
35W EnergySaver \approx 50W
20°, 2800K, 1200cd
575370



DASAR® 115 GU10

230~



Socket/Bulb:
GU10/GU10 (excl.)
35W max.

Material:
Aluminium
Cover stainless steel 316

Dimensions:
Ø/H: 8/16 cm
Cover-Ø: 13 cm (round)
Cover-L/W: 13/13 cm (square)

Accessory/Included parts:
Mounting pot (incl.)

Versions:
stainless steel
round cover
square cover

Art. No.:
229320
229324

Recommended bulb:
35W EnergySaver \approx 50W
20°, 2800K, 1200cd
575370



Recommended bulb:
LEDspot 4W
36°, 3000K, 300cd, 165lm
560084



DASAR® EXACT GU10

230~

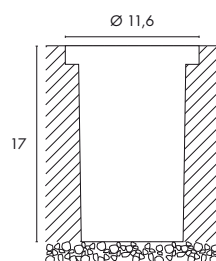

Socket/Bulb:
GU10/GU10 (excl.)
35W max.

Material:
Aluminium
Cover stainless steel 316

Dimensions:
Ø/H: 11,6/16 cm (round)
L/W/H: 11,6/11,6/16,5 cm (square)

Accessory/Included parts:
Mounting pot (incl.)

Note:
Dasar® Exact lamps can be
installed flush with the ground level.

Versions:
stainless steel brushed
round cover

Art. No.:
228430

square cover

228434

Recommended bulb:
35W EnergySaver \approx 50W
20°, 2800K, 1200cd
575370



Recommended bulb:
LEDspot 4W
36°, 3000K, 300cd, 165lm
560084





ADJUST QRB111

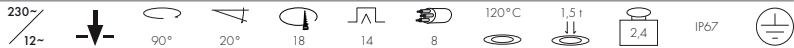

Socket/Bulb:
G53/QRB111 (excl.)
50W max.

Material:
Aluminium
Cover stainless steel 304

Dimensions:
Ø/H: 19/13,5 cm (round)
L/W/H: 19/19/13,5 cm (square)

Accessory/Included parts:
Mounting pot (incl.)
Conventional transformer (incl.)

Versions:
stainless steel
round cover
square cover

Art. No.:
227090
227092

Recommended bulb:
50W EnergySaver Æ 75W
24°, 3000K, 5800cd
545752



DASAR® ES111



Socket/Bulb:
GU10/ES111 (excl.)
75W max.

Material:
Aluminium
Cover stainless steel 316

Dimensions:
Ø/H: 21,5/16 cm (round)
L/W/H: 21,5/21,5/16 cm
(square)

Accessory/Included parts:
Mounting pot (incl.)
Diffusor insert (excl.)

Versions:
stainless steel
round cover
square cover

Art. No.:
229230
229234

Recommended bulb:
75W, 24°, 2700K, 2000cd
575672



Recommended accessory:
Diffusor insert
Product-Ø: 14 cm
Angle of radiation: 50°
229240







DASAR® 260 UNI

230~



Socket/Bulb:
E27/EnergySaver (excl.)
up to max. Ø/L: 5,2/17,3 cm
24W max.

Material:
Aluminium
Cover stainless steel 316

Dimensions:
Ø/H: 27/31,5 cm (round)
L/W/H: 27/27/31,5 cm (square)

Accessory/Included parts:
Mounting pot (incl.)

Recommended accessory:

Diffusor insert
Product Ø: 19 cm
Angle of radiation: 50°
229241



Versions:
stainless steel
round cover
square cover

Art. No.:
229210
229214

Recommended bulb:
20W, 2700K, 1200lm, EEK=A
508760



DASAR® 215 UNI

230~



Socket/Bulb:
E27/EnergySaver (excl.)
up to max. Ø/L: 4,5/13,4 cm
11W max.
or PAR30, 75W max. (excl.)
or PAR38, 80W max. (excl.)

Material:
Aluminium
Cover stainless steel 316

Dimensions:
Ø/H: 21,5/22,5 cm (round)
L/W/H: 21,5/21,5/22,5 cm
(square)

Accessory/Included parts:
Mounting pot (incl.)
Diffusor insert (excl.)

*** Surface temperature:**
EnergySaver = 48 °C
PAR30 = 119 °C
PAR38 = 108 °C

Recommended accessory:

Diffusor insert
Product Ø: 14 cm
Angle of radiation: 50°
229240



Versions:
stainless steel
round cover
square cover

Art. No.:
229200
229204

Recommended bulb:
11W, 2700K, 580lm, EEK=A
508211



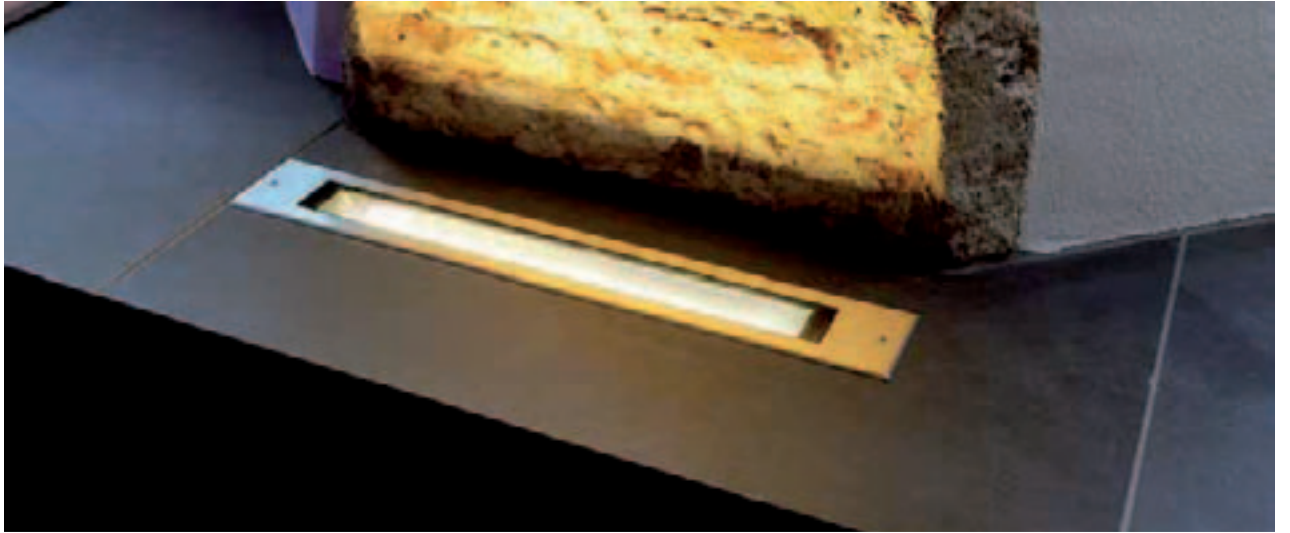

DASAR® T5-14

230~

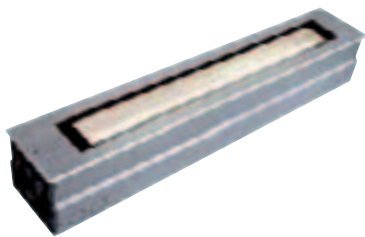

Socket/Bulb:
G5/T5 EnergySaver (excl.)
14W

Material:
Aluminium/stainless steel 316

Dimensions:
L/W/H: 70/12/9,7 cm
Cover-L/W: 70/12 cm

Accessory/Included parts:
Installation profile (incl.)
Electronic ballast (incl.)

Versions:
stainless steel

Art. No.:
230100

Recommended bulb:
14W, 3000K, 1230lm
548014

(PU see page 661)

DASAR® T5-21

230~

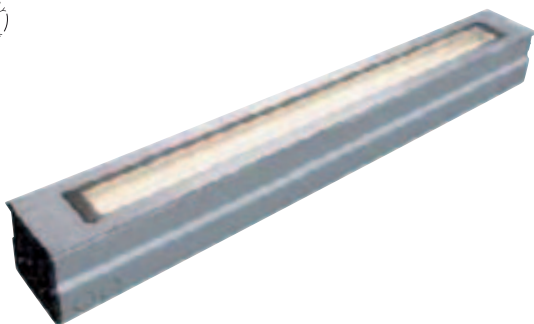

Socket/Bulb:
G5/T5 EnergySaver (excl.)
21W

Material:
Aluminium/stainless steel 316

Dimensions:
L/W/H: 100/12/9,7 cm
Cover-L/W: 100/12 cm

Accessory/Included parts:
Installation profile (incl.)
Electronic ballast (incl.)

Versions:
stainless steel

Art. No.:
230110

Recommended bulb:
21W, 3000K, 1910lm
548021

(PU see page 661)

DASAR® GX10 Design by CDC

230~

HiEFFICIENT
PROFIlight.**Socket/Bulb:**
GX10/CMH-MR16 (excl.)
20W**Material:**
Aluminium
Cover stainless steel 316**Dimensions:**
Ø/H: 18/18 cm (round)
L/W/H: 18/18/18 cm (square)**Accessory/Included parts:**
Electronic ballast (incl.)
Mounting pot (incl.)**Versions:**
stainless steel
round cover
square cover**Art. No.:**
230140
230144**Recommended bulb:**
20W, 40°, 3000K, 1500cd
507240

ADJUST HQI 70

230~

HiEFFICIENT
PROFIlight.**Socket/Bulb:**
G12/HQI-T; CDM-T (excl.)
70W**Material:**
Aluminium
Cover stainless steel 304**Dimensions:**
Ø/H: 26,5/20 cm (round)
L/W/H: 26,5/26,5/20 cm
(square)**Accessory/Included parts:**
Mounting pot (incl.)
Conventional ballast (incl.)**Versions:**
stainless steel
round cover
square cover**Art. No.:**
228240
228244**Recommended bulb:**
70W, 3000K, 6600lm
507130**Recommended bulb:**
70W, 3000K, 7300lm
507430

DASAR® HIT-T 70W

230~

HiEFFICIENT
PROFIlight.**Socket/Bulb:**
G12/HQI-T; CDM-T (excl.)
70W**Material:**
Aluminium
Cover stainless steel 316**Dimensions:**
Ø/H: 26/30 cm (round)
L/W/H: 27/27/32 cm (square)**Accessory/Included parts:**
Mounting pot (incl.)
Conventional ballast (incl.)**Versions:**
stainless steel
round cover
square cover**Art. No.:**
229270
229274**Recommended bulb:**
70W, 3000K, 6600lm
507130**Recommended bulb:**
70W, 3000K, 7300lm
507430

DASAR® HIT-T 150W

230~

HiEFFICIENT
PROFIlight.**Socket/Bulb:**
G12/HQI-T; CDM-T (excl.)
150W**Material:**
Aluminium
Cover stainless steel 316**Dimensions:**
Ø/H: 26/30 cm (round)
L/W/H: 27/27/32 cm (square)**Accessory/Included parts:**
Mounting pot (incl.)
Conventional ballast (incl.)**Versions:**
stainless steel
round cover
square cover**Art. No.:**
229280
229284**Recommended bulb:**
150W, 3000K, 14000lm
507140**Recommended bulb:**
150W, 3000K, 15000lm
507440



DASAR® HQI SQUARE 70W asymmetrical 230~



HiEFFICIENT
PROFIlight.



Socket/Bulb:
Rx7s/HQI-TS; CDM-TS (excl.)
70W

Versions:
stainless steel

Art. No.:
229294



Material:
Aluminium
Cover stainless steel 316

Recommended bulb:
70W, 4200K, 6000lm
507071



Dimensions:
L/W/H: 25,5/25,5/15,5 cm

Accessory/Included parts:
Mounting pot (incl.)
Conventional ballast (incl.)

Note:
Asymmetric reflector.

DASAR® HIT-DE 150W Asym. 230~



HiEFFICIENT
PROFIlight.



Socket/Bulb:
Rx7s/HQI-TS; CDM-TS (excl.)
150W

Versions:
stainless steel
round cover
square cover

Art. No.:
229300
229304



Material:
Aluminium
Cover stainless steel 316

Recommended bulb:
150W, 4200K, 14200lm
507151













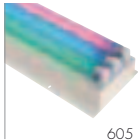



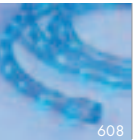
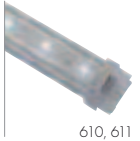

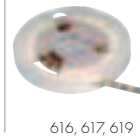
Dimensions:
Ø/H: 26/30 cm (round)
L/W/H: 27/27/32 cm (square)

Accessory/Included parts:
Mounting pot (incl.)
Conventional ballast (incl.)

Note:
Asymmetric reflector.

DECORATIVE LIGHT, LIGHT BARS & LED-STRIPS

Due to production-related reasons the light colour of LEDs can vary amongst each other. The value for light colour and lumen, as far as they are mentioned, are typical average values. We do our best to deliver every shipment with the same colour selection. However by follow-up orders we cannot guarantee the same light colour. Detailed technical data sheets to the topic LED strips can be obtained on request.

LIM® - Light In Motion Decorative light	 605	 607	 607	 606	 608				
Light bars Single colour	 610, 611	Light bars RGB	 611						
Flexible Strips Single colour	 616, 617, 619	Flexible Strips RGB	 622	Flexible Strips with IP Single colour	 621, 626, 627	Flexible Strips with IP RGB	 624		
Rigid strips Single colour	 613, 614	Rigid strips RGB	 615	Rigid strips with IP Single colour	 628				
Profiles for LED Strips	 625	 625	 626						



Extraordinary atmosphere by coloured light realization with the multicolour lighting bank and light modules of the LIM®-light systems. Additive colour mixture with six colour fluorescent bulbs makes the simulation of various colour situations possible, from the neutral colour of daylight up to all spectral colours of light. Even finest pastel shades in exceptionally homogeneous light distribution are no problem. The LIM® lighting technology offers various application possibilities to you: in sales and presentation areas the light attraction of colour changing luminous ceilings and light banks provide a special attention. In business areas you can control the quantity of light, colour of light and light balance of whole office wings. In the reception or hotel area as well as in the catering trade you can create a stylish atmosphere with LIM® light elements. In medical practices and hospitals the LIM® light system makes special lighting solutions possible depending upon desire either more functionally or more decoratively.

With a master unit a max. of 200 RGB Slave-Light-Banks can be controlled. With the installation of the light bank a maximum usage of the electrical circuit must be adhered to (per 16 ampere electric circuit up to 30 RGBSlave-Light banks). The LIM®2 RGB control console enables together with the RGB master light banks and/or RGB master light module the control and the calling up of light colour and light level by a key stroke. 4 light scenes can be pre-programmed and called up by a key stroke. Also dynamic sequences of the programmed light scenes are possible due to selectable stationary and change-over times. 4 different sequencing programs with 8 light scenes each are already stored in the system. Further features are panic circuit, external switching entry and variable time intervals. A comfortable system, which does not require prior knowledge of the system. It can also be used by end users without problem.

LIM® RGB MASTER LIGHT MODULE 3x 36W Design by CDC

230~

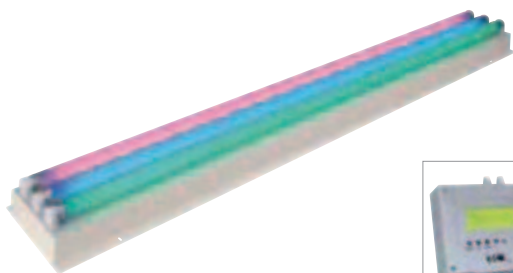

Socket/Bulb:
G13/T8 (incl.)
je 1x red, green, blue
3x 36W

Material:
Stahl

Dimensions:
L/W/D: 123/19/9 cm

Accessory/Included parts:
3 Electronic ballasts (incl.)
LIM®2 controller (incl.)

Versions: Art. No.:
Master module **with** integrated
signal converter 1-10V and
control console ▼ 158020

Slave module **without** signal
converter, for control
voltage 1-10V ▼ 158021

Multicolor-lightmodules with particularly homogenous light emission for the universal application in light walls through simple surface fitting and lighting up a diffuser wall mounted at a distance. According to application this distance can vary between 20 cm or more. The applied bulbs must be from the same manufacturer and be burned-in for 100 hours at full 100% brightness to guarantee a equal colour distribution and quality. A data sheet can be sent on request.



LED MULTIFUNCTION-MODULE

24~



IP65

LED
LEDTEC

Bulb:
LED SMD (incl.)
0,7W per module

Material:
Polycarbonate transparent

Dimensions:
Module-L/W/H: 8/1,5/2,4 cm.
20 cm cable at each side.
Min. material thickness: 1 mm
Max. material thickness: 10 mm
Optimal tube-Ø: 40-80 mm.

Note:
In outdoor areas and all other areas where the installation could become moist, please seal all connections with a shrink tube. May only be screwed together with safety torx tool (T10). Operate only with conventional transformer.
Maximum load:
20 modules = 20VA-Transformer,
60 modules = 60VA-Transformer

Accessory/Included parts:
Power unit/Transformer (excl.)

Versions:
LED white
LED warm white

Art. No.:
234001
234002

Recommended connection:
LED power unit
12VA, 12V=
470545



ACCESSORY for LED Multifunction-Module



Feed-in
2 m, 60W max.

Art. No.:
234010

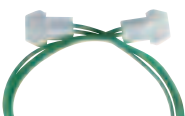

Connector
20 cm, 60W max
50 cm, 60W max

Art. No.:
234011
234012

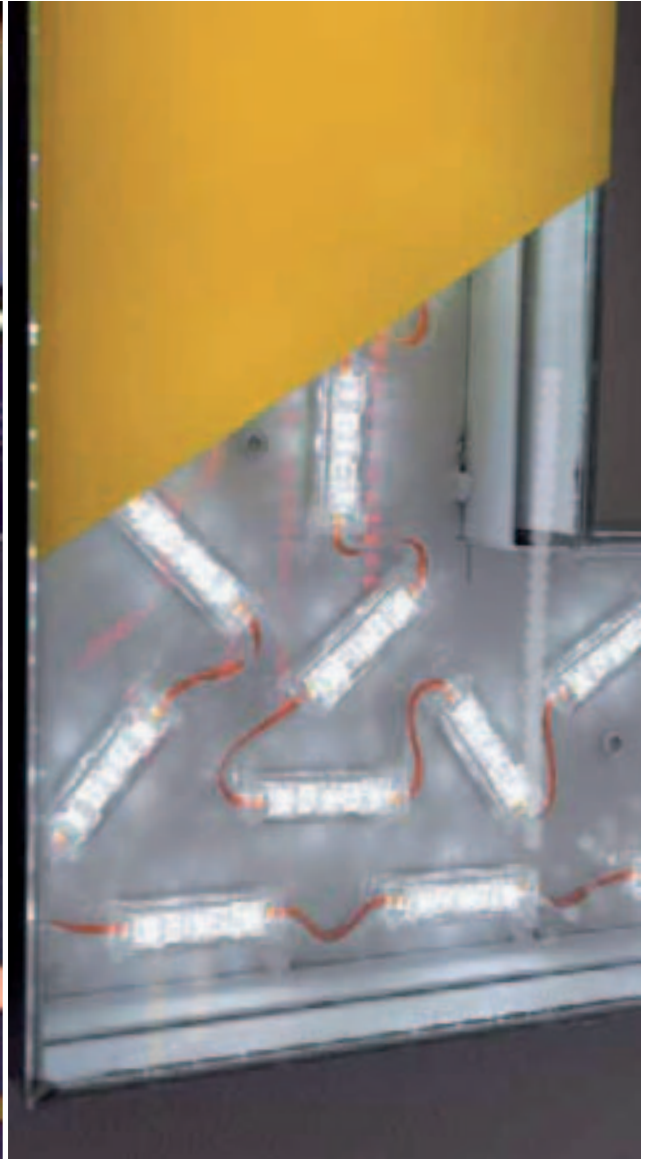
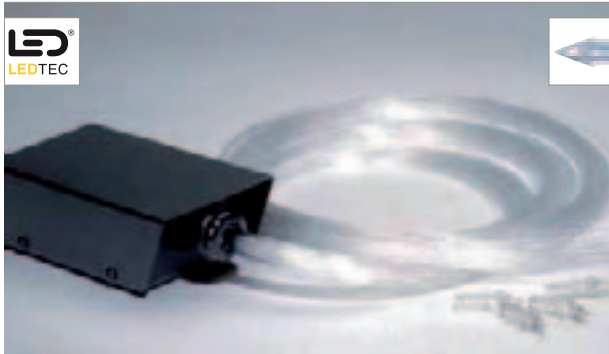

LEDI LIGHT® FIBER SET LED

Bulb:
PowerLED (incl.)
6,3 W

Dimensions:
L/W/H: 14,5/7,5/5 cm
Core-L/Ø: ca. 200/0,007 cm
End caps-L/Ø: 3,3/1 cm
Supply line-L: 1,5 m

Accessory/Included parts:
80 end caps (incl.)
Transformer (incl.)
Mains plug (incl.)

Versions:
LED white ▼

Art. No.:
631100

80 approx. 2 m fibre cores which are fed in via a 4 channel fibre generator based on LED technique with which the necessary luminous intensity is supplied. Can also be used without caps. Installation dimensions for the use with caps. Adapter: prim.: 230V/50HZ, sec.: 6V/250HZ

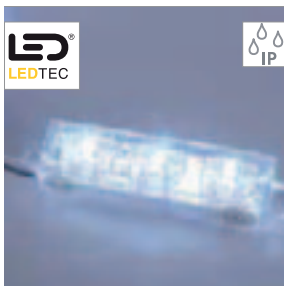
MINI LED MODULE CAIN

Bulb:
SuperFlux LED (incl.)
6W per chain

Material:
PC/artificial resin

Dimensions:
Module-L/W/H: 5,4/1,3/0,9 cm
Module distance: 3,8 cm
Chain-L: 2 m
Supply line-L: 0,3 m

Note:
25 modules with each 3 LEDs.
Separable after every module.
Max. 4 chains can be connected consecutively.

Accessory/Included parts:
Power unit (excl.)

Versions:
LED white

Art. No.:
550401

Recommended connection:
LED power unit 12W, 12V=
470507



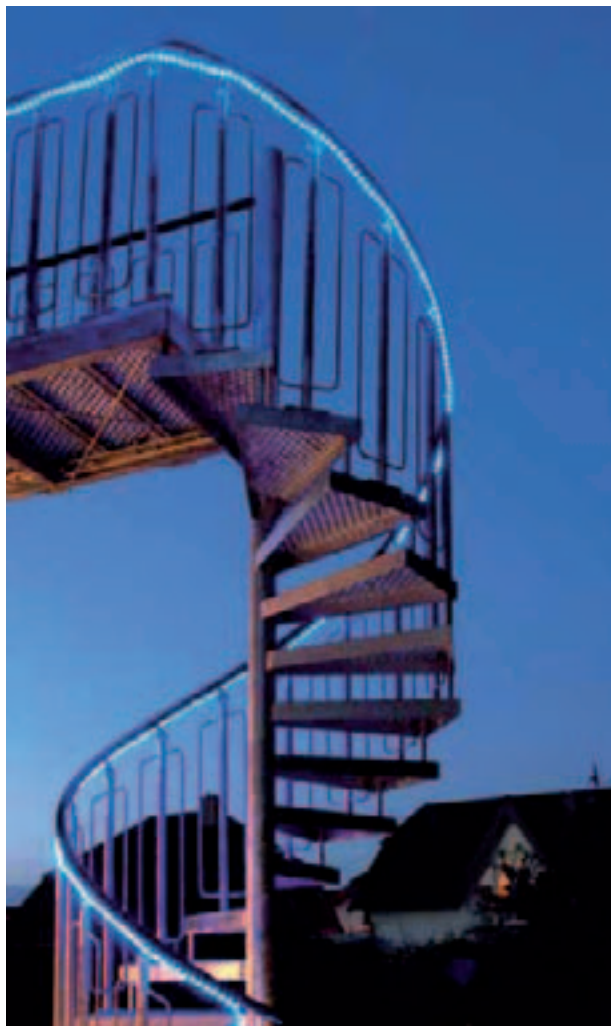

LED PENLIGHT® PRO 230V

230~ IP44

Accessory/Included parts:
 Feed-in set (incl.)
 Rectifier (incl.)
 Mains plug (incl.)

Note:
 Mains cable-L: 1,5 m

Article No.	Description	LED colour	Voltage in AC	Leistung in W/m	LED distance in cm	LEDs per strip	LEDs per 1,5 m	Ø in cm	Length in m	Separability in m	Weight in kg	Price
232711	LED PenLight® PRO 10,5	white	230V	4,6/1,5	2,77	378	54	1,3	10,5	every 1,5	2,08	
232712	LED PenLight® PRO 10,5	warm white	230V	4,6/1,5	2,77	378	54	1,3	10,5	every 1,5	2,08	
232717	LED PenLight® PRO 10,5	blue	230V	4,6/1,5	2,77	378	54	1,3	10,5	every 1,5	2,08	
232741	LED PenLight® PRO 40,5	white	230V	4,6/1,5	2,77	1458	54	1,3	40,5	every 1,5	6,4	
232742	LED PenLight® PRO 40,5	warm white	230V	4,6/1,5	2,77	1458	54	1,3	40,5	every 1,5	6,4	
232747	LED PenLight® PRO 40,5	blue	230V	4,6/1,5	2,77	1458	54	1,3	40,5	every 1,5	6,4	

ACCESSORY for LED PenLight® Pro

<p>Track 1 pce. Track-L: 1 m 232661</p> 	<p>End cap 1 pce. IP44 after sticking with Turbo adhesive 100 (232600). 232691</p> 	<p>Fastening clips 100 pce. 232651</p> 	<p>Gutter clips 10 pce. 232681</p> 
<p>Feed-in set for LED PenLight® Pro IP44 after sticking with Turbo adhesive 100. End cap, mains plug, rectifier, Turbo adhesive 100 (incl.) 232700</p> 	<p>Longitudinal connector 1 pce. IP44 after sticking with vinegar-free silicone. 232641</p> 	<p>Turbo adhesive 100 232600</p> 	





LED
LEDTEC



PADI LED 600 Light bar

24V



120°



Bulb:
LED (incl.)



Material:
Aluminium anodized/PC

Dimensions:
Supply line-L: 1,5 m

Accessory/Included parts:
3 mounting brackets (incl.)
Power unit (excl.)

Note:
When connecting several light bars,
please pay attention to the total
wattage!
Further power units can be found in
the accessory range

Recommended connection:
LED power unit 12W, 24V=
470502



Recommended connection:
LED power unit, 100W, 24V=
470540 dimmable

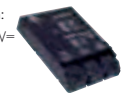

Article No.	Description	LED colour	Voltage in DC	Power in W	LED distance in cm	LEDs per bar	Length in cm	Width in cm	Height in cm	Operating life in h	Price
111731	Padi LED 600 Light bar	white	24V	4	1,0	48	60,6	1,6	0,8	20000	
111732	Padi LED 600 Light bar	warm white	24V	4	1,0	48	60,6	1,6	0,8	20000	



DELFC PRO Light bar



Bulb:
SMD LED (incl.)

Material:
Aluminium anodized/plastic

Accessory/Included parts:
Power unit (excl.)

Note:
Directly connectable via wrap connections.
By an output of >50W a new feed-in must be made!
When connecting several light bars, please pay attention to the total wattage!
Further power units can be found in the accessory range.

Recommended connection:
LED power unit 12W, 24V= 470502

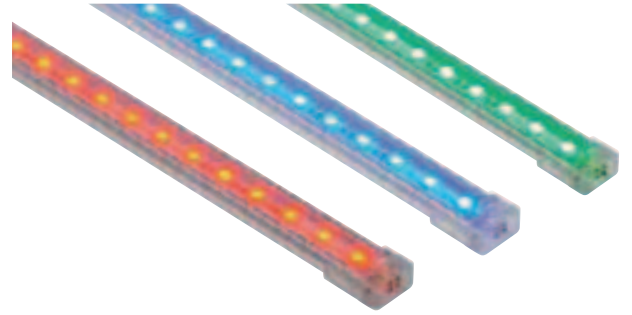

DELFC PRO Light bar RGB



Bulb:
3in 1 SMD LED (incl.)

Material:
Aluminium anodized/plastic

Accessory/Included parts:
Power unit (excl.)
Controller (excl.)

Note:
Directly connectable via wrap connections.
By an output of >50W a new feed-in must be made!
When connecting several light bars, please pay attention to the total wattage!
Further controllers can be found in the accessory range.

Recommended connection:
Power LIM®2 RGB
Master controller 24V= 470581

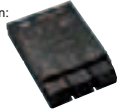

Recommended connection:
Power LIM®2 RGB
Slave controller 24V= 470582

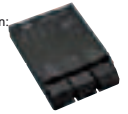

Recommended accessory:
Remote control for Master controller 470520

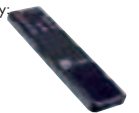

DELFC PRO



Article No.	Description	LED colour	Voltage in DC	Power in W	LED distance in cm	LEDs per bar	Length in cm	Width in cm	Height in cm	Operating life in h	Weight in kg	Price
631451	Delf C 500 Pro	white	24V	4,9	1,1	30	50,0	2,0	1,5	20000	0,12	
631452	Delf C 500 Pro	warm white	24V	4,9	1,1	30	50,0	2,0	1,5	20000	0,12	
631461	Delf C 1000 Pro	white	24V	11,6	1,1	60	100,0	2,0	1,5	20000	0,23	
631462	Delf C 1000 Pro	warm white	24V	11,6	1,1	60	100,0	2,0	1,5	20000	0,23	
631453	Delf C 500 RGB Pro	RGB	24V	7,5	1,1	30	50,0	2,0	1,5	20000	0,12	
631463	Delf C 1000 RGB Pro	RGB	24V	14,6	1,1	60	100,0	2,0	1,5	20000	0,23	

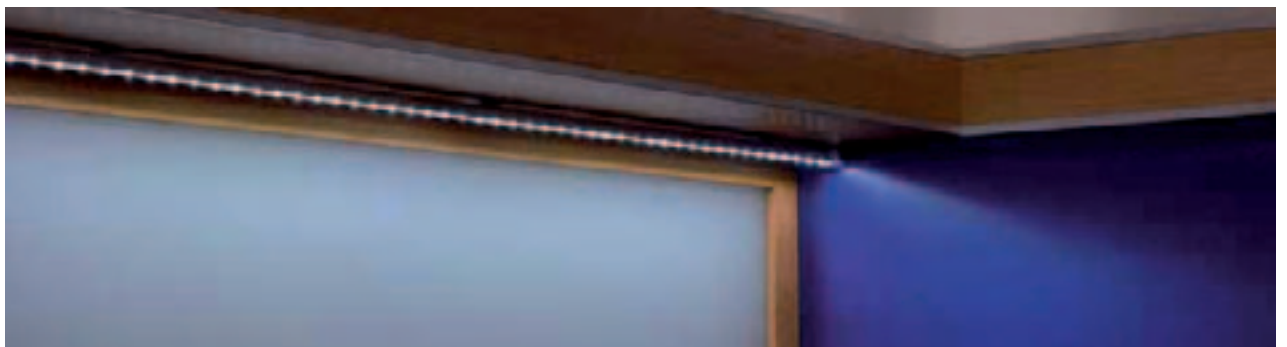

ACCESSORY for DELFC Pro Light bar single colour

Feed-in cable
50W max.
Cable-L: 1,5 m
631470



Flexible connector
50W max.
Cable-L: 12 cm
631471



Mounting clips
10 pce.
631472

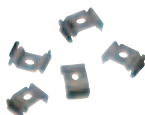

ACCESSORY for DELFC Pro Light bar RGB

Feed-in cable
50W max.
Cable-L: 1,5 m
631473



Flexible connector
50W max.
Cable-L: 12 cm
631474



Mounting clips
10 pce.
631472







LED-STRIPS 12V=



Bulb:
SMD LED (incl.)

Accessory/Included parts:
Power unit (excl.)

Note:
Directly connectable via wrap connections. After separation a through-wiring is only possible via soldering. By an output of >25W a new feed-in must be made!

Recommended connection:
LED power unit, 12W, 12V=
470507

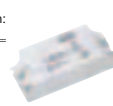

Recommended connection:
LED power unit, 60W, 12V=
470508

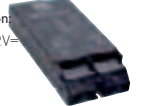

ACCESSORY for LED-Strip 12V=

Feed-in cable, 25W max., 2 pce.
Cable-L: 50 cm
550650



Article No.	Description	LED colour	Voltage in DC	Power in W	LED distance in cm	LEDs per strip	LEDs per m	Length in cm	Width in cm	Height in cm	Operating life in h	Separability in cm	Price
550641	LED strip	white	12V	2,3	1,2	30	62	48,5	0,8	0,6	20000	every 4,7	
550642	LED strip	warm white	12V	2,3	1,2	30	62	48,5	0,8	0,6	20000	every 4,7	

Detailed technical data sheets to the topic LED strips can be obtained on request!



DAYLIGHT LED-STRIP 24V=

24V=



Bulb:
SMD LED (incl.)

Accessory/Included parts:
Power unit (excl.)
Direct connector (incl.)

Note:
Equipped with 10 white und 20 warm white LEDs.
Not suitable for a mounting track!
By an output of >50W a new feed-in must be made!

Recommended connection:

Power LIM®2 RGB
Slave controller 24V=
470582

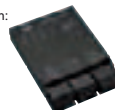

Recommended connection:

Remote control for
Master controller
470520



Recommended connection:

Power LIM®2 RGB
Master controller 24V=
470581

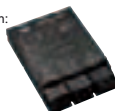

Article No.	Description	LED colour	Voltage in DC	Power in W	LED distance in cm	LEDs per strip	LEDs per m	Length in cm	Width in cm	Height in cm	Operating life in h	Price
550260 ▼	Daylight LED-Strip	white/warm white	24V	3	2,5	30	111	26,5	1,4	0,9	20000	

ACCESSORY for Daylight LED-Strip

Feed-in cable
Cable-L: 0,5 m
550261 ▼



Flex-Connector, 10 pce.
Cable-L: 5 cm
550262 ▼



Fastening clips, 100 pce.
550191



LED-STRIPS 24V=

24V=



Bulb:
LED (incl.)

Accessory/Included parts:
Power unit (excl.)

Note:
When connecting several strips, please pay attention to the total wattage! Further power units can be found in the accessory range.
By an output of >50W a new feed-in must be made.

Recommended connection:

LED wall power supply 16W, 24V=
Cable-L: 2 m
470571



Article No.	Description	LED colour	Voltage in DC	Power in W	LED distance in cm	LEDs per strip	LEDs per m	Length in cm	Width in cm	Height in cm	Operating life in h	Separability in cm	Weight in kg	Price
550181	LED strip	white	24V	2,0	1,3	24	78	30,5	0,7	0,7	20000	every 7,6	0,03	
550182	LED strip	warm white	24V	2,0	1,3	24	78	30,5	0,7	0,7	20000	every 7,6	0,03	
550187	LED strip	blue	24V	2,0	1,3	24	78	30,5	0,7	0,7	20000	every 7,6	0,03	

ACCESSORY for LED-strips single colour

Feed-in cable 2 pce.
50W max.
Cable-L: 50 cm
550192



Connector plug 10 pce.
50W max.
Cable-L: 10 cm
550190



Direct connector 10 pce.
50W max.
550193



Fastening clips, 100 pce.
550191



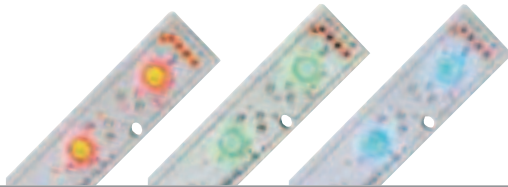

LED-STRIP RGB 3in1 24V=



Bulb:
LED (incl.)

Accessory/Included parts:
Power unit (excl.)
Controller (excl.)
Direct connector (incl.)

Note:
By an output of >50W a new feed-in must be made!

Recommended connection:
Power LIM®2 RGB
Master controller 24V=
470581

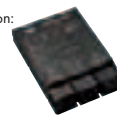

Recommended accessory:
Remote control for
Master controller
470520



Recommended connection:
Power LIM®2 RGB
Slave controller 24V=
470582

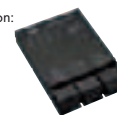

Article No.	Description	LED colour	Voltage in DC	Power in W	LED distance in cm	LEDs per strip	LEDs per m	Length in cm	Width in cm	Height in cm	Weight in kg	Price
550790	RGB LED strip	RGB	24V	3	2,5	10	40	25,0	1,6	0,7	0,02	

ACCESSORY für RGB LED-strips

Flex-Connector 10 pce.
50W max.
550792



Feed-in cable
50W max.
550791



Mounting track
Track-L: 100 cm
220631

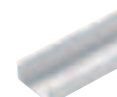

Fastening clips, 100 pce.
550191





LED
LEDTEC



FLEXLED ROLL 12V~



Bulb:
LED (incl.)

Accessory/Included parts:
Rectifier (incl.)
Conventional transformer (excl.)
Rear side equipped with adhesive tape.

Note:
Min. bending radius: 1,3 cm.
ta max. +40°C.
Connection of single Flex-strips via soldering or direct connector.

From a length of 5,1 m a new feed-in must be made!
Suitable for PC tube (211200).
Supply line-L: 30 cm.
Operate only with conventional transformer!

Recommended connection:
IP44 C-transformer,
10VA, 12V~
451010



Article No.	Description	LED colour	Voltage in AC	Power in W	LED distance in cm	LEDs per strip	LEDs per m	Length in m	Width in cm	Height in cm	Operating life in h	Separability in cm	Weight in kg	Price
552031	FlexLED Roll	white	12V	2,9	2,50	36	40	0,9	0,7	0,3	20000	every 15	0,01	
552032	FlexLED Roll	warm white	12V	2,9	2,50	36	40	0,9	0,7	0,3	20000	every 15	0,01	
552041	FlexLED Roll	white	12V	9,6	2,50	120	40	3,0	0,7	0,3	20000	every 15	0,03	
552042	FlexLED Roll	warm white	12V	9,6	2,50	120	40	3,0	0,7	0,3	20000	every 15	0,03	
552051	FlexLED Roll	white	12V	16,5	2,50	200	40	5,1	0,7	0,3	20000	every 15	0,05	
552052	FlexLED Roll	warm white	12V	16,5	2,50	200	40	5,1	0,7	0,3	20000	every 15	0,05	

When connecting several strips, please pay attention to the total wattage! Further transformers can be found in the accessory range.

LED
LEDTEC



FLEXLED ROLL 12V=



Bulb:
LED (incl.)

Accessory/Included parts:
Supply line (excl.)
Power unit (excl.)
Rear side equipped with adhesive tape.

Note:
Min. bending radius: 1,3 cm.
ta max. +40°C.
Connection of single Flex-strips via soldering or direct connector.
From a length of 5 m a new feed-in must be made!
Not suitable for PC tube!

Recommended connection:
LED power unit, 12W, 12V=
470507



Article No.	Description	LED colour	Voltage in DC	Power in W	LED distance in cm	LEDs per strip	LEDs per m	Length in m	Width in cm	Height in cm	Operating life in h	Separability in cm	Weight in kg	Price
552001	FlexLED Roll	white	12V	4	1,65	60	60	1,0	0,8	0,24	20000	every 5	0,02	
552002	FlexLED Roll	warm white	12V	4	1,65	60	60	1,0	0,8	0,24	20000	every 5	0,02	
552007	FlexLED Roll	blue	12V	4	1,65	60	60	1,0	0,8	0,24	20000	every 5	0,02	
552011	FlexLED Roll	white	12V	12	1,65	180	60	3,0	0,8	0,24	20000	every 5	0,05	
552012	FlexLED Roll	warm white	12V	12	1,65	180	60	3,0	0,8	0,24	20000	every 5	0,05	
552017	FlexLED Roll	blue	12V	12	1,65	180	60	3,0	0,8	0,24	20000	every 5	0,05	
552021	FlexLED Roll	white	12V	20	1,65	300	60	5,0	0,8	0,24	20000	every 5	0,09	
552022	FlexLED Roll	warm white	12V	20	1,65	300	60	5,0	0,8	0,24	20000	every 5	0,09	
552027	FlexLED Roll	blue	12V	20	1,65	300	60	5,0	0,8	0,24	20000	every 5	0,09	

When connecting several strips, please pay attention to the total wattage! Further power units can be found in the accessory range.

ACCESSORY for FlexLED Roll single colour 12V~ and 12V=

Feed-in with 30 cm cable
up to 8 mm
550412



Direct connector, 2 pce.
up to 8 mm
550415



90° Solder edges, 2 pce.
2A max.
550570



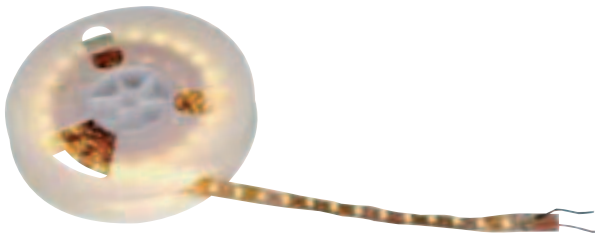

FLEXLED ROLL 24V=



Bulb:
LED (incl.)

Accessory/Included parts:
Supply line (excl.)
Power unit (excl.)
Rear side equipped with adhesive tape.

Note:
Min. bending radius: 1,3 cm.
ta max.+40°C.
Connection of single Flex-strips via soldering or direct connector.
From a length of 5 m a new feed-in must be made!

Recommended connection:
LED power unit 12W, 24V=
470502



Article No.	Description	LED colour	Voltage in DC	Power in W	LED distance in cm	LEDs per strip	LEDs per m	Length in m	Width in cm	Height in cm	Operating life in h	Separability in cm	Weight in kg	Price
552101	FlexLED Roll	white	24V	5	1,70	60	60	1,0	1,0	0,30	20000	every 10	0,02	
552102	FlexLED Roll	warm white	24V	5	1,70	60	60	1,0	1,0	0,30	20000	every 10	0,02	
552107	FlexLED Roll	blue	24V	5	1,70	60	60	1,0	1,0	0,30	20000	every 10	0,02	
552111	FlexLED Roll	white	24V	15	1,70	180	60	3,0	1,0	0,30	20000	every 10	0,05	
552112	FlexLED Roll	warm white	24V	15	1,70	180	60	3,0	1,0	0,30	20000	every 10	0,05	
552117	FlexLED Roll	blue	24V	15	1,70	180	60	3,0	1,0	0,30	20000	every 10	0,05	
552121	FlexLED Roll	white	24V	25	1,70	300	60	5,0	1,0	0,30	20000	every 10	0,09	
552122	FlexLED Roll	warm white	24V	25	1,70	300	60	5,0	1,0	0,30	20000	every 10	0,09	
552127	FlexLED Roll	blue	24V	25	1,70	300	60	5,0	1,0	0,30	20000	every 10	0,09	

When connecting several strips, please pay attention to the total wattage! Further power units can be found in the accessory range.

ACCESSORY for FlexLED Roll 24=

Feed-in with 30 cm cable
up to 10 mm
550413



Direct connector 2 pce.
up to 10 mm
550416



90° solder edges, 2 pce.
2A max.
550570



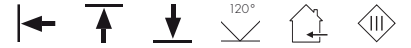

FLEXLED ROLL PRO 12V=

Bulb:
LED (incl.)

Accessory/Included parts:
Supply line (excl.)
Power unit (excl.)
Rear side equipped with adhesive tape.

Note:
Min. bending radius: 1,3 cm
to max.+40°C
Connection of single Flex-strips via soldering or direct connector.
From a length of 3 m a new feed-in must be made!

Recommended connection:
LED power unit, 12V, 12V=
470507



Article No.	Description	LED colour	Voltage in DC	Power in W	LED distance in cm	LEDs per strip	LEDs per m	Length in m	Width in cm	Height in cm	Operating life in h	Separability in cm	Weight in kg	Price
552061	FlexLED Roll Pro	white	12V	10	1,7	60	60	1,0	1,0	0,22	20000	every 5	0,04	
552062	FlexLED Roll Pro	warm white	12V	10	1,7	60	60	1,0	1,0	0,22	20000	every 5	0,04	
552071	FlexLED Roll Pro	white	12V	30	1,7	180	60	3,0	1,0	0,22	20000	every 5	0,13	
552072	FlexLED Roll Pro	warm white	12V	30	1,7	180	60	3,0	1,0	0,22	20000	every 5	0,13	

FlexLED Roll Pro has 3 chips in one LED and consequently of a higher luminous flux.

When connecting several strips, please pay attention to the total wattage! Further power units can be found in the accessory range.

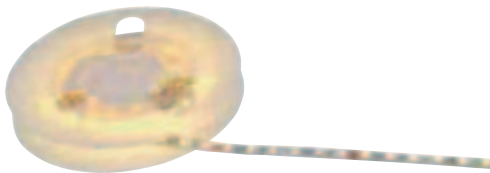

FLEXLED ROLL PRO 24V=

Bulb:
LED (incl.)

Accessory/Included parts:
Supply line (excl.)
Power unit (excl.)
Rear side equipped with adhesive tape.

Note:
Min. bending radius: 1,3 cm
to max.+40°C
Connection of single Flex-strips via soldering or direct connector.
From a length of 3 m a new feed-in must be made!

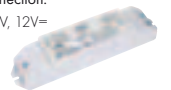
Recommended connection:
LED power unit, 12V, 12V=
470507



Article No.	Description	LED colour	Voltage in DC	Power in W	LED distance in cm	LEDs per strip	LEDs per m	Length in m	Width in cm	Height in cm	Operating life in h	Separability in cm	Weight in kg	Price
552131	FlexLED Roll Pro	white	24V	13,3	1,7	60	60	1,0	1,0	0,22	20000	every 10	0,04	
552132	FlexLED Roll Pro	warm white	24V	13,3	1,7	60	60	1,0	1,0	0,22	20000	every 10	0,04	
552141	FlexLED Roll Pro	white	24V	40	1,7	180	60	3,0	1,0	0,22	20000	every 10	0,13	
552142	FlexLED Roll Pro	warm white	24V	40	1,7	180	60	3,0	1,0	0,22	20000	every 10	0,13	

FlexLED Roll Pro has 3 chips in one LED and consequently of a higher luminous flux.

When connecting several strips, please pay attention to the total wattage! Further power units can be found in the accessory range.

ACCESSORY for FlexLED Roll Pro 12V= and 24V=

Feed-in with 30 cm cable
up to 10 mm
550413



Direct connector 2 pce.
up to 10 mm
550416



90° solder edges, 2 pce.
2A max.
550570





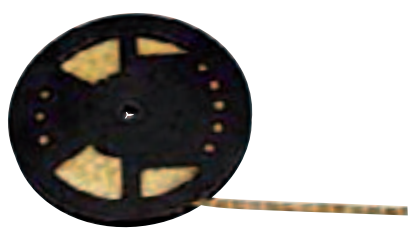

IP FLEXLED ROLL 12V=

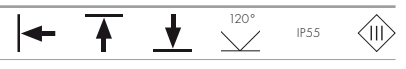

Bulb:
LED (incl.)

Accessory/Included parts:
Power unit (excl.)
Rear side equipped with adhesive tape.

Note:
Supply line-L: 50 cm.
Strip embedded in plastic.
Min. bending radius: 3,75 cm.
to max. -30°C up to +40°C
Not extendable.
From a length of 5 m a new feed-in must be made!

Recommended connection:
LED power unit, 12W, 12V=
470507



Article No.	Description	Colour	Voltage in DC	Power in W	LED distance in cm	LEDs per strip	LEDs per m	Length in m	Width in cm	Height in cm	Operating life in h	Separability in cm	Weight in kg	Price
552211	IP FlexLED Roll	white	12V	12	1,65	180	60	3,0	1,0	0,5	20000	every 5	0,20	
552212	IP FlexLED Roll	warm white	12V	12	1,65	180	60	3,0	1,0	0,5	20000	every 5	0,20	
552221	IP FlexLED Roll	white	12V	20	1,65	300	60	5,0	1,0	0,5	20000	every 5	0,33	
552222	IP FlexLED Roll	warm white	12V	20	1,65	300	60	5,0	1,0	0,5	20000	every 5	0,33	

When connecting several strips, please pay attention to the total wattage! Further power units can be found in the accessory range.

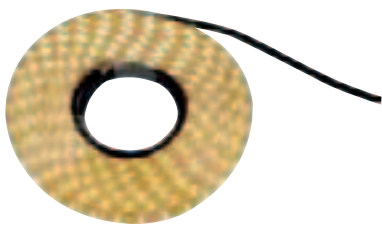
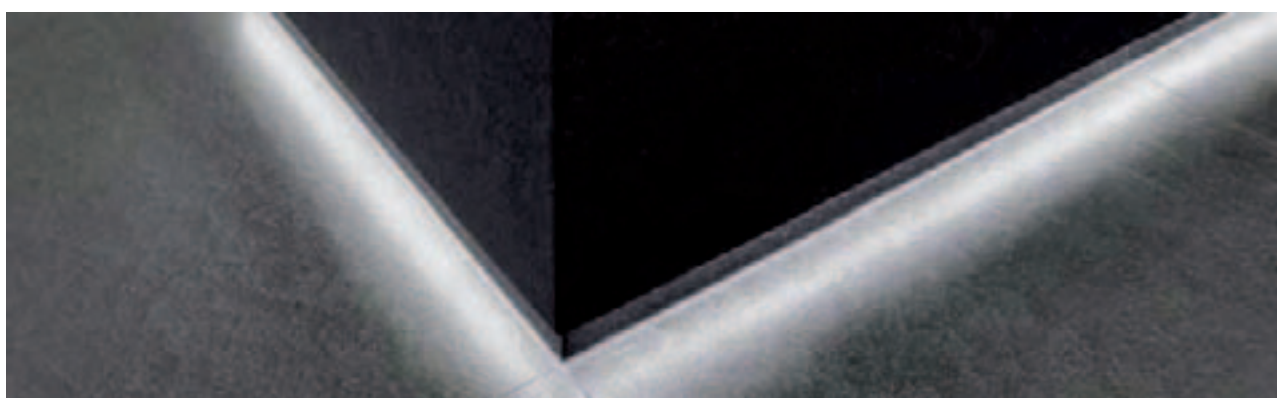

IP FLEXLED ROLL 24V=

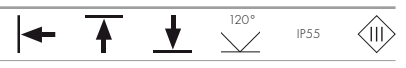

Bulb:
LED (incl.)

Accessory/Included parts:
Power unit (excl.)
Rear side equipped with adhesive tape.

Note:
Supply line-L: 50 cm.
Strip embedded in plastic.
Min. bending radius: 3,75 cm.
to max. -30°C up to +40°C
Not extendable.
From a length of 5 m a new feed-in must be made!

Recommended connection:
LED power unit, 20W, 24V=
470542

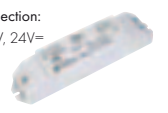

Article No.	Description	Colour	Voltage in DC	Power in W	LED distance in cm	LEDs per strip	LEDs per m	Length in m	Width in cm	Height in cm	Operating life in h	Separability in cm	Weight in kg	Price
552241	IP FlexLED Roll	white	24V	15	1,70	180	60	3,0	1,3	0,5	20000	every 10	0,20	
552242	IP FlexLED Roll	warm white	24V	15	1,70	180	60	3,0	1,3	0,5	20000	every 10	0,20	
552251	IP FlexLED Roll	white	24V	25	1,70	300	60	5,0	1,3	0,5	20000	every 10	0,33	
552252	IP FlexLED Roll	warm white	24V	25	1,70	300	60	5,0	1,3	0,5	20000	every 10	0,33	

When connecting several strips, please pay attention to the total wattage! Further power units can be found in the accessory range.



LED
LEDTEC



FLEXLED ROLL RGB 12V=



Bulb:
LED (incl.)

Accessory/Included parts:
Power unit (excl.)
Controller (excl.)
Rear side equipped with adhesive tape.

Note:
Min. bending radius: 1,3 cm
to max. +40°C
From a length of 3 m a new feed-in
must be made!
**At 5 m the power supply must be
made via a double-sided feed-in.**
New feed-in every 50 cm

**Recommended
connection:**
LED power unit, 60W, 12V=
470508

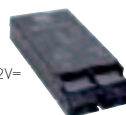

Recommended connection:
Easy LIM® Pro RF 12V=/24V=
Radio-Master controller
16,5W/channel, 12V=
33W/channel, 24V=
470600



Article No.	Description	LED colour	Voltage in DC	Power in W	LED distance in cm	LEDs per strip	LEDs per m	Length in m	Width in cm	Height in cm	Operating life in h	Separability in cm	Weight in kg	Price
552003	FlexLED Roll RGB	RGB	12V	7	2,77	36	36	1,0	1,0	0,22	20000	every 8,3	0,06	
552013	FlexLED Roll RGB	RGB	12V	21	2,77	108	36	3,0	1,0	0,22	20000	every 8,3	0,08	
552023	FlexLED Roll RGB	RGB	12V	35	2,77	180	36	5,0	1,0	0,22	20000	every 8,3	0,10	

When connecting several strips, please pay attention to the total wattage! Further power units and controllers can be found in the accessory range.

LED
LEDTEC



FLEXLED ROLL RGB 24V=



Bulb:
LED (incl.)

Accessory/Included parts:
Power unit (excl.)
Controller (excl.)
Supply line (excl.)
Rear side equipped with adhesive tape.

Note:
Min. bending radius: 1,3 cm
to max. +40°C
Not extendable.
From a length of 5 m a new feed-in
must be made!

**Recommended
connection:**
LED power unit, 100W, 24V=
470500

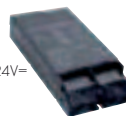

Recommended connection:
Easy LIM® Pro RF 12V=/24V=
Radio-Master controller
16,5W/channel, 12V=
33W/channel, 24V=
470600



Article No.	Description	LED colour	Voltage in DC	Power in W	LED distance in cm	LEDs per strip	LEDs per m	Length in m	Width in cm	Height in cm	Operating life in h	Separability in cm	Weight in kg	Price
552103	FlexLED Roll RGB	RGB	24V	10	2,10	48	48	1,0	1,5	0,20	20000	every 12,5	0,04	
552113	FlexLED Roll RGB	RGB	24V	30	2,10	144	48	3,0	1,5	0,20	20000	every 12,5	0,07	
552123	FlexLED Roll RGB	RGB	24V	50	2,10	240	48	5,0	1,5	0,20	20000	every 12,5	0,10	

When connecting several strips, please pay attention to the total wattage! Further power units and controllers can be found in the accessory range.

ACCESSORY for FlexLED Roll RGB 12V=

Feed-in with 30 cm cable, 2 pce.
10 mm, max. 25W
550414



Direct connector 2 pce.
10 mm, max. 25W
550417



ACCESSORY for FlexLED Roll RGB 24V=

Feed-in with 50 cm cable
15 mm, max. 50W
550418



Direct connector, 1 pce.
15 mm, max. 50W
550419







IP FLEXLED ROLL RGB 12V=



Bulb:
LED (incl.)

Accessory/Included parts:
Power unit (excl.)
Controller (excl.)
Supply line-L: 50 cm
Rear side equipped with adhesive tape.
Strip embedded in plastic.

Note:
Min. bending radius: 3,75 cm
to max. -30°C up to +40°C
Not extendable.

Recommended connection:
LED power unit, 60W, 12V=
470508

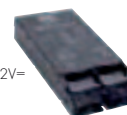

Recommended connection:
Easy LIM® Pro RF 12V=/24V=
Radio-Master controller
16,5W/channel, 12V=
33W/channel, 24V=
470600



Article No.	Description	LED colour	Voltage in DC	Power in W	LED distance in cm	LEDs per strips	LEDs per m	Length in m	Width in cm	Height in cm	Operating life in h	Separability in cm	Weight in kg	Price
552213	IP FlexLED Roll	RGB	12V	21	2,77	108	36	3,0	1,2	0,50	20000 h	every 8,3	0,41	
552223	IP FlexLED Roll	RGB	12V	35	2,77	180	36	5,0	1,2	0,50	20000 h	every 8,3	0,56	

When connecting several strips, please pay attention to the total wattage! Further controllers and power units can be found in the accessory range.

IP FLEXLED ROLL RGB 24V=



Bulb:
LED (incl.)

Accessory/Included parts:
Power unit (excl.)
Controller (excl.)
Supply line-L: 50 cm
Rear side equipped with adhesive tape.
Strip embedded in plastic.

Recommended connection:
Power LIM®2 RGB
Master controller 24V=
470581

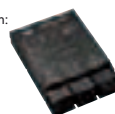

Recommended connection:
Remote control for
Master controller
470520



Recommended connection:
Power LIM®2 RGB
Slave controller 24V=
470582



Note:
Min. bending radius: 1,3 cm
to max. -30°C up to +40°C
Not extendable.

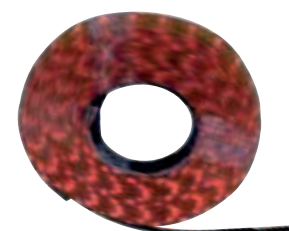

Article No.	Description	LED colour	Voltage in DC	Leistung in W	LED distance in cm	LEDs per strips	LEDs per m	Length in m	Width in cm	Height in cm	Operating life in h	Separability in cm	Weight in kg	Price
552243	IP FlexLED Roll	RGB	24V	30	2,10	144	48	3,0	1,8	0,40	20000 h	every 10	0,30	
552253	IP FlexLED Roll	RGB	24V	50	2,10	240	48	5,0	1,8	0,40	20000 h	every 10	0,50	

When connecting several strips, please pay attention to the total wattage! Further controllers and power units can be found in the accessory range.

ACCESSORY 1 for IP FlexLED Roll RGB 12V= and 24V=

Fastening clips, 100 pce.
550191





LED WALL PROFILE

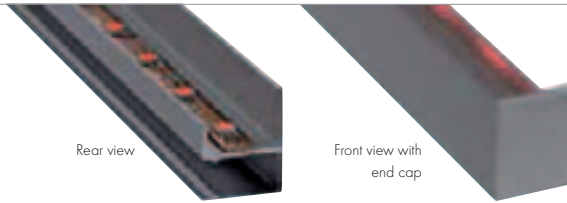
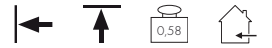

Material:
Aluminium

Versions:
alu anodized

Art. No.:
213312

Dimensions:
L/W/H: 200/2,3/3 cm
inner: 1,9 cm

Recommended accessory:
Mounting holder, 3 pce.
alu anodized
213320

Recommended accessory:
End caps
(left and right)
213321

Aluminium profile for the simple mounting of LED strips to create an indirect illumination. Suitable for strips with a maximum width of 1,9 cm!

LED WALL PROFILE up/down

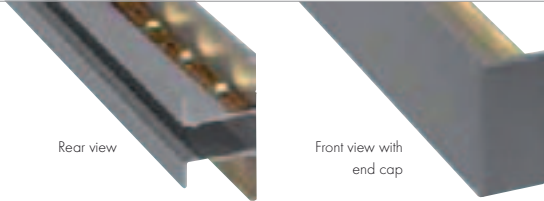

Material:
Aluminium

Versions:
alu anodized

Art. No.:
213352

Dimensions:
L/W/H: 200/2,3/4,6 cm
inner : 1,9 cm

Recommended accessory:
Mounting holder, 3 pce.
alu anodized
213320

Recommended accessory:
End caps, 2 pce.
silver grey, plastic
L/W/H: 0,2/2,3/4,6 cm
213361

Up/Down aluminium profile for the simple mounting of LED strips for indirect illumination. Suitable for strips with a maximum width of 1,9 cm!



LED flush-mounted profile (213332) see below



LED wall profile (213312) see above

LED FLUSH-MOUNTED PROFILE

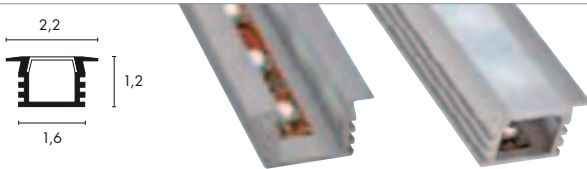

Material:
Aluminium/plastic

Versions:
Cover satined
alu anodized

Art. No.:
213332

Dimensions:
visible-L/W: 100/2,2 cm
inner: 1,1/0,9 cm

Aluminium profile for the simple mounting of LED strips. Suitable for strips with a maximum width of 1,1 cm!

LED PROFILE (rimless)

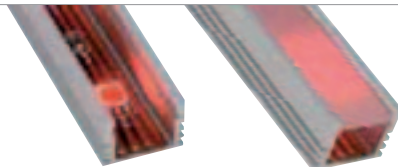

Material:
Aluminium/plastic

Versions:
Cover satined
alu anodized

Art. No.:
213342

Dimensions:
visible-L/W/H: 100/1,6/1,2 cm
inner: 1,6/1,1 cm

Aluminium profile for the simple mounting of LED strips. Suitable for strips with a maximum width of 1,1 cm!!



LED TUBELIGHT 24V=

24V=

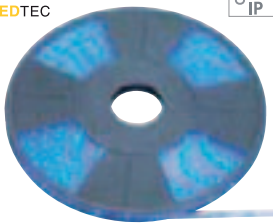

IP55

LED
LEDTEC

Bulb:
LED (incl.)

Accessory/Included parts:
LED converter (excl.)

Note:
Supply line-L: 50 cm.
Min. bending radius: 1,3 cm.
Note:

Plastic insulated LED strips with quadratic **cross section**, especially for application in stare nose profile. A maximum of 20m LED Tubelight can be operated by one feed-in. By an output of >44W a new feed-in must be made. Further power units can be found in the accessory range.

Recommended connection:
LED power unit, 24V=, 60W
470506



Article No.	Description	LED colour	Voltage in DC	Power in W	LED distance in cm	LEDs per strip	LEDs per m	Length in m	Width in cm	Height in cm	Separability in cm	Price
233001	LED Tubelight	white	24V	22	2,8	360	36	10,0	0,55	0,35	every 16,7	
233002	LED Tubelight	warm white	24V	22	2,8	360	36	10,0	0,55	0,35	every 16,7	
233007	LED Tubelight	blue	24V	22	2,8	360	36	10,0	0,55	0,35	every 16,7	

ACCESSORY for LED Tubelight

Feed-in set
233011

PC tube, 2m piece, 10x10 mm
Inner dimensions: 0,8 x 0,8 cm
211200

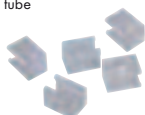
Longitudinal connector IP55
10 pce.
233012

Fastening clips for PC tube
10 pce.
211201

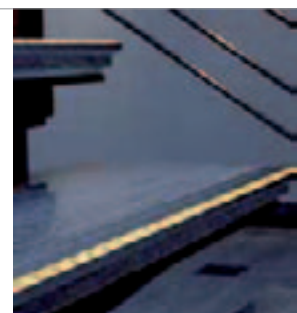
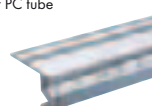
Mounting clips
100 pce.
233010

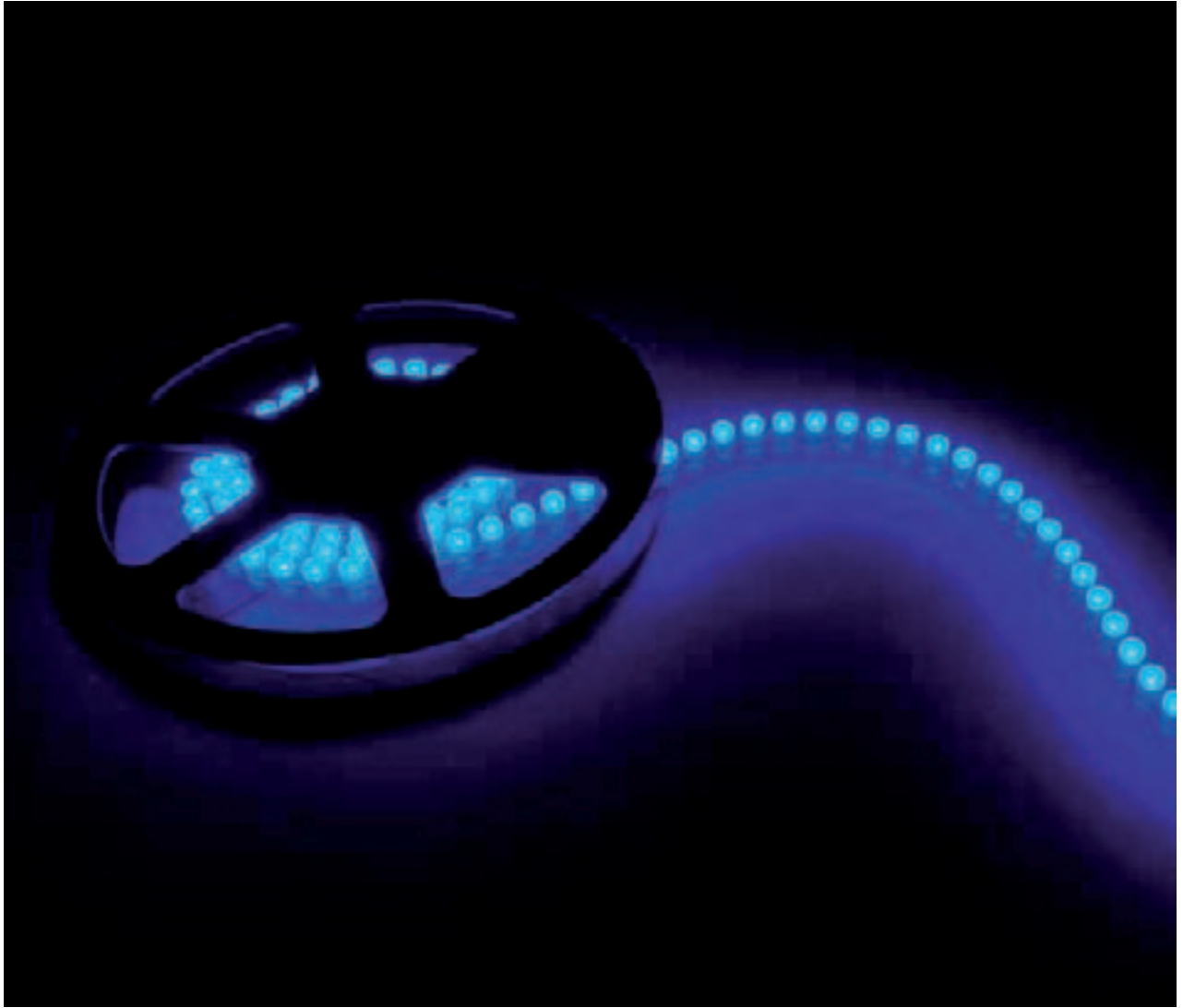
Stair nose profile for PC tube
2 m piece
213302

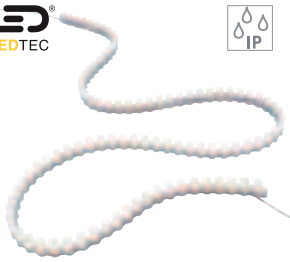

SILICONE LED FLEXSTRIP 12V=

12V=



Bulb:
LED (incl.)

Accessory/Included parts:
Power unit (excl.)

Note:
Supply line-L: 50 cm
Min. bending radius: 1,3 cm.
Further 12V= power units for
Silicone LED Flexstrips can be
found in the accessory range.

Note:
By an output of >25W a new
feed-in must be made.
Please pay attention that the
Silicone LED Flexstrip 300 is **not**
extendable.

Recommended connection:
LED power unit, 20W, 12V=
470541

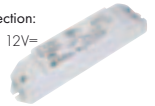

Article No.	Description	LED colour	Voltage in DC	Power in W	LED distance in cm	LEDs per strip	LEDs per m	Length in cm	Width in cm	Height in cm	Operating life in h	Separability	Weight in kg	Price
550621	Silikon LED Flexstrip 96	white	12V	6,6	0,5	96	100	96,0	0,75	1,4	10000	every 3 LEDs	0,07	
550622	Silikon LED Flexstrip 96	warm white	12V	6,6	0,5	96	100	96,0	0,75	1,4	10000	every 3 LEDs	0,07	
550627	Silikon LED Flexstrip 96	blue	12V	6,6	0,5	96	100	96,0	0,75	1,4	10000	every 3 LEDs	0,07	
550721	Silikon LED Flexstrip 300	white	12V	18	0,5	300	100	300,0	0,75	1,4	10000	every 3 LEDs	0,24	
550722	Silikon LED Flexstrip 300	warm white	12V	18	0,5	300	100	300,0	0,75	1,4	10000	every 3 LEDs	0,24	

ACCESSORY for Silicone LED Flexstrip

Mounting clips, 25 pce.
550630





LED STRIP OUTDOOR 100 PRO

24V ← ↑ ↓ 120° IP55 III

LED[®]
LEDTEC



Bulb:
SMD LED (incl.)

Material:
Aluminium/artificial resin

Dimensions:
Supply line-L: 10 cm

Accessory/Included parts:
Power unit (excl.)
Connector and coupler (incl.)

Note:
Strips cast in artificial resin.
Dimmable with PWM converter.
Operating temperature
max. +40°C.

Please protect from direct solar
radiation.
By an output of >50W a new
feed-in must be made!
Further power units can be found in
the accessory range

Recommended connection:
LED power unit
12W, 24V=
470502



Recommended connection:
1 channel PWM converter
100W, 24V=
470550



Article No.	Description	LED colour	Voltage in DC	Power in W	LED distance in cm	LEDs per strip	LEDs per m	Length in cm	Width in cm	Height in cm	Operating life in h	Weight in kg	Price
552301	LED strip Outdoor 100 Pro	white	24V	8,5	0,8	96	96	100,5	2,0	1,5	20000	0,47	
552302	LED strip Outdoor 100 Pro	warm white	24V	8,5	0,8	96	96	100,5	2,0	1,5	20000	0,47	
552307	LED strip Outdoor 100 Pro	blue	24V	8,5	0,8	96	96	100,5	2,0	1,5	20000	0,47	

When connecting several strips, please pay attention to the total wattage! Further power units can be found in the accessory range.

ACCESSORY for LED strips Outdoor 100 Pro

Feed-in cable IP65, 50W max.
4-pole
Cable-L: 5 m
229821



Connector cable IP65, 50W max.
4-pole
Cable-L: 1 m
229820



Holding clamp 10 pce.
552300

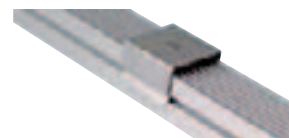
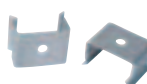



ACCESSORY

Converters/Dimmer



630

LED controllers



630-634

LED drivers

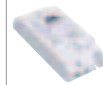

635, 636

LED power units

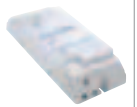

637, 638

Ballasts
conventional /
electronic



639

Transformers
conventional



640, 641

IP Transformers
conventional



640, 641

Transformers
electrical



642, 643

Connection boxes



643

General
accessories



644, 645

SCHEMATIC DIAGRAM

Parallel connection by larger loads.
By an output of >50W a new feed-in must be made.

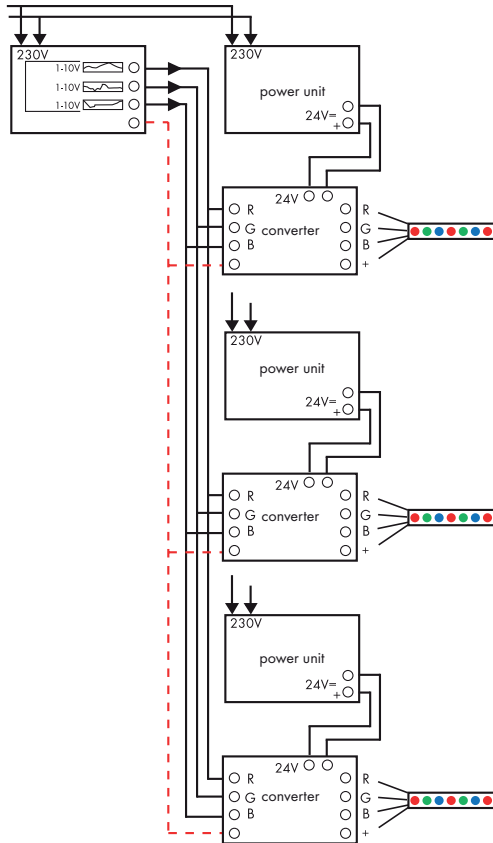

SCHEMATIC DIAGRAM

Application with EP1 dimmer 1-10V and 3 channel converter.

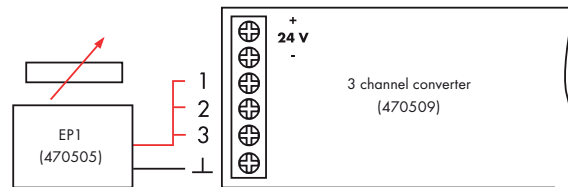

PWM CONVERTER 1 CHANNEL 12V=/24V=

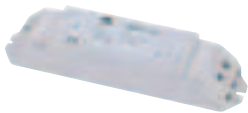

Article No.	Description	Voltage primary in DC	Voltage secondary in DC	Output power	Specification	Length in cm	Width in cm	Height in cm	Price
470550	PWM converter 1 channel	12V 24V	12V 24V	50W max. 100W max.	ta: 50°C/tc: 70°C	170	4,0	3,0	
For dimming of 12V DC and 24V DC single colour strip applications. Independent converter. Control voltage: 1-10V. Output: 4,1A.									

PWM CONVERTER 3 CHANNEL 12V=/24V=

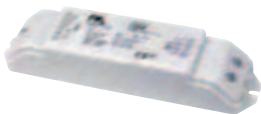

Article No.	Description	Voltage primary in DC	Voltage secondary in DC	Output power per channel	Specification	Length in cm	Width in cm	Height in cm	Price
470509	PWM converter 3 channel	12V 24V	12V 24V	16,6W 33,3W	ta: 50°C/tc: 70°C	170	4,0	3,0	
For controlling of 12V DC and 24V DC among others for RGB strips. Independent converter. Control voltage: 3x 1-10V. Output: 3x 1,4A max.									

PWM CONVERTER 3 CHANNEL 350mA

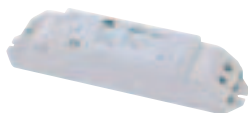

Article No.	Description	Voltage primary in DC	Voltage secondary in mA	Output power per channel	Specification	Length in cm	Width in cm	Height in cm	Price
470560	PWM converter 3 channel	24V	350	7W	ta: 50°C/tc: 70°C	170	4,0	3,0	
For controlling of 350mA applications with max. 5x 1W PowerLED per channel. Independent converter. Control voltage: 3x 1-10V. Output: 3x 350mA max.									

EP1 DIMMER 1-10V



Article No.	Description	Power	Length in cm	Width in cm	Height ¹ in cm	Height ² in cm	Axial-Ø in cm	Weight in kg	Price
470505	EP1 Dimmer 1-10V	10W max.	2,3	3,9	2,0	3,6	0,6	0,04	
For the connection to controllers with 1-10V control voltage.									

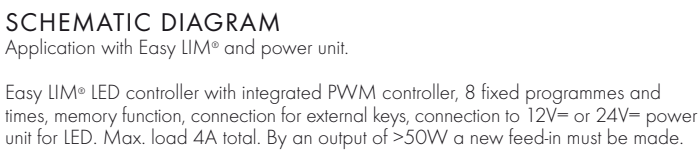
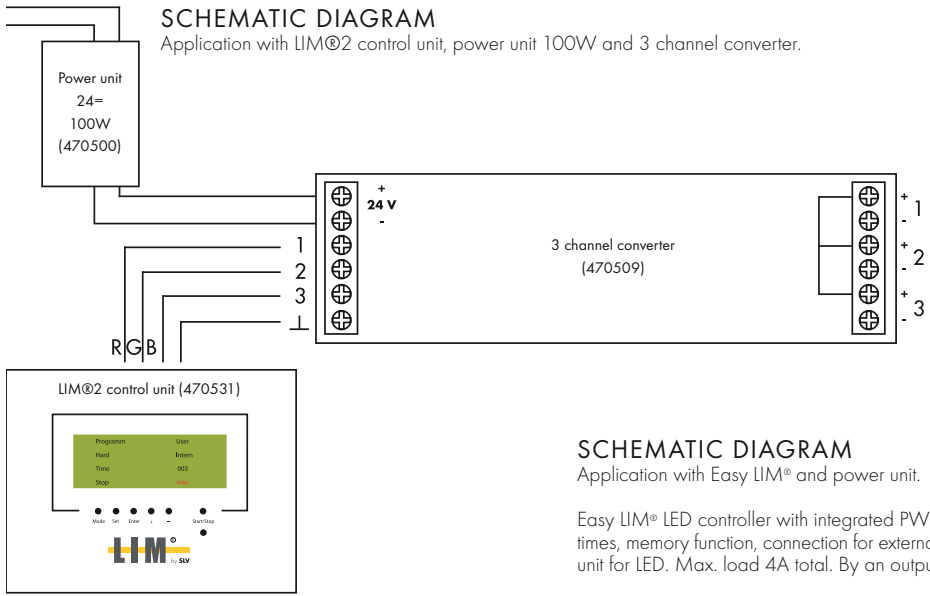

LIM®2 CONTROL UNIT



Article No.	Description	Colour	Voltage in AC	Control-voltage	Width in cm	Height in cm	Depth in cm	Price
470531	LIM®2 control unit	alu natural	230V	4x 1-10V	11,7	3,7	9,7	
Accessory/Included parts: Flush-mounted housing (incl.), IR-receiver at the front of the housing (incl.). With LCD-display. Optionally controllable via remote control (470530). Flush-mounted installation is possible. Short circuit protected.								

The LIM®2 4-channel control unit makes setting and calling up of colour of light or light level possible on keystrokes. 4 groups of lights with digital operating devices for a control voltage of 1-10 V (e.g. fluorescent bulbs, low-voltage halogen, high volt halogen bulbs or LED applications) can be controlled, 4 light sequences pre-programmed can also be called up by keystrokes. Also a dynamic operational sequence of the setup light scenes is possible owing to selectable standing and blend over times. 4 different sequencing programs with 8 light scenes each are already programmed in the system. Further features are panic configuration, external switching entrance, variable time intervals. It is a comfortable system, whereby no prior knowledge is needed to operate it.

REMOTE CONTROL for LIM®2 control unit



Article No.	Description	Accessory/Included parts	Length in cm	Width in cm	Height in cm	Price
470530	Remote control	2x AA 1,5V Batteries (excl.)	17,8	4,3	2,0	
Infrared remote control to control the LIM® 2 control unit (470531).						

LED POWER UNIT 100W, 24V=

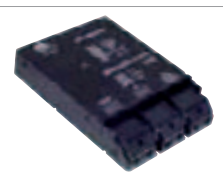

Article No.	Description	Voltage primary in AC	Voltage secondary in DC	Output power per channel	Specification	Length in cm	Width in cm	Height in cm	Price
470540	LED power unit 100W dimmable	230V	24V	33W	ta: 50°C/tc: 70°C	18,5	13,0	3,5	
Dimmable with EP1 dimmer (470505) see left or LIM® 2 control unit (470531) see above. Dimming range: 0% -100%. Control voltage: 3x 1-10V.									

EASY LIM® LED CONTROL UNIT

12=
or
24=

easy LIM

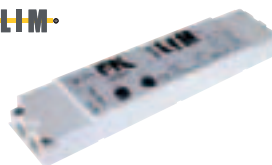

Article No.	Description	Voltage primary in DC	Voltage secondary in DC	Output power per channel	Length in cm	Width in cm	Height in cm	Price
470503	LED control unit	12V 24V	12V 24V	15W max. 31W max.	18,5	4,5	1,9	

Accessory/Included parts: Integrated PWM converter to RGB output signal (incl.).
Connection to 12V= or 24V= LED power unit. Eight fixed programmes and times. Memory function. Connection for external keys.
Max. load 4A total.

EASY LIM® PRO RF MASTER CONTROLLER radio, 12V=/24V=, 3 channel

12=
or
24=

easy LIM PRO RF

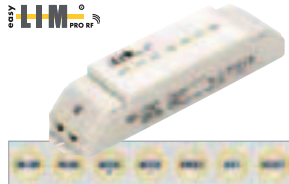

Article No.	Description	Voltage primary in DC	Voltage secondary in DC	Output power per channel	Specification	Length in cm	Width in cm	Height in cm	Price
470600	Master controller radio	12V 24V	12V 24V	16,5W 33W	ta: 50°C/tc: 60°C	16,6	3,9	3,3	

Accessory/Included parts: Power unit (excl.). Remote control (470601) optional (excl.).
17 fixed programmes, pause function, fade speed and brightness adjustable, on-off function, memory function by mains disconnection.
Receiving frequency by remote control operation can be adjusted via dip switches.
Output 3x 1,38A

EASY LIM® PRO RF SLAVE radio, 12V=/24V=, 3 channel

12=
or
24=

easy LIM PRO RF

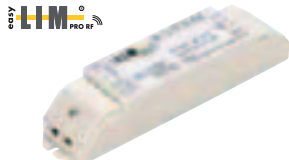

Article No.	Description	Voltage primary in DC	Voltage secondary in DC	Output power per channel	Specification	Length in cm	Width in cm	Height in cm	Price
470602	Slave controller radio	12V 24V	12V 24V	16,5W 33W	ta: 50°C/tc: 60°C	16,6	3,9	3,3	

Accessory/Included parts: Power unit (excl.)
For extension of the Easy LIM® Pro RF Master controller (470600). Output 3x 1,38A

EASY LIM® PRO RF MASTER CONTROLLER radio, 350mA, 3 channel

24=
mA
350

easy LIM PRO RF

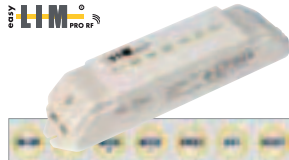

Article No.	Description	Voltage primary in DC	Voltage secondary in mA	Output power per channel	Specification	Length in cm	Width in cm	Height in cm	Price
470610	Master controller radio	24V	350	5W max.	ta: 50°C/tc: 60°C	16,6	3,9	3,3	

Accessory/Included parts: Power unit (excl.). Remote control (470601) optional (excl.).
17 fixed programmes, pause function, fade speed and brightness adjustable, on-off function, memory function by mains disconnection.
Receiving frequency by remote control operation can be adjusted via dip switches.

EASY LIM® PRO RF SLAVE CONTROLLER radio, 350mA, 3 channel

24=
mA
350

easy LIM PRO RF



Article No.	Description	Voltage primary in DC	Voltage secondary in mA	Output power per channel	Specification	Length in cm	Width in cm	Height in cm	Price
470612	Slave controller radio	24V	350	5W max.	ta: 50°C/tc: 60°C	16,6	3,9	3,3	

Accessory/Included parts: Power unit (excl.)
For extension of the Easy LIM® Pro RF Master controller (470610). Independent converter.

RADIO TRANSMITTER for Easy LIM® Pro RF, radio

12=



easy LIM PRO RF

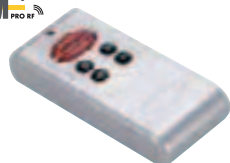

Article No.	Description	Voltage in DC	Length in cm	Width in cm	Height in cm	Battery	Price
470601	Radio transmitter	12V	8,5	3,7	1,7	1x 12V	

Accessory/Included parts: 1x 12V-Battery e.g. LRV08 (excl.) see below.
Radio remote control to control the Easy LIM® Pro RF Master controller (470600/-10). Transmitting frequency can be adjusted via dip switches.

BATTERY for Radio transmitter (470601)

12=

easy LIM

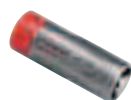

Article No.	Description	Voltage in DC	Price
470620	Battery LRV08	12V	

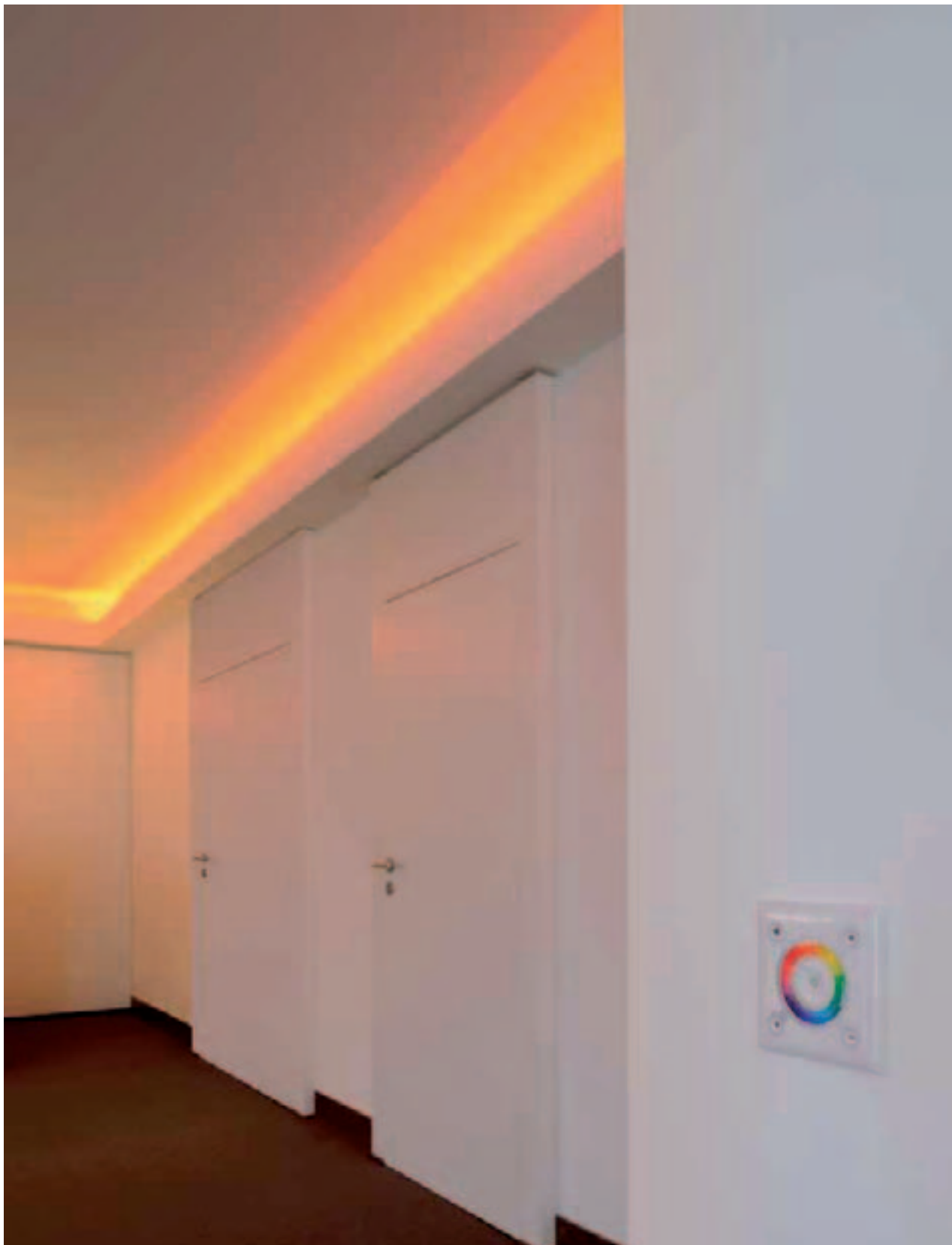

RGB LED CONTROLLER FOR WALL MOUNTING

12=
or
24=LIM^o

Article No.	Description	Colour	Voltage primary in DC	Power	Width in cm	Height in cm	Depth in cm	Installation dimensions in cm	Installation depth in cm	Price
470700	RGB Controller	white	12V 24V	3x 16,5W 3x 33W	8,6	8,6	1,3	Ø 5,0	3,5	

Special functions:

Colour wheel with brighter/darker function. White button with brighter/darker function. Slow colour run with brighter/darker/speed function.
Suitable for mounting in flush-mounted and cavity wall boxes with a diameter of 60 mm and depth of min. 41 mm.

Wire cross-section: 1mm² max.

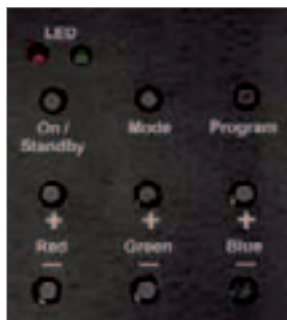

Detail picture: Control unit of the Power LIM®2 RGB master controller.

POWER LIM®2 RGB Master controller 24V=

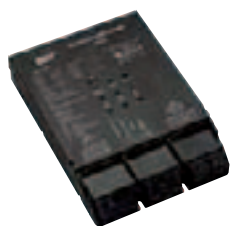

Article No.	Description	Voltage primary in AC	Voltage secondary in DC	Output power per channel	Specification	Power factor	Length in cm	Width in cm	Height in cm	Price
470581	Master controller	230V	24V	3x 20W	ta: 50°C/tc: 60°C	0,95 λ	18,5	13,0	3,5	

Accessory/Included parts: Integrated power unit 60W (incl.). Secondary cable length: 30 m max.

Extendable up to 9 slave controllers.

All constant voltage and constant current appliances of this series are compatible and connectable with each other.

POWER LIM®2 RGB Slave controller 24V=

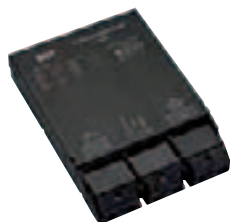

Article No.	Description	Voltage primary in AC	Voltage secondary in DC	Output power per channel	Specification	Power factor	Length in cm	Width in cm	Height in cm	Price
470582	Slave controller	230V	24V	3x 20W	ta: 50°C/tc: 60°C	0,95 λ	18,5	13,0	3,5	

Accessory/Included parts: Integrated power unit 60W (incl.). Control line: 1,2 m (incl.). Secondary cable length: 30 m max.

Control line is not extendable. For extension of the Master controller (470581).

All constant voltage and constant current appliances of this series are compatible and connectable with each other.

POWER LIM®2 RGB Master controller 350mA

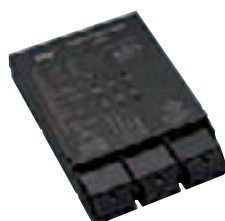

Article No.	Description	Voltage primary in AC	Constant current secondary in mA	Output power per channel	Specification	Power factor	Length in cm	Width in cm	Height in cm	Price
470583	Master controller	230V	350	3x 7W	ta: 50°C/tc: 60°C	0,95 λ	18,5	13,0	3,5	

Accessory/Included parts: Integrated controller for 1W PowerLED, 21W max. (incl.). Secondary cable length: 20 m max.

Extendable up to 9 slave controllers.

The first two slave controller can be provided with the voltage supply of the master controller.

All constant voltage and constant current appliances of this series are compatible and connectable with each other.

POWER LIM®2 RGB Slave controller 350mA



Article No.	Description	Voltage primary in DC	Constant current secondary in mA	Output power per channel	Specification	Power factor	Length in cm	Width in cm	Height in cm	Price
470584	Slave controller	24V	350	3x 7W	ta: 50°C/tc: 65°C	0,95 λ	17,5	7,8	3,5	

Accessory/Included parts: Power unit (excl.). Control line: 1,2 m (incl.). Secondary cable length: 20 m max.

Control line is not extendable. For extension of the Master controller (470583).

All constant voltage and constant current appliances of this series are compatible and connectable with each other.

Max. 5x 1W PowerLED, max. 21W.

REMOTE CONTROL for Power LIM®2 master controllers



Article No.	Description	Length in cm	Width in cm	Height in cm	Price
470520	Remote control	17,8	4,8	1,9	

Accessory/Included parts: Batteries (excl.). IR-receiver (incl)

Infrared remote control to control the Power LIM®2 master controllers (470581 /-3).

LED DRIVER 3W, 350mA

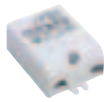

Article No.	Description	Constant current secondary in mA	Power	Number of LED	Specification	Power factor	Length in cm	Width in cm	Height in cm	Price
464108	LED driver 3W	350	1-3W	1-3 LED 1W	ta: 50°C/tc: 70°C	0,4 λ	5,5	3,9	2,0	

With strain relief. Fits into connection box [229260] see page 643.

LED DRIVER 8W, 350mA



Article No.	Description	Constant current secondary in mA	Power	Number of LED	Specification	Power factor	Length in cm	Width in cm	Height in cm	Price
464109	LED driver 8W	350	1-9W	1-6 LED 1W	ta: 50°C/tc: 70°C	0,4 λ	8,5	4,1	2,2	

Independent converter. Short-circuit-proof.

LED DRIVER 8,5W, 350mA



Article No.	Description	Constant current secondary in mA	Power	Number of LED	Specification	Power factor	Length in cm	Width in cm	Height in cm	Price
464301	LED driver 8,5W	350	8,5W	3-6 LED 1W or 2x LED insert 3x 1W	ta: 50°C/tc: 80°C		9,0	4,0	2,3	

LED DRIVER 11W, 350mA



Article No.	Description	Constant current secondary in mA	Power	Number of LED	Specification	Power factor	Length in cm	Width in cm	Height in cm	Price
464112	LED driver 11W dimmable	350mA	1-11W	9 LED 1W	ta: 50°C/tc: 75°C	0,4 λ	20,0	4,3	3,9	

With strain relief. Dimmable with EP1 Dimmer [470505] see page 630.

LED DRIVER 12W, 350mA



Article No.	Description	Constant current secondary in mA	Power	Number of LED	Specification	Power factor	Length in cm	Width in cm	Height in cm	Price
464110	LED driver 12W	350mA	6-12W	5-9 LED 1W	ta: 50°C/tc: 70°C	0,95 λ	16,7	3,9	3,0	

With strain relief. Fits into transformer box IP67 [229261] see page 643. With socket for connector strip [111850/60] see page 636.

LED DRIVER 18W, 350mA



Article No.	Description	Constant current secondary in mA	Power	Number of LED	Specification	Power factor	Length in cm	Width in cm	Height in cm	Price
464111	LED driver 18W	350	10-18W	9-15 LED 1W	ta: 50°C/tc: 70°C	0,95 λ	15,3	6,7	3,5	

With strain relief. With socket for connector strip [111850/60] see page 636.

LED DRIVER 8W, 480mA



Article No.	Description	Constant current secondary in mA	Power	Number of LED	Specification	Power factor	Length in cm	Width in cm	Height in cm	Price
464120	LED driver 8W	480	1-9W	1 LED	ta: 50°C/tc: 70°C	0,55 λ	8,5	4,04	2,2	

Only for operation with Boost Turno 9W Downlight [160621/-24] see page 368 and Boost IP44 9W Downlight [160631/-34] see page 370.
Short-circuit-proof. Diameter connection cable: 0,75-1,5 cm

LED DRIVER 3W, 700mA



Article No.	Description	Constant current secondary in mA	Power	Number of LED	Specification	Power factor	Length in cm	Width in cm	Height in cm	Price
464200	LED driver 3W	700	1-3W	1 LED 3W	ta: 50°C/tc: 70°C	0,4 λ	5,5	4,0	2,0	
With strain relief. Fits into connection box (229260) see page 643.										

LED DRIVER 10W, 700mA



Article No.	Description	Constant current secondary in mA	Power	Number of LED	Specification	Power factor	Length in cm	Width in cm	Height in cm	Price
464001	LED driver 10W dimmable	700	3x 3W	1-3 LED 3W	ta: 50°C/tc: 80°C	0,95 λ	12,0	4,5	2,0	
Dimmable with trailing-edge phase dimmer. Dimming range: 25% - 100%.										

LED DRIVER 12W, 700mA



Article No.	Description	Constant current secondary in mA	Power	Number of LED	Specification	Power factor	Length in cm	Width in cm	Height in cm	Price
464202	LED driver 12W	700	6-12W	2-4 LED 3W	ta: 50°C/tc: 70°C	0,95 λ	16,7	3,9	3,0	
With strain relief.										

LED DRIVER 18W, 700mA



Article No.	Description	Constant current secondary in mA	Power	Number of LED	Specification	Power factor	Length in cm	Width in cm	Height in cm	Price
464201	LED driver 18W	700	10-18W	4-6 LED 3W	ta: 50°C/tc: 70°C	0,95 λ	15,3	6,7	3,5	
With strain relief.										

LED DRIVER 30W, 700mA

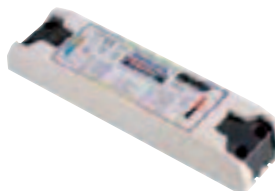

Article No.	Description	Constant current secondary in mA	Power	Number of LED	Specification	Power factor	Length in cm	Width in cm	Height in cm	Price
464002	LED driver 30W dimmable	700	10x 3W	5-10 LED 3W	ta: 50°C/tc: 85°C	0,95 λ	18,0	4,5	2,8	
Dimmable with trailing-edge phase dimmer. Dimming range: 25% - 100%.										

LED DRIVER 15W, 1200mA



Article No.	Description	Constant current secondary in mA	Power	Number of LED	Specification	Power factor	Length in cm	Width in cm	Height in cm	Price
464210	LED driver 15W	1200	5-15W	1 LED 15W	ta: 50°C/tc: 75°C	0,95 λ	16,7	3,9	3,0	
Only for operation with 15W LED Downlight (160401/02/-11/-12) see page 378. Independent converter. With strain relief.										

CONNECTOR STRIP 3 outlets

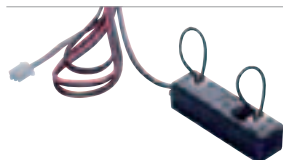

Article No.	Description	Colour	Power	Length in cm	Width in cm	Height in cm	Supply line-L in m	Price
111850	Connector strip 3 outlets	black	350mA max.	5,2	1,4	1,3	1,0	
Series connection. 3 outlets incl. 2 bridges.								

CONNECTOR STRIP 6 outlets

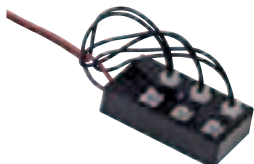

Article No.	Description	Colour	Power	Length in cm	Width in cm	Height in cm	Supply line-L in m	Price
111860	Connector strip 6 outlets	black	350mA max.	5,2	3,0	1,3	1,5	
Series connection. 6 outlets incl. 3 bridges.								

LED POWER UNIT 12W, 12V=



Article No.	Description	Voltage secondary in DC	Output power	Specification	Power factor	Length in cm	Width in cm	Height in cm	Price
470507	LED power unit 12W	12V	0-12W	ta: 50°C/tc: 85°C	0,4 λ	8,5	4,0	2,3	

LED POWER UNIT 20W, 12V=



Article No.	Description	Voltage secondary in DC	Output power	Specification	Power factor	Length in cm	Width in cm	Height in cm	Price
470541	LED power unit 20W	12V	0-20W	ta: 50°C/tc: 75°C	0,95 λ	16,6	3,9	3,3	

LED POWER UNIT 36W, 12V=



Article No.	Description	Voltage secondary in DC	Output power	Specification	Power factor	Length in cm	Width in cm	Height in cm	Price
470543	LED power unit 36W	12V	0-36W	ta: 50°C/tc: 75°C	0,9 λ	12,9	7,5	3,2	

LED POWER UNIT 60W, 12V=

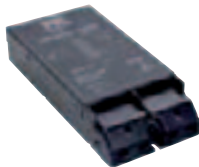

Article No.	Description	Voltage secondary in DC	Output power	Specification	Power factor	Length in cm	Width in cm	Height in cm	Price
470508	LED power unit 60W	12V	0-60W	ta: 50°C/tc: 70°C	0,95 λ	18,2	8,8	3,5	

LED POWER UNIT 12W, 24V=



Article No.	Description	Voltage secondary in DC	Output power	Specification	Power factor	Length in cm	Width in cm	Height in cm	Price
470502	LED power unit 12W	24V	0-12W	ta: 50°C/tc: 85°C	0,4 λ	8,5	4,0	2,3	

LED POWER UNIT 20W, 24V=

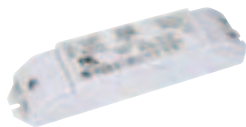

Article No.	Description	Voltage secondary in DC	Output power	Specification	Power factor	Length in cm	Width in cm	Height in cm	Price
470542	LED power unit 20W	24V	0-20W	ta: 50°C/tc: 75°C	0,95 λ	16,3	3,9	3,3	

LED POWER UNIT 36W, 24V=



Article No.	Description	Voltage secondary in DC	Output power	Specification	Power factor	Length in cm	Width in cm	Height in cm	Price
470544	LED power unit 36W	24V	0-36W	ta: 50°C/tc: 70°C	0,9 λ	12,9	7,5	3,2	

LED POWER UNIT 60W, 24V=

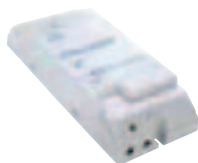

Article No.	Description	Voltage secondary in DC	Output power	Specification	Power factor	Length in cm	Width in cm	Height in cm	Price
470506	LED power unit 60W	24V	0-60W	ta: 50°C/tc: 70°C	0,95 λ	17,5	7,8	3,5	

LED POWER UNIT 100W, 24V=

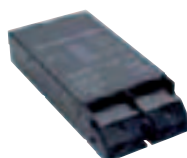

Article No.	Description	Voltage secondary in DC	Output power	Specification	Power factor	Length in cm	Width in cm	Height in cm	Price
470500	LED power unit 100W	24V DC	0-100W	ta: 50°C/tc: 70°C	0,95 λ	18,2	8,8	3,5	

LED POWER UNIT 60W, 12V=

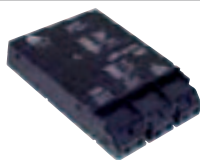

Article No.	Description	Voltage secondary in DC	Output power per channel	Specification	Length in cm	Width in cm	Height in cm	Price
470539	LED power unit 60W dimmable	12V	3x 20W	ta: 50°C/tc: 75°C	18,5	13,0	3,5	
Dimmable with EP1 Dimmer (470505) see page 630 or LIM® 2 control unit (470531) see page 631. Dimming range: 0% -100%. Control voltage: 3x 1-10V. Output: 3x 1,66A max.								

LED POWER UNIT 100W, 24V=

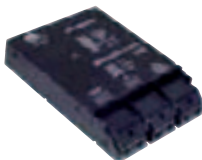

Article No.	Description	Voltage secondary in DC	Output power per channel	Specification	Length in cm	Width in cm	Height in cm	Price
470540	LED power unit 100W dimmable	24V	3x 33W	ta: 50°C/tc: 70°C	18,5	13,0	3,5	
Dimmable with EP1 Dimmer (470505) see page 630 or LIM® 2 control unit (470531) see page 631. Dimming range: 0% -100%. Control voltage: 3x 1-10V. Output: 3x 1,4A max.								

LED WALL POWER SUPPLY 16W, 24V=



Article No.	Description	Voltage secondary in DC	Output power	Specification	Length in cm	Width in cm	Height in cm	Price
470571	LED wall power supply 16W	24V	16W	ta: 50°C/tc: 70°C	8,8	4,2	9,1	
Secondary cable length: 2 m with open cable end.								

LED POWER UNIT BOX INSTALLATION 12W, 12V= / 24V=



Article No.	Description	Voltage secondary in DC	Output power	Specification	Ø in cm	Height in cm	Price	
470545	LED power unit box installation 12W	12V	12W	ta: 50°C/tc: 80°C	5,5	2,2		
470546	LED power unit box installation 12W	24V	12W	ta: 50°C/tc: 80°C	5,5	2,2		
Suitable for installation in switch boxes with a Ø of 60 mm. Short-circuit-proof. Primary cable length: 12,5 cm / Secondary cable length: 14,5 cm.								

LED DRIVER BOX INSTALLATION 8W, 350mA



Article No.	Description	Constant current secondary in mA	Output power	Specification	Power factor	Ø in cm	Height in cm	Price
464113	LED driver box installation 8W	350	8x 1W	ta: 50°C/tc: 70°C	0,4 λ	5,5	2,2	
Suitable for installation in switch boxes with a Ø of 60 mm. Short-circuit-proof. Primary cable length: 12,5 cm / Secondary cable length: 14,5 cm.								

LED DRIVER BOX INSTALLATION 9W, 700mA

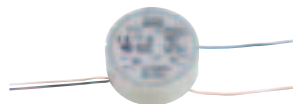

Article No.	Description	Constant current secondary in mA	Output power	Specification	Power factor	Ø in cm	Height in cm	Price
464203	LED driver box installation 9W	700	3x 3W PowerLED	ta: 50°C/tc: 70°C	0,4 λ	5,5	2,2	
Suitable for installation in switch boxes with a Ø of 60 mm. Short-circuit-proof. Primary cable length: 12,5 cm / Secondary cable length: 14,5 cm.								

CONVENTIONAL BALLAST PROFI 70/150 230~

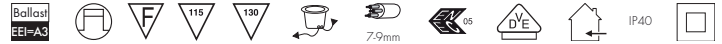

Article No.	Description	Voltage in AC	Power	Power factor	Length in cm	Width in cm	Height in cm	Weight in kg	Price
470070	Ballast Profi 70	230V	70W	0,91 λ	17,5	7,2	6,1	1,32	
470150	Ballast Profi 150	230V	150W	0,91 λ	21,4	7,2	6,1	2,25	

Accessory/Included parts: Strain relief (incl.), Ignition device with automatic switch-off (incl.), End of Life shut-off (incl.)
 For HIT, HIT-DE or HIT-CE. Not suitable for operation with HIPAR, Britespot ES111 and CDM-R 111 bulbs. Distance to lamp: 10 m max.
 Only usable with high-voltage connection line.

ELECTRONIC BALLAST HID, 20W



Article No.	Description	Voltage in AC	Power	Specification	Power factor	Ignition voltage	Length in cm	Width in cm	Height in cm	Price
470350	E-BALLAST HQI/CDM	230V	20W	ta: 50°C/tc: 75°C	0,55 λ	< 4 kv	16,6	3,9	3,3	

For Precise™ Constant Color™, MR16 and CMH MR16 Precise™ Constant Color™, GX10 bulbs.
 Secondary cable length max. 2 m. Short-circuit-proof. Only usable with high-voltage connection line.

ELECTRONIC BALLAST HID, 35W

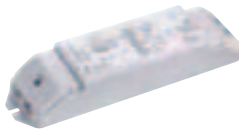

Article No.	Description	Voltage in AC	Power	Specification	Power factor	Ignition voltage	Length in cm	Width in cm	Height in cm	Price
470361	E-BALLAST 35W	230V	35W	ta: 50°C/tc: 70°C	0,98 λ	< 5 kv	20,0	3,9	3,0	

Secondary cable length max. 2 m. For HID bulbs 35W. Only usable with high-voltage connection line.

ELECTRONIC BALLAST HID, 2x35W



PHILIPS

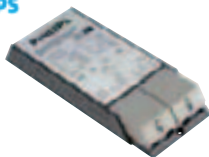

Article No.	Description	Voltage in AC	Power	Specification	Power factor	Ignition voltage	Length in cm	Width in cm	Height in cm	Price
470200	E-BALLAST 2x35W	230V	2x35W	ta: 55°C/tc: 80°C	0,95 λ	< 4,5 kv	17,5	7,95	3,5	

For all CDM bulbs 2x35W. Secondary cable lengths max. 1,5 m. Only usable with high-voltage connection line.

ELECTRONIC BALLAST HID, 35W, 70W, 150W

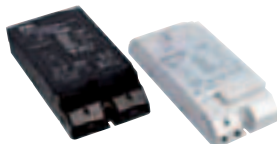

Article No.	Description	Voltage in AC	Power	Specification	Power factor	Ignition voltage	Length in cm	Width in cm	Height in cm	Weight in kg	Price
470360	E-BALLAST HQI/CDM 35W	230V	35W	ta: 50°C/tc: 75°C	0,95 λ	< 5 kv	17,3	7,7	3,1	0,6	
470370	E-BALLAST HQI/CDM 70W	230V	70W	ta: 50°C/tc: 75°C	0,98 λ	< 5 kv	17,3	7,7	3,1	0,6	
470380	E-BALLAST HQI/CDM 150W	230V	150W	ta: 50°C/tc: 85°C	0,98 λ	< 5 kv	19,2	8,7	3,6	0,6	

Flicker-free light. Extension of the operating life of up to 50%. Automatic shut-off in case of defective or missing bulb.
 Secondary cable lengths max. 2 m. Only usable with high-voltage connection line.

CONNECTION LINE for HID application



Article No.	Description	Line length in m	Ignition voltage resistant up to	Price
961062	High-voltage connection line	2,0	5 kv	

Note: For HQI/CDM ballasts SO-2GMH2G-j 3x 1 mm²

Conventional transformers should always be working to 80% capacity. The here illustrated transformers can be dimmed with leading-edge phase dimmer. In dimmed phase a minor operating noise can be possible. Please adhere to the manufacturers guidelines.

CONVENTIONAL TRANSFORMER MANTA 200, 300

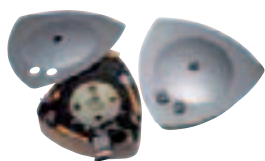

Article No.	Description	Colour	Voltage in AC/AC	Power	Secondary fused	Ø in cm	Height in cm	Weight in kg	Price
455202	Manta 200	chrome	230V/12V	200VA	1x 20A	20,0	8,0	2,75	
455209	Manta 200	silver grey	230V/12V	200VA	1x 20A	20,0	8,0	2,75	
455302	Manta 300	chrome	230V/12V	300VA	2x 15A	20,0	8,0	3,8	
455309	Manta 300	silver grey	230V/12V	300VA	2x 15A	20,0	8,0	3,8	

TRANSFORMER 100VA, 200VA



Article No.	Description	Colour	Voltage in AC/AC	Power	Ø in cm	Height in cm	Weight in kg	Price
138812	Toroidal transformer 100VA	chrome	230V/12V	100VA	12,5	9,5	1,7	
138822	Toroidal transformer 200VA	chrome	230V/12V	200VA	15,5	11,5	2,7	

ARTE 300



Article No.	Description	Colour	Voltage in AC/AC	Power	Ø in cm	Height in cm	Price
167032	Toroidal transformer Arte 300	chrome	230V/12V	300VA	16,0	9,5	
167039	Toroidal transformer Arte 300	silver grey	230V/12V	300VA	16,0	9,5	

IP44 TRANSFORMER 10VA/12V~



Article No.	Description	Voltage in AC/AC	Power	Length in cm	Width in cm	Height in cm	Price
451010	IP44 Transformer 10VA	230V/12V	10VA	5,5	8,0	5,0	
Accessory/Included parts: Plug (incl.)							
Primary cable-L: 2 m, Secondary cable-L: 2 m							

IP44 TRANSFORMER 60VA/12V~



Article No.	Description	Voltage in AC/AC	Power	Length in cm	Width in cm	Height in cm	Price
227160	IP44 Transformer 60VA	230V/12V	60VA	6,0	10,0	6,3	
Accessory/Included parts: Plug (incl.)							
Primary cable-L: 2 m, Secondary cable-L: 2 m							

IP44 TRANSFORMER 150VA/12V~



Article No.	Description	Voltage in AC/AC	Power	Length in cm	Width in cm	Height in cm	Price
227150	IP44 Transformer 150VA	230V/12V	150VA	8,0	11,0	7,5	
Accessory/Included parts: Plug (incl.)							
Primary cable-L: 2 m, Secondary cable-L: 2 m							

ROUND TRANSFORMER 20VA/12V~

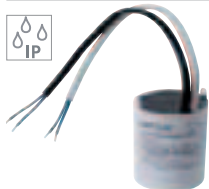

Article No.	Description	Voltage in AC/AC	Power	Specification	Ø in cm	Height in cm	Price
451021	Round transformer 20VA	230V/12V	20VA	ta: 40°C	5,0	6,5	
Primary cable-L: 25 cm, Secondary cable-L: 25 cm. Short-circuit-proof.							

ROUND TRANSFORMER 35VA/12V~



Article No.	Description	Voltage in AC/AC	Power	Specification	Ø in cm	Height in cm	Price
451022	Round transformer 35VA	230V/12V	35VA	ta: 40°C	5,7	8,0	
Primary cable-L: 30 cm, Secondary cable-L: 30 cm. Short-circuit-proof.							

ROUND TRANSFORMER 20VA/24V~



Article No.	Description	Voltage in AC/AC	Power	Specification	Ø in cm	Height in cm	Price
452021	Round transformer 20VA	230V/24V	20VA	ta: 40°C	5,0	6,5	
Primary cable-L: 25 cm, Secondary cable-L: 25 cm. Short-circuit-proof.							

CONVENTIONAL TRANSFORMER 60VA/12V~



Article No.	Description	Voltage in AC/AC	Power	Length in cm	Width in cm	Height in cm	Price
451060	C-transformer 60VA	230V/12V	60VA	6,0	10,0	6,3	
Accessory/Included parts: Primary fuse [incl.]							
Primary cable-L: 25 cm, Secondary cable-L: 25 cm							

CONVENTIONAL TRANSFORMER 105VA/12V~



Article No.	Description	Voltage in AC/AC	Power	Length in cm	Width in cm	Height in cm	Price
451105	C-transformer 105VA	230V/12V	105VA	11,0	7,5	8,0	
Accessory/Included parts: Primary fuse [incl.]							
Primary cable-L: 25 cm, Secondary cable-L: 25 cm							

CONVENTIONAL TRANSFORMER 150VA/12V~



Article No.	Description	Voltage in AC/AC	Power	Length in cm	Width in cm	Height in cm	Price
451150	C-transformer 150VA	230V/12V	150VA	8,0	11,0	8,0	
Accessory/Included parts: Primary fuse [incl.]							
Primary cable-L: 25 cm, Secondary cable-L: 25 cm							

CONVENTIONAL TRANSFORMER 250VA/12V~



Article No.	Description	Voltage in AC/AC	Power	Length in cm	Width in cm	Height in cm	Price
451250	C-transformer 250VA	230V/12V	250VA	9,0	13,0	10,5	
Accessory/Included parts: Primary fuse [incl.]							
Primary cable-L: 25 cm, Secondary cable-L: 25 cm							

CONVENTIONAL TRANSFORMER 300VA/12V~

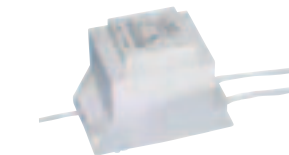

Article No.	Description	Voltage in AC/AC	Power	Length in cm	Width in cm	Height in cm	Price
451301	C-transformer 300VA	230V/12V	300VA	9,0	13,0	11,0	
Accessory/Included parts: Primary fuse [incl.]							
Primary cable-L: 25 cm, Secondary cable-L: 25 cm							

CONVENTIONAL TRANSFORMER 300VA/12V~



Article No.	Description	Voltage in AC/AC	Power	Length in cm	Width in cm	Height in cm	Price
451300	C-transformer 300VA	230V/12V	300VA	9,0	13,0	11,0	
Primary cable-L: 2 m. Secondary connection: 6 outlets, separately protected via plug fuses.							
Max. load per outlet: 50W.							

All illustrated electronic transformers are safety transformers in compact build. They are protected against no-load, short circuit and overload.

The electronic transformers can be operated with standard trailing-edge phase dimmer.

Please pay attention to the manufacturers guidelines.

The secondary cable of an electronic transformer may not exceed 2 meters, otherwise it can cause emission interference.

Electronic transformers are not suitable for rope systems.

FN MINI TRANSFORMER 1 60VA



THE PROFESSIONAL
FN
LIGHT

Article No.	Description	Voltage in AC/AC	Power	Specification	Power factor	Length in cm	Width in cm	Height in cm	Price
461060	FN Mini transformer 1	230V/12V	10-60VA	ta: 50°C	0,98 λ	10,5	3,3	2,2	

Reversible temperature overload switch. Secondary connection: 1 screw clamp terminal.

FN MINI TRANSFORMER 2 60VA



THE PROFESSIONAL
FN
LIGHT

Article No.	Description	Voltage in AC/AC	Power	Specification	Power factor	Length in cm	Width in cm	Height in cm	Price
461062	FN Mini transformer 2	230V/12V	10-60VA	ta: 50°C	0,98 λ	8,5	4,2	2,2	

Reversible temperature overload switch. Secondary connection: 1 screw clamp terminal.

ELECTRONIC TRANSFORMER FN 01 60VA



THE PROFESSIONAL
FN
LIGHT

Article No.	Description	Voltage in AC/AC	Power	Specification	Length in cm	Width in cm	Height in cm	Price
461067	E-Transformer FN 01	230V/12V	20-60VA	ta: 50°C	15,1	3,6	2,7	

Reversible temperature overload switch. Secondary connection: 2 screw clamp terminals.

ELECTRONIC TRANSFORMER FN 02 105VA



THE PROFESSIONAL
FN
LIGHT

Article No.	Description	Voltage in AC/AC	Power	Specification	Length in cm	Width in cm	Height in cm	Price
461107	E-Transformer FN 02	230V/12V	20-105VA	ta: 50°C	16,6	3,9	3,3	

Reversible temperature overload switch. Secondary connection: 3 screw clamp terminals.

ELECTRONIC TRANSFORMER FN 03 150VA



THE PROFESSIONAL
FN
LIGHT

Article No.	Description	Voltage in AC/AC	Power	Specification	Length in cm	Width in cm	Height in cm	Price
461157	E-Transformer FN 03	230V/12V	50-150VA	ta: 50°C	16,6	3,9	3,3	

Reversible temperature overload switch. Secondary connection: 3 screw clamp terminals.

ELECTRONIC TRANSFORMER FN 04 210VA



THE PROFESSIONAL
FN
LIGHT

Article No.	Description	Voltage in AC/AC	Power	Specification	Length in cm	Width in cm	Height in cm	Price
461217	E-Transformer FN 04	230V/12V	50-210VA	ta: 50°C	20,0	4,3	3,9	

Reversible temperature overload switch. Secondary connection: 3 screw clamp terminals.

ELECTR. TRANSFORMER 105VA



Article No.	Description	Voltage in AC/AC	Power	Specification	Length in cm	Width in cm	Height in cm	Price
461310	E-Transformer 105VA	230V/12V	35-105VA	ta: 40°C	16,0	4,5	1,8	

Accessory/Included parts: Strain relief (incl.)

PROFI TRANSFORMER HOLE
70VA



		230~ 12~		10.70 VA								
Article No.	Description	Voltage in AC/AC	Power	Specification	Power factor	Ø in cm	Depth in cm	Price				
461050	Profi transformer Hole	230V/12V	10.70VA	ta: 50°C	0,98 λ	5,5	2,3					
Reversible temperature overload switch. Primary cable length 15 cm/ Secondary cable length 20 cm												

OSRAM MOUSE 70VA



		230~ 12~		20.70 VA	max. 2,5 mm ²							
Article No.	Description	Voltage in AC/AC	Power	Specification	Length in cm	Width in cm	Height in cm	Price				
461075	Osram Mouse 70	230V/12V	20.70VA	ta: 50°C	11,0	5,2	3,3					
Secondary side: 1 screw clamp terminal. Dimmable with leading-edge and trailing-edge phase dimmer.												

OSRAM MOUSE 105VA



		230~ 12~		35.105 VA	max. 2,5 mm ²							
Article No.	Description	Voltage in AC/AC	Power	Specification	Length in cm	Width in cm	Height in cm	Price				
461105	Osram Mouse 105	230V/12V	35.105VA	ta: 45°C	11,0	5,2	3,3					
Secondary side: 2 screw clamp terminal. Dimmable with leading-edge and trailing-edge phase dimmer.												

OSRAM MOUSE 150VA

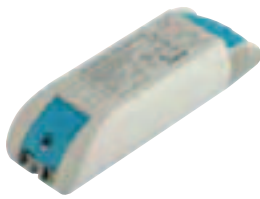

		230~ 12~		50.150 VA	max. 2,5 mm ²							
Article No.	Description	Voltage in AC/AC	Power	Specification	Length in cm	Width in cm	Height in cm	Price				
461155	Osram Mouse 150	230V/12V	50.150VA	ta: 45°C	15,3	5,4	3,6					
Through-wiring. Secondary side: 3 screw clamp terminal. Dimmable with leading-edge and trailing-edge phase dimmer.												

CONNECTION BOX
ROUND



								IP55	
Article No.	Description	Ø in cm	Length in cm	Width in cm	Height in cm	Cable-Ø in mm	Price		
229260	Connection box round	11,5	15,5	15,5	4,6	9.14			
Accessory/Included parts: Clamp (incl.)									
For wiring in outdoor areas. Suitable for driver (464108/-200) see page 635 and 636.									
2 inputs can be used with thin conductions 6-9,5 mm ² .									

CONNECTION BOX IP67



								IP67	
Article No.	Description	Length in cm	Width in cm	Height in cm	Cable-Ø in mm	Price			
229262	Connection box IP67	25,0	4,5	6,0	6-13				

CONNECTION BOX IP68



								IP68	
Article No.	Description	Ø in cm	Length in cm	Cable-Ø in mm	Price				
228730	Connection box IP68 3-pole	2,7	11,5	6-12					
228725	Connection box IP68 5-pole	3,2	13,0	8-17					

TRANSFORMER BOX IP67



								IP67	
Article No.	Description	Length in cm	Width in cm	Height in cm	Cable-Ø in mm	Price			
229261	Transformer box IP67	29,5	4,5	6,0	6-13				
Suitable for electronic components with the max. dimensions: L/W/H: 18,5/4,0/3,5 cm e.g.: LED driver 12W (464110) see page 635.									

ENERGY PACK

230~

2,5

IP54



Article No.	Description	Voltage in AC	Power	Length in cm	Width in cm	Height in cm	Earth spike-L in cm	Price
227000	Energy Pack 4 safety sockets with hinged lid	230V	16A max.	35,0	12,0	12,0	50,0	
Accessory/Included parts: Earth spike (incl.), Mounting screws (incl.) Transformers which are not suitable for outdoor application can be placed in the energy pack. 3 outlets for metrical cable glands according to EN 50262 M 12 (cable-Ø: 2,5-6,5 mm). 1 entry for metrical cable glands according to EN 50262 M 25 (cable-Ø: 9-17 mm).								

8-CHANNEL RADIO TRANSMITTER

12~

0,03



Article No.	Description	Voltage in AC	Length in cm	Width in cm	Height in cm	Range in m outdoor/indoor	Price
410851	8-channel radio transmitter	12V	7,8	4,1	1,4	ca. 50/ca. 30	
Accessory/Included parts: Battery (incl.) For max. two 4-channel receiver (410850 see below). Encoding free selectable.							

4-CHANNEL RECEIVER

230~

0,25

IP54



Article No.	Description	Voltage in AC	Power per channel	Length in cm	Width in cm	Height in cm	Price
410850	4-channel receiver	230V	900W max.	12,1	8,0	5,9	
2 make contacts and 2 changing contacts, encoding free selectable.							

DIMMER MODULE DODI

230~

0,05



Article No.	Description	Voltage in AC	Power	Length in cm	Width in cm	Height in cm	Price
410120	Dimmer module Dodi	230V	see below	5,0	4,0	1,5	
The dimmer module DODI is a leading-edge phase dimmer for the installation in junction boxes. It is suitable for ohmic load of 60-500W and for inductive load of 60-300VA. The dimmer module DODI can not be used in combination with electronic transformers! Incl. soft start for extended operating life of the bulb. The dimmer is controlled via a wall push button.							

DIMMER MODULE RHUN

230~

0,08

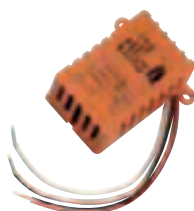

Article No.	Description	Voltage in AC	Power	Length in cm	Width in cm	Height in cm	Price
410130	Dimmer module Rhun	230V	see below	5,0	3,2	2,0	
The dimmer module RHUN is a trailing-edge phase dimmer for the installation in junction boxes. It is suitable for ohmic load of 25-300W and for inductive load of 25-250VA. Incl. soft start for extended operating life of the bulb. The dimmer is controlled via a wall push button.							

CLEAR CABLE

0,51



Article No.	Description	Dimensions	Price
961250	Clear cable insulated 3x 0,75 mm ²	10 m roll	

GX10 SOCKET

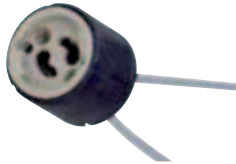

Article No.	Description	Socket	Ø in cm	Length in cm	Line-L in cm	Price
955138	GX10 Socket	GX10	3,1	2,7	20,0	

GU10 SOCKET

230-



Article No.	Description	Socket	Voltage in AC	Line-L in cm	Weight in kg	Price
955135	GU10 Socket 15	GU10	230V	15,0	0,02	
955137	GU10 Socket 60	GU10	230V	60,0	0,035	

G6,35 HALOGEN SOCKET



Article No.	Description	Socket	Ø in cm	Height in cm	Line-L in cm	Price
955000	Halogen socket 15	G6,35	1,7	1,0	15,0	
955020	Halogen socket 60	G6,35	1,7	1,0	60,0	
955030	Halogen socket 120	G6,35	1,7	1,0	120,0	

LOW-VOLTAGE DISTRIBUTION BLOCK 6-FOLD



Article No.	Description	Length in cm	Width in cm	Height in cm	Price
410140	LV-distribution block 6-fold	6,4	2,6	1,5	

A single clamp can be loaded with 50W. The max. load may not exceed 250W!

BULB PLIERS for MR16

Article No.	Material	Price
470640	Stainless steel 304	

BULBS



- The specification of the energy efficiency category for the respective bulb is marked with EEK and the corresponding category value in the table.
- The light technical properties of bulbs are marked with Lumen (lm) for free radiating bulbs and in Candela (cd) for reflector bulbs, the colour rendering property is expressed through the Index Ra. The light colour of the bulbs is measured in K (K=Kelvin). The respective stated value in Kelvin is always an average value from the running production and can therefore vary.
- For the application of IRC or energy-saving bulbs the maximum output of the luminaires and of the standard equivalent bulb must be noted. Tables can be found next to the bulbs.
Example: A lamp with max. 50 standard bulb can only be equipped with a 35W energy-saving bulb!
- All halogen metal halide bulbs, energy-saving bulbs, LED bulbs, fluorescent bulbs and compact fluorescent bulbs must be separately disposed of and do not belong in the domestic rubbish!
- The operation with open lamps without protection glass is only permissible with low-pressure bulbs. Bulbs with this sign  (standard IEC 357) are suitable for the use in lamps without protection glass.
- Halogen bulbs and metal-halide discharge bulbs have a high operating temperature and can cause a heating of the respective lamp housing. The latter can therefore only be touched in cooled condition. Adjustable lamps or lamp heads, which do not have an isolated adjustment handle or where the permissible housing temperature is exceeded at the adjustment point during operation with maximum bulb wattage, must be mounted out of reach of contact. LED Retrofit bulbs are available as low-temperature alternative to most of our halogen bulbs. Suitable solutions can be found in this chapter.

LINE BULBS













HALOGEN BULBS

<p>Pin socket bulbs G4 socket G6,35 socket</p>	 <p>648</p>	<p>G9</p>	 <p>648</p>	<p>R7s</p>	 <p>648</p>	
<p>MR11 / MR16</p>	 <p>649</p>	<p>GU10</p>	 <p>649, 650</p>	<p>QRB111</p>	 <p>650</p>	<p>ES111</p>  <p>650</p>

PROFESSIONAL BULBS

Precise™ ConstantColor™ MR16		Precise™ ConstantColor™ GX10		Britespot GX10		CMH-TC Constant- Color™ SuperMini GU6,5	
	649		651		651		651
CDM-TC G8,5		CDM-T G12		HQI Rx7s			
	651		651		652		
HMI E27		HIT-T E27		PAR E27			
	652		652		652		

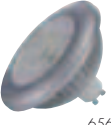
LED BULBS

LED G4 Superflux LED SMD LED Top LED							
	654	654	654				
LED Inserts To convert recessed lamps to long-life and energy-saving LED technology.		LED MR11		LED MR16		LED GU10	
	653		654		654, 655		655
LED QRB 111		LED ES111		LED GX53		LED Module Fortimo Twistable	
	656		656		657		657

ENERGY-SAVING BULBS

EnergySaver G9		EnergySaver GU10			EnergySaver ES111		
	658		658	658		658	
EnergySaver E14			EnergySaver E27				
	659	659		660	659	660	660
EnergySaver G23		EnergySaver G24q		EnergySaver G24d		TCL 2G11	
	660		661		660		661
EnergySaver ring tube GX13 G10q		EnergySaver fluorescent tube T5 T8		EnergySaver GX53			
	661		661		658		



LINE BULB

230~



Article No.	Type	Socket	Wattage	Ø in cm	Length in cm	Colour temperature	Luminous flux	Energy efficiency category	Price
590150	Line bulb matt	S14d	35W	3,0	30,0	2700K	270lm	E EK=F	
590151	Line bulb matt	S14d	60W	3,0	50,0	2700K	420lm	E EK=G	
590152	Line bulb clear	S14d	60W	3,0	50,0	2700K	460lm	E EK=G	

PIN SOCKET LOW-PRESSURE G4

12~

 THE PROFESSIONAL
FN
 LIGHT

Article No.	Type	Socket	Wattage	Colour temperature	Luminous flux	Price
512205	Halogen	G4	5W	2700K	50lm	
512210	Halogen	G4	10W	2700K	120lm	
512220	Halogen	G4	20W	2700K	330lm	

PIN SOCKET LOW-PRESSURE G6,35

12~

 THE PROFESSIONAL
FN
 LIGHT

Article No.	Type	Socket	Wattage	Colour temperature	Luminous flux	Price
512235	Halogen	G6,35	35W	2700K	595lm	
512250	Halogen	G6,35	50W	2700K	900lm	

G9

230~

 THE PROFESSIONAL
FN
 LIGHT

Article No.	Type	Socket	Wattage	EnergySaver \pm	Colour temperature	Luminous flux	Energy efficiency category	Price
519360	Quartz-halogen	G9	42W	\pm 60W	2700K	620lm	E EK=C	

OSRAM HALOPIN ECO "EnergySaver" G9

230~

OSRAM

Article No.	Type	Socket	Wattage	EnergySaver \pm	Colour temperature	Luminous flux	Energy efficiency category	Price
519450	Quartz-halogen	G9	20W	\pm 25W	2700K	200lm	E EK=D	
519451	Quartz-halogen	G9	33W	\pm 40W	2700K	460lm	E EK=C	
519452	Quartz-halogen	G9	48W	\pm 60W	2800K	740lm	E EK=C	

R7s 78mm/118mm "EnergySaver"

230~

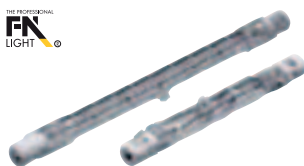
 THE PROFESSIONAL
FN
 LIGHT

Article No.	Type	Socket	Wattage	EnergySaver \pm	Colour temperature	Luminous flux	Energy efficiency category	Price
519206	Quartz-halogen	R7s 78mm	48W	\pm 60W	2700K	750lm	E EK=C	
519215	Quartz-halogen	R7s 78mm	100W	\pm 150W	2700K	1900lm	E EK=C	
519221	Quartz-halogen	R7s 118mm	100W	\pm 150W	2700K	1900lm	E EK=C	
519223	Quartz-halogen	R7s 118mm	200W	\pm 300W	2700K	4000lm	E EK=C	

R7s 78mm/118mm PHILIPS PLUSLINE ES

230~

PHILIPS

Article No.	Type	Socket	Wattage	EnergySaver \pm	Colour temperature	Luminous flux	Energy efficiency category	Price
519230	Quartz-halogen	R7s 78mm	48W	\pm 60W	2900K	750lm	E EK=C	
519231	Quartz-halogen	R7s 78mm	80W	\pm 100W	2900K	1400lm	E EK=C	
519240	Quartz-halogen	R7s 118mm	120W	\pm 150W	2900K	2250lm	E EK=C	
519241	Quartz-halogen	R7s 118mm	160W	\pm 200W	2900K	3100lm	E EK=C	



COOL BEAM MR11 2700K, 20W, 35W

12~

THE PROFESSIONAL
FN
LIGHT

Article No.	Type	Socket	Wattage	Ø in cm	Colour temperature	Luminous intensity	Angel of radiation	Price
533228	Halogen	GU4	20W	3,5	2700K	450cd	FTD 30°	
533330	Halogen	GU4	35W	3,5	2700K	720cd	FTH 30°	

COOL BEAM MR16 2700K, 20W, 35W, 50W

12~

THE PROFESSIONAL
FN
LIGHT

Article No.	Type	Socket	Wattage	Ø in cm	Colour temperature	Luminous intensity	Angel of radiation	Price
535213	Halogen	GU5,3	20W	5,0	2700K	2000cd	ESX 13°	
535240	Halogen	GU5,3	20W	5,0	2700K	450cd	BAB 40°	
535312	Halogen	GU5,3	35W	5,0	2700K	3600cd	FRB 8°	
535338	Halogen	GU5,3	35W	5,0	2700K	810cd	FMW 40°	
535514	Halogen	GU5,3	50W	5,0	2700K	6500cd	EXT 14°	
535527	Halogen	GU5,3	50W	5,0	2700K	2450cd	EXZ 25°	
535540	Halogen	GU5,3	50W	5,0	2700K	1500cd	EXN 40°	
535560	Halogen	GU5,3	50W	5,0	2700K	630cd	FNV 55°	

DIRECT BEAM MR16 CHROME 2700K, 20W, 35W, 50W

12~

THE PROFESSIONAL
FN
LIGHT

Article No.	Type	Socket	Wattage	Ø in cm	Colour temperature	Luminous intensity	Angel of radiation	Price
534240	Halogen	GU5,3	20W	5,0	2700K	450cd	BAB 40°	
534338	Halogen	GU5,3	35W	5,0	2700K	810cd	FMW 40°	
534540	Halogen	GU5,3	50W	5,0	2700K	1500cd	EXN 40°	

With silver reflector rear side.

DIRECT BEAM MR16 2700K, 10W, 20W, 35W, 50W

12~

THE PROFESSIONAL
FN
LIGHT

Article No.	Type	Socket	Wattage	Ø in cm	Colour temperature	Luminous intensity	Angel of radiation	Price
536138	Halogen	GU5,3	10W	5,0	2700K	300cd	- 40°	
536240	Halogen	GU5,3	20W	5,0	2700K	450cd	BAB 40°	
536338	Halogen	GU5,3	35W	5,0	2700K	810cd	FMW 38°	
536540	Halogen	GU5,3	50W	5,0	2700K	1500cd	EXN 40°	

Metal coated for minor heat development at the rear side of the reflector

PRECISE™ CONSTANTCOLOR™ MR16 20W, 35W, 50W

12~



Article No.	Type	Socket	Wattage	Ø in cm	Length in cm	Colour temperature	Luminous intensity	Angel of radiation	Operating life	Price
525212	Halogen	GU5,3	20W	5,1	5,0	2900K	3150cd	15°	5000 h	
525240	Halogen	GU5,3	20W	5,1	5,0	2900K	475cd	40°	5000 h	
525312	Halogen	GU5,3	35W	5,1	5,0	3050K	7500cd	12°	5000 h	
525320	Halogen	GU5,3	35W	5,1	5,0	3000K	3200cd	20°	5000 h	
525340	Halogen	GU5,3	35W	5,1	5,0	3000K	900cd	40°	5000 h	
525514	Halogen	GU5,3	50W	5,1	5,0	3050K	8400cd	14°	6000 h	
525525	Halogen	GU5,3	50W	5,1	5,0	3050K	2900cd	25°	6000 h	
525540	Halogen	GU5,3	50W	5,1	5,0	3050K	1500cd	40°	6000 h	
525555	Halogen	GU5,3	50W	5,1	5,0	3050K	850cd	55°	6000 h	

GU10 2700K, 35W, 50W

230~



SYLVANIA



Article No.	Type	Socket	Wattage	Ø in cm	Colour temperature	Luminous intensity	Angel of radiation	Price
575520	Quartz-Halogen	GU10	35W	5,0	2700K	500cd	25°	
575530	Quartz-Halogen	GU10	50W	5,0	2700K	1100cd	25°	
575535	Quartz-Halogen	GU10	50W	5,0	2700K	500cd	50°	

Reflector alu-coated.

GU10 ECO "EnergySaver" 25W, 35W

230~

THE PROFESSIONAL
FN
LIGHT

Article No.	Type	Socket	Wattage	Ø in cm	Length in cm	Colour temperature	Luminous intensity	Angel of radiation	Price
575360	Quartz-Halogen	GU10	25W	5,0	5,5	2800K	800cd	20°	
575370	Quartz-Halogen	GU10	35W	5,0	5,5	2800K	1200cd	20°	



GU10 2700K, 4000K 35W, 50W

230~

THE PROFESSIONAL
FN
LIGHT

Article No.	Type	Socket	Wattage	Ø in cm	Colour temperature	Luminous intensity	Angel of radiation	Price
575350	Quartz-Halogen	GU10	35W	5,0	4000K	250cd	50°	
575351	Quartz-Halogen	GU10	35W	5,0	2700K	270cd	50°	
575510	Quartz-Halogen	GU10	50W	5,0	2700K	580cd	50°	
575511	Quartz-Halogen	GU10	50W	5,0	4000K	400cd	50°	

Reflector alu-coated.

PAR20 GU10 2700K, 75W

230~

THE PROFESSIONAL
FN
LIGHT

Article No.	Type	Socket	Wattage	Ø in cm	Length in cm	Colour temperature	Luminous intensity	Angel of radiation	Price
575682	Quartz-Halogen	GU10	75W	6,4	6,4	2700K	1060cd	50°	

HALOSPOT111 "EnergySaver" 35W, 50W, 60W

12~

OSRAM



Article No.	Type	Socket	Wattage		Ø in cm	Colour temperature	Luminous intensity	Angel of radiation	Price
545512	Low-pressure halogen	G53	35W	EnergySaver Δ 50W	11,1	3000K	2250cd	6°	
545522	Low-pressure halogen	G53	35W	EnergySaver Δ 50W	11,1	3000K	4500cd	24°	
545751	Low-pressure halogen	G53	50W	EnergySaver Δ 75W	11,1	3000K	3500cd	6°	
545752	Low-pressure halogen	G53	50W	EnergySaver Δ 75W	11,1	3000K	5800cd	24°	
545753	Low-pressure halogen	G53	50W	EnergySaver Δ 75W	11,1	3000K	2000cd	40°	
545108	Low-pressure halogen	G53	60W	EnergySaver Δ 100W	11,1	3000K	4500cd	6°	
545124	Low-pressure halogen	G53	60W	EnergySaver Δ 100W	11,1	3000K	8500cd	24°	
545145	Low-pressure halogen	G53	60W	EnergySaver Δ 100W	11,1	3000K	2800cd	40°	

QRB111 20W, 35W, 50W, 75W

12~

THE PROFESSIONAL
FN
LIGHT

Article No.	Type	Socket	Wattage	Ø in cm	Colour temperature	Luminous intensity	Angel of radiation	Price
543208	Low-pressure halogen	G53	20W	11,1	2700K	4000cd	8°	
543224	Low-pressure halogen	G53	20W	11,1	2700K	900cd	24°	
543245	Low-pressure halogen	G53	20W	11,1	2700K	300cd	45°	
543308	Low-pressure halogen	G53	35W	11,1	2700K	7000cd	8°	
543324	Low-pressure halogen	G53	35W	11,1	2700K	1400cd	24°	
543345	Low-pressure halogen	G53	35W	11,1	2700K	350cd	45°	
543508	Low-pressure halogen	G53	50W	11,1	2700K	12000cd	8°	
543524	Low-pressure halogen	G53	50W	11,1	2700K	2100cd	24°	
543545	Low-pressure halogen	G53	50W	11,1	2700K	700cd	45°	
543708	Low-pressure halogen	G53	75W	11,1	2700K	15000cd	8°	
543724	Low-pressure halogen	G53	75W	11,1	2700K	3000cd	24°	
543745	Low-pressure halogen	G53	75W	11,1	2700K	950cd	45°	

ES111 75W

230~

SYLVANIA



Article No.	Type	Socket	Wattage	Ø in cm	Colour temperature	Luminous intensity	Price
575540	Quartz-Halogen	GU10	75W	11,1	2800K	3500cd	

Reflector alu-coated with shade.

F.N. ES111 50W, 75W

230~

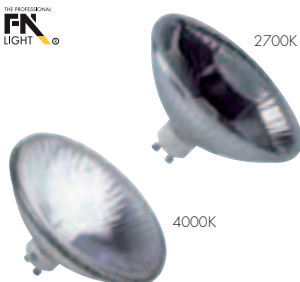
THE PROFESSIONAL
FN
LIGHT

Article No.	Type	Socket	Wattage	Ø in cm	Colour temperature	Luminous intensity	Price
575652	Quartz-Halogen	GU10	50W	11,1	2700K	1300cd	
575672	Quartz-Halogen	GU10	75W	11,1	2700K	2000cd	
Reflector alu-coated with shade.							
575651	Quartz-Halogen	GU10	50W	11,1	4000K	1500cd	
575671	Quartz-Halogen	GU10	75W	11,1	4000K	2500cd	
Reflector alu-coated. Neutral white light in the light cone centre, surrounded by a dichroic effect.							



BRITESPOT ES111 GX10 35W, 70W



SYLVANIA



Article No.	Type	Socket	Wattage	Ø in cm	Colour temperature	Luminous intensity	Colour rendering	Price
506992	Halogen metal halide	GX10	35W	11,1	3000K	10000cd	Ra90	
Reflector alu-coated with shade. Operation only with Electronic ballast HQI/CDM (470360) see page 639.								
506982	Halogen metal halide	GX10	70W	11,1	3000K	20000cd	Ra90	
Reflector alu-coated with shade. Operate only with Electronic ballast HQI/CDM (470370) see page 639.								

CMH MR16 PRECISE™ CONSTANTCOLOR™ GX10 20W/35W



Article No.	Type	Socket	Wattage	Ø in cm	Length in cm	Colour temperature	Luminous intensity	Angel of radiation	Colour rendering	Operating life	Price
507210	HIPAR51	GX10	20W	5,1	5,45	3000K	9000cd	12°	Ra80+	12000 h	
507220	HIPAR51	GX10	20W	5,1	5,45	3000K	2900cd	25°	Ra80+	12000 h	
507240	HIPAR51	GX10	20W	5,1	5,45	3000K	1500cd	40°	Ra80+	12000 h	
Reflector alu-coated. Operation only with electronic ballast HQI/CDM (470350) see page 639.											
507310	HIPAR51	GX10	35W	5,1	5,45	3000K	16000cd	12°	Ra90	10000 h	
507320	HIPAR51	GX10	35W	5,1	5,45	3000K	5500cd	25°	Ra90	10000 h	
507340	HIPAR51	GX10	35W	5,1	5,45	3000K	3000cd	40°	Ra90	10000 h	
507311	HIPAR51	GX10	35W	5,1	5,45	4200K	16000cd	12°	Ra90	12000 h	
507321	HIPAR51	GX10	35W	5,1	5,45	4200K	5500cd	25°	Ra90	12000 h	
507341	HIPAR51	GX10	35W	5,1	5,45	4200K	3000cd	40°	Ra90	12000 h	
Reflector alu-coated. Operation only with electronic ballast HQI/CDM (470360) see page 639.											

HIT-TC Mini GU6,5 20W, 35W



Article No.	Type	Socket	Wattage	Ø in cm	Length in cm	Colour temperature	Luminous flux	Colour rendering	Price
507020	HIT-CE halogen metal halide	GU6,5	20W	1,3	5,2	3000K	1615lm	Ra80+	
507030	HIT-CE halogen metal halide	GU6,5	35W	1,3	5,2	3000K	3300lm	Ra90	
507031	HIT-CE halogen metal halide	GU6,5	35W	1,3	5,2	4200K	3400lm	Ra90	
Ceramics burner for high colour fidelity during the whole operating life.									

CDM-TC G8,5 35W, 70W



PHILIPS



Article No.	Type	Socket	Wattage	Ø in cm	Length in cm	Colour temperature	Luminous flux	Colour rendering	Price
507035	CDM-TC halogen metal halide	G8,5	35W	1,5	8,5	3000K	3400lm	Ra81	
507045	CDM-TC halogen metal halide	G8,5	35W	1,5	8,5	4200K	3200lm	Ra85	
507037	CDM-TC halogen metal halide	G8,5	70W	1,5	8,5	3000K	6200lm	Ra83	
507047	CDM-TC halogen metal halide	G8,5	70W	1,5	8,5	4200K	6200lm	Ra89	

CDM-TC ELITE G8,5 35W, 70W



PHILIPS



Article No.	Type	Socket	Wattage	Ø in cm	Length in cm	Colour temperature	Luminous flux	Colour rendering	Price
507400	CDM-TC Elite halogen metal halide	G8,5	35W	2,0	8,5	3000K	3500lm	Ra90	
507410	CDM-TC Elite halogen metal halide	G8,5	70W	2,0	8,5	3000K	7300lm	Ra91	

CDM-T ELITE G12 35W, 50W, 70W, 150W



PHILIPS



Article No.	Type	Socket	Wattage	Length in cm	Width in cm	Colour temperature	Luminous flux	Colour rendering	Price
507420	CDM-T Elite halogen metal halide	G12	35W	10,3	2,0	3000K	3500lm	Ra90	
507450	CDM-T Elite halogen metal halide	G12	50W	10,3	2,0	3000K	5400lm	Ra90	
507430	CDM-T Elite halogen metal halide	G12	70W	10,3	2,0	3000K	7300lm	Ra91	
507440	CDM-T Elite halogen metal halide	G12	150W	11,0	2,0	3000K	15000lm	Ra90	

CDM-T G12 35W, 70W, 150W



PHILIPS



Article No.	Type	Socket	Wattage	Length in cm	Width in cm	Colour temperature	Luminous flux	Colour rendering	Price
507120	CDM-T halogen metal halide	G12	35W	10,3	2,0	3000K	3300lm	Ra81	
507121	CDM-T halogen metal halide	G12	35W	10,3	2,0	4200K	3300lm	Ra90	
507130	CDM-T halogen metal halide	G12	70W	10,3	2,0	3000K	6600lm	Ra84	
507131	CDM-T halogen metal halide	G12	70W	10,3	2,0	4200K	6600lm	Ra92	
507140	CDM-T halogen metal halide	G12	150W	11,0	2,0	3000K	14000lm	Ra85	
507141	CDM-T halogen metal halide	G12	150W	11,0	2,0	4200K	12700lm	Ra96	
Ceramics burner for high colour fidelity during the whole operating life.									



Rx7s HQI-DE 70W, 150W



OSRAM



Article No.	Type	Socket	Wattage	Length in cm	Colour temperature	Luminous flux	Colour rendering	Price
509070	Halogen metal halide	Rx7s	70W	12,0	3000K	6000lm	Ra75	
509071	Halogen metal halide	Rx7s	70W	12,0	4200K	6500lm	Ra85	
509150	Halogen metal halide	Rx7s	150W	13,5	3000K	12000lm	Ra75	
509151	Halogen metal halide	Rx7s	150W	13,5	4200K	12500lm	Ra85	

Rx7s HQI COLOUR 70W, 150W



Article No.	Type	Socket	Wattage	Length in cm	Light colour	Luminous flux	Price
510075	HQI:LM halogen metal halide	Rx7s	70W	12,0	grün	3600lm	
510077	HQI:LM halogen metal halide	Rx7s	70W	12,0	blue	1700lm	
510155	HQI:LM halogen metal halide	Rx7s	150W	13,5	grün	9500lm	
510157	HQI:LM halogen metal halide	Rx7s	150W	13,5	blue	3000lm	

Rx7s CDM-TD 70W, 150W



PHILIPS



Article No.	Type	Socket	Wattage	Length in cm	Colour temperature	Luminous flux	Colour rendering	Price
507070	CDM-TD halogen metal halide	Rx7s	70W	12,0	3000K	6500lm	Ra82	
507071	CDM-TD halogen metal halide	Rx7s	70W	12,0	4200K	6000lm	Ra92	
507150	CDM-TD halogen metal halide	Rx7s	150W	13,5	3000K	13250lm	Ra88	
507151	CDM-TD halogen metal halide	Rx7s	150W	13,5	4200K	14200lm	Ra96	

Ceramics burner for high colour fidelity during the whole operating life.

HIT-E E27 70W, 150W / HQI-E E40 250W, 400W



SYLVANIA



Article No.	Type	Socket	Wattage	Ø in cm	Length in cm	Colour temperature	Luminous flux	Colour rendering	Price
508170	HQI-E halogen metal halide	E27	70W	5,4	13,8	3000K	-	Ra70-80	
508171	HQI-E halogen metal halide	E27	70W	5,4	13,8	3800K	-	Ra70-80	
509170	HQI-E halogen metal halide	E27	150W	5,4	13,8	3000K	12500lm	Ra70-80	
509171	HQI-E halogen metal halide	E27	150W	5,4	13,8	3800K	12500lm	Ra70-80	
Operation is only possible with ballasts.									
509180	HQI-E halogen metal halide	E40	250W	9,0	22,5	4200K	20000lm	Ra70-80	
509191	HQI-E halogen metal halide	E40	400W	9,0	22,5	4200K	40000lm	Ra70-80	
Operation is only possible with ballasts.									

HIT-T E40 400W



Article No.	Type	Socket	Wattage	Ø in cm	Length in cm	Light colour	Colour temperature	Luminous flux	Colour rendering	Price
510400	HIT-T halogen metal halide	E40	400W	4,5	26,5	cold white	4200K	42000lm	Ra70+	
Operation is only possible with ballasts.										

HMLI E27 160W, 250W



OSRAM



Article No.	Type	Socket	Wattage	Ø in cm	Length in cm	Colour temperature	Luminous flux	Colour rendering	Price
506160	Mixed light bulb	E27	160W	7,4	170	3600K	3100lm	Ra62	
506250	Mixed light bulb	E27	250W	7,4	170	3800K	5600lm	Ra60	

HMLI-bulbs are operated with mains voltage without a ballast. They are equipped with a tungsten filament which is in line with a mercury vapour tube.

PAR20 E27 50W, 75W / PAR30 E27 75W, 150W / PAR38 E27 80W

THE PROFESSIONAL
FN
LIGHT

Article No.	Type	Socket	Wattage	Ø in cm	Length in cm	Colour temperature	Luminous intensity	Angel of radiation	Operating life	Price
519725	Halogen-Reflector PAR20	E27	50W	6,5	8,2	-	3300cd	24°	1500 h	
519727	Halogen-Reflector PAR20	E27	75W	6,5	8,2	-	5500cd	24°	1500 h	
519737	Halogen-Reflector PAR30	E27	75W	9,5	9,3	-	7000cd	24°	2000 h	
519739	Halogen-Reflector PAR30	E27	150W	9,5	9,3	-	11000cd	24°	2000 h	
519760	Halogen-Reflector PAR38	E27	80W	12,4	13,6	2500K	-	30°	2000 h	



LED-INSERTS

To convert downlights to long-life and energy-saving LED technology.

The LED-inserts 3x 1W and 3x 3W can be used in most of our GU10 downlights instead of standard GU10 halogene bulbs. The LED-insert will be fixed in the lamp like a bulb. The standard GU10 socket will be omitted. The LED-insert can be connected directly with the driver and this one directly to the mains.

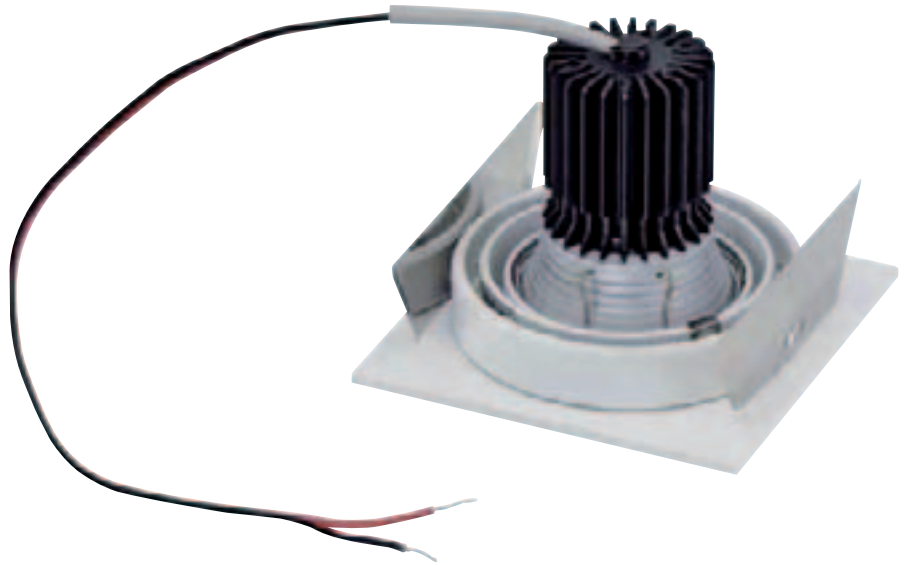







The LED-inserts are available as single components or as relamping kit incl. driver.



LED 50mm INSERT 3x 3W 700mA  3 pce.  0,09 

Article No.	Type	Socket	Wattage	Ø in cm	Length in cm	LED colour temperature	Luminous flux	Angel of radiation	Price
551121	PowerLED	50mm Insert	9W	5,0	6,2	5500K	390lm	15°	
551122	PowerLED	50mm Insert	9W	5,0	6,2	3250K	320lm	15°	
551131	PowerLED	50mm Insert	9W	5,0	6,2	5500K	350lm	35°	
551132	PowerLED	50mm Insert	9W	5,0	6,2	3250K	290lm	35°	

Cable-L: 30 cm. Operation only with 700mA driver. LED driver (excl.)

ACCESSORY for LED 50mm inserts         



LED Driver 9W, 700mA
 Output: 9W
 ta: 50°C, tc: 80°C
 L/W/H: 9/4/2,3 cm
 For 3x 3W LED or
 1x LED insert 3x 3W.

Art. Nr.:
464302

LED RELAMPING KIT LED 50mm inserts incl. driver as set       



Article No.	Set consisting of	Weight in kg	Price
551221	700mA driver incl. LED 50mm insert 3x 3W, 5500K, 15°	0,15	
551222	700mA driver incl. LED 50mm insert 3x 3W, 3250K, 15°	0,15	
551231	700mA driver incl. LED 50mm insert 3x 3W, 5500K, 35°	0,15	
551232	700mA driver incl. LED 50mm insert 3x 3W, 3250K, 35°	0,15	



G4 LED SUPER FLUX

12~ 1 pce. 0,007



Article No.	Type	Socket	Wattage	Ø in cm	Length in cm	LED colour	Luminous flux	Angel of radiation	Price
550311	SuperfluxLED	G4	0,2W	0,9	1,8	white	2,6lm	60°	
550312	SuperfluxLED	G4	0,2W	0,9	1,8	warm white	2,7lm	60°	
550317	SuperfluxLED	G4	0,2W	0,9	1,8	blue	0,8lm	100°	

Operation only with conventional transformer. Pay attention to the usage rate of the transformer.

G4 HIGH POWER LED

12~ 1 pce. 0,005



Article No.	Type	Socket	Wattage	Ø in cm	Length in cm	LED Colour	Luminous flux	Angel of radiation	Price
550911	SMD LED	G4	0,4W	1,0	2,5	white	15lm	120°	
550912	SMD LED	G4	0,4W	1,0	2,5	warm white	15lm	120°	

Operation only with conventional transformer. Pay attention to the usage rate of the transformer.

OCTAGON LED MODULE 12V

12~ 9 pce. 120° 0,01

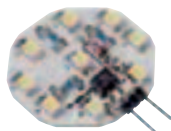

Article No.	Type	Socket	Wattage	Length in cm	Width in cm	Height in cm	LED colour	Luminous flux	Price
550251	TopLED	G4	1,5W	3,0	3,9	0,4	white	21lm	
550252	TopLED	G4	1,5W	3,0	3,9	0,4	warm white	19lm	

To convert suitable lamps to LED technology (see product description).

Operation only with conventional transformer. Pay attention to the usage rate of the transformer.

G9 SMD LED 3,5W

230~ 60 pce. ta 40° 0,03



Article No.	Type	Socket	Wattage	Ø in cm	Height in cm	LED colour	Colour temperature	Luminous flux	Colour rendering	Energy efficiency category	Price
551362	LED	G9	3,5W	3,0	7,2	warm white	3000K	270lm	Ra73	EEL=A	

Power consumption: 30mA.

MASTER LED SPOT MR11 4W

12~ 2 pce. 0,03



PHILIPS



Article No.	Type	Socket	Wattage	Ø in cm	Length in cm	Colour temperature	Luminous intensity	Angel of radiation	Colour rendering	Price
560091	PowerLED	G4	4W	3,5	4	4000K	700cd	24°	Ra80	
560092	PowerLED	G4	4W	3,5	4	2700K	580cd	24°	Ra80	
560093	PowerLED	G4	4W	3,5	4	3000K	590cd	36°	Ra80	

Power consumption: 700mA. Only suitable for open, ventilated lamps. Operation with electronic and conventional transformer!

LED MR16

12~ 18 pce. 25° 0,04

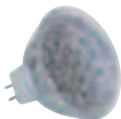

Article No.	Type	Socket	Wattage	Ø in cm	Length in cm	LED Colour	Luminous flux	Price
550801	LED	GU5,3	2,4W	5,0	5,0	white	57lm	
550802	LED	GU5,3	2,4W	5,0	5,0	warm white	46lm	

Operation only with conventional transformer. Pay attention to the usage rate of the transformer.

MASTER LED SPOT MR16 4W

12~ 2 pce. 0,03



PHILIPS



Article No.	Type	Socket	Wattage	Ø in cm	Length in cm	Colour temperature	Luminous intensity	Angel of radiation	Colour rendering	Price
560041	PowerLED	GU5,3	4W	5,0	4,6	2700K	700cd	24°	Ra80+	
560042	PowerLED	GU5,3	4W	5,0	4,6	2700K	470cd	36°	Ra80+	
560043	PowerLED	GU5,3	4W	5,0	4,6	3000K	720cd	24°	Ra80+	
560044	PowerLED	GU5,3	4W	5,0	4,6	3000K	500cd	36°	Ra80+	

Power consumption: 670mA. Operation with electronic and conventional transformer!



MR16 LED 5W

12~ PlanarLED 1 pce. ta 40° 0,03



Article No.	Type	Socket	Wattage	Ø in cm	Length in cm	LED colour	Colour temperature	Luminous flux	Angel of radiation	Colour rendering	Price
551301	COB LED	GU5,3	4,2W	5,0	4,9	white	5500K-6000K	285lm	30°	Ra70	
551302	COB LED	GU5,3	4,2W	5,0	4,9	warm white	2800K-3000K	285lm	30°	Ra80	
551311	COB LED	GU5,3	4,2W	5,0	4,9	white	5500K-6000K	285lm	60°	Ra70	
551312	COB LED	GU5,3	4,2W	5,0	4,9	warm white	2800K-3000K	285lm	60°	Ra80	

Power consumption: 535mA. Operation only with conventional transformer.

LED GU10

230~ LED 18 pce. 25° 0,04



Article No.	Type	Socket	Wattage	Ø in cm	Length in cm	LED Colour	Luminous flux	Price
550811	LED	GU10	2,5W	5,0	5,65	white	50lm	
550812	LED	GU10	2,5W	5,0	5,65	warm white	40lm	

GU10 LED 5W

230~ PlanarLED 1 pce. ta 40° 0,04



Article No.	Type	Socket	Wattage	Ø in cm	Length in cm	LED Colour	Colour temperature	Luminous flux	Angel of radiation	Colour rendering	Price
551321	COB LED	GU10	5,6W	5,0	5,7	white	5000K-5300K	330lm	30°	Ra70	
551322	COB LED	GU10	5,6W	5,0	5,7	warm white	2700K-3000K	330lm	30°	Ra80	
551331	COB LED	GU10	5,6W	5,0	5,7	white	5000K-5300K	320lm	60°	Ra70	
551332	COB LED	GU10	5,6W	5,0	5,7	warm white	2700K-3000K	300lm	60°	Ra80	

LED SPOT GU10 4W

230~ LED 1 pce. 0,04



PHILIPS



Article No.	Type	Socket	Wattage	Ø in cm	Length in cm	Colour temperature	Luminous intensity	Luminous flux	Angel of radiation	Colour rendering	Price
560084	PowerLED	GU10	4W	5,0	5,5	3000K	300cd	165lm	36°	Ra80	

MASTER LED GU10 4W dimmable

230~ LED 1 pce. 0,05



PHILIPS



Article No.	Type	Socket	Wattage	Ø in cm	Length in cm	Colour temperature	Luminous intensity	Luminous flux	Angel of radiation	Colour rendering	Price
560011	PowerLED	GU10	4W	5,0	5,7	2700K	700cd	180lm	25°	Ra80+	
560012	PowerLED	GU10	4W	5,0	5,7	2700K	350cd	180lm	40°	Ra80+	
560013	PowerLED	GU10	4W	5,0	5,7	3000K	700cd	180lm	25°	Ra80+	
560014	PowerLED	GU10	4W	5,0	5,7	3000K	350cd	180lm	40°	Ra80+	

MASTER LED GU10 6W dimmable

230~ LED 1 pce. ta 45° 0,05



PHILIPS



Article No.	Type	Socket	Wattage	Ø in cm	Length in cm	Colour temperature	Luminous intensity	Luminous flux	Angel of radiation	Colour rendering	Price
560101	PowerLED	GU10	6W	5,0	5,5	2700K	1000cd	300lm	25°	Ra80	
560102	PowerLED	GU10	6W	5,0	5,5	2700K	600cd	300lm	40°	Ra80	
560103	PowerLED	GU10	6W	5,0	5,5	3000K	1100cd	320lm	25°	Ra80	
560104	PowerLED	GU10	6W	5,0	5,5	3000K	600cd	320lm	40°	Ra80	



POWERLED QRB111

12~ 6 pce. 40° 0,18 23000



Article No.	Type	Socket	Wattage	Ø in cm	Length in cm	LED Colour	Luminous flux	Price
550131	PowerLED	G53	10W	11,1	5,8	white	590lm	
550132	PowerLED	G53	10W	11,1	5,8	warm white	430lm	

Power consumption: 1100mA.

Operation with electronic or conventional transformer. Pay attention to the usage rate of the transformer. Not usable with transformers (461060/-2/-1107)

QRB111 LED 10W

12~ 6 pce. 25° 0,15 23000 to 40°



Article No.	Type	Socket	Wattage	Ø in cm	Length in cm	Colour temperature	Luminous flux	Price
551382	PowerLED	G53	10,4W	11,1	6,3	2950K	690lm	

Power consumption: 1273mA.

PARATHOM PRO LED QRB111 12W dimmable

12~ 7 pce. 24° 43000 to 40° 0,17



Article No.	Type	Socket	Wattage	Ø in cm	Length in cm	Colour temperature	Luminous intensity	Luminous flux	Colour rendering	Price
570001	PowerLED	G53	12W	11,1	5,85	2700K	3600cd	500lm	Ra85	
570003	PowerLED	G53	12W	11,1	5,85	3000K	4000cd	550lm	Ra85	

Power consumption: 1A.

Operation with electronic or conventional transformer. Pay attention to the usage rate of the transformer.

LED ES111

230~ 57 pce. 30° 10000 0,25



Article No.	Type	Socket	Wattage	Ø in cm	Length in cm	LED colour	Luminous flux	Price
550111	LED	GU10	3,8W	11,1	6,5	white	190lm	
550112	LED	GU10	3,8W	11,1	6,5	warm white	185lm	

POWERLED ES111

230~ 6 pce. 12000 0,22



Article No.	Type	Socket	Wattage	Ø in cm	Length in cm	LED colour	Luminous flux	Angel of radiation	Price
550341	PowerLED	GU10	10W	11,0	6,9	white	580lm	25°	
550342	PowerLED	GU10	10W	11,0	6,9	warm white	460lm	25°	
550351	PowerLED	GU10	10W	11,0	6,9	white	590lm	40°	
550352	PowerLED	GU10	10W	11,0	6,9	warm white	460lm	40°	

DOMELED ES111

230~ 6 pce. 23000 0,27



Article No.	Type	Socket	Wattage	Ø in cm	Length in cm	LED colour	Luminous flux	Angel of radiation	Price
550381	PowerLED	GU10	9W	11,0	7,8	white	478lm	25°	
550382	PowerLED	GU10	9W	11,0	7,8	warm white	333lm	25°	
550391	PowerLED	GU10	9W	11,0	7,8	white	241lm	60°	
550392	PowerLED	GU10	9W	11,0	7,8	warm white	176lm	60°	



E27 LED 10W

230~



1 pce.



Article No.	Type	Socket	Wattage	Ø in cm	Length in cm	Colour temperature	Luminous flux	Colour rendering	Energy efficiency category	Price
551342	SMD LED	E27	10W	6,8	12,2	2800K-3000K	700lm	Ra82	EEK=A	
Power consumption: 56mA.										

SMD LED

230~



29 pce.

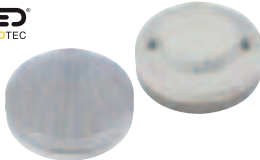

Article No.	Type	Socket	Wattage	Ø in cm	Length in cm	LED colour	Luminous flux	Colour rendering	Price	
551371	LED	GX53	2,8W	7,5	2,9	white	195lm	Ra70		
551372	LED	GX53	2,8W	7,5	2,9	warm white	185lm	Ra70		
Power consumption: 36mA.										

POWERLED GX53

230~



3 pce.



Article No.	Type	Socket	Wattage	Ø in cm	Length in cm	LED colour	Colour temperature	Luminous flux	Price
550091	PowerLED	GX53	3x 1,4W	7,5	3,5	white	5500K	260lm	
550092	PowerLED	GX53	3x 1,4W	7,5	3,5	warm white	3250K	200lm	
550097	PowerLED	GX53	3x 1,4W	7,5	3,5	blue	-	-	

FORTIMO LED TWISTABLE MODULE

230~



1 Module



Article No.	Type	Wattage	Ø in cm	Length in cm	LED Colour	Colour temperature	Luminous flux	Colour rendering	Price
560201	PowerLED	18W	7,7	4,0	white	4000K	1100lm	Ra80	
560202	PowerLED	20W	7,7	4,0	warm white	3000K	1100lm	Ra80	

For use in: 162441/-4, 162451/-4, 165204, 230160/4



MICROLYNX 6W

230~

SYLVANIA

Article No.	Type	Socket	Wattage	Ø in cm	Length in cm	Colour temperature	Luminous flux	Energy efficiency category	Price
508421	Energy-saving bulb	GX53	6W	7,5	2,1	3000K	220lm	EEK=B	
508422	Energy-saving bulb	GX53	6W	7,5	2,1	4000K	220lm	EEK=B	

Direct current operation possible!

GX53 9W

230~



Article No.	Type	Socket	Wattage	Ø in cm	Length in cm	Colour temperature	Luminous flux	Price
508860	Energy-saving bulb	GX53	9W	7,5	2,7	2700K	260lm	
508861	Energy-saving bulb	GX53	9W	7,5	2,7	4200K	260lm	

Direct current operation **not** possible!

ENERGY-SAVING BULB G9 9W

230~



Article No.	Type	Socket	Wattage	Ø in cm	Length in cm	Colour temperature	Luminous flux	Energy efficiency category	Price
508940	Energy-saving bulb	G9	9W	3,3	8,0	2700K	405lm	EEK=A	
508941	Energy-saving bulb	G9	9W	3,3	8,0	4000K	405lm	EEK=A	

ENERGY-SAVING BULB GU10 9W spiral form

230~



Article No.	Type	Socket	Wattage	Ø in cm	Length in cm	Colour temperature	Luminous flux	Energy efficiency category	Price
508980	Energy-saving bulb	GU10	9W	3,1	9,0	2700K	420lm	EEK=A	
508981	Energy-saving bulb	GU10	9W	3,1	9,0	4000K	420lm	EEK=A	

Because of the housing dimensions of this bulb, it cannot be used in all GU10 lamps. Information can be obtained from our sales team.

ENERGY-SAVING BULB GU10 9W, 11W

230~



Article No.	Type	Socket	Wattage	Ø in cm	Length in cm	Colour temperature	Luminous flux	Price
508910	Energy-saving bulb	GU10	9W	5,0	7,6	2700K	200lm	
508911	Energy-saving bulb	GU10	9W	5,0	7,6	4000K	200lm	
508920	Energy-saving bulb	GU10	11W	5,0	7,6	2700K	220lm	
508921	Energy-saving bulb	GU10	11W	5,0	7,6	4000K	220lm	

Because of the housing dimensions of this bulb, it cannot be used in all GU10 lamps. Information can be obtained from our sales team.

SHOPLIGHT ES111 11W

230~



Article No.	Type	Socket	Wattage	Ø in cm	Length in cm	Colour temperature	Luminous intensity	Colour rendering	Price
508560	Energy-saving bulb	GU10	11W	11,1	8,3	3000K	400cd	Ra80	
508561	Energy-saving bulb	GU10	11W	11,1	8,3	4000K	400cd	Ra80	

Reflector bulb.



ENERGY-SAVING BULB E14 7W, 9W, 11W

230~



Size comparison

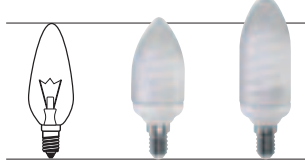

Article No.	Type	Socket	Wattage	Ø in cm	Length in cm	Colour temperature	Luminous flux	Energy efficiency category	Price
508800	Energy-saving bulb	E14	7W	3,6	11,0	2700K	285lm	EEK=A	
508801	Energy-saving bulb	E14	7W	3,6	11,0	4200K	285lm	EEK=A	
508840	Energy-saving bulb	E14	9W	3,8	11,7	2700K	420lm	EEK=A	
508841	Energy-saving bulb	E14	9W	3,8	11,7	4000K	420lm	EEK=A	
508810	Energy-saving bulb	E14	11W	3,8	12,0	2700K	530lm	EEK=A	
508811	Energy-saving bulb	E14	11W	3,8	12,0	4200K	530lm	EEK=A	

MINILYNX E14 11W

230~

**SYLVANIA**

Article No.	Type	Socket	Wattage	Ø in cm	Length in cm	Colour temperature	Luminous flux	Energy efficiency category	Price
508630	Energy-saving bulb	E14	11W	4,8	9,6	2700K	575lm	EEK=A	
508631	Energy-saving bulb	E14	11W	4,8	9,6	4000K	575lm	EEK=A	

MINILYNX E27 11W, 15W, 20W, 23W

230~

**SYLVANIA**

Article No.	Type	Socket	Wattage	Ø in cm	Length in cm	Colour temperature	Luminous flux	Energy efficiency category	Price
508730	Energy-saving bulb	E27	11W	4,8	9,6	2700K	575lm	EEK=A	
508731	Energy-saving bulb	E27	11W	4,8	9,6	4000K	575lm	EEK=A	
508740	Energy-saving bulb	E27	15W	4,8	11,6	2700K	850lm	EEK=A	
508741	Energy-saving bulb	E27	15W	4,8	11,6	4000K	850lm	EEK=A	
508760	Energy-saving bulb	E27	20W	4,8	13,6	2700K	1200lm	EEK=A	
508761	Energy-saving bulb	E27	20W	4,8	13,6	4000K	1200lm	EEK=A	
508770	Energy-saving bulb	E27	23W	4,8	14,8	2700K	1350lm	EEK=A	
508771	Energy-saving bulb	E27	23W	4,8	14,8	4000K	1350lm	EEK=A	

ELD E27 11W

230~



Article No.	Type	Socket	Wattage	Ø in cm	Length in cm	Colour temperature	Luminous flux	Colour rendering	Energy efficiency category	Price
508211	Energy-saving bulb	E27	11W	4,4	12,4	2700K	580lm	Ra80+	EEK=A	

ELD E27 15W

230~

**SYLVANIA**

Article No.	Type	Socket	Wattage	Ø in cm	Length in cm	Colour temperature	Luminous flux	Colour rendering	Energy efficiency category	Price
508415	ELD 2-fold Energy-saving bulb	E27	15W	4,5	17,0	2700K	900lm	Ra80-90	EEK=A	
508515	ELD 2-fold Energy-saving bulb	E27	15W	4,5	17,0	4000K	900lm	Ra80-90	EEK=A	

MASTER STAIRWAY ELT E27 15W, 20W

230~

**PHILIPS**

Article No.	Type	Socket	Wattage	Ø in cm	Length in cm	Colour temperature	Luminous flux	Power consumption	Colour rendering	Energy efficiency category	Weight in kg	Price
508600	ELT 3-fold ESL	E27	15W	4,8	12,6	2700K	850lm	120mA	Ra82	EEK=A	0,08	
508610	ELT 3-fold ESL	E27	20W	4,8	13,7	2700K	1230lm	145mA	Ra82	EEK=A	0,09	

Also applicable for motion detector! Ignition time: 1 Sec., Starting time: 20 Sec., Mercury content: < 1,41 mg.

ELT E27 21W, 24W

230~

**OSRAM**

Article No.	Type	Socket	Wattage	Ø in cm	Length in cm	Colour temperature	Luminous flux	Energy efficiency category	Price
508416	ELT 3-fold Energy-saving bulb	E27	21W	4,5	14,5	2500K	1230lm	EEK=A	
508417	ELT 3-fold Energy-saving bulb	E27	24W	5,2	17,3	2500K	1500lm	EEK=A	



ENERGY-SAVING BULB E27 11W, 15W, 23W

230~

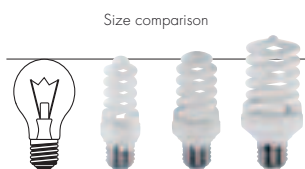

Article No.	Type	Socket	Wattage	Ø in cm	Length in cm	Colour temperature	Luminous flux	Energy efficiency category	Price
508950	Energy-saving bulb	E27	11W	3,5	10,5	2700K	530lm	EEK=A	
508951	Energy-saving bulb	E27	11W	3,5	10,5	4000K	530lm	EEK=A	
508960	Energy-saving bulb	E27	15W	4,3	11,0	2700K	800lm	EEK=A	
508961	Energy-saving bulb	E27	15W	4,3	11,0	4000K	800lm	EEK=A	
508970	Energy-saving bulb	E27	23W	5,2	12,1	2700K	1350lm	EEK=A	
508971	Energy-saving bulb	E27	23W	5,2	12,1	4000K	1350lm	EEK=A	

ENERGY-SAVING BULB E27, 20W spiral form, dimmable

230~



Article No.	Type	Socket	Wattage	Ø in cm	Length in cm	Colour temperature	Luminous flux	Energy efficiency category	Price
508870	Energy-saving bulb	E27	20W	5,9	13,6	2700K	1350lm	EEK=A	

Dimmable with trailing-edge phase dimmer.

ENERGY-SAVING BULB E27 15W, 20W

230~



Article No.	Type	Socket	Wattage	Ø in cm	Length in cm	Colour temperature	Luminous flux	Energy efficiency category	Price
508820	Energy-saving bulb	E27	15W	6,0	12,8	2700K	800lm	EEK=A	
508821	Energy-saving bulb	E27	15W	6,0	12,8	4200K	800lm	EEK=A	
508830	Energy-saving bulb	E27	20W	6,6	14,8	2700K	1150lm	EEK=A	
508831	Energy-saving bulb	E27	20W	6,6	14,8	4200K	1150lm	EEK=A	

ENERGY-SAVING BULB PAR38 E27 23W

230~

PHILIPS



Article No.	Type	Socket	Wattage	Ø in cm	Length in cm	Colour temperature	Luminous intensity	Luminous flux	Colour rendering	Energy efficiency category	Price
519620	Energy-saving bulb	E27	23W	12,2	14	2700K	400cd	1250lm	Ra80	EEK=A	

Ignition time: 0,3 Sek., Mercury content: < 2,0 mg.

TC-S G23 9W, 11W



Article No.	Type	Socket	Wattage	Ø in cm	Length in cm	Colour temperature	Luminous flux	Energy efficiency category	Price
508209	TC-S 2-Pin Energy-saving bulb	G23	9W	3,2	16,5	2700K	600lm	EEK=A	
508309	TC-S 2-Pin Energy-saving bulb	G23	9W	3,2	16,5	4000K	600lm	EEK=A	
508310	TC-S 2-Pin Energy-saving bulb	G23	11W	3,2	23,5	2700K	900lm	EEK=A	
508311	TC-S 2-Pin Energy-saving bulb	G23	11W	3,2	23,5	4000K	900lm	EEK=A	

TC-D G24d-1 13W / TC-D G24d-2 18W / TC-D G24d-3 26W



Article No.	Type	Socket	Wattage	Ø in cm	Length in cm	Colour temperature	Luminous flux	Energy efficiency category	Price
508213	TC-D 2-Pin Energy-saving bulb	G24d-1	13W	4,1	13,7	2700K	900lm	EEK=A	
508313	TC-D 2-Pin Energy-saving bulb	G24d-1	13W	4,1	13,7	4000K	900lm	EEK=A	
508218	TC-D 2-Pin Energy-saving bulb	G24d-2	18W	4,1	15,1	2700K	1200lm	EEK=B	
508318	TC-D 2-Pin Energy-saving bulb	G24d-2	18W	4,1	15,1	4000K	1200lm	EEK=B	
508226	TC-D 2-Pin Energy-saving bulb	G24d-3	26W	4,1	17,0	2700K	1800lm	EEK=B	
508326	TC-D 2-Pin Energy-saving bulb	G24d-3	26W	4,1	17,0	4000K	1800lm	EEK=B	



TC-DE G24q-1 13W / TC-DE G24q-2 18W / TC-DE G24q-3 26W



Article No.	Type	Socket	Wattage	Ø in cm	Length in cm	Colour temperature	Luminous flux	Energy efficiency category	Price
508212	TC-DE 4-Pin Energy-saving bulb	G24q-1	13W	4,1	12,9	3000K	900lm	EEK=A	
508312	TC-DE 4-Pin Energy-saving bulb	G24q-1	13W	4,1	12,9	4000K	900lm	EEK=A	
508220	TC-DE 4-Pin Energy-saving bulb	G24q-2	18W	4,1	14,6	3000K	1200lm	EEK=B	
508320	TC-DE 4-Pin Energy-saving bulb	G24q-2	18W	4,1	14,6	4000K	1200lm	EEK=B	
508222	TC-DE 4-Pin Energy-saving bulb	G24q-3	26W	4,1	16,2	3000K	1800lm	EEK=B	
508322	TC-DE 4-Pin Energy-saving bulb	G24q-3	26W	4,1	16,2	4000K	1800lm	EEK=B	

TC-L 2G11 18W, 24W, 36W, 55W

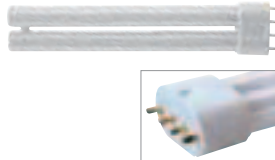

Article No.	Type	Socket	Wattage	Length in cm	Width in cm	Height in cm	Colour temperature	Luminous flux	Energy efficiency category	Operating life	Price
508460	TC-L 2G11 4-Pin Energy-saving bulb	2G11	18W	21,2	4,3	2,4	2700K	1200lm	EEK=A	10000 h	
508461	TC-L 2G11 4-Pin Energy-saving bulb	2G11	18W	21,2	4,3	2,4	4000K	1200lm	EEK=A	10000 h	
508440	TC-L 2G11 4-Pin Energy-saving bulb	2G11	24W	32,0	4,3	2,4	2700K	1800lm	EEK=A	10000 h	
508441	TC-L 2G11 4-Pin Energy-saving bulb	2G11	24W	32,0	4,3	2,4	4000K	1800lm	EEK=A	10000 h	
590144	TC-L 2G11 4-Pin Energy-saving bulb	2G11	36W	41,5	4,3	2,4	2700K	2900lm	EEK=A	12000 h	
590145	TC-L 2G11 4-Pin Energy-saving bulb	2G11	36W	41,5	4,3	2,4	4000K	2900lm	EEK=A	12000 h	
508450	TC-L 2G11 4-Pin Energy-saving bulb	2G11	55W	53,3	4,3	2,4	2700K	4800lm	EEK=A	10000 h	
508451	TC-L 2G11 4-Pin Energy-saving bulb	2G11	55W	53,3	4,3	2,4	4000K	4800lm	EEK=A	10000 h	

RING TUBE T5 22W, 40W / T8 32W, 40W

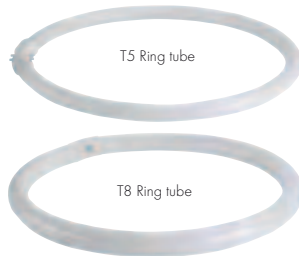
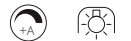

Article No.	Type	Socket	Wattage	Ø in cm	Colour temperature	Luminous flux	Colour rendering	Energy efficiency category	Operating life	Price
548220	Energy-saving bulb	2GX13	22W	22,5	3000K	1900lm	Ra85	EEK=A	12000 h	
548221	Energy-saving bulb	2GX13	22W	22,5	4000K	1900lm	Ra85	EEK=A	12000 h	
548240	Energy-saving bulb	2GX13	40W	30,0	3000K	3400lm	Ra85	EEK=A	12000 h	
548241	Energy-saving bulb	2GX13	40W	30,0	4000K	3400lm	Ra85	EEK=A	12000 h	
548230	Energy-saving bulb	G10q	32W	30,0	3000K	2375lm	Ra85	EEK=B	9000 h	
548231	Energy-saving bulb	G10q	32W	30,0	4000K	2375lm	Ra85	EEK=B	9000 h	
548210	Energy-saving bulb	G10q	40W	40,6	3000K	3200lm	Ra85	EEK=B	9000 h	
548211	Energy-saving bulb	G10q	40W	40,6	4000K	3200lm	Ra85	EEK=B	9000 h	

T5 8W, 13W, 14W, 21W, 24W, 28W, 35W, 39W, 54W / T5 COLOUR 21W / T8 18W / T8 COLOUR 36W



Article No.	Type	Socket	Wattage	Ø in cm	Length in cm	Light colour	Colour temperature	Luminous flux	Colour rendering	Operating life	Price/Stück
591293	Energy-saving bulb	G5	8W	1,6	28,8	warm white	3500K	400lm	-	-	
591294	Energy-saving bulb	G5	8W	1,6	28,8	cold white	4300K	400lm	-	-	
591295	Energy-saving bulb	G5	13W	1,6	53,0	warm white	3000K	880lm	-	-	
591296	Energy-saving bulb	G5	13W	1,6	53,0	cold white	4300K	880lm	-	-	
548014	Energy-saving bulb	G5	14W	1,6	54,9	warm white	3000K	1230lm	Ra85	24000 h	
548114	Energy-saving bulb	G5	14W	1,6	54,9	cold white	4000K	1230lm	Ra85	24000 h	
Packaging unit: 25 pieces - 3pce. packaging with surcharge is possible, see info box below.											
548021	Energy-saving bulb	G5	21W	1,6	85,0	warm white	3000K	1910lm	Ra85	24000 h	
548121	Energy-saving bulb	G5	21W	1,6	85,0	cold white	4000K	1910lm	Ra85	24000 h	
548024	Energy-saving bulb	G5	24W	1,6	55,0	warm white	3000K	1700lm	Ra85	24000 h	
548124	Energy-saving bulb	G5	24W	1,6	55,0	cold white	4000K	1700lm	Ra85	24000 h	
548028	Energy-saving bulb	G5	28W	1,6	115,0	warm white	3000K	2640lm	Ra85	24000 h	
548128	Energy-saving bulb	G5	28W	1,6	115,0	cold white	4000K	2640lm	Ra85	24000 h	
548035	Energy-saving bulb	G5	35W	1,6	145,0	warm white	3000K	3320lm	Ra85	24000 h	
548135	Energy-saving bulb	G5	35W	1,6	145,0	cold white	4000K	3320lm	Ra85	24000 h	
548039	Energy-saving bulb	G5	39W	1,6	85,0	warm white	3000K	3220lm	Ra85	24000 h	
548139	Energy-saving bulb	G5	39W	1,6	85,0	cold white	4000K	3220lm	Ra85	24000 h	
548054	Energy-saving bulb	G5	54W	1,6	115,0	warm white	3000K	4450lm	Ra85	24000 h	
548154	Energy-saving bulb	G5	54W	1,6	115,0	cold white	4000K	4450lm	Ra85	24000 h	
Packaging unit: 25 pieces - 3pce. packaging with surcharge is possible, see info box below.											
548167	Energy-saving bulb	G5	21W	1,6	85,0	blue	-	-	-	-	
Packaging unit: 25 pieces - 3pce. packaging with surcharge is possible, see info box below.											
548201	Energy-saving bulb	G13	18W	2,6	59,0	cold white	4000K	1350lm	Ra85	20000 h	
548202	Energy-saving bulb	G13	18W	2,6	59,0	warm white	3000K	1350lm	Ra85	20000 h	
548195	Energy-saving bulb	G13	36W	2,6	120,0	green	-	3040lm	-	-	
548196	Energy-saving bulb	G13	36W	2,6	120,0	red	-	1250lm	-	-	
548197	Energy-saving bulb	G13	36W	2,6	120,0	blue	-	700lm	-	-	
Packaging unit: 25 pieces - 3pce. packaging with surcharge is possible, see info box below.											

SURCHARGE FOR 3pce PACKAGING for T5 and T8 bulbs (except ring tubes):

Type	Versions				Article No.	Price
T5	8W	13W	14W	24W	980010	
T5	21W	28W	39W	54W	980011	
T5	35W	-	-	-	980012	
T8	18W	-	-	-	980013	
T8	36W	-	-	-	980014	

BRICK LED 16 STAINLESS577
 BRICK LED 24 STAINLESS577
 BRICK LED DOWNUNDER577
 BRICK LED DOWNUNDER, vertical577
 BRICK MESH LED577
 BRICK MESH STAINLESS574
 BULAN, ceiling lamp531
 BULAN GRID, wall lamp531
 BULBS646-661

C
 C-POL479
 C-POL WALL479
 C-TRACK® basic components297

CALMA, wall lamp130
 CALU Downlight570
 CELLINERO, table lamp029
 CHROM DOWNLIGHT, round385
 CHROMBO TC-S, wall lamp196
 CHROMBO, wall lamp196
 CHROME DOWNLIGHT, square390
 CL 101 GX53, ceiling lamp121
 CL 135 T5-R, ceiling lamp122
 COMET lamp, for rope system306
 COMMO CL-1, ceiling lamp115
 COMMO PD-1, pendant luminaire095
 COMMO PD-1, pendant luminaire, for 1Phase267
 CONE OUTDOOR lamp447
 CONE SHADE Satin041
 CONE SHADE Tinto041
 CORDA, pendant luminaire008
 CORONA CL-1, ceiling lamp116
 COSMIC lamp holder slewable, for rope system308
 COUPA FLEXLED, wall lamp033
 CREST 1, wall lamp137
 CREST 2, wall lamp137
 CREST PD-1, pendant luminaire096
 CREST WL-1, wall lamp213
 CRYSTAL 1 Downlight397
 CRYSTAL 2 Downlight397
 CRYSTAL 4 Downlight397
 CRYSTAL 6 Downlight396
 CRYSTAL 8 Downlight396
 CUBIC PATH LIGHT L-Type494
 CUBIC PATH LIGHT T-Type494
 CUBIX 1 Lamp554
 CUBIX 2 Lamp554
 CYGNIS PD-1, pendant luminaire082
 CYGNIS, table lamp049
 CYLOVA, wall lamp139

D
 D-RECTION 35W GU6,5 Spot, for 1Phase262
 D-RECTION 35W GU6,5 Spot, for 3Phase242
 D-RECTION 70W G12 Spot, for 3Phase242
 D-RECTION ELITE 50, G12 Spot, for 3Phase242
 DABO Minispot for C-Track®296
 DACU G9181
 DACU G9521
 DACU LED181
 DACU LED521
 DACU SPACE, wall lamp176
 DACU UP-DOWN520
 DACU UP-DOWN180
 DACU UP-DOWN LED520
 DACU UP-DOWN LED180
 DACU UP-DOWN LED BEAM180
 DACU UP-DOWN LED BEAM520
 DARIUS, wall and ceiling lamp136
 DASAR® 115 GU10597
 DASAR® 115 MR16, rigid594
 DASAR® 115 MR16, slewable594
 DASAR® 260, HIT-T, 150W, round602
 DASAR® 260, HIT-T, 150W, square602
 DASAR® EXACT GU10, square597
 DASAR® EXACT MR16594
 DASAR® HQI SQUARE 70, asymmetrical603
 DASAR® T5-14, ground profile601
 DASAR® T5-21, ground profile601
 DASAR® HIT-DE 150W, asymmetrical603
 DASAR® 115 LED586
 DASAR® 215 UNI600
 DASAR® 260 UNI600
 DASAR® 9x1W LED586
 DASAR® ES111598
 DASAR® FLAT LED586
 DASAR® GX10602
 DASAR® GX53586
 DASAR® MODULE LED587
 DASAR® SQUARE GU10596
 DECREDO, table lamp029
 DEKLED364
 DELF C PRO611
 DELF C PRO RGB611
 DELSIN LED, wall and ceiling lamp518
 DELWA522
 DELWA BLUE522
 DELWA BLUE LED, wall lamp182
 DELWA CURVE, wall lamp525
 DELWA PATHLIGHT453
 DELWA wall lamp182
 DELWA WIDE523
 DELWA WIDE, wall lamp182
 DENA 1, wall lamp132
 DENA 2, wall lamp132
 DETT, outdoor lamp445
 DEVIN DOUBLE, wall lamp130
 DEWI Desk050
 DEWI Floor050
 DEWI pendant luminaire, for Linux Light® chrome289
 DICHRO CUBE Downlight409

DIO FLEX PLATE GU10314
 DIO FLEX PLATE LED314
 DIO FLEX PLUG LED315
 DIO, wall lamp162
 DISC DOWNLIGHT398
 DISPLAY ADL 50/GU10323
 DISPLAY ADL 50/MR16323
 DISPLAY GX53319
 DIVIS G12 Downlight429
 DIVIS GU6,5 Downlight429
 DL 123 LED FURNITURE326
 DL 124 LED FURNITURE326
 DL 125 LED FURNITURE326
 DomeLED CEILING lamp164
 DomeLED DISPLAY319
 DomeLED DOWNLIGHT374
 DOMELED Spot230
 DORU571
 DORU Downlight384
 DOWNUNDER 05356
 DOWNUNDER 1356
 DOWNUNDER 2356
 DOWNUNDER 3356
 DOWNUNDER LED 14578
 DOWNUNDER LED 15578
 DOWNUNDER LED 15355
 DOWNUNDER LED 27578
 DOWNUNDER LED 27355
 DOWNUNDER OUT TC-D575
 DOWNUNDER RCL 101355
 DP 118 R7s, mirror lamp317
 DP 119 LED surface mounted cupboard luminaire317
 DRAGAN GRID, wall lamp531
 DRAGAN SQUARE532
 DRAGAN, wall and ceiling lamp531
 DROP 50499
 DROP 100499
 DURANZ, pendant luminaire070

E
 E27 surface mounted, downlight163
 EASYLITE® DISPLAY G12539
 EASYLITE® DISPLAY GU10539
 EASYLITE® SPIKE GU10555
 EASYLITE® SPOT E27553
 EASYLITE® SPOT ES111550
 EASYLITE® SPOT G12551
 EASYLITE® SPOT GU10555
 EASYLITE® SPOT MR16559
 EASYLITE® SPOT QRB111551
 EASYTEC® II, chrome/black, basic components281
 EASYTEC® II, silver grey, basic components287
 EASYTEC® II track, chrome/black, 2 m281
 ELSU, pendant luminaire099
 ELT DOWNLIGHT415
 ENNA, wall lamp162
 ENOLA, pendant luminaire095
 ENOLA_B CL-1175
 ENOLA_B SPOT 1175
 ENOLA_B SPOT 2175
 ENOLA_B UP-DOWN175
 ESSENS 18W Downlight417
 ESSENS 26W Downlight417
 ESSENS HQI 70W, Downlight430
 ESSENS HQI 150W, Downlight430
 EURO SPOT E27 ELT, for 3Phase239

EURO SPOT ES11, for 1Phase264
 EURO SPOT ES11, for 3Phase236
 EURO SPOT EVG, for 3Phase235
 EURO SPOT G12, for 3Phase235
 EURO SPOT GU10, for 1Phase269
 EURO SPOT GU10, for 3Phase239
 EURO SPOT INTEGRATED LED, for 1Phase261
 EURO SPOT INTEGRATED LED, for 3Phase233
 EURO SPOT LED DISK 800, for 1Phase261
 EURO SPOT LED DISK 800, for 3Phase233
 EURO SPOT MR16, for 3Phase239
 EURO SPOT QRB111, for 3Phase236
 EYEDOWN LED 3x1W372
 EYEDOWN LED 3x1W572
 EYEDOWN LED 6x 1W372
 EYEDOWN LED 6x1W572

F
 FGL OUT GU10 ROUND572
 FGL OUT GU10 SQUARE409
 FGL OUT GU10 SQUARE572
 FGL OUT GU10 ROUND405
 FGL OUT MR16 ROUND571
 FGL OUT MR16 SQUARE571
 FGL OUT MR16 ROUND385
 FGL OUT MR16 SQUARE390
 FILI DISPLAY lamp GU10321
 FILI DISPLAY with canopy321
 FLAC BEAM® HQI 70W550
 FLAT 121, wall lamp206
 FLAT FRAME Basic382
 FLAT FRAME Curve382
 FLAT FRAME Slat382
 FLEXLED ROLL 12V AC616
 FLEXLED ROLL 12V DC616
 FLEXLED ROLL 24V DC617
 FLEXLED ROLL PRO 12V DC619
 FLEXLED ROLL PRO 24V DC619
 FLEXLED ROLL RGB 12V DC622
 FLEXLED ROLL RGB 24V DC622
 FOK LED358
 FORCHINI PD-1, pendant luminaire038
 FORCHINI PD-2, pendant luminaire038
 FORTY-TWO LED Downlight380
 FRAME383
 FRAME BASIC GU10409
 FRAME BASIC JC383
 FRAME BASIC LED360
 FRAME BASIC MR16392
 FRAME CURVE383
 FRAME CURVE LED360
 FRAME DISTA GU10409
 FRAME DISTA MR16392
 FURNITURE 513325
 FURNITURE LED 121324
 FURNITURE LED 65324
 FURNITURE LED ROUND, Downlight326

- wall and ceiling lamp 165
 LIGHT EYE X3,
 pendant luminaire 086
 LIGHT PIPE 446
 LIGHTPOINT 396
 LIGHTTUBE Lamp,
 for Wave track system 305
 LIKA Lamp head,
 for Linux Light®, chrome 290
 LIKA Lamp head,
 for Linux Light®, silver grey 294
 LIM® RGB MASTER LIGHT
 MODULE 3x36W 605
 LIMA Spot,
 for Easytec® II, silver grey 282
 LIMA UP-DOWN,
 wall lamp 161
 LINE armature 129
 LINUX LIGHT®,
 chrome, basic components 291
 LINUX LIGHT®,
 silver grey, basic components 295
 LIPSY®,
 ceiling lamp 125
 LIPSY® DOUBLE,
 pendant luminaire 100
 LIPSY® OUT CEILING 125
 LIPSY® OUT FLOOR 444
 LIPSY®,
 pendant luminaire 100
 LOGS 40 449
 LOGS 70 449
 LOGS WALL 449
 LONG GRILL,
 ceiling lamp 222
 LONG GRILL,
 pendant luminaire 063
 LOUISSE 1,
 ceiling lamp 124
 LOUISSE 2,
 ceiling lamp 124
 LOW-VOLTAGE ROPE SYSTEM,
 basic components 309
 LUNA 1 Spot,
 for 1Phase 264
 LUNA 1 Spot,
 for 3Phase 252
 LUZO 2 Downlight 385
 LUZO INTEGRATED LED 376
 LUZO LED DISK 376
- M**
 MALANG CL-1 037
 MALANG LED,
 pendant luminaire 104
 MALANG PD-1,
 pendant luminaire 037
 MEDO,
 ceiling lamp 121
 MEDO,
 pendant luminaire 102
 MEDO PRO 60,
 ceiling lamp 123
 MEDO PRO 60,
 pendant luminaire 103
 MELAN,
 ceiling lamp 116
 MERIDIAN 2,
 wall lamp 528
 MERIDIAN 3,
 wall lamp 528
 MERIDIAN BOX,
 wall lamp 528
 MIBO CURVE,
 mirror lamp 316
 MIBO STRAIGHT,
 mirror lamp 316
 MIBO WALL,
 up-down 133
 MICRO FLAT 500
 MINI ALU TRACK,
 basic components 300
 MINI BEAM,
 wall lamp 194
 MINI EYE LED 518
- MINI FRAME LED 362
 MINI LED MODULE CHAIN 607
 MINIPOL LED 564
 MR11 SP Downlight 387
 MR16 SP Downlight 387
 MYRA 2 LAMP HEAD 496
 MYRA CURVED,
 Display lamp 538
 MYRA STRAIGHT,
 Display lamp 538
 MYRA UP-DOWN,
 wall lamp 498
 MYRA WALL 498
- N**
 N-TIC PRO GU10 597
 N-TIC PRO MR16 592
 N-TIC ROUND 593
 N-TIC SQUARE 593
 N-TIC SPOT 230V 159
 NAILS FLOOR LAMP 492
 NAILS SPIKE 492
 NAILS WALL LAMP 492
 NAUTILUS GX53 stainless 560
 NAUTILUS IP67 559
 NAUTILUS LED 304B 563
 NAUTILUS LED 304S 563
 NAUTILUS LED STAINLESS 563
 NAUTILUS MR16,
 stainless steel 559
 NAUTILUS PAR38,
 stainless steel 553
 NAUTILUS SPIKE 556
 NAUTILUS SPIKE LED 561
 NAUTILUS SPIKE LED,
 COMPACT 561
 NAUTILUS SPIKE XL 556
 NAVALIS,
 pendant luminaire 083
 NAVIGATOR® G8,5,
 for 3Phase 247
 NEAT,
 display lamp 322
 NEAT FLEX CLAMP 322
 NEAT FLEX PLATE,
 recessed lamp 322
 NEODISC,
 wall and ceiling lamp 217
 NEOPAN,
 wall lamp 217
 NEPRO 2 26W TC-D Spot,
 for 1Phase 265
 NEPRO 2 26W TC-D Spot,
 for 3Phase 256
 NEPRO 2 PL Spot,
 for 3Phase 256
 NEPRO 2 R7s Spot,
 for 3Phase 248
 NEPRO 2 T5 Spot,
 for 3Phase 256
 NEPRO,
 display lamp 318
 NEPRO LINE,
 wall lamp 199
 NEPRO WALL 192
 NEW ANDREAS,
 wall lamp 195
 NEW POL 477
 NEW SHELL WL-1 TC-DE,
 wall lamp 215
 NEW SHELL WL-2 Rx7s 215
 NEW TRIA ES111 413
 NEW TRIA ES111 331
 NEW TRIA G12 332
 NEW TRIA G12 428
 NEW TRIA GU10 331
 NEW TRIA GU10 406
 NEW TRIA GX10 332
 NEW TRIA GX10 428
 NEW TRIA LED DISK 332
 NEW TRIA LED DISK 377
 NEW TRIA MR16 330
 NEW TRIA MR16 394
 NEW TRIA QRB111 331
- NEW TRIA ROUND MR16 387
 NEW TRIA RUND GU10 405
 NEW TRIA RUND ES111 410
 NEW TRIA RUND QRB111 398
 NEW TRIA RUND QRB111 401
 NEW TURNO MR16,
 Downlight 388
 NICELIGHT 1 390
 NONDRI Lamp head,
 for Linux Light®, chrome 289
 NOVA WALL OUT 513
- O**
 ONIO HIT-TC TWIST,
 wall lamp 214
 ONIO R7s,
 wall lamp 211
 ONIO T5 TWIST,
 wall lamp 211
 ONIO T5,
 wall lamp 211
 OPEN GRILL,
 pendant luminaire 074
 OPEN GRILL SINGLE,
 pendant luminaire 069
 OPEN GRILL,
 wall and ceiling lamp 217
 ORION 40,
 pendant luminaire 089
 ORION pendant luminaire,
 for Linux Light®, silver grey 293
 ORION PENDENT,
 for Linux Light®, chrome 289
 ORION PLATE,
 ceiling lamp 115
 OSSA R7s,
 wall lamp 176
 OTOS GLASS 478
 OTOS PL 478
 OUT 65 Downlight 571
 OUT BEAM G8,5 535
 OUT-BEAM G9 535
 OUT-BEAM R7s 535
 OUT-BEAM ROUND G9 535
 OVA 75 489
 OVA 100 489
 OVA TORCH 488
 OVA WALL 488
 OVA Wall, 2xGU10 192
 OVO ES111,
 pendant luminaire 084
- P**
 PADI LED 600 610
 PAR 16 Mesh,
 for 1Phase 263
 PAR 16 Mesh,
 for 3Phase 249
 PAR 20 Mesh,
 for 1Phase 263
 PAR 20 Mesh,
 for 3Phase 249
 PAR 30 Mesh,
 for 1Phase 263
 PAR 30 Mesh,
 for 3Phase 249
 PARA 380,
 reflector lamp 108
 PARA DOME 2 E27,
 pendant luminaire 108
 PARA DOME 2 HQI,
 pendant luminaire 109
 PARA LED,
 pendant luminaire 108
 PARA MULTI 406,
 pendant luminaire 108
 PARA MULTI 406 VG,
 pendant luminaire 109
 PD 115 E27,
 pendant luminaire 041
- PEMA LED WALL LAMP 518
 PEMA® SQUARE,
 wall lamp 512
 PEMA®,
 wall lamp 512
 PERRI,
 pendant luminaire 091
 PICOSI DESK,
 table lamp 048
 PICTURE LIGHT 8W 311
 PICTURE LIGHT 13W 311
 PIKA Downlight 385
 PIKA Slewable 387
 PIRUS,
 pendant luminaire 093
 PIRUS pendant luminaire,
 for 1Phase 267
 PIRUS pendant luminaire,
 for 3Phase 253
 PIRUS pendant luminaire,
 for Easytec® II, chrome/black 280
 PIRUS pendant luminaire,
 for Easytec® II, silver grey 284
 PL Aufbaustrahler, 2x26W 121
 PL-DL IP65 573
 PL2/24 SHOP,
 for 3Phase 256
 PLADO 18W Downlight 419
 PLADO 26W Downlight 419
 POL IP 54 477
 POWER TRAIL-LITE 585
 POWER-LED Spot,
 for Glu-Trax® 298
 PURI Lamp head,
 for 1Phase 270
 PURI Lamp head,
 for 3Phase 254
- Q**
 Q-Line Double,
 pendant luminaire 066
 Q-Line Single,
 pendant luminaire 066
 Q-Line Wall 208
 Q-TECH® G12 HOR,
 for 3Phase 247
 Q-TECH® SPOT GU10,
 for 3Phase 254
 Q-TECH® SPOT GU10,
 for 1Phase 270
 Q-TECH® SPOT G12 HOR,
 for 1Phase 262
 QRB SPOT,
 for Linux Light®, silver grey 294
 QRB SPOT,
 for Linux Light®, chrome 291
 QRB SPOT,
 for Wave track system 305
 QUAD 1 522
 QUAD 1,
 wall lamp 191
 QUAD 2 522
 QUAD 2,
 wall lamp 191
 QUADRASYL 44 B 504
 QUADRASYL 44 D 504
 QUADRASYL 44 WALL 504
 QUADRASYL D 504
 QUADRASYL SL 75 503
 QUADRASYL WL 15 503
 QUOR 52 EVG Downlight 421
- R**
 R7s SHOP,
 for 3Phase 248
 RAKA SPOT,
 for Easytec® II, chrome/black 278
 RAPIDO 2x26W EVG 419
 RAPIDO Out/EVG 573

RCL 102 TC-DE FRAMELESS, SET.....	417	SAIL R7s lamp head, for Easytec® II, silver grey	284	SOPRANA PD-3, for 1Phase.....	265	T T5 DUO SPOT, wall lamp.....	201
RCL 103 TC-DE FRAMELESS, SET.....	417	SAIL Spot for rope system....	307	SOPRANA PD-3, pendant luminaire.....	019	T5 GRILL, pendant luminaire.....	074
REAL N-TIC LED SERIES, 108x46.....	367	SAINT 22, wall lamp.....	126	SOPRANA PD-4, pendant luminaire.....	019	T5 Grill QRB, pendant luminaire.....	074
REAL N-TIC LED SERIES, 152x46.....	367	SALUNA, for rope system.....	308	SOPRANA SL-1, floor lamp.....	016	T5 GRILL UNI.....	216
RED 4W LED, wall lamp.....	134	SATINA Downlight.....	398	SOPRANA SL-2, floor lamp.....	015	T5-BAR 24W.....	422
RETROSIX QRB 1/2, black wall and ceiling lamp.....	148	SDL 150, for 3Phase.....	244	SOPRANA SL-3, floor lamp.....	011	T5-BAR 54W.....	422
RETROSIX QRB 1/2, clear wall and ceiling lamp.....	148	SDL 70, for 3Phase.....	244	SOPRANA SOLID PD-1, pendant luminaire.....	013	TANI wall lamp.....	196
RGB FLOOD 30W.....	569	SDL DISPLAY.....	318	SOPRANA SOLID TL-1, table lamp.....	013	TC DL 2x13W EVG.....	420
RIFFA CL-1, ceiling lamp.....	221	SDL PRO 150, for 3Phase.....	244	SOPRANA TL-1, table lamp.....	016	TC DL 2x26W EVG.....	420
RIFFA CL-2, ceiling lamp.....	221	SDL PRO 70, for 3Phase.....	244	SOPRANA TL-2, table lamp.....	015	TC GRID 218, surface mounted lamp.....	225
RIFFA PD-101, pendant luminaire.....	065	SEDO 14/21, wall lamp.....	204	SOPRANA WL-1, wall lamp.....	009	TC GRID 336, surface mounted lamp.....	225
RIFFA PD-102, pendant luminaire.....	065	SFL® PAR 56 T 70 LONG HV, G12.....	227	SOPRANA WL-2, wall lamp.....	011	TC INDI 255, surface mounted lamp.....	225
RIOTTE SMALL, table lamp.....	034	SFL® PAR 56 T 150 LONG HV, G12.....	227	SPACE Lamp, for Wave track system.....	304	TEC 1 QRB Spot, for 1Phase.....	264
RIOTTE, table lamp.....	034	SFL® PAR 56 TS 70 LONG HV, Rx7s.....	227	SPACE Lamp head, for Linux Light®, silver grey....	294	TEC 1 QRB Spot, for 3Phase.....	250
ROBOT 2 slewable, for Glu-Trax track.....	298	SFL® PAR 56 TS 150 LONG HV, Rx7s.....	227	SPHERE WIRE Spot, for rope system.....	307	TEC 2 QRB Spot, for 1Phase.....	264
ROPE LAMP MR16, for rope system.....	309	SFL® PAR20 G.....	226	SPOT 79, 230V.....	159	TEC 2 QRB Spot, for 3Phase.....	250
ROPE LAMP QRB, for rope system.....	306	SFL® PAR36 ES111.....	226	SQUARE.....	390	TEC 4 QRB Spot, suspension set.....	149
ROTOBALL E27, pendant luminaire.....	107	SHELL HQI-TS, wall lamp.....	214	SQUARE C, wall and ceiling lamp.....	464	TEC KARDA 2 QRB, suspension set.....	149
ROTOBALL HIT, pendant luminaire.....	107	SHUTTERS, for SFL®.....	227	SQUARE DICE 1, wall and ceiling lamp.....	173	TEC KARDA 2 QRB, wall and ceiling lamp.....	149
ROVEN, pendant luminaire.....	036	SIENA Lamp head, for Easytec® II, black/chrome....	278	SQUARE DICE 2, wall and ceiling lamp.....	173	TEC KARDA 4 QRB, wall and ceiling lamp.....	149
ROW 1 GU10, Downlight.....	408	SIENA Lamp head, for Easytec® II, silver grey....	282	SQUARE DL 195 G12.....	430	TEC KARDA 6 QRB, suspension set.....	149
ROW MR16, Downlight.....	394	SIGHT 24, wall and ceiling lamp.....	207	SQUARE POLE 30.....	464	TEC KARDA 6 QRB, wall and ceiling lamp.....	149
ROX ACRYLIC C.....	458	SIGHT 54, wall and ceiling lamp.....	207	SQUARE POLE 60.....	464	TELESCOPE lamp, for rope system.....	309
ROX ACRYLIC POLE 30.....	458	SILKON LED FLEXSTRIP 12V DC.....	627	SQUARE POLE 90.....	464	TENDA LED, wall lamp.....	524
ROX ACRYLIC POLE 60.....	458	SIMIT 20° Downlight, slewable.....	364	SQUARE TURN Floor.....	447	THEO CEILING OUT, ceiling lamp.....	509
ROX ACRYLIC POLE 90.....	458	SITRA 360 SL.....	495	SQUARE TURN G9, wall lamp.....	527	THEO UP-DOWN GU10, wall lamp.....	169
ROX ACRYLIC SINGLE, wall lamp.....	458	SITRA 360 WL.....	495	SQUARE TURN HIT-TC, wall lamp.....	527	THEO UP-DOWN OUT, wall lamp.....	509
ROX ACRYLIC UP-DOWN, wall lamp.....	458	SITRA 6x1W LED.....	501	SQUARE WALL.....	172	THEOS 101 E27, wall lamp.....	514
ROX CEILING, ceiling lamp.....	166	SITRA CUBE.....	505	SQUARE WL.....	464	THEOS 102 E27, wall lamp.....	514
ROX CEILING GX53 OUT.....	457	SITRA DISPLAY.....	538	STAR Lamp, for Wave track system.....	304	THEOS 103 TC-DE.....	517
ROX CEILING OUT.....	456	SITRA EARTH SPIKE.....	560	STIX wall lamp.....	312	THEOS CL 104 PL.....	533
ROX OUT LED up-down.....	498	SITRA SL.....	502	STRATOS, Lamp head, for Linux Light®, silver grey....	293	THEOS CL 104 PL.....	517
ROX PATHLIGHT.....	454	SITRA WALL.....	500	SUN CEILING, lamp.....	114	THEOS FLOOD RX7s.....	537
ROX PATHLIGHT GX53.....	454	SITRA WALL UP-DOWN.....	501	SUN, pendant luminaire.....	089	THEOS FLOOD TC-D.....	537
ROX PRO G8,5.....	536	SKELETTO, display lamp.....	318	SURA lamp, for rope system.....	308	TIDUR WALL, profile lamp.....	210
ROX UP-DOWN GX53 OUT.....	457	SKELETTO Lamp head, for 1Phase.....	262	SWIFTEC Lamp head, for Easytec® II, silver grey....	284	TIGLA ROUND, Downlight.....	161
ROX UP-DOWN OUT.....	456	SKELETTO Lamp head, for 3Phase.....	248	SWIFTEC pendant luminaire, for Easytec® II, silver grey....	284	TIGLA SQUARE, Downlight.....	161
ROX UP-DOWN, wall lamp.....	166	SKY PLOT LED.....	582	SWORD WL 160, wall lamp.....	212	TOBU lamp head, for 1Phase.....	269
ROX WALL.....	166	SLEEK LED UP-DOWN, wall lamp.....	191	SXL 2 2x26W.....	547	TONGA 1, pendant luminaire.....	092
ROX WALL GX53 OUT.....	457	SLEEK SPOT G12 deco ring.....	241	SXL 2 E27.....	547	TONGA 1 pendant luminaire, for Easytec® II, silver grey....	286
ROX WALL OUT.....	456	SLLM ES111 Downlight.....	410	SXL COMPACT G9.....	544	TONGA 4, pendant luminaire.....	092
RUSTY 40.....	467	SLLM GU10 Downlight.....	404	SXL COMPACT GU6.5.....	544	TONGA 4 pendant luminaire, for 1Phase.....	267
RUSTY 70.....	467	SLLM MR16 Downlight.....	384	SXL COMPACT R7s.....	545	TONGA 4 pendant luminaire, for Linux Light®, silver grey....	293
RUSTY CONE 40.....	471	SLOTS 300.....	461	SXL ECO.....	547	TRAIL-LITE.....	585
RUSTY CONE 70.....	471	SO-TOO, pendant luminaire.....	093	SXL HIT FLOODLIGHT 400W...	548	TRIA 2 DOWNLIGHT.....	389
RUSTY CONE, floor lamp.....	471	SO-TOO pendant luminaire, for 1Phase.....	267	SXL HIT-DE 70W.....	548	TRISTAN T8 36W, ceiling lamp.....	224
RUSTY PATHLIGHT.....	472	SO-TOO pendant luminaire, for 3Phase.....	248	SXL HIT-DE 150W.....	548	TRISTAN T8 58W, ceiling lamp.....	224
RUSTY SLOT 50.....	468	SKY PLOT LED.....	582	SYROS lamp, for rope system.....	308	TRISTAN T8 18W, ceiling lamp.....	224
RUSTY SLOT 80.....	468	SLEEK LED UP-DOWN, wall lamp.....	185	SYROS lamp, for Wave track system.....	304	TRITON 3 GIMBLE.....	372
RUSTY SQUARE 40.....	467	SOLO 90° Spot slewable, for Glu-Trax®.....	298	SYROS lamp head, for Linux Light®, silver grey....	294		
RUSTY SQUARE 70.....	467	SOPRANA PD-1, pendant luminaire.....	019	SYROS lamp head, for Linux Light®, chrome.....	290		
		SOPRANA CL-1, ceiling lamp.....	015				
		SOPRANA PD-2, pendant luminaire.....	016				

S

SAIL Lamp head,
for Linux Light®, silver grey....293

TRITON 3 LED	372	X	
TRITON 6	373	XERXES CHROME,	
TRITON 6 GIMBLE	373	ceiling lamp	217
TRITON MINI LED HORN	364	Y	
TROMP CL-1,		YANTI,	
ceiling lamp	122	for Linux Light®, silver grey	293
TROMP Downlight	410	YANTI,	
TROMP PD-1,		for Easytec® II, silver grey	284
pendant luminaire	102	YOKI ES111,	
TRUST 30	490	for Easytec® II, chrome/black	279
TRUST 60	490	YOKI ES111,	
TRUST WALL	490	for Easytec® II, silver grey	283
TUBE,		YOKI SPOT ES111,	
ceiling lamp	121	for 3Phase	252
TUBE kit for NEPRO Display	318	YUDI Downlight	396
TURNO GU10,			
Downlight	405	Z	
TWINTUBE,		Z 211,	
for 1Phase	265	wall lamp	129
TWINTUBE,		ZEBLED ROUND 3,	
for 3Phase	256	Downlight	366
TWINTUBE,		ZENIT,	
pendant luminaire	072	wall lamp	139
TWISTER Downlight	393		
TWISTER DOWNLIGHT,			
Sets	436		
TWISTER ES111 Downlight	434		
.....	434		
TWISTER FRAMES	435		
TWISTER GU6,5 Downlight	434		
.....	434		
TWISTER QRB Downlight	434		
U			
UFO BEAM	524		
V			
VANO DISPLAY	540		
VANO TC,			
outdoor lamp	540		
VANO WING PL,			
wall lamp	540		
VANO WING,			
wall lamp	540		
VAP SLIM	460		
W			
WALLYX GU10,			
wall lamp	511		
WETSY	588		
WETSY LED 230V	588		
WETSY LED DISK 300	588		
WETSY POWER LED	588		
WHEEL PC,			
pendant luminaire	100		
WL 103 E14,			
wall lamp	116		
WL 104 E27,			
wall lamp	116		
WL 105,			
wall lamp	131		
WL 106,			
wall lamp	131		
WL 149 G9,			
wall lamp	197		
WL 149 R7s,			
wall lamp	197		
WL 172 GX53,			
wall lamp	518		
WORK LIGHT,			
floor lamp	051		
WORK LIGHT,			
pendant luminaire	063		
WORKLIGHT WAVE PD-1,			
pendant luminaire	070		
WORKLIGHT WAVE WL-1,			
wall lamp	199		

150471	215	151811	175	153301	254	153901	233	155000	
150474	215	151814	175	153304	254	153904	233	155001	208
150481	215	151821	175	153400	235	153910	233	155002	208
150484	215	151824	175	153401	235	153911	233	155011	066
150491	215	151831	175	153404	235	153914	233	155012	066
150494	215	151834	175	153410	235	153920	233	155021	066
150551	244	151840	175	153411	235	153921	233	155022	066
150552	244	151862	383	153414	235	153924	233	155051	066, 208
150561	244	151871	383	153421	236	153930	233	155052	066, 208
150562	244	151878	383	153424	236	153931	233	155162	201
150571	244	151901	161	153430	236	153934	233	155172	217
150572	244	151910	163	153431	236	153940	233	155180	118
150601	247	151912	162	153434	236	153941	233	155185	118
150602	247	151914	163	153461	239	153944	233	155190	118
150611	247	151922	162	153464	239	153950	233	155195	118
150612	247	151932	139	153480	239	153951	233	155206	204
150621	247	151970	356	153481	239	153954	233	155216	204
150622	247	151971	356	153484	239	153960	233	155236	116
150631	214	151972	356	153490	233	153961	233	155240	116
150632	214	151973	356	153491	233	153964	233	155250	116
150921	431	151982	192	153494	233	153970	233	155260	196
150929	431			153501	230	153971	233	155261	196
150931	431			153502	230	153974	233	155272	116
150939	431			153524	256	153980	233	155280	019
150971	437			153534	248	153981	233	155283	019
150979	437	152000		153544	256	153984	233	155290	024
150981	437	152041	181	153551	256	153990	233	155291	024
150989	437	152042	181	153554	256	153991	233	155292	019
		152061	355	153561	254	153994	233	155293	019
		152062	355	153564	254			155300	025
		152070	355	153601	230			155301	025
		152071	355	153602	230			155310	022
		152072	355	153621	244			155311	022
		152079	355	153624	244	154000		155320	021
151000		152081	169	153631	244	154012	334, 400	155321	021
151011	255	152082	169	153634	244	154022	334, 400	155330	021
151017	255	152089	169	153640	241	154032	334, 400	155340	022
151049	323	152154	249	153641	241	154042	334, 400	155341	022
151050	321	152164	249	153644	241	154052	335, 413	155352	015
151051	252, 264	152174	249	153650	241	154062	335, 413	155353	015
151132	173	152182	256	153651	241	154072	335, 413	155362	015
151142	173	152231	254	153654	241	154082	335, 413	155363	015
151200	134	152232	254	153660	241	154112	334, 394	155372	015
151211	134	152241	254	153661	241	154122	334, 394	155373	015
151240	115	152242	254	153664	241	154132	334, 394	155380	026
151282	133	152272	256	153670	241	154142	334, 394	155382	019
151301	191	152282	252	153671	241	154202	078	155383	019
151304	191	152301	248	153672	241	154212	078	155392	030
151361	187	152304	248	153674	241	154222	076	155394	030
151362	187	152311	248	153681	241	154232	076	155400	008
151370	178	152314	248	153682	241	154242	076	155402	008
151371	178	152404	248	153684	241	154252	076	155412	016
151390	172	152417	252	153710	242	154262	151	155422	016
151400	193	152500	229	153711	242	154292	151	155432	016
151404	193	152501	229	153712	242	154212	078	155440	029
151422	195	152504	229	153714	242	154222	076	155452	030
151424	195	152510	229	153721	242	154232	076	155470	041
151442	130	152511	229	153722	242	154242	076	155471	041
151451	176	152514	229	153723	242	154252	076	155500	038
151456	176	152520	229	153726	242	154262	151	155501	038
151462	196	152521	229	153730	242	154292	151	155510	038
151471	176	152524	229	153731	242	154302	076, 078	155511	038
151476	176	152530	229	153734	242	154312	076, 078	155520	038
151490	194	152531	229	153741	242	154332	058	155521	038
151501	170	152534	229	153742	242	154352	079	155530	038
151504	170	152561	415	153743	242	154362	079	155531	038
151511	170	152564	415	153746	242	154372	079	155560	026
151514	170			153761	242	154382	058	155610	026
151521	170			153762	242	154392	058	155620	009
151524	170			153764	242	154502	250	155621	009
151531	170			153840	235	154512	250	155633	011
151534	170			153841	235	154532	250	155643	011
151552	130			153844	235	154552	335, 406	155650	006
151561	170	153000		153844	235	154562	335, 406	155651	006
151564	170	153002	250	153850	239	154572	335, 406	155652	006
151600	178	153102	252	153851	239	154582	335, 406	155670	033
151601	178	153112	253	153854	239	154602	336	155673	033
151610	178	153121	253	153860	235	154612	336	155700	013
151611	178	153154	252	153861	235	154622	336	155710	013
151624	139	153164	247	153864	235	154632	336		
151635	136	153171	247	153870	235	154704	055		
151656	217	153172	247	153871	235	154714	055		
151674	194	153174	247	153874	235	154724	056		
151691	137	153176	247	153880	235	154734	056		
151695	137	153201	247	153884	235	154744	056		
151751	524	153204	247	153884	235	154754	056		
151757	524	153241	247, 262	153888	235	154764	056		
151762	204	153244	247, 262	153890	235	154774	056		
151772	204	153246	247, 262	153891	235	154784	056		
151801	175			153894	235	154794	056		
151804	175			153900	233	154804	056		
						154814	055	156000	
						154824	056	156632	226
								156662	227
								156672	227
								156682	227

156692.....227
156722.....226
156812.....227
156822.....227
156832.....227
156902.....227
156912.....227
156914.....227
156915.....227
156916.....227
156917.....227
156919.....227

157000

157012.....072
157031.....072
157052.....199
157092.....216
157102.....074
157112.....074
157152.....051
157154.....051
157192.....206
157202.....206
157222.....161
157224.....161
157232.....115
157242.....135
157252.....091
157284.....063
157304.....159
157314.....159
157322.....202
157334.....074
157371.....217
157384.....217
157394.....211
157404.....211
157414.....200
157424.....200
157472.....202
157494.....069
157514.....063
157524.....063
157534.....222
157544.....211
157551.....214
157554.....214
157561.....082
157564.....082
157574.....070
157584.....199
157604.....185
157611.....185
157801.....083
157804.....083

158000

158020.....605
158021.....605
158110.....
.....218, 424, 425
158202.....424
158221.....424
158304.....065
158314.....065
158320.....065
158334.....221
158344.....221
158501.....218, 425
158502.....218, 425
158511.....073
158512.....073
158521.....218
158522.....218
158531.....073
158532.....073
159000.....
159000.....150
159001.....150
159004.....150
159010.....150
159011.....150

159014.....150
159020.....080
159021.....080
159024.....080
159030.....081
159031.....081
159034.....081
159040.....080
159041.....080
159044.....080
159050.....081
159051.....081
159054.....081
159060.....081
159061.....081
159064.....081
159070.....080
159071.....080
159074.....080
159080.....081
159081.....081
159084.....081
159090.....060
159091.....060
159094.....060
159100.....060
159101.....060
159104.....060
159110.....061
159111.....061
159114.....061
159120.....061
159121.....061
159124.....061
159200.....080, 081
159201.....080, 081
159202.....080, 081

160000

160011.....420
160019.....420
160020.....421
160021.....421
160022.....421
160029.....421
160031.....420
160039.....420
160041.....416
160049.....416
160059.....416
160124.....422
160134.....422
160202.....207
160206.....207
160212.....207
160216.....207
160301.....324
160302.....324
160311.....324
160312.....324
160321.....324
160352.....368
160354.....368
160371.....368
160372.....368
160381.....368
160382.....368
160401.....378
160402.....378
160411.....378
160412.....378
160421.....378
160441.....378
160461.....379
160501.....348, 370
160502.....348, 370
160511.....348, 370
160512.....348, 370
160541.....377
160544.....377
160551.....377
160554.....377
160601.....368
160604.....368
160611.....370
160614.....370

160621.....368
160624.....368
160631.....370
160634.....370
160641.....374
160644.....374
160651.....374
160654.....374
160701.....325
160702.....129
160721.....325
160731.....325
160761.....224
160764.....224
160771.....225
160774.....221
160781.....225
160791.....225
160802.....064
160812.....064
160822.....064
160832.....069
160841.....224
160861.....224
160864.....224
160874.....070

161000

161326.....419
161431.....121
161434.....121
161441.....121
161501.....419
161511.....419
161521.....419
161531.....419
161641.....419
161651.....419
161741.....419
161751.....419

162000

162021.....426
162024.....426
162031.....426
162034.....426
162036.....426
162044.....430
162054.....437
162101.....429
162104.....429
162111.....429
162114.....429
162121.....429
162124.....429
162131.....429
162134.....429
162151.....426
162154.....426
162161.....429
162166.....429
162171.....429
162173.....429
162176.....429
162301.....430
162304.....430
162311.....430
162314.....430
162401.....377
162404.....377
162411.....377
162414.....377
162421.....380
162424.....380
162431.....380
162434.....380
162441.....378
162444.....378
162451.....380
162454.....380
162460.....379
162464.....379

162470.....379
162474.....379

165000

165100.....108
165110.....109
165140.....109
165160.....108, 109
165161.....109
165204.....108
165320.....109
165330.....109
165340.....108
165350.....108
165358.....108
165400.....107
165420.....107
165500.....041
165501.....041

167000

167032.....640
167039.....640

170000

170401.....319
170402.....319
170414.....318
170422.....322
170424.....322

180000

180000.....302
180001.....302
180002.....302
180012.....302
180030.....302
180031.....302
180040.....302
180041.....302
180042.....302
180050.....302
180051.....302
180052.....302
180060.....302
180061.....302
180062.....302
180080.....302
180081.....302
180082.....302
180160.....302
180161.....302

181000

181080.....308
181176.....307
181180.....308
181212.....308
181232.....308
181242.....308
181252.....307
181532.....309

182000

182150.....302
182151.....302
182152.....302

184000

184000.....281
184002.....287
184022.....287
184032.....287
184042.....287
184062.....287
184071.....283
184092.....282
184142.....287
184152.....284
184172.....287
184221.....284
184282.....284
184292.....287
184302.....287
184312.....287
184332.....287
184372.....284
184442.....283
184452.....282
184492.....282
184521.....286
184531.....286
184534.....286
184542.....283
184572.....284
184592.....285
184624.....283
184634.....283

185000

185002.....281
185020.....281
185032.....281
185042.....281
185062.....281
185092.....278
185142.....281
185172.....281
185221.....280
185232.....280
185294.....281
185302.....281
185450.....278
185521.....280
185580.....276
185582.....276
185590.....276
185592.....276
185622.....279
185692.....276
185712.....278
185742.....278

186000

186015.....298
186020.....298
186041.....298
186042.....298
186272.....298
186302.....309
186312.....309
186332.....309
186342.....309
186352.....309
186362.....309
186462.....306
186492.....309
186502.....300
186512.....300
186522.....300
186530.....300
186540.....300
186561.....300
186562.....300
186642.....309
186762.....298
186772.....298
186952.....298

188000	227392	582	228692	486	229262	643	229890	512
188002	227397	582	228702	486	229270	602	229894	512
188022	227400	580	228712	486	229274	602	229904	518
188032	227410	556	228722	486	229280	602	229905	518
188042	227418	556	482, 484, 486, 489		229284	602	229912	500
188062	227421	588	228725	643	229294	603	229981	507
188112	227422	588	228730	643	229300	603	229984	507
188122	227427	588	228752	486	229304	603	229991	507
188142	227431	588	228753	477	229311	586	229994	507
188152	227432	588	228754	449	229317	586		
188162	227437	588	228762	488	229320	597		
188182	227450	593	228765	488	229324	597		
	227457	593	228771	498	229330	594		
	227461	585	228774	498	229334	594		
	227462	585	228775	498	229340	594	230000	
	227467	585	228776	498	229344	594	230030	512
	227471	585	228782	498	229360	586	230031	512
211000	227472	585	228785	498	229374	596	230034	512
211200	227480	588	228792	496	229392	540	230044	528
211201	227482	588	228802	498	229394	540	230045	528
	227485	588	228805	498	229395	541	230054	550
	227490	588	228812	538	229400	540	230060	460
	227495	588	228815	538	229402	541	230061	460
213000	227500	559	228842	538	229403	541	230063	460
213302	227520	593	228845	538	229405	540	230066	460
213312	227531	588	228862	484	229406	541	230069	460
213320	227532	588	228865	484	229410	468	230071	502
213321	227580	594	228872	484	229411	468	230090	472
213332	227582	594	228875	484	229420	467	230100	601
213342	227588	595	228882	485	229421	467	230110	601
213352	227690	547	228885	485	229422	467	230140	602
213361	227691	547	228892	486	229423	471	230144	602
	227698	547	228895	486	229430	471	230151	586
	227750	547	228902	486	229431	471	230152	586
	227754	547	228912	482	229432	471	230160	587
	227760	547	228915	482	229432	471	230164	587
220000	227764	547	228922	482	229453	569	230170	588
220000	227770	547	228925	482	229461	566	230174	588
220631	227774	547	228932	482	229462	566	230182	355
	227804	545	228935	482	229463	566	230192	355
	227814	545	228942	482	229481	566	230201	578
	227824	545	228945	482	229482	566	230202	578
	227845	477	228960	442	229493	569	230207	578
	227874	477	228965	442	229502	526	230207	578
	227881	536	228980	444	229512	136	230211	355
	227885	536			229531	509	230212	355
	227902	477			229532	509	230217	355
	227905	477			229536	509	230221	355
	227922	491			229541	507	230222	355
	227932	490	229000		229544	507	230231	577
	227942	490	229000	548	229551	506	230232	577
	227952	490	229001	548	229554	506	230237	577
	227962	490	229002	548	229561	506	230241	564
			229008	547	229564	506	230243	564
			229012	548	229571	506	230251	188
			229020	467	229574	506	230252	188
			229021	467	229581	509	230261	188
			229022	467	229584	509	230262	188
			229044	548	229601	507	230271	561
			229062	575	229604	507	230272	561
			229071	531	229611	514	230281	564
			229072	531	229616	514	230282	564
			229078	531	229618	514	230301	578
			229081	531	229621	514	230302	578
			229084	531	229626	514	230311	355
			229085	531	229628	514	230312	355
			229090	559	229641	524	230332	501
			229100	553	229642	524	230354	500
			229121	577	229647	524	230355	500
			229122	577	229701	577	230364	501
			229132	492	229702	577	230365	501
			229142	492	229712	575	230374	560
			229152	492	229722	577	230375	560
			229162	491	229730	560	230384	538
			229172	491	229731	563	230394	532
			229182	491	229732	563	230404	531
			229192	547	229746	457	230405	531
			229200	600	229746	457	230415	575
			229204	600	229756	456	230424	575
			229210	600	229766	456	230434	447
			229214	600	229776	456	230435	447
			229230	598	229786	457	230444	528
			229240	598	229820	628	230445	528
			229241	600	229821	628	230454	478
			229250	574	229836	454	230455	478
			229260	643	229840	454	230464	478
			229261	643	229841	454	230465	478
					229856	454	230481	577
					229860	463	230482	577
					229876	462	230494	517
					229886	462	230495	517

230505.....	559	231514.....	495	234002.....	606	470539.....	638	508441.....	661
230525.....	555	231515.....	495	234010.....	606	470540.....	638	508450.....	661
230535.....	539	231901.....	182, 522	234011.....	606	470541.....	637	508451.....	661
230545.....	555	231902.....	182, 522	234012.....	606	470542.....	637	508460.....	661
230555.....	552	231911.....	182, 522			470543.....	637	508461.....	661
230575.....	552	231912.....	182, 522			470544.....	637	508515.....	659
230595.....	551					470545.....	638	508560.....	658
230605.....	539					470546.....	638	508561.....	658
230615.....	553					470550.....	630	508600.....	659
230630.....	551					470560.....	630	508610.....	659
230641.....	528					470571.....	638	508630.....	659
230644.....	528	232000		410000		470581.....	634	508631.....	659
230645.....	528	232005.....	480	410120.....	644	470582.....	634	508730.....	659
230674.....	527	232015.....	480	410130.....	644	470583.....	634	508731.....	659
230684.....	527	232025.....	480	410140.....	645	470584.....	634	508740.....	659
230694.....	447	232035.....	480	410850.....	644	470588.....	632	508741.....	659
230706.....	464	232101.....	449	410851.....	644	470600.....	632	508760.....	659
230716.....	464	232104.....	449			470601.....	632	508761.....	659
230720.....	458	232105.....	449			470602.....	632	508770.....	659
230726.....	457	232114.....	449	450000		470610.....	632	508771.....	659
230736.....	458	232115.....	449	451010.....	640	470612.....	632	508800.....	659
230746.....	458	232124.....	449	451021.....	640	470620.....	632	508801.....	659
230767.....	182	232125.....	449	451022.....	641	470640.....	645	508810.....	659
230776.....	463	232201.....	453	451060.....	641	470700.....	633	508811.....	659
230786.....	463	232205.....	453	451105.....	641			508820.....	660
230791.....	182	232206.....	453	451150.....	641			508821.....	660
230794.....	182	232219.....	446	451250.....	641			508830.....	660
230801.....	563	232220.....	464	451300.....	641	500000		508831.....	660
230802.....	563	232236.....	464	451301.....	641	506160.....	652	508840.....	659
230811.....	563	232246.....	464	452021.....	641	506250.....	652	508841.....	659
230812.....	563	232249.....	464	455202.....	640	506982.....	651	508860.....	658
230822.....	518	232256.....	458	455209.....	640	506992.....	651	508861.....	658
230824.....	518	232266.....	458	455302.....	640	507020.....	651	508870.....	660
230852.....	518	232276.....	458	455309.....	640	507030.....	651	508910.....	658
230862.....	517	232284.....	503			507031.....	651	508911.....	658
230872.....	517	232285.....	503	460000		507035.....	651	508920.....	658
230900.....	593	232294.....	503	461050.....	643	507037.....	651	508921.....	658
230904.....	593	232295.....	503	461060.....	642	507045.....	651	508940.....	658
230910.....	597	232301.....	446	461062.....	642	507047.....	651	508941.....	658
230914.....	597	232302.....	446	461066.....	642	507070.....	652	508950.....	660
		232461.....	191, 522	461067.....	642	507071.....	652	508951.....	660
		232465.....	191, 522	461075.....	643	507120.....	651	508960.....	660
		232471.....	191, 522	461105.....	643	507121.....	651	508961.....	660
		232475.....	191, 522	461107.....	642	507130.....	651	508970.....	660
		232481.....	537	461155.....	643	507131.....	651	508971.....	660
231000		232485.....	537	461157.....	642	507140.....	651	508980.....	658
231011.....	518	232487.....	537	461217.....	642	507141.....	651	508981.....	658
231012.....	518	232491.....	514	461217.....	642	507150.....	652	509070.....	652
231021.....	561	232495.....	514	461310.....	642	507151.....	652	509071.....	652
231022.....	561	232497.....	514	464001.....	636	507210.....	651	509150.....	652
231101.....	542	232501.....	531	464002.....	636	507220.....	651	509151.....	652
231102.....	542	232504.....	531	464108.....	635	507240.....	651	509170.....	652
231111.....	542	232505.....	531	464109.....	635	507310.....	651	509171.....	652
231112.....	542	232531.....	505	464110.....	635	507311.....	651	509180.....	652
231113.....	569	232535.....	505	464111.....	635	507320.....	651	509191.....	652
231151.....	544	232537.....	505	464112.....	635	507321.....	651		
231152.....	544	232541.....	517, 533	464113.....	638	507340.....	651		
231161.....	544	232545.....	517, 533	464120.....	635	507341.....	651		
231162.....	544	232554.....	494	464200.....	636	507400.....	651		
231205.....	465	232564.....	494	464201.....	636	507410.....	651	510000	
231215.....	465	232600.....	608	464202.....	636	507420.....	651	510075.....	652
231225.....	465	232641.....	608	464203.....	638	507430.....	651	510077.....	652
231230.....	465	232651.....	608	464210.....	636	507440.....	651	510155.....	652
231231.....	453	232661.....	608	464301.....	635	507450.....	651	510157.....	652
231232.....	450	232681.....	608	464302.....	653	508170.....	652	510400.....	652
231233.....	473	232691.....	608			508171.....	652	512205.....	648
231234.....	458, 463	232700.....	608			508209.....	660	512210.....	648
231283.....	481	232711.....	608			508211.....	659	512220.....	648
231285.....	481	232712.....	608			508212.....	661	512235.....	648
231287.....	481	232717.....	608			508213.....	660	512250.....	648
231301.....	453	232741.....	608	470000		508218.....	660	519206.....	648
231305.....	453	232742.....	608	470070.....	639	508220.....	661	519215.....	648
231311.....	453	232747.....	608	470150.....	639	508222.....	661	519221.....	648
231315.....	453			470200.....	639	508226.....	660	519223.....	648
231325.....	450			470350.....	639	508309.....	660	519230.....	648
231335.....	450			470360.....	639	508310.....	660	519231.....	648
231345.....	451			470361.....	639	508311.....	660	519240.....	648
231400.....	474	233000		470370.....	639	508312.....	661	519241.....	648
231401.....	474	233001.....	626	470380.....	639	508313.....	660	519360.....	648
231410.....	474	233002.....	626	470500.....	637	508318.....	660	519450.....	648
231411.....	474	233007.....	626	470502.....	637	508320.....	661	519451.....	648
231420.....	473	233010.....	626	470503.....	632	508322.....	661	519452.....	648
231455.....	461	233011.....	626	470505.....	630	508326.....	660	519620.....	660
231465.....	479	233012.....	626	470506.....	637	508415.....	659	519725.....	652
231475.....	479			470507.....	637	508416.....	659	519727.....	652
231481.....	448			470508.....	637	508417.....	659	519737.....	652
231485.....	448			470509.....	630	508421.....	658	519739.....	652
231495.....	448			470520.....	634	508422.....	658	519760.....	652
231504.....	495	234000		470530.....	631	508440.....	661		
231505.....	495	234001.....	606	470531.....	631				

520000	550000	551382656	575510650	980014661
525212.....649	550091.....657	552001.....616	575511.....650	
525240.....649	550092.....657	552002.....616	575520.....649	
525312.....649	550097.....657	552003.....622	575530.....649	
525320.....649	550111.....656	552007.....616	575535.....649	
525340.....649	550112.....656	552011.....616	575540.....650	
525514.....649	550131.....656	552012.....616	575651.....650	
525525.....649	550132.....656	552013.....622	575652.....650	
525540.....649	550181.....614	552017.....616	575671.....650	
525555.....649	550182.....614	552021.....616	575672.....650	
	550187.....614	552022.....616	575682.....650	
	550190.....614	552023.....622		
	550191.....	552027.....616		
614, 615, 624	552031.....616		
530000	550192.....614	552032.....616	590000	
533228.....649	550193.....614	552041.....616	590144.....661	
533330.....649	550211.....580	552042.....616	590145.....661	
534240.....649	550212.....580	552051.....616	590150.....648	
534338.....649	550217.....580	552052.....616	590151.....648	
534540.....649	550251.....654	552061.....619	590152.....648	
535213.....649	550252.....654	552062.....619	590153.....661	
535240.....649	550260.....614	552071.....619	591293.....661	
535312.....649	550261.....614	552072.....619	591294.....661	
535338.....649	550262.....614	552101.....617	591295.....661	
535514.....649	550311.....654	552102.....617	591296.....661	
535527.....649	550312.....654	552103.....622		
535540.....649	550317.....654	552107.....617	630000	
535560.....649	550331.....580	552111.....617	631100.....607	
536138.....649	550332.....580	552112.....617	631451.....611	
536240.....649	550337.....580	552113.....622	631452.....611	
536338.....649	550341.....656	552117.....617	631453.....611	
536540.....649	550342.....656	552121.....617	631461.....611	
	550351.....656	552122.....617	631462.....611	
	550352.....656	552123.....622	631463.....611	
	550381.....656	552127.....617	631470.....611	
	550382.....656	552131.....619	631471.....611	
	550391.....656	552132.....619	631472.....611	
	550392.....656	552141.....619	631473.....611	
	550401.....607	552142.....619	631474.....611	
	550412.....616	552211.....621		
	550413.....617	552212.....621	900000	
	550414.....622	552213.....624	900011.....559	
	550415.....616	552221.....621		
	550416.....617, 619	552222.....621	920000	
	550417.....622	552223.....624	924036.....593	
	550418.....622	552241.....621	925100.....383	
	550419.....622	552242.....621	925190.....	
	550570.....	552243.....624	055, 064, 069, 070	
616, 617, 619	552251.....621	925195.....356	
	550621.....627	552252.....621	925200.....356	
	550622.....627	552253.....624	925201.....355	
	550627.....627	552300.....628	925250.....356	
	550630.....627	552301.....628	925251.....416	
	550641.....613	552302.....628	950000	
	550642.....613	552307.....628	955000.....645	
	550650.....613		955020.....645	
	550671.....363	560000	955030.....645	
	550672.....363	560011.....655	955135.....645	
	550721.....627	560012.....655	955137.....645	
	550722.....627	560013.....655	955138.....645	
	550790.....615	560014.....655		
	550791.....615	560041.....654	960000	
	550792.....615	560042.....654	961062.....639	
	550801.....654	560043.....654	961250.....644	
	550802.....654	560044.....654		
	550811.....655	560084.....655	980000	
	550812.....655	560091.....654	980010.....661	
	550911.....654	560092.....654	980011.....661	
	550912.....654	560093.....654	980012.....661	
	551121.....653	560101.....655	980013.....661	
	551122.....653	560102.....655		
	551131.....653	560103.....655		
	551132.....653	560104.....655		
	551221.....653	560201.....657		
	551222.....653	560202.....657		
	551231.....653			
	551232.....653	570000		
	551301.....655	570001.....656		
	551302.....655	570003.....656		
	551311.....655	575350.....650		
	551312.....655	575351.....650		
	551321.....655	575360.....649		
	551322.....655	575370.....649		
	551331.....655			
	551332.....655			
	551342.....657			
	551362.....654			
	551371.....657			
	551372.....657			

Specification of the max. current carrying capacity	16A max.
Protection class one-two-three	
Rotary range of the product with degree specification	 340°
Swivel range of the product with degree specification	 180°
Specification to the max. distance between ropes in cm	 20
Weight of the product in kg	 9,5
Max. conductor cross-section	max. 2,5 mm ²
Specification of cable diameter in mm	 7-12
Energy efficiency class ballast	
Protection in fault by indicated temperature in °C	
Emission angle symmetrical / focusable / asymmetrical	
Independant converter (electronic transformer can also be used externally).	
Installation depth in cm If a mounting pot is included in the delivery, the mounting dimensions refer to the size of the mounting pot.	 9,5
Height adjustability and pendant cable length in m Height adjustability for Jojo lamp. Pendant cable length for standard pendulum lamps.	 0 1,5 m
Indicates the average life span of bulbs in hours For GE bulbs: Indicates the average maximum life span of the bulb.	 2500
Specification of operating range Only suitable for indoor applications Not suitable for indoor applications Suitable for outdoor applications, IP classification	 IP44
Mounting on normal flammable surfaces Suitable for direct fixation (valid - unless otherwise specified - for all products illustrated in this catalogue) Not suitable for direct fixation Not suitable while using bulbs of >50W	
Dimmability Dimmable with trailing-edge phase dimmer. Dimmable with leading-edge phase dimmer. Dimmable with 1-10V. Dimmable with appropriate accessory (for bulbs e.g. dimmable electronic ballast).	

Impact strength of the product up to the specified value in joule	 20 J
Heat development on the surface of the ground recessed lamp.	90°C
Temperature protection with temperature specification in °C	 115°C
Specification of the incorporated number of single LEDs	 LED 35 Stk.
Form and size installation cut-out in cm	 12,5/12,5 7,2
Bulb is equipped with UV-protection	
Permissible ambient temperature or temperature range in C°	ta 40° ta -25° - +40°
LED can be replaced by a specialist.	
Short circuit proof protection transformer	
Light distribution curve A light distribution curve of the respective product can be sent to you on request.	
Weight capacity of product in tons Capacity up to indicated value. Measurements are based on fitting in concrete.	0,8 t
Through-wiring Through-wiring possible Through-wiring possible up to the specified number of lamps	 max. 10
Bulbs suitable for ...the application in lamps with protection glass. ...the application in lamps without protection glass.	
Bulb/lamp part cardanically slewable Cardanically slewable Cardanically slewable up to the indicated value in degree	 60°
Mounting on materials Allows the mounting of the lamp on materials (ex. wood) with unknown inflammation behaviour.	
Specification of operating range Ceiling - wall - ground Recessed Additional accessory is needed to mount the lamp	 ↑ ← ↓ ↑- ←+A
Operating voltage High-voltage 230- Integrated converter for 230V alternating voltage to 350mA direct current. Low-voltage with voltage converter for high-voltage systems 230~/12- Low-voltage 12-	230~ 230~/ MA 350 230~/ 12- 12~
Attributes of reflector lamps Multi mirror bulbs (cool beam): The major part of the heat is emitted to the rear side of the reflector. Reduced thermal load at the light beam. Direct beam bulbs (no cool beam): Thermal load at the light beam, therefore almost no heat development at the rear side of the reflector.	

Electromagnetic compatibility 

Product tested for **electromagnetic compatibility** by the VDE (radio protected sign).

Product **VDE tested** 



Product **KEMA tested** (Netherlands) 

High-efficiency **professional lamp** for commercial applications. **PROFILIGHT** 

This lamp is equipped with energy-saving **LED technique**. 

Product **ENEC tested** 

(Indicates the conformity with the European safety norms)

Product **TÜV-/GS tested**  

Product **Nemco tested** (Norway) 

Product **Semco tested** (Norway) 

This lamp can be operated with **energy-saving bulbs**. 

Information to heat generation at lamp housing:

Halogen bulbs and metal-halide discharge bulbs have a high operating temperature and can cause a heating of the respective lamp housing. The latter can therefore only be touched in cooled condition. Adjustable lamps or lamp heads, which do not have an isolated adjustment handle or where the permissible housing temperature is exceeded at the adjustment point during operation with maximum bulb wattage, must be mounted out of reach of contact. LED Retrofit bulbs are available as low-temperature alternative to most of our halogen bulbs. Suitable solutions can be found in the bulb chapter.

Use above 2,5 m when operating with halogen bulbs, this restriction is not applicable if using LED or energy-saving bulbs.



Use of lamp is only permitted out of reach of contact (above 2,5 m).



LED:

Due to production technical reasons the light colour of LED's amongst each other can differ. The value for light colour and lumen, where indicated, are typical average. We strive to carry out every order with the same colour selection. However, for follow-up orders we cannot guarantee the same colour selection. Detailed technical data sheets on LED strips are available on request.

Power LEDs place increased demands on the power constance and should therefore only be operated with constant power sources. If several LEDs are connected, they must be connected in series. A parallel connection is not permitted. Please note also the installation sequence, so that the LEDs are not temporarily exposed to high currents and thus getting damaged. In principle: first completely connect the secondary electric circuit (LEDs to Driver) and then connect the primary electric circuit (Driver to the power).

Stainless steel 304:

(1.4301) A good corrosion resistance for natural environmental media (water, municipal and rural atmosphere) with the absence of significant chlorine- and salt concentration. 14301 is however not suitable for applications where contact is made with the sea respective sea water or a salty atmosphere. It is also not suitable for applications in swimming pools or resemblance.

Stainless steel 316:

(1.4404) For natural environmental media (water, municipal and rural atmosphere) as well as industrial areas with moderate chlorine and salt concentration, for the food and pharmaceutical industry and for the rural food sector 1.4404 shows an excellent corrosion resistance. It is not saltwater proof.

Please note:

A large part of the products presented in this catalogue are protected by registered trade marks, design patents, utility models or patents. An offence against the patent rights or a usage of text and layout without our permission will be legally pursued. All products of our assortment are subject to a strict quality inspection and fulfill the general valid standards (CE).

The illustrations and data contained in this catalogue are only for illustration and are noncommittal in colour, form, execution and technical data.

All weight and length specifications are indicated in kg and/or in cm, if not differently designated.

Products marked with ▼ are available in limited quantities and may not be available during the entire validity of catalogues.

The presentation of our lights with realistic and exemplary application photos is made possible by the friendly compliancy and consent of the owners or designers of the surroundings seen in the foreground of the pictures. Again we would like to thank everyone who contributed with consent to the appearance and to the use of our photos.

Conception and Design:

Corporate Creative Center, Übach-Palenberg, 2012

Print:

Weiss-Druck GmbH & Co. KG, Monschau

Photography: (according to number of pictures)

Photographic studio CCC, Übach-Palenberg
 Photographic studio Andreas Fein, Cologne
 Photographic studio Gerd Arnolds, Aachen
 Photographic studio Günter Preissler, Stollberg
 MM Video-Fotowerbung, Kaufungen



SLV Elektronik GmbH
Postfach 1249
52527 Übach-Palenberg
Germany

Tel.: +49 (0) 2451 /4833-355
Fax: +49 (0) 2451 /4833-179

Internet: www.slv.de
Products: www.slvbyslv.de
E-mail: export@slv.de